

TABLE OF CONTENTS

1	Before driving	Adjusting and operating features such as door locks, mirrors, and steering column
2	When driving	Driving, stopping and safe-driving information
3	Interior features	Air conditioning and audio systems, as well as other interior features for a comfortable driving experience
4	Maintenance and care	Cleaning and protecting your vehicle, performing do-it-yourself maintenance, and maintenance information
5	When trouble arises	What to do if the vehicle needs to be towed, gets a flat tire, or is involved in an accident
6	Vehicle specifications	Detailed vehicle information
7	For owners	Reporting safety defects for U.S. owners, and seat belt and SRS airbag instructions for Canadian owners
	Index	Alphabetical listing of information contained in this manual

TABLE OF CONTENTS | Index

1 Before driving

1-1. Key information
 Keys 26

1-2. Opening, closing and locking the doors
 Smart key system..... 28
 Wireless remote control 43
 Side doors 48
 Back door 54

1-3. Adjustable components (seats, mirrors, steering wheel)
 Front seats 64
 Rear seats 67
 Head restraints 70
 Seat belts 72
 Steering wheel 79
 Inside rear view mirror 80
 Outside rear view mirrors 82

1-4. Opening and closing the windows and moon roof
 Power windows 85
 Moon roof 89
 Sunshade 92

1-5. Refueling

Opening
 the fuel tank cap 93

1-6. Theft deterrent system

Engine immobilizer
 system 97
 Alarm 100
 Theft prevention labels
 (U.S.A.) 104

1-7. Safety information

Correct driving posture 105
 SRS airbags 107
 Front passenger occupant
 classification system 121
 Child restraint systems 127
 Installing child restraints 133

2 When driving

2-1. Driving procedures

Driving the vehicle 148
 Engine (ignition) switch
 (vehicles with
 smart key system) 159
 Engine (ignition) switch
 (vehicles without
 smart key system) 163
 Automatic transmission 166
 Turn signal lever 171
 Parking brake 172
 Horn 173

2-2. Instrument cluster

Gauges and meters 174
 Indicators and warning lights..... 177
 Multi-information display (TFT type)..... 180
 Multi-information display (LCD type) 194

2-3. Operating the lights and wipers

Headlight switch..... 198
 Automatic High Beam (vehicles with discharge headlights) 202
 Fog light switch 209
 Windshield wipers and washer 210
 Rear window wiper and washer 212

2-4. Using other driving systems

Cruise control..... 213
 Rear view monitor system 217
 Hill-start assist control..... 222
 Driving assist systems 224

2-5. Driving information

Utility vehicle precautions 230
 Cargo and luggage 235
 Vehicle load limits 240
 Winter driving tips 242
 Trailer towing 247
 Dinghy towing 259

3 Interior features

3-1. Using the air conditioning system and defogger

Automatic air conditioning system 262
 Manual air conditioning system 272
 Rear window defogger 278

3-2. Using the audio system

Audio system type 280
 Using the radio 284
 Using the CD player 293
 Playing back MP3 and WMA discs 303
 Operating an iPod 313
 Operating a USB memory 320
 Optimal use of the audio system 328
 Using the AUX port..... 333
 Using the steering switches 334

3-3. Using the Bluetooth® audio system

Bluetooth® audio system.... 338
 Using the Bluetooth® audio system 341
 Operating a Bluetooth® enabled portable Lplayer 348
 Setting up a Bluetooth® enabled portable player.... 350
 Bluetooth® audio system setup 355

TABLE OF CONTENTS | Index

3-4. Using the rear seat entertainment system

Rear seat entertainment system features..... 356

Using the DVD player (DVD video)..... 365

Using the DVD player (video CD)..... 374

Using the DVD player (audio CD/CD text)..... 377

Using the DVD player (MP3 discs) 378

Using the video mode 380

Changing the initial settings 382

3-5. Using the hands-free system (for cellular phone)

Hands-free system (for cellular phone) 391

Using the hands-free system..... 394

Making a phone call 403

Setting a cellular phone..... 409

Security and system setup 416

Using the phone book 421

3-6. Using the interior lights

Interior lights list..... 430

- Personal/interior light main switch..... 431
- Personal/interior lights and luggage compartment light 432

3-7. Using the storage features

List of storage features 434

- Glove box 435
- Console boxes..... 436
- Overhead console 438
- Cup holders 439
- Bottle holders 441
- Auxiliary boxes 442

3-8. Other interior features

Sun visors 445

Vanity mirror 446

Power outlets..... 447

Seat heaters 450

Armrest..... 452

Floor mats..... 453

Luggage compartment features 455

Garage door opener 457

Compass 464

4 Maintenance and care

4-1. Maintenance and care

- Cleaning and protecting the vehicle exterior..... 470
- Cleaning and protecting the vehicle interior..... 473

4-2. Maintenance

- Maintenance requirements..... 476
- General maintenance..... 478
- Emission inspection and maintenance (I/M) programs..... 481

4-3. Do-it-yourself maintenance

- Do-it-yourself service precautions 482
- Hood 486
- Positioning a floor jack 488
- Engine compartment..... 490
- Tires 506
- Tire inflation pressure 513
- Wheels 517
- Air conditioning filter..... 520
- Key battery 523
- Checking and replacing fuses..... 527
- Light bulbs..... 537

5 When trouble arises

5-1. Essential information

- Emergency flashers..... 550
- If your vehicle needs to be towed..... 551
- If you think something is wrong..... 555
- If noise can be heard from under vehicle..... 556
- Fuel pump shut off system 557
- Event data recorder..... 558

5-2. Steps to take in an emergency

- If a warning light turns on or a warning buzzer sounds... 560
- If a warning message is displayed 575
- If you have a flat tire 576
- If the engine will not start 587
- If the shift lever cannot be shifted from "P"..... 590
- If you lose your keys..... 591
- If the electronic key does not operate properly (vehicles with smart key system)..... 592
- If the battery is discharged..... 595
- If your vehicle overheats 600
- If the vehicle becomes stuck 603
- If your vehicle has to be stopped in an emergency..... 605

TABLE OF CONTENTS | Index

6 Vehicle specifications

6-1. Specifications

Maintenance data
(fuel, oil level, etc.) 608
Fuel information 622
Tire information 625

6-2. Customization

Customizable features 640

6-3. Initialization

Items to initialize..... 647

Index

Abbreviation list 666
Alphabetical index 668
What to do if..... 676

7 For owners

Reporting safety defects
for U.S. owners 650
Seat belt instructions
for Canadian owners
(in French)..... 651
SRS airbag instructions
for Canadian owners
(in French)..... 653

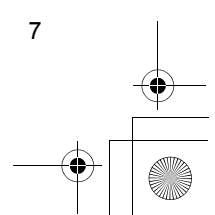
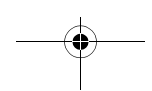
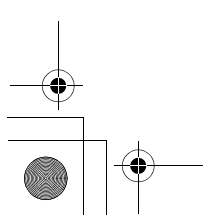
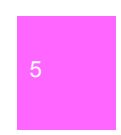
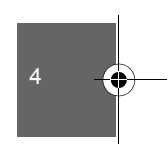
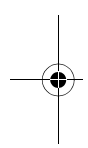
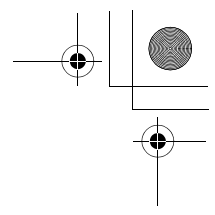
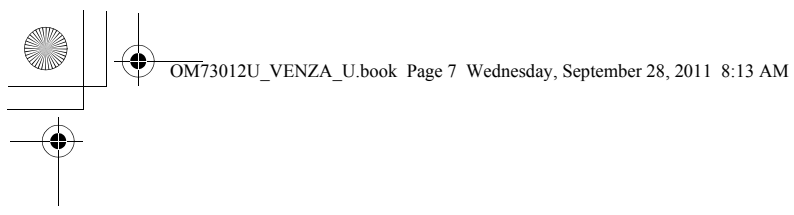

Pictorial index

Exterior

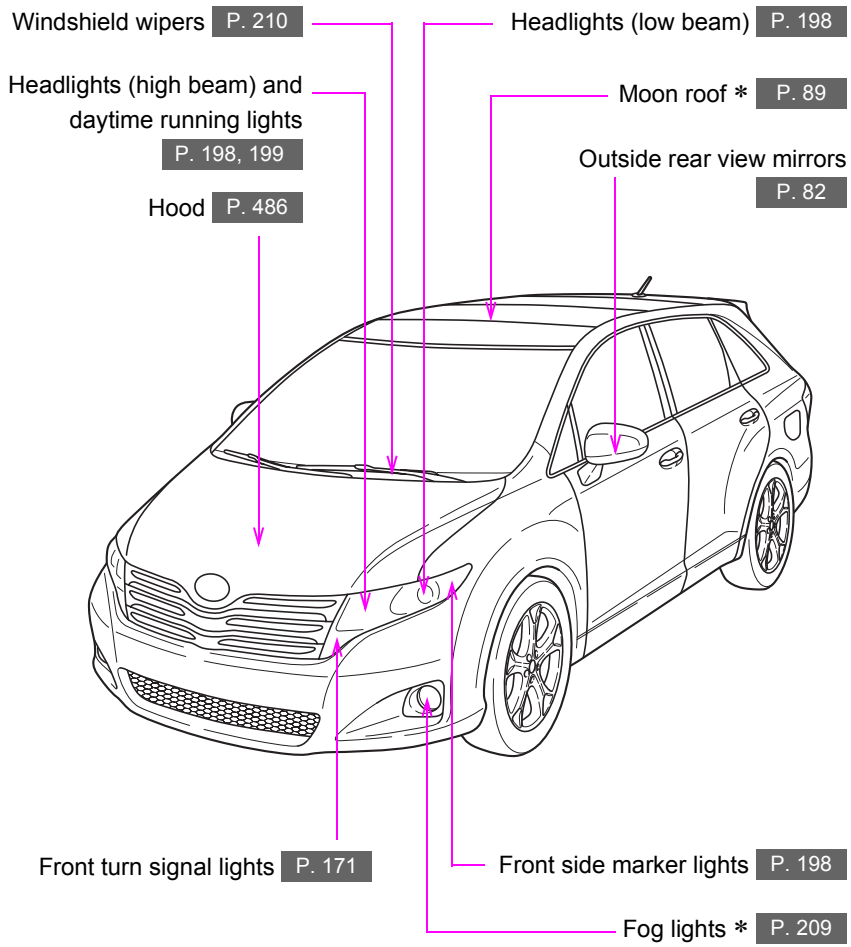

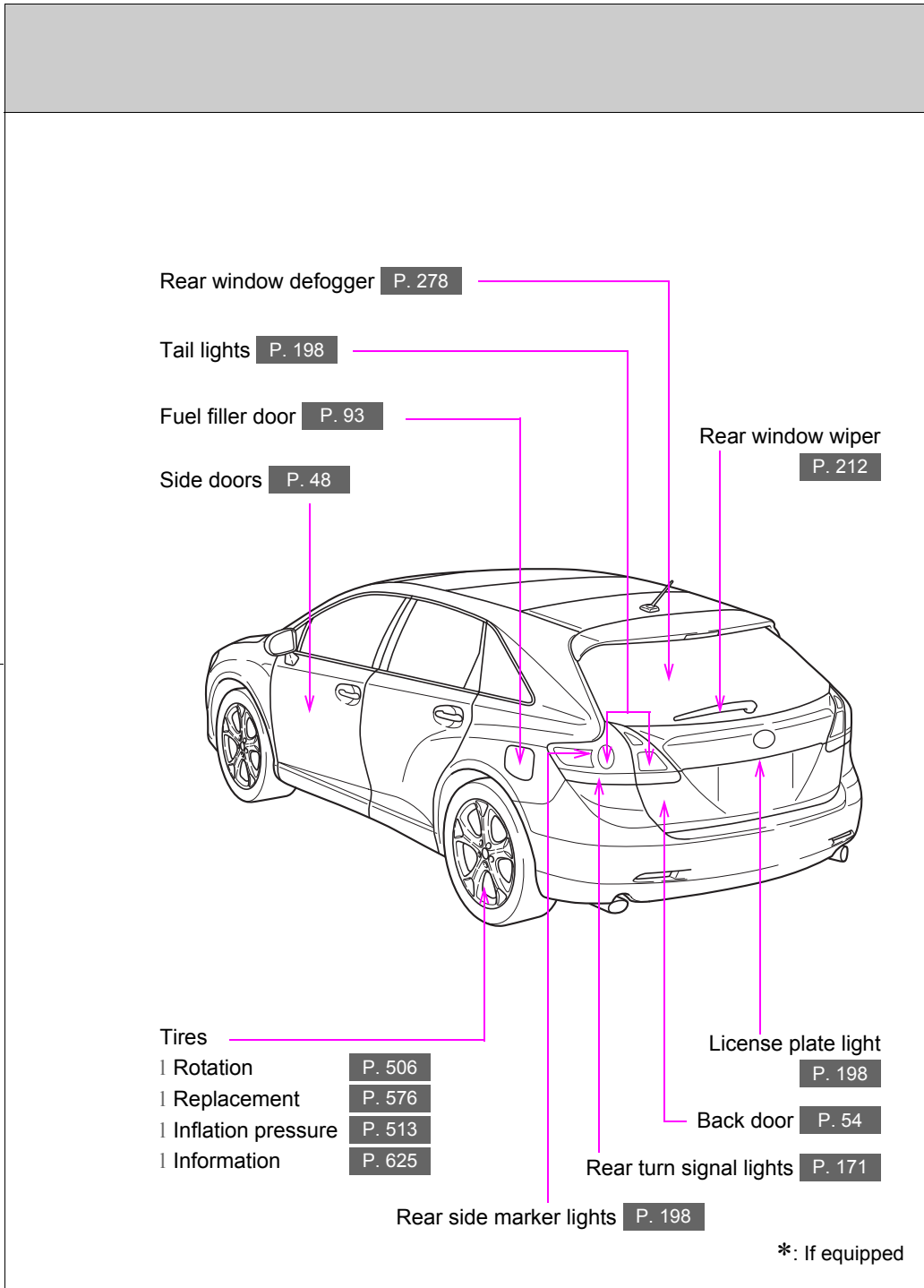

Pictorial index

Interior

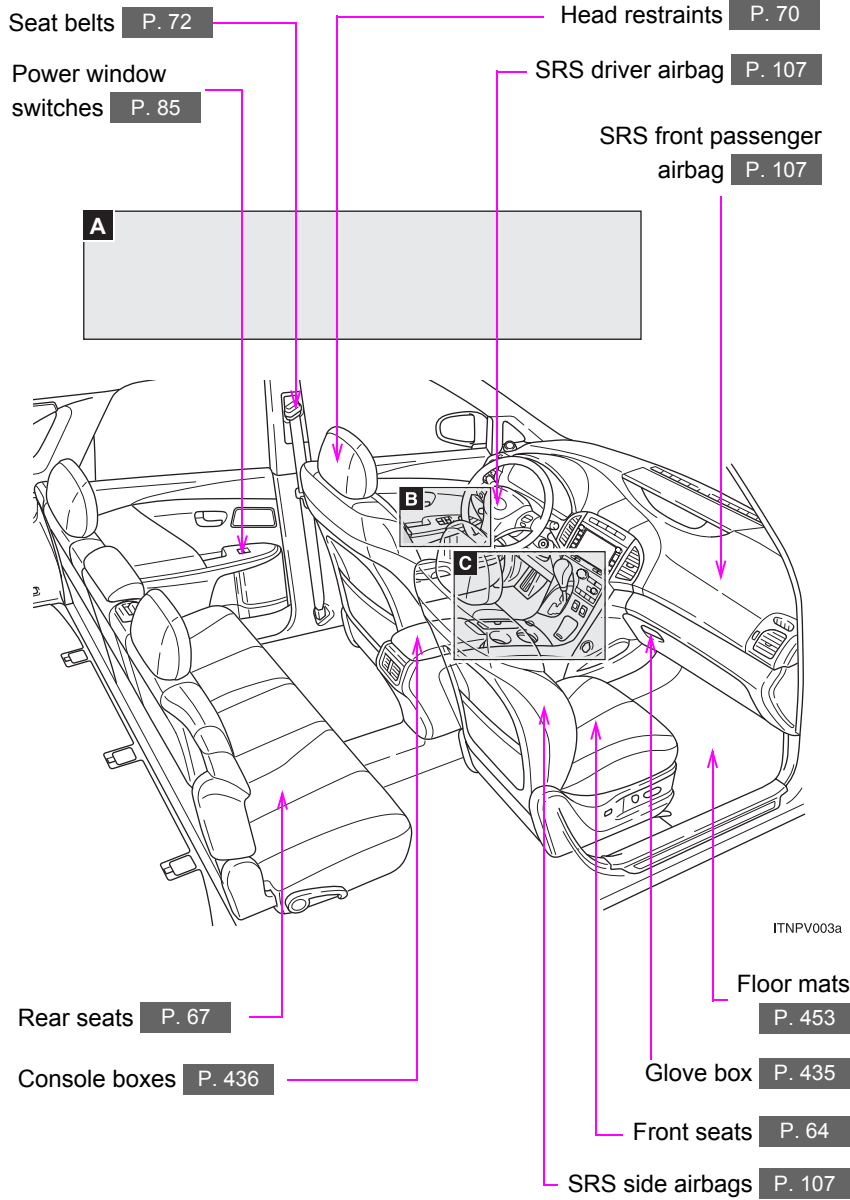

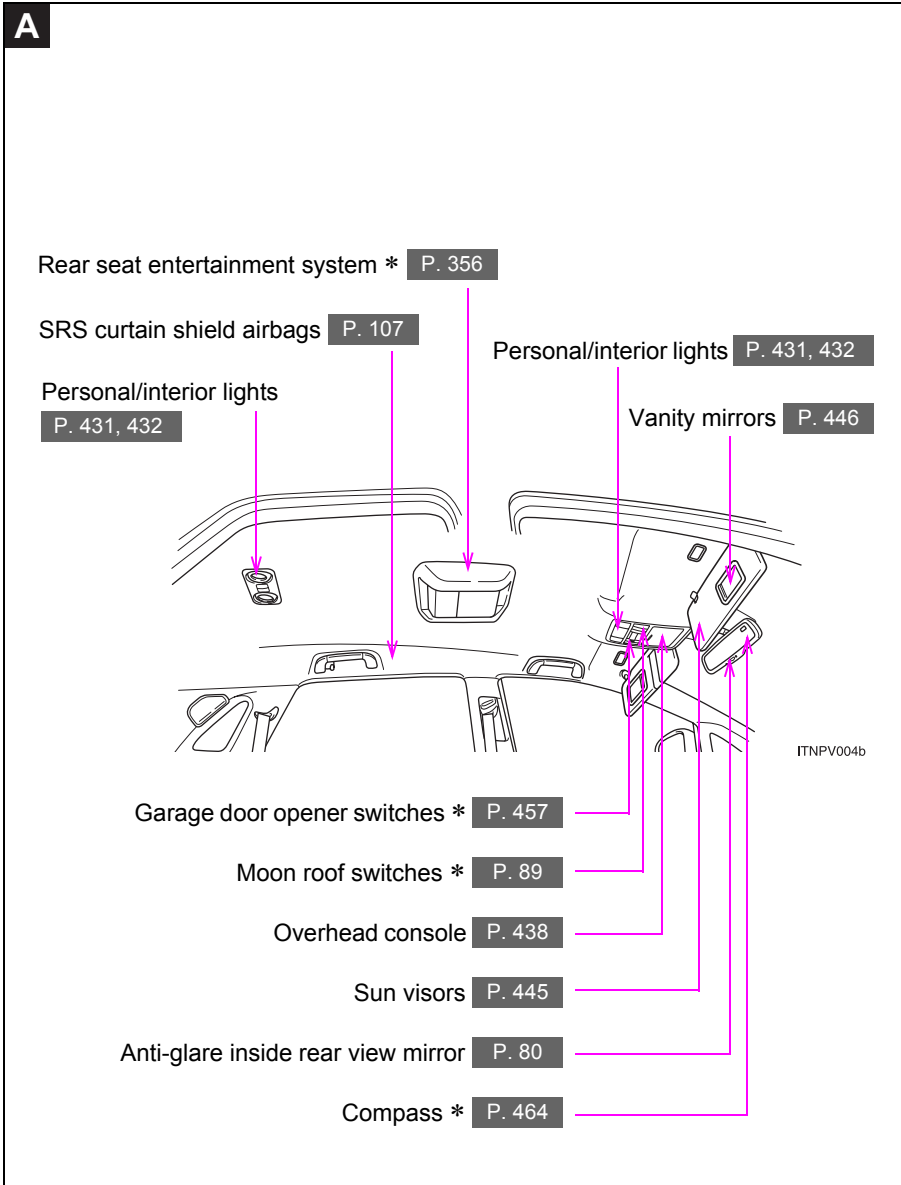

*: If equipped

Pictorial index

Interior

B

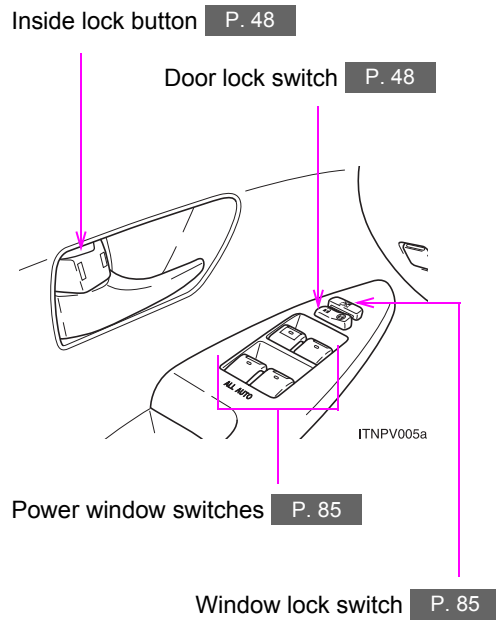

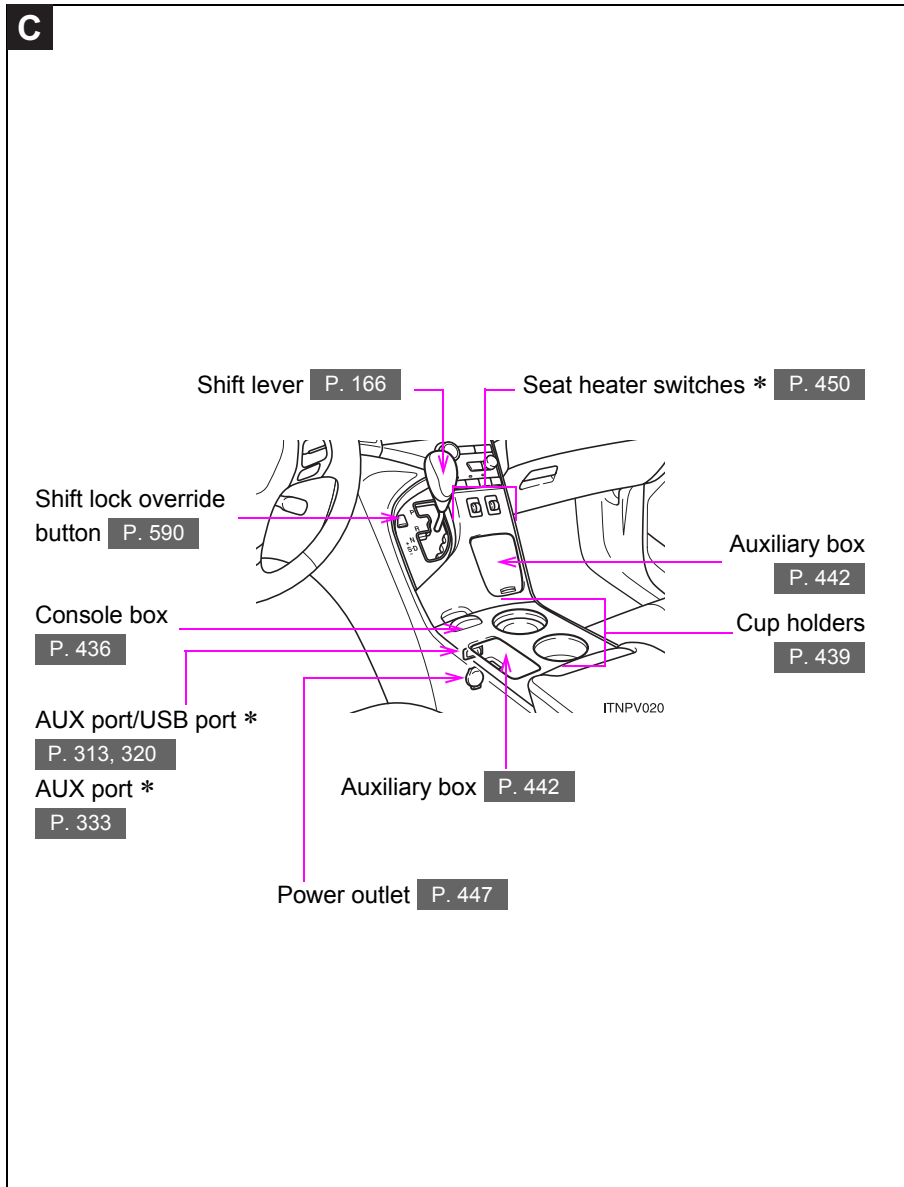

*: If equipped

Pictorial index

Instrument panel

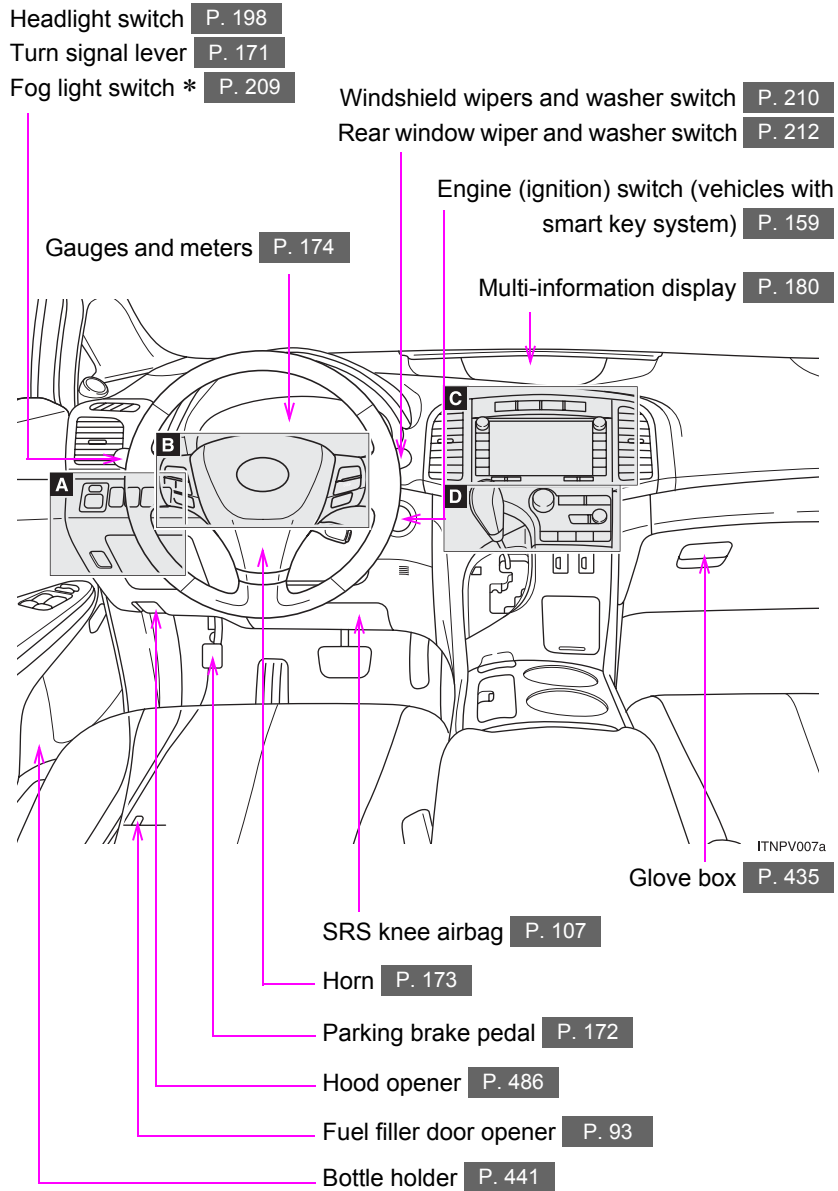

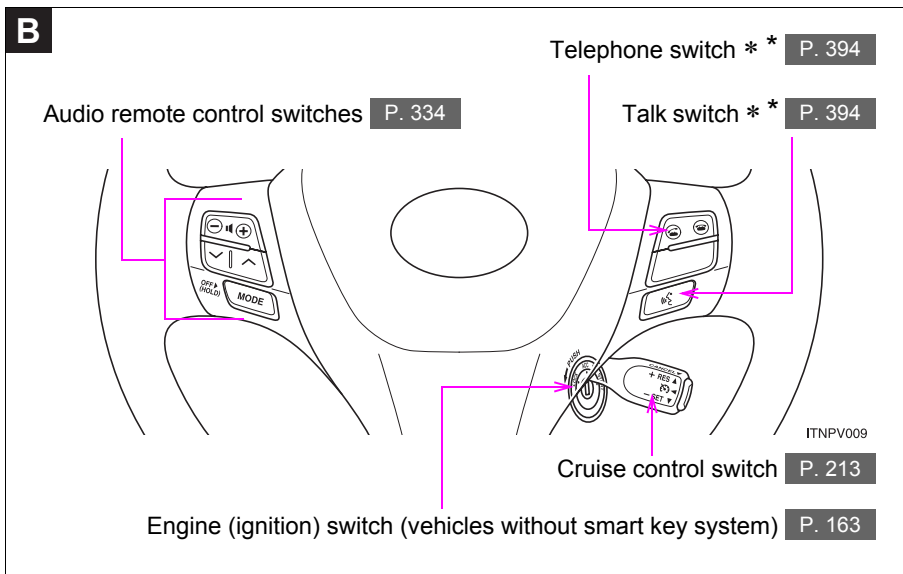
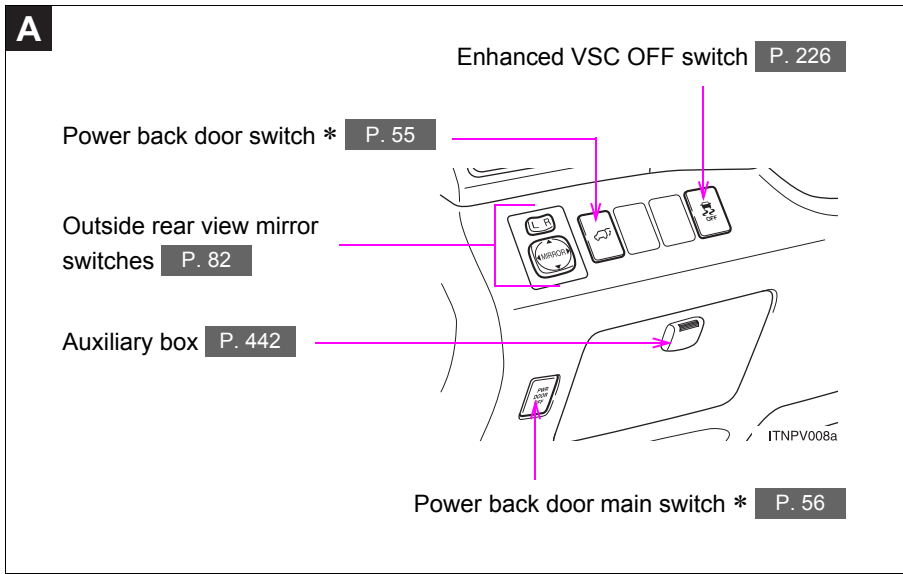

*: If equipped
*: Refer to "Navigation System Owner's Manual".

Pictorial index

Instrument panel

C

► With navigation system

Emergency flasher switch P. 550

Multi-information display switches P. 180, 194

Audio/navigation system *

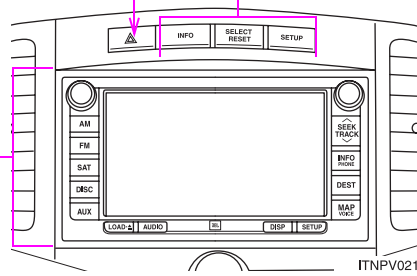

► Without navigation system

Emergency flasher switch P. 550

Multi-information display switches P. 180, 194

Audio system P. 280

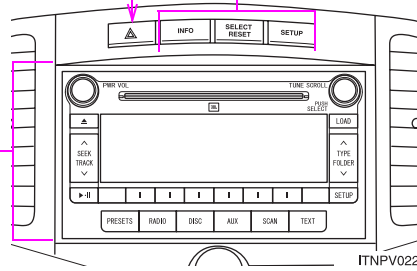

D

► With automatic air conditioning system

Air conditioning system **P. 262**

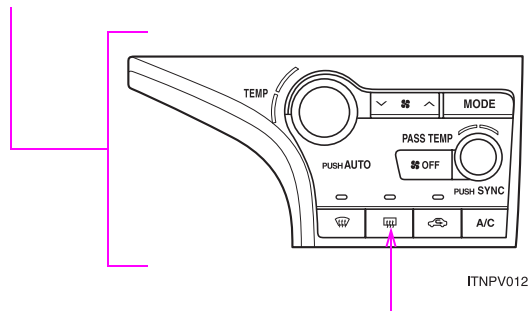

ITNPV012

Rear window defogger switch **P. 278**

► With manual air conditioning system

Air conditioning system **P. 272**

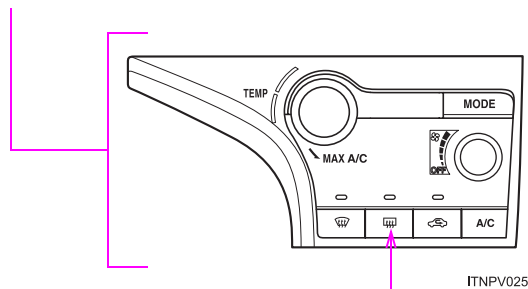

ITNPV025

Rear window defogger switch **P. 278**

*: Refer to "Navigation System Owner's Manual".

Pictorial index

Luggage compartment

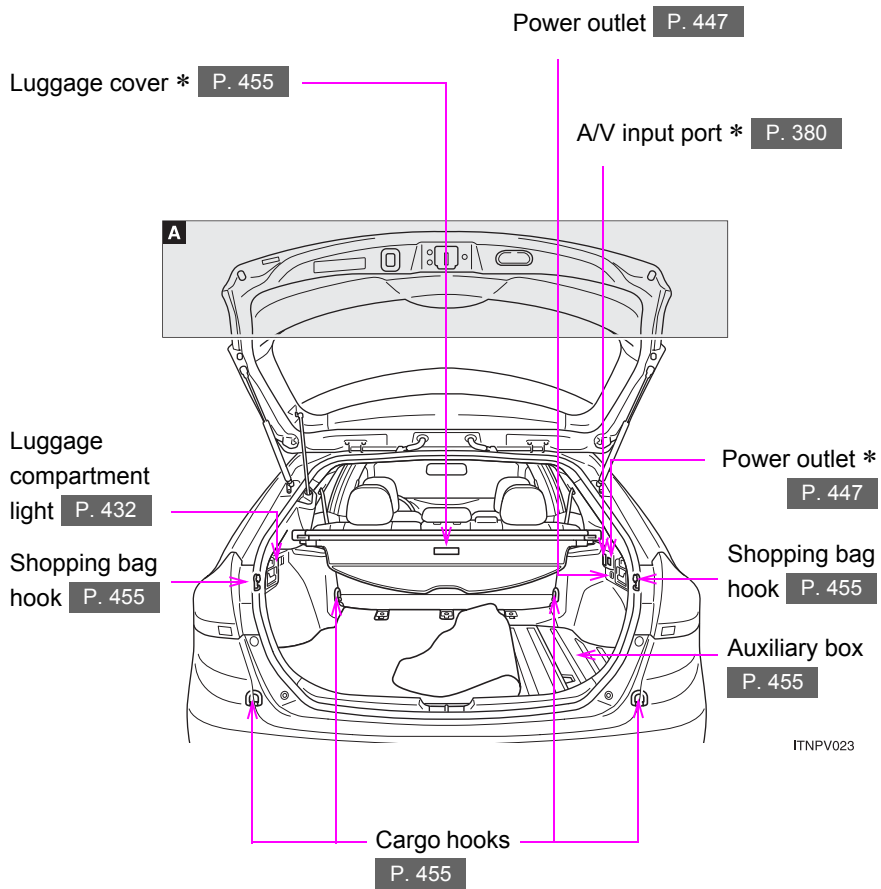

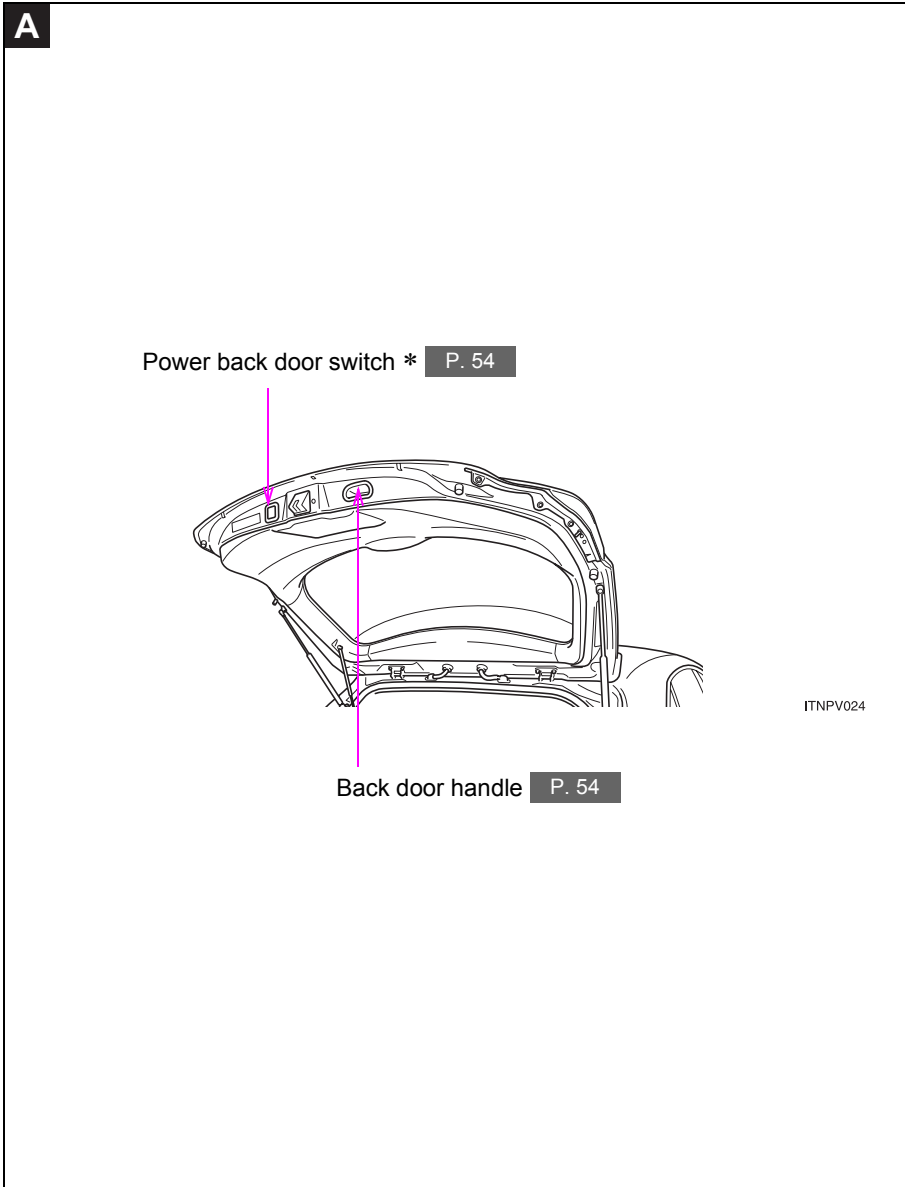

ITNPV024

*: If equipped

For your information

Main Owner's Manual

Please note that this manual applies to all models and explains all equipment, including options. Therefore, you may find some explanations for equipment not installed on your vehicle.

All specifications provided in this manual are current at the time of printing. However, because of the Toyota policy of continual product improvement, we reserve the right to make changes at any time without notice.

Depending on specifications, the vehicle shown in the illustration may differ from your vehicle in terms of equipment.

Accessories, spare parts and modification of your Toyota

A wide variety of non-genuine spare parts and accessories for Toyota vehicles are currently available in the market. You should know that Toyota does not warrant these products and is not responsible for their performance, repair, or replacement, or for any damage they may cause to, or adverse effect they may have on, your Toyota vehicle.

This vehicle should not be modified with non-genuine Toyota products. Modification with non-genuine Toyota products could affect its performance, safety or durability, and may even violate governmental regulations. In addition, damage or performance problems resulting from the modification may not be covered under warranty.

Installation of a mobile two-way radio system

As the installation of a mobile two-way radio system in your vehicle could affect electronic systems such as the multi-port fuel injection system/sequential multi-port fuel injection system, cruise control system, anti-lock brake system, SRS airbag system and seat belt pretensioner system, be sure to check with your Toyota dealer for precautionary measures or special instructions regarding installation.

Unwanted noise may occur in the reception of the mobile two-way radio.

Scrapping of your Toyota

The SRS airbag and seat belt pretensioner devices in your Toyota contain explosive chemicals. If the vehicle is scrapped with the airbags and seat belt pretensioners left as they are, this may cause an accident such as fire. Be sure to have the systems of the SRS airbag and seat belt pretensioner removed and disposed of by a qualified service shop or by your Toyota dealer before you scrap your vehicle.

Perchlorate Material

Special handling may apply,
See www.dtsc.ca.gov/hazardouswaste/perchlorate.
Your vehicle has components that may contain perchlorate. These components may include airbag, seat belt pretensioners, and wireless remote control batteries.

 **CAUTION**

n General precautions while driving

Driving under the influence: Never drive your vehicle when under the influence of alcohol or drugs that have impaired your ability to operate your vehicle. Alcohol and certain drugs delay reaction time, impair judgment and reduce coordination, which could lead to an accident that could result in death or serious injury.

Defensive driving: Always drive defensively. Anticipate mistakes that other drivers or pedestrians might make and be ready to avoid accidents.

Driver distraction: Always give your full attention to driving. Anything that distracts the driver, such as adjusting controls, talking on a cellular phone or reading can result in a collision with resulting death or serious injury to you, your occupants or others.

n General precaution regarding children's safety

Never leave children unattended in the vehicle, and never allow children to have or use the key.

Children may be able to start the vehicle or shift the vehicle into neutral. There is also a danger that children may injure themselves by playing with the cigarette lighter, the windows, the moon roof, or other features of the vehicle. In addition, heat build-up or extremely cold temperatures inside the vehicle can be fatal to children.

Symbols used throughout this manual

Cautions & Notices

CAUTION

This is a warning against anything which may cause injury to people if the warning is ignored. You are informed about what you must or must not do in order to reduce the risk of injury to yourself and others.

NOTICE

This is a warning against anything which may cause damage to the vehicle or its equipment if the warning is ignored. You are informed about what you must or must not do in order to avoid or reduce the risk of damage to your Toyota and its equipment.

Symbols used in illustrations



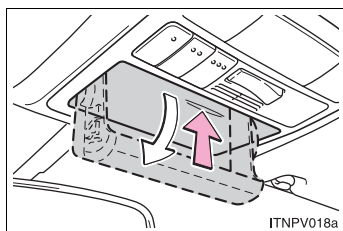

Safety symbol

The symbol of a circle with a slash through it means “Do not”, “Do not do this”, or “Do not let this happen”.



Arrows indicating operations

-  Indicates the action (pushing, turning, etc.) used to operate switches and other devices.
-  Indicates the outcome of an operation (e.g. a lid opens).

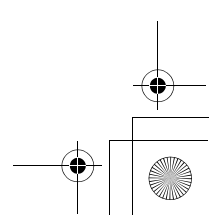
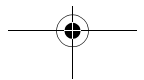
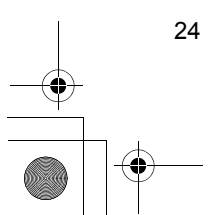
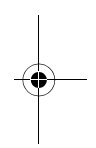
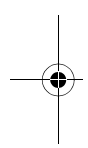
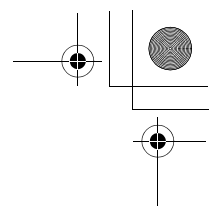
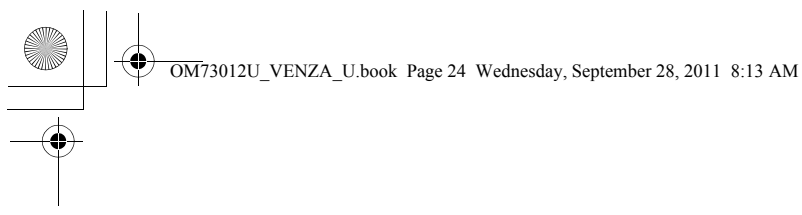

Before driving

1

1-1. Key information

Keys 26

1-2. Opening, closing and locking the doors

Smart key system 28
Wireless remote control 43
Side doors 48
Back door 54

1-3. Adjustable components (seats, mirrors, steering wheel)

Front seats 64
Rear seats 67
Head restraints 70
Seat belts 72
Steering wheel 79
Inside rear view mirror 80
Outside rear view mirrors 82

1-4. Opening and closing the windows and moon roof

Power windows 85
Moon roof 89
Sunshade 92

1-5. Refueling

Opening the fuel tank cap 93

1-6. Theft deterrent system

Engine immobilizer system 97
Alarm 100
Theft prevention labels (U.S.A.) 104

1-7. Safety information

Correct driving posture 105
SRS airbags 107
Front passenger occupant classification system 121
Child restraint systems 127
Installing child restraints 133

1-1. Key information

Keys

The following keys are provided with the vehicle.

► Vehicles with smart key system

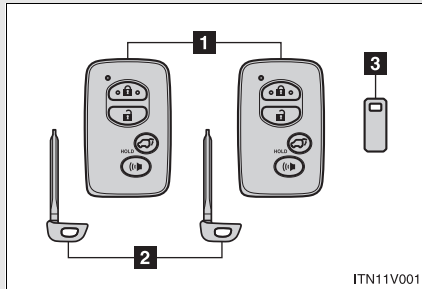

1 Electronic keys

- Operating the smart key system (→P. 28)
- Operating the wireless remote control function (→P. 43)

2 Mechanical keys

3 Key number plate

► Vehicles without smart key system

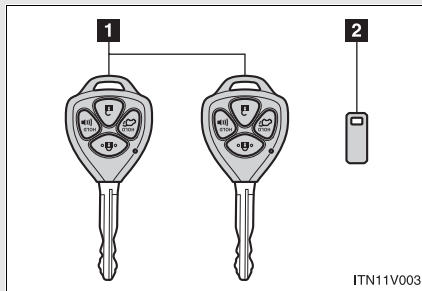

1 Keys

Operating the wireless remote control function (→P. 43)

2 Key number plate

Using the mechanical key (vehicles with smart key system)

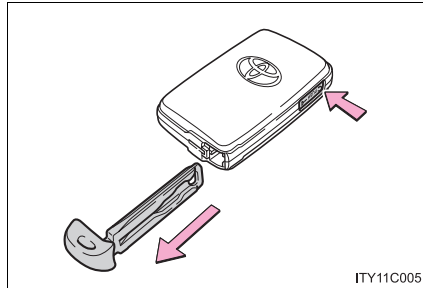

Take out the mechanical key.

After using the mechanical key, store it in the electronic key. Carry the mechanical key together with the electronic key. If the electronic key battery depletes or entry function does not operate properly, you will need the mechanical key. (→P. 592)

1

Before driving

n Key number plate

Keep the plate in a safe place such as your wallet, not in the vehicle. In the event that a key is lost, a new key can be made at your Toyota dealer using the key number plate. (→P. 591)

n When riding in an aircraft

When bringing a key onto an aircraft, make sure you do not press any buttons on the key while inside the aircraft cabin. If you are carrying a key in your bag etc., ensure that the buttons are not likely to be pressed accidentally. Pressing a button may cause the key to emit radio waves that could interfere with the operation of the aircraft.

⚠ NOTICE

n To prevent key damage

- ! Do not subject the keys to strong shocks, expose them to high temperatures by placing them in direct sunlight, or get them wet.
- ! Do not expose the keys to electromagnetic materials or attach any material that blocks electromagnetic waves to the key surface.
- ! Do not disassemble the key.

1-2. Opening, closing and locking the doors Smart key system*

The following operations can be performed simply by carrying the electronic key on your person, for example in your pocket.
(The driver should always carry the electronic key.)

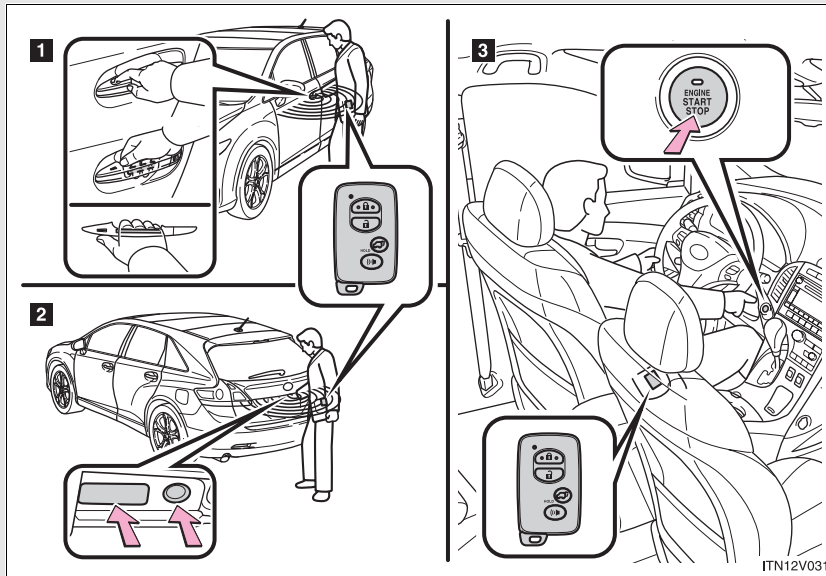

- 1** Locks and unlocks the doors (→P. 29)
- 2** Locks and unlocks the doors (→P. 29)
- 3** Starts and stops the engine (→P. 159)

*: If equipped

1-2. Opening, closing and locking the doors

Unlocking and locking the doors

► Side door handle

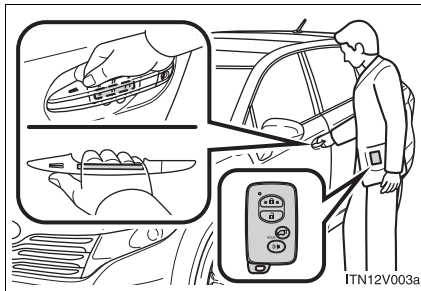

Grip the handle to unlock the doors.

Make sure to touch the sensor on the back of the handle.

The doors cannot be unlocked for 3 seconds after the doors are locked.

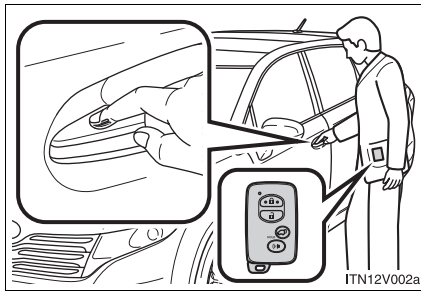

Touch the sensor area to lock the doors.

1

Before driving

1-2. Opening, closing and locking the doors

► Back door

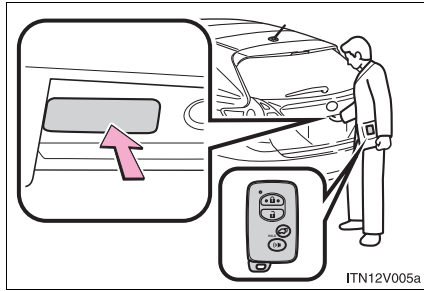

Press the unlock button to unlock the door.

The door cannot be unlocked for 3 seconds after the door is locked.

Lock the back door again when you leave the vehicle. The back door will not lock automatically after it has been opened and then closed.

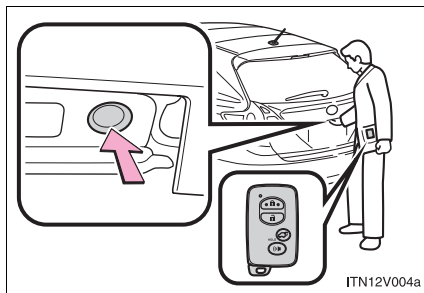

Press the lock button to lock the doors.

1-2. Opening, closing and locking the doors

Antenna location and effective range

Antenna location

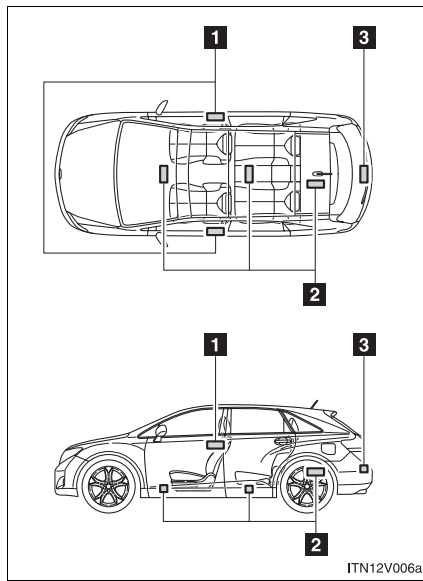

- 1** Antennas outside cabin
- 2** Antennas inside cabin
- 3** Antenna outside luggage compartment

1

Before driving

1-2. Opening, closing and locking the doors

n Effective range (areas within which the electronic key is detected)

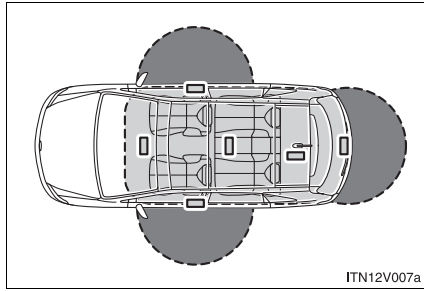

- When locking or unlocking the doors

The system can be operated when the electronic key is within about 2.3 ft. (0.7 m) of an outside door handle.

- When starting the engine or changing “ENGINE START STOP” switch modes

The system can be operated when the electronic key is inside the vehicle.

1-2. Opening, closing and locking the doors

n Operation signals

A buzzer sounds and the emergency flashers flash to indicate that the doors have been locked/unlocked. (Locked: Once; Unlocked: Twice)

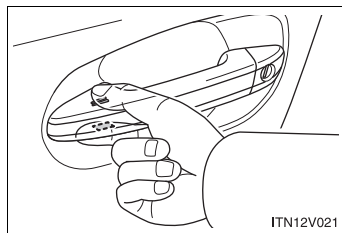
n When the door cannot be locked using the topside sensor area

If the door will not lock even when the topside sensor area is touched, try touching both the topside and underside sensor areas at the same time.

1

Before driving

n Conditions affecting operation

The smart key system uses weak radio waves. In the following situations, the communication between the electronic key and the vehicle may be affected, preventing the smart key system and wireless remote control from operating properly. (Way of coping →P. 592)



- 1 When the electronic key battery is depleted
- 1 Near a TV tower, electric power plant, gas station, radio station, large display, airport or other facility that generates strong radio waves or electrical noise
- 1 When carrying a portable radio, cellular phone, cordless phone or other wireless communication devices
- 1 When the electronic key has come into contact with, or is covered by a metallic object
- 1 When multiple electronic keys are in the vicinity
- 1 When carrying or using the electronic key together with the following devices that emit radio waves
 - Another vehicle's electronic key
 - A wireless key that emits radio waves
 - Personal computer
- 1 If window tint with a metallic content or metallic objects are attached to the rear window

1-2. Opening, closing and locking the doors



n Switching the door unlock function

It is possible to set which doors the entry function unlocks.

STEP 1 Turn the “ENGINE START STOP” switch OFF.

STEP 2 When the indicator on the key surface is turned off, press and hold  or  for approximately 5 seconds while pressing  on the key.

The setting changes each time an operation is performed, as shown below. (When changing the setting continuously, release the buttons, wait for at least 5 seconds, and repeat **STEP 2**.)

Multi-information display (TFT type only)	Unlocking function	Beep
	Hold the driver's door handle to unlock only the driver's door.	Exterior: Beeps three times Interior: Pings once
	Hold the front passenger's door handle to unlock all doors.	
	Hold either front door handle to unlock all doors.	Exterior: Beeps twice Interior: Pings once

STEP 3 For vehicles equipped with an alarm, unlock the doors using the wireless remote control and open one of the doors.

If a door is not opened within 60 seconds after  is pressed, the doors will be locked again and the alarm will automatically be set. In case that the alarm is triggered, immediately stop the alarm. (→P. 100)

1-2. Opening, closing and locking the doors

n **Battery-saving function**

In the following circumstances, the entry function is disabled in order to prevent the vehicle and electronic key batteries from discharging.

- l When the entry function has not been used for 2 weeks or more
- l When the electronic key has been left within approximately 3 ft. (1 m) of the vehicle for 10 minutes or more

The system will resume operation when...

- l The vehicle is locked using the door handle lock switch.
- l The vehicle is locked/unlocked using the wireless remote control function (→P. 43) or the mechanical key. (→P. 592)

n **Electronic key battery depletion**

- l The standard battery life is 1 to 2 years. (The battery becomes depleted even if the electronic key is not used.) If the smart key system or the wireless remote control function does not operate, or the detection area becomes smaller, the battery may be depleted. Replace the battery when necessary. (→P. 523)
- l If the battery becomes low, an alarm will sound in the cabin when the engine stops. (→P. 38)
- l To avoid serious deterioration, do not leave the electronic key within 3 ft. (1 m) of the following electrical appliances that produce a magnetic field.
 - TVs
 - Personal computers
 - Recharging cellular phones or cordless phones
 - Table lamps

1

Before driving

1-2. Opening, closing and locking the doors

n To operate the system properly

Make sure to carry the electronic key when operating the system. Do not get the electronic key too close to the vehicle when operating the system from outside of the vehicle.

Depending on the position and holding condition of the electronic key, the key may not be detected correctly and the system may not operate properly. (The alarm may go off accidentally, or the door lock prevention may not function.)

n Note for the entry function

l Even when the electronic key is within the effective range (detection areas), the system may not operate properly in the following cases.

- The electronic key is too close to the window or outside door handle, near the ground, or in a high place when the doors are locked or unlocked.
- The electronic key is near the ground or in a high place, or too close to the rear bumper center when the back door is locked or unlocked.
- The electronic key is on the instrument panel, floor or in the glove box when the engine is started or "ENGINE START STOP" switch modes are changed.

l As long as the electronic key is within the effective range, the doors may be locked or unlocked by anyone.

1-2. Opening, closing and locking the doors

- 1 Even if the electronic key is not inside the vehicle, it may be possible to start the engine if the electronic key is near the window.
- 1 The doors may unlock or lock if a large amount of water splashes on the door handle, such as in the rain or in a car wash when the electronic key is within the effective range. (The doors will automatically be locked after approximately 60 seconds if the doors are not opened and closed.)
- 1 If the key is kept near the vehicle while it is being washed, water applied to a door handle may cause the door to lock and unlock repeatedly. In this event, place the key in a location 6 ft. (2 m) or more from the vehicle, taking care not to lose the key.
- 1 If the key is inside the vehicle while it is being washed, water applied to a door handle may cause a buzzer to sound. In this event, locking all doors will cause the buzzer to stop sounding.
- 1 It may not be possible to lock the doors if the sensor area is covered by mud, ice, snow etc. In this event, try locking again after cleaning the area, or lock by touching the sensor area on the underside of the door handle.
- 1 Gripping the door handle when wearing a glove may not unlock or lock the door.
- 1 If the wireless remote control is used to lock the doors when the electronic key is near the vehicle, there is a possibility that the door may not be unlocked by the smart key system. (Use the wireless remote control to unlock the doors.)
- 1 A sudden approach to the effective range or door handle operation may prevent the doors from being unlocked. In this case, return the door handle to the original position and check that the doors unlock before pulling the door handle.

1

Before driving

1-2. Opening, closing and locking the doors

n **When the vehicle is not driven for extended periods**

To prevent theft of the vehicle, do not leave the electronic key within 6 ft. (2 m) of the vehicle.

n **Security feature**

If a door is not opened within approximately 60 seconds after the vehicle is unlocked, the security feature automatically locks the vehicle again.

n **Alarms and warning indicators**

A combination of exterior and interior alarms as well as warnings displayed on the multi-information display are used to prevent theft of the vehicle and unforeseeable accidents resulting from erroneous operation. Perform the appropriate correction procedure described in the following table.

Alarm	Situation	Correction procedure
Exterior alarm sounds once for 10 seconds	An attempt was made to lock the doors using the entry function while the electronic key was still inside the passenger compartment	Retrieve the electronic key from the passenger compartment and lock the doors again
Exterior alarm sounds once for 10 seconds	An attempt was made to exit the vehicle and lock the doors without first turning the "ENGINE START STOP" switch OFF	Turn the "ENGINE START STOP" switch OFF and lock the doors again
Exterior alarm sounds once for 10 seconds	An attempt was made to lock the vehicle while a door is open	Close all of the doors and lock the doors again

1-2. Opening, closing and locking the doors

Alarm	Situation	Correction procedure
Interior alarm pings continuously*1	The "ENGINE START STOP" switch was turned to ACCESSORY mode while the driver's door was open (or the driver's door was opened while the "ENGINE START STOP" switch was in ACCESSORY mode)	Turn the "ENGINE START STOP" switch OFF and close the driver's door
	The "ENGINE START STOP" switch was turned OFF while the driver's door was open	Close the driver's door
Interior alarm sounds continuously*1	When the "ENGINE START STOP" switch is in IGNITION ON or ACCESSORY mode, an attempt was made to open the door and exit the vehicle, and the shift lever was not in "P"	Shift the shift lever to "P" and turn the "ENGINE START STOP" switch OFF
Interior and exterior alarms sound continuously*1	When the "ENGINE START STOP" switch is in IGNITION ON or ACCESSORY mode, the driver's door was closed after the key was carried outside the vehicle, and the shift lever not in "P"	Shift the shift lever to "P", turn the "ENGINE START STOP" switch OFF and close the driver's door again

1

Before driving

1-2. Opening, closing and locking the doors

Alarm	Situation	Correction procedure
Interior alarm pings once* ¹	The electronic key has a low battery	Replace the electronic key battery
	An attempt was made to start the engine without the electronic key being present, or the electronic key was not functioning normally	Start the engine with the electronic key present* ²
Interior alarm pings once and exterior alarm sounds 3 times* ¹	The driver's door was closed after the key was carried outside the vehicle, and the "ENGINE START STOP" switch was not turned OFF	Turn the "ENGINE START STOP" switch OFF and close the driver's door again
	An occupant carried the electronic key outside the vehicle and closed the door while the "ENGINE START STOP" switch was not OFF	Bring the electronic key back into the vehicle

*¹: A message will be shown on the multi-information display in the instrument cluster.

*²: If the engine does not start when the electronic key is inside the vehicle, the electronic key battery may be depleted or there may be difficulties receiving signal from the key. (→P. 592)

1-2. Opening, closing and locking the doors

n **If the smart key system does not operate properly**

- l Locking and unlocking the doors: Use the mechanical key. (→P. 592)
- l Starting the engine (→P. 159)

n **When the electronic key battery is fully depleted**

→P. 523

n **Customization that can be configured at Toyota dealer or by the TFT type multi-information display**

Settings (e.g. smart key system) can be changed.
(Customizable features →P. 640)

n **Certification for the smart key system**

- ▶ For vehicles sold in the U.S.A.

FCC ID: HYQ14ACX FCC ID: HYQ14ADF
FCC ID: HYQ13CZD FCC ID: HYQ13CZE

NOTE:

This device complies with part 15 of the FCC Rules. Operation is subject to the following two conditions: (1) This device may not cause harmful interference, and (2) this device must accept any interference received, including interference that may cause undesired operation.

FCC WARNING:

Changes or modifications not expressly approved by the party responsible for compliance could void the user's authority to operate the equipment.

1

Before driving

1-2. Opening, closing and locking the doors

- ▶ For vehicles sold in Canada

NOTE:

Operation is subject to the following two conditions: (1) this device may not cause interference, and (2) this device must accept any interference, including interference that may cause undesired operation of the device.

CAUTION

n Caution regarding interference with electronic devices

- I** People with implanted pacemakers or cardiac defibrillators should keep away from the smart key system antennas. (→P. 31)

The radio waves may affect the operation of such devices. If necessary, the entry function can be disabled. Ask your Toyota dealer for details, such as the frequency of radio waves and timing of emitting the radio waves. Then, consult your doctor to see if you should disable the entry function.

- I** Users of any electrical medical device other than implanted pacemakers and implanted cardiac defibrillators should consult the manufacturer of the device for information about its operation under the influence of radio waves. Radio waves could have unexpected effects on the operation of such medical devices.

Ask your Toyota dealer for details for disabling the smart key system.

1-2. Opening, closing and locking the doors Wireless remote control

The wireless remote control can be used to lock and unlock the vehicle from outside the vehicle.

► Vehicles with smart key system

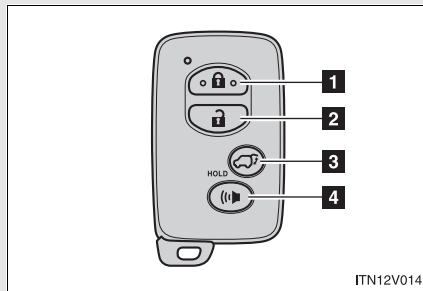

1 Locks all doors

2 Unlocks all doors

Pressing the button unlocks the driver's door. Pressing the button again within 3 seconds unlocks the other doors.

3 Pressing and holding: Opens and closes the power back door (if equipped)

4 Pressing and holding: Sounds alarm (→P. 100)

1

Before driving

1-2. Opening, closing and locking the doors

► Vehicles without smart key system

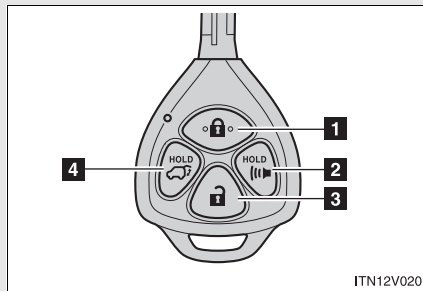

1 Locks all doors

2 Pressing and holding:
Sounds alarm (→P. 100)

3 Unlocks all doors

Pressing the button unlocks the driver's door. Pressing the button again within 3 seconds unlocks the other doors.

4 Pressing and holding:
Opens and closes the power back door (if equipped)

ii Operation signals

Doors: A buzzer sounds and the emergency flashers flash to indicate that the doors have been locked/unlocked. (Locked: Once; Unlocked: Twice)

Back door: A buzzer sounds and the emergency flashers flash twice to indicate that the back door has been opened/closed.

1-2. Opening, closing and locking the doors

n **Door lock buzzer**

If a door or back door is not fully closed, a buzzer sounds continuously for 10 seconds if an attempt to lock the door is made. Fully close the door to stop the buzzer, and lock the vehicle once more.

n **Security feature**

→P. 38

n **Alarm**

Using the wireless remote control to lock the door will set the alarm system. (→P. 100)

n **Key battery depletion**

▶ Vehicles with smart key system

→P. 523

▶ Vehicles without smart key system

The standard battery life is 1 to 2 years. (The battery becomes depleted even if the key is not used.) If the wireless remote control function does not operate, the battery may be depleted. Replace the battery when necessary. (→P. 523)

n **If the wireless remote control does not operate properly**

▶ Vehicles with smart key system

l Locking and unlocking the doors: Use the mechanical key. (→P. 592)

l Starting the engine (→P. 159)

▶ Vehicles without smart key system

Locking and unlocking the doors: Use the key. (→P. 48)

1

Before driving

1-2. Opening, closing and locking the doors

n **Conditions affecting operation**

▶ Vehicles with smart key system

→P. 33

▶ Vehicles without smart key system

The wireless remote control function may not operate normally in the following situations.

!Near a TV tower, radio station, electric power plant, airport or other facility that generates strong radio waves

!When carrying a portable radio, cellular phone or other wireless communication device

!When multiple wireless keys are in the vicinity

!When the wireless key has come into contact with, or is covered by a metallic object

!When a wireless key (that emits radio waves) is being used nearby

!When the wireless key has been left near an electrical appliance such as a personal computer

n **Customization that can be configured at Toyota dealer or by the TFT type multi-information display**

Settings (e.g. 2-step unlocking function) can be changed.
(Customizable features →P. 640)

n **Reversing the operation of the power back door**

Pressing the wireless remote control switch again while the power back door is operating will cause the operation to reverse. However, the reverse operation cannot be performed for the first second after automatic operation starts, even if the wireless remote control switch is pressed again.

1-2. Opening, closing and locking the doors

n Certification for wireless remote control

- For vehicles sold in the U.S.A.

NOTE:

This device complies with Part 15 of the FCC Rules. Operation is subject to the following two conditions: (1) this device may not cause harmful interference, and (2) this device must accept any interference received, including interference that may cause undesired operation.

NOTICE:

This equipment has been tested and found to comply with the limits for a Class B digital device, pursuant to Part 15 of the FCC Rules. These limits are designed to provide reasonable protection against harmful interference in a residential installation. This equipment generates, uses and can radiate radio frequency energy and, if not installed and used in accordance with the instructions, may cause harmful interference to radio communications. However, there is no guarantee that interference will not occur in a particular installation. If this equipment does cause harmful interference to radio or television reception, which can be determined by turning the equipment off and on, the user is encouraged to try to correct the interference by one or more of the following measures:

- 1 Reorient or relocate the receiving antenna.
- 1 Increase the separation between the equipment and receiver.
- 1 Connect the equipment into an outlet on a circuit different from that to which the receiver is connected.
- 1 Consult the dealer or an experienced radio/TV technician for help.

FCC WARNING:

Changes or modifications not expressly approved by the party responsible for compliance could void the user's authority to operate the equipment.

- For vehicles sold in Canada

NOTE:

Operation is subject to the following two conditions: (1) this device may not cause interference, and (2) this device must accept any interference, including interference that may cause undesired operation of the device.

1

Before driving

1-2. Opening, closing and locking the doors

Side doors

The vehicle can be locked and unlocked using the entry function, wireless remote control, key or door lock switch.

n **Entry function (vehicles with smart key system)**

→P. 28

n **Wireless remote control**

→P. 43

n **Key**

▶ Vehicles with smart key system

The doors can also be locked and unlocked with the mechanical key. (→P. 592)

▶ Vehicles without smart key system

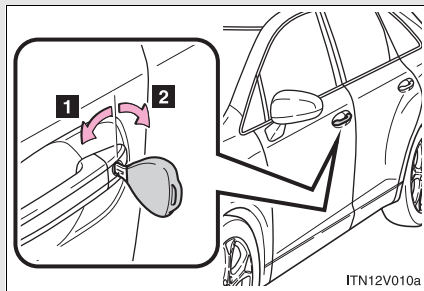

1 Locks all doors

2 Unlocks all doors

Turning the key unlocks the driver's door. Turning the key again within 3 seconds unlocks the other doors.

1-2. Opening, closing and locking the doors

▮ Door lock switch

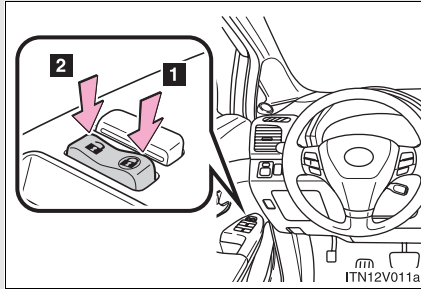

- 1** Locks all doors
- 2** Unlocks all doors

▮ Inside lock button

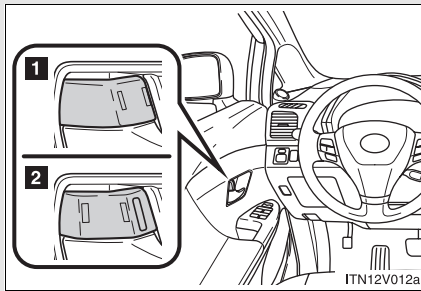

- 1** Locks the door
- 2** Unlocks the door

The front doors can be opened by pulling the inside handles even if the lock buttons are in the lock position.

1

Before driving

1-2. Opening, closing and locking the doors

Locking the driver's doors from the outside without a key

STEP 1 Move the inside lock button to the lock position.

STEP 2 Close the door.

► Vehicles with smart key system

The door cannot be locked if the “ENGINE START STOP” switch is in ACCESSORY or IGNITION ON mode, or the electronic key is left inside the vehicle.

Depending on the position of the electronic key, the key may not be detected correctly and the door may be locked.

► Vehicles without smart key system

The door cannot be locked if either front door is open and the key is in the engine switch.

Rear door child-protector lock

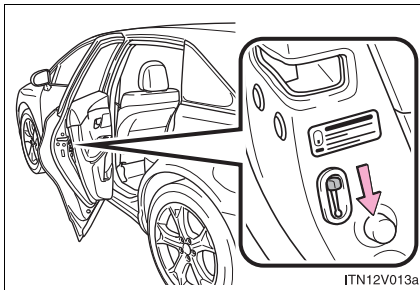

The door cannot be opened from inside the vehicle when the lock is set.

These locks can be set to prevent children from opening the rear doors. Push down on each rear door switch to lock both rear doors.

1-2. Opening, closing and locking the doors

Automatic door locking and unlocking systems

The following functions can be set or canceled:

Function	Operation
Shift position linked door locking function	Shifting the shift lever out of "P" locks all doors.
Shift position linked door unlocking function	Shifting the shift lever to "P" unlocks all doors.
Speed linked door locking function	All doors are locked when the vehicle speed is approximately 12 mph (20 km/h) or higher.
Driver's door linked door unlocking function	All doors are unlocked when the driver's door is opened within 10 seconds after turning the "ENGINE START STOP" switch OFF.

1

Before driving

Setting and canceling the functions

To switch between setting and canceling, follow the procedure below:

► Vehicles with TFT type multi-information display

The function settings can be changed by operating the multi-information display. (→P. 640)

STEP 1 Vehicles with smart key system:

Close all the doors and switch the "ENGINE START STOP" switch to IGNITION ON mode. (Perform **STEP 2** within 20 seconds.)

Vehicles without smart key system:

Close all the doors and switch the engine switch to the "ON" position. (Perform **STEP 2** within 20 seconds.)

1-2. Opening, closing and locking the doors

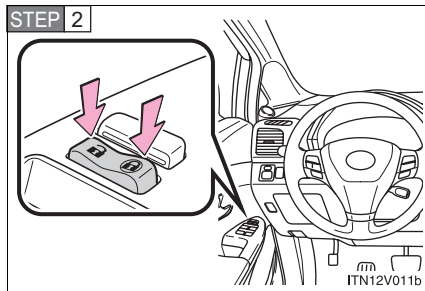

Shift the shift lever to “P” or “N”, press and hold the door lock switch (🔒 or 🔓) for about 5 seconds then release.

The shift lever and switch positions corresponding to the desired function to be set are shown as follows.

Use the same procedure to cancel the function.

Function	Shift lever position	Door lock switch position
Shift position linked door locking function	“P”	🔒
Shift position linked door unlocking function		🔓
Speed linked door locking function	“N”	🔒
Driver’s door linked door unlocking function		🔓

When the setting or canceling operation is complete, all doors are locked and then unlocked.

1-2. Opening, closing and locking the doors

n **Impact detection door lock release system**

In the event that the vehicle is subject to a strong impact, all the doors are unlocked.

Depending on the force of the impact or the type of accident, however, the system may not operate.

n **Customization that can be configured at Toyota dealer or by the TFT type multi-information display**

Settings (e.g. unlocking function using a key) can be changed.
(Customizable features →P. 640)

1

Before driving

CAUTION

n **To prevent an accident**

Observe the following precautions while driving the vehicle.

Failing to do so may result in a door opening and an occupant falling out, resulting in death or serious injury.

! Always use a seat belt.

! Always lock all doors.

! Ensure that all doors are properly closed.

! Do not pull the inside handle of the doors while driving.

The doors may be opened and the passengers are thrown out of the vehicle and it may result in death or serious injury.

Be especially careful for the front doors, as the doors may be opened even if the inside lock buttons are in locked position.

! Set the rear door child-protector locks when children are seated in the rear seat.

1-2. Opening, closing and locking the doors

Back door

The back door can be opened using the back door opener. The back door can be locked and unlocked using the entry function (vehicles with smart key system), wireless remote control or door lock switch. In addition, the power back door (if equipped) can be opened using the power back door switch or wireless remote control.

n Unlocking and locking the back door

- ▶ Entry function (vehicles with smart key system)
→P. 28
- ▶ Wireless remote control
→P. 43
- ▶ Door lock switch
→P. 48

n Opening the back door from outside the vehicle

- ▶ Back door opener

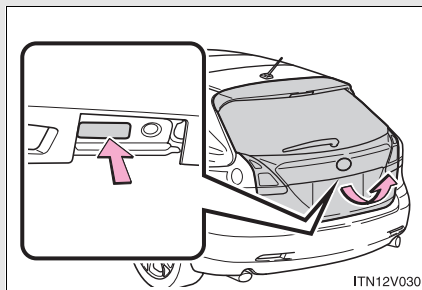

Raise the back door while pushing up the back door opener switch.

- ▶ Wireless remote control (vehicles with power back door)
→P. 43

1-2. Opening, closing and locking the doors

n Opening the back door from inside the vehicle (vehicles with power back door)

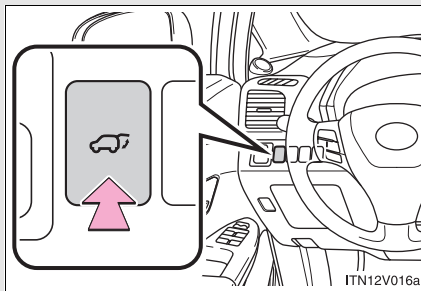

Push and hold the switch to open/close.

Pressing the switch again while the power back door is operating will cause the operation to reverse.

However, the reverse operation cannot be performed for the first second after pressing the switch to operate the door.

1

Before driving

Power back door switch (vehicles with power back door)

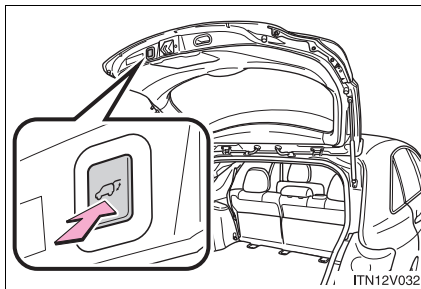

Push the switch to close.

Pressing the switch again while the power back door is closing will cause it to open again.

However, the reverse operation cannot be performed for the first second after pressing the switch to close the door.

The back door can be opened even if it is locked. Lock the back door again when you leave the vehicle. The back door will not lock automatically after it has been opened and then closed.

A buzzer sounds and the emergency flashers flash twice to indicate that the back door has been opened/closed.

1-2. Opening, closing and locking the doors

Canceling the power back door system (vehicles with power back door)

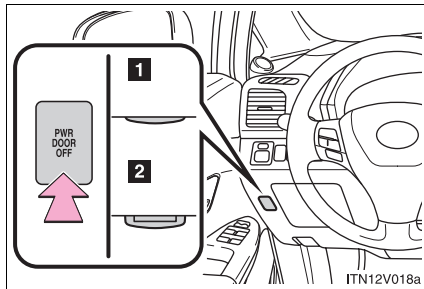

Turn the main switch to disable the power back door system.

1 Inoperative

2 Operative

The back door cannot be operated even with the wireless remote control or power back door switch.

A buzzer will sound twice if the power back door switch is pressed while the power back door system is inoperative.

■ When closing the back door

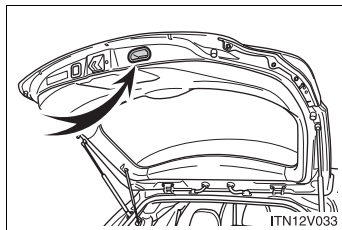

Lower the back door using the back door handle, and make sure to push the back door down from the outside to close it.

Be careful not to pull the back door sideways when closing the back door with the handle.

1-2. Opening, closing and locking the doors

n **The power back door can be opened/closed when**

▶ Vehicles with smart key system

- l The “ENGINE START STOP” switch is in IGNITION ON mode, and the shift lever is in “P”.
- l The “ENGINE START STOP” switch is in OFF or ACCESSORY mode.

▶ Vehicles without smart key system

- l The engine switch is in the “ON” position, and the shift lever is in “P”.
- l The engine switch is in the “LOCK” or “ACC” position.

n **Jam protection function (vehicles with power back door)**

If anything obstructs the power back door while it is closing/opening, the back door will automatically operate in the opposite direction.

n **If the power back door does not work**

The back door must be initialized. To initialize, close the back door completely by hand.

n **Back door closer**

In the event that the back door is left slightly open, the back door closer will automatically close it to the fully closed position.

1

Before driving

1-2. Opening, closing and locking the doors

CAUTION

n While driving

- I** Keep the back door closed while driving.
If the back door is left open, it may hit near-by objects while driving or luggage may be unexpectedly thrown out, causing an accident.
In addition, exhaust gases may enter the vehicle, causing death or a serious health hazard. Make sure to close the back door before driving.
- I** Before driving the vehicle, make sure that the back door is fully closed. If the back door is not fully closed, it may open unexpectedly while driving, causing an accident.
- I** Never let anyone sit in the luggage compartment. In the event of sudden braking or a collision, they are susceptible to death or serious injury.

n When children are in the vehicle

Observe the following precautions.

Failure to do so may result in death or serious injury.

- I** Do not leave children alone in the luggage compartment.
If a child is accidentally locked in the luggage compartment, they could have heat exhaustion.
- I** Do not allow a child to open or close the back door.
Doing so may cause the back door to operate unexpectedly, or cause the child's hands, head, or neck to be caught by the closing back door.

1-2. Opening, closing and locking the doors

CAUTION

n Operating the back door

Observe the following precautions.

Failure to do so may cause parts of the body to be caught, resulting in serious injury.

- I** Remove any heavy loads, such as snow and ice, from the back door before opening it. Failure to do so may cause the back door fall closed again after it is opened.
- I** When opening or closing the back door, thoroughly check to make sure the surrounding area is safe.
- I** If anyone is in the vicinity, make sure they are safe and let them know that the back door is about to open or close.
- I** Use caution when opening or closing the back door in windy weather as it may move abruptly in strong wind.

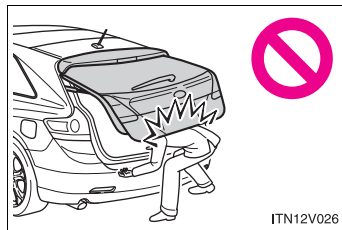

- I** The back door may fall if it is not opened fully. It is more difficult to open or close the back door on an incline than on a level surface, so beware of the back door unexpectedly opening or closing by itself. Make sure that the back door is fully open and secure before using the luggage compartment.

1

Before driving

1-2. Opening, closing and locking the doors

⚠ CAUTION

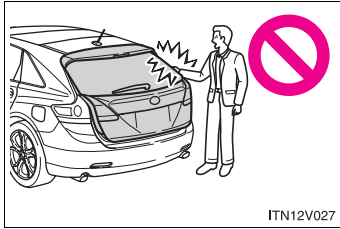

- I When closing the back door, take extra care to prevent your fingers etc. from being caught.
- I When closing the back door, make sure to press it lightly on its outer surface. If the back door handle is used to fully close the back door, it may result in hands or arms being caught.

- I Do not pull on the back door damper stay to close the back door, and do not hang on the back door damper stay. Doing so may cause hands to be caught or the back door damper stay to break, causing an accident.
- I Do not attach any accessories other than genuine Toyota parts to the back door. Such additional weight on the back door may cause the back door to fall closed again after it is opened.

n Back door closer

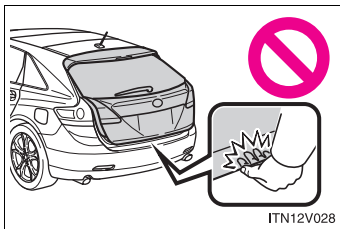

- I In the event that the back door is left slightly open, the back door closer will automatically close it to the fully closed position. It takes several seconds before the back door closer begins to operate. Be careful not to catch fingers or anything else in the back door, as this may cause bone fractures or other serious injuries.

- I For vehicles with power back door, use caution when using the back door closer as it still operates when the power back door system is cancelled.

1-2. Opening, closing and locking the doors

CAUTION**n Power back door (if equipped)**

Observe the following precautions when operating the power back door. Failure to do so may cause serious injury.

- I** Check the safety of the surrounding area to make sure there are no obstacles or anything that could cause any of your belongings to get caught.
- I** If anyone is in the vicinity, make sure they are safe and let them know that the back door is about to open or close.
- I** On an incline, the back door may fall after it opens automatically. Make sure the back door is fully open and secure.
- I** In the following situations, the power back door may detect an abnormality and automatic operation may be stopped. In this case, the back door has to be operated manually. Take extra care in this situation, as the stopped back door may suddenly fall, causing an accident.
 - When the back door contacts an obstacle
 - Vehicles with smart key system:
When the battery voltage suddenly drops, such as when the “ENGINE START STOP” switch is turned to IGNITION ON mode or the engine is started during automatic operation
 - Vehicles without smart key system:
When the battery voltage suddenly drops, such as when the engine switch is turned to the “ON” position or the engine is started during automatic operation
- I** Do not attach any accessories other than genuine Toyota parts to the back door. The power back door may not operate, causing itself to malfunction, or the back door may fall closed again after it is opened.
- I** In cases such as when replacing tires, make sure to turn off the power back door main switch. Failure to do so may cause the back door to operate unintentionally if the power back door switch is accidentally touched, resulting in hands and fingers being caught and injured.

1

Before driving

1-2. Opening, closing and locking the doors

CAUTION

n Jam protection function (vehicles with power back door)

Observe the following precautions.
Failure to do so may cause serious injury.

- I** Never use any part of your body to intentionally activate the jam protection function.
- I** The jam protection function may not work if something gets caught just before the back door fully closes. Be careful not to catch fingers or anything else.
- I** The jam protection function may not work depending on the shape of the object that is caught. Be careful not to catch fingers or anything else.

NOTICE

n Back door damper stays

The back door is equipped with damper stays that hold the back door in place.

Observe the following precautions.
Failure to do so may cause damage to the back door damper stay, resulting in malfunction.

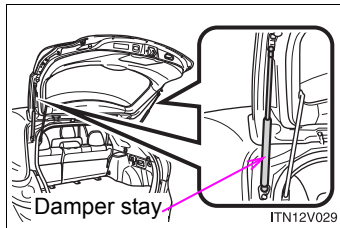

- I** Do not attach any foreign objects, such as stickers, plastic sheets, or adhesives to the damper stay rod.
- I** Do not touch the damper stay rod with gloves or other fabric items.
- I** Do not attach any accessories other than genuine Toyota parts to the back door.
- I** Do not place your hand on the damper stay or apply lateral forces to it.

1-2. Opening, closing and locking the doors

NOTICE

n To prevent back door closer malfunction

Do not apply excessive force to the back door while the back door closer is operating.

n To prevent damage to the power back door (vehicles with power back door)

I Make sure that there is no ice between the back door and frame that would prevent movement of the back door. Operating the power back door when excessive load is present on the back door may cause a malfunction.

I Do not apply excessive force to the back door while the power back door is operating.

I Take care not to damage the sensors (installed on the right and left edges of the power back door) with a knife or other sharp object. If the sensor is disconnected, the power back door will not operate in automatic operation.

1

Before driving

1-3. Adjustable components (seats, mirrors, steering wheel) Front seats

► Power seat

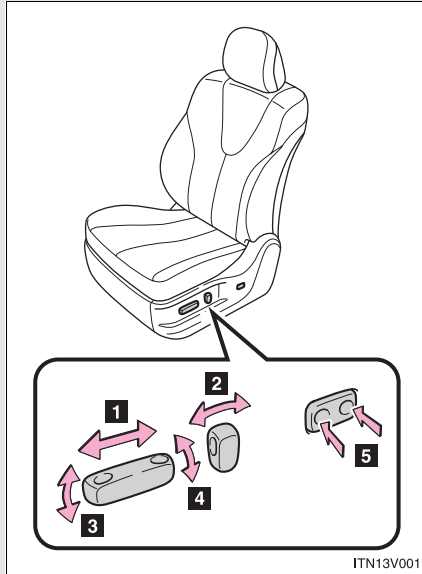

- 1** Seat position fore/aft control switch
- 2** Seatback angle control switch
- 3** Seat cushion (front) angle control switch (driver's side only)
- 4** Vertical height control switch (driver's side only)
- 5** Lumbar support control switch

► Manual seat

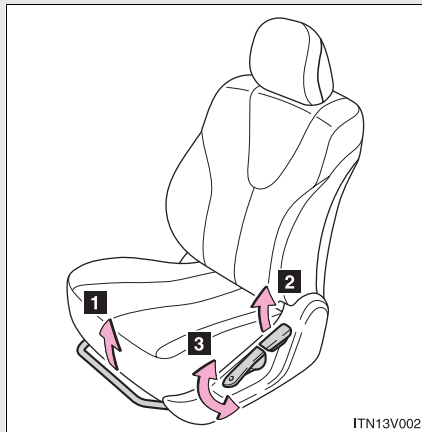

- 1** Seat position fore/aft adjustment lever
- 2** Seatback angle adjustment lever
- 3** Vertical height adjustment lever (driver's side only)

Pull up the lever until the lock is completely released.

1-3. Adjustable components (seats, mirrors, steering wheel)

Active head restraints

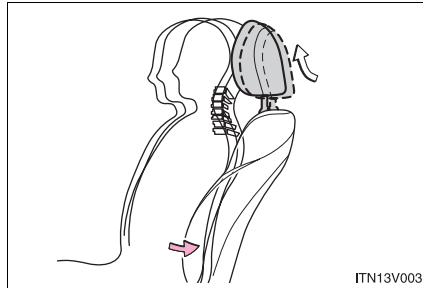

When the occupant's lower back presses against the seatback during a rear-end collision, the head restraint moves slightly forward and upward to help reduce the risk of whiplash on the seat occupant.

1

Before driving

n Active head restraints

Even small forces applied to the seatback may cause the head restraint to move. Pushing up a locked head restraint forcibly may make the inner structure of the head restraint appear. This does not indicate a problem.

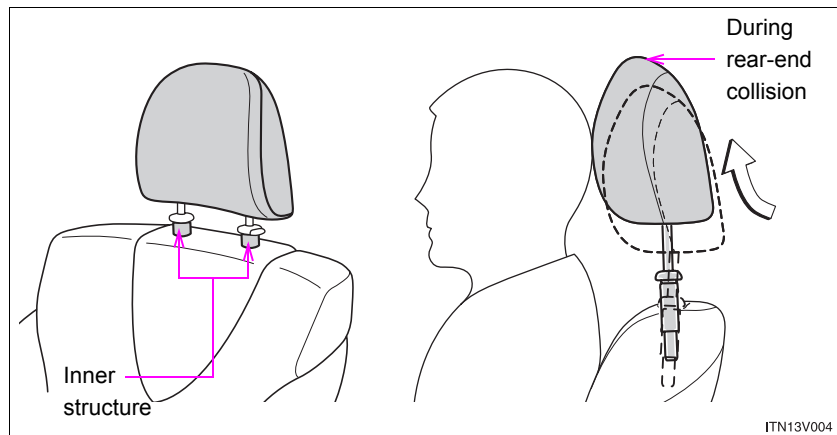

1-3. Adjustable components (seats, mirrors, steering wheel)

CAUTION

n Seat adjustment

- I** Be careful that the seat does not hit passengers or luggage.
- I** Do not recline the seat more than necessary when the vehicle is in motion to reduce the risk of sliding under the lap belt.
If the seat is too reclined, during an accident the lap belt may slide past the hips and apply restraint forces directly to the abdomen or your neck may contact the shoulder belt, increasing the risk of death or serious injury.
- I** Manual seat only: After adjusting the seat, make sure that the seat is locked in position.

1-3. Adjustable components (seats, mirrors, steering wheel)

Rear seats

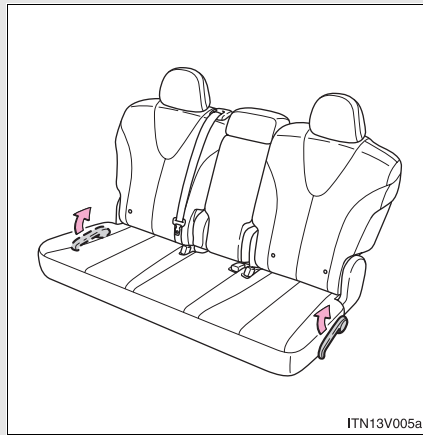

Seatback angle adjustment lever

Pull up the lever until the lock is completely released.

1

Before driving

Folding down the rear seatbacks

ⓘ Before folding down the rear seatbacks

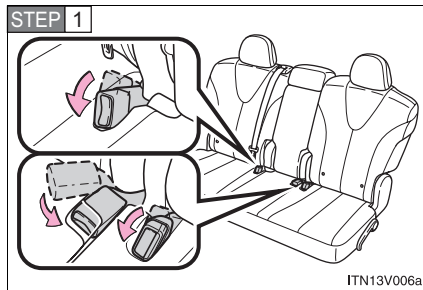

Stow the seat belt buckles and lower the head restraints to the lowest position.

1-3. Adjustable components (seats, mirrors, steering wheel)

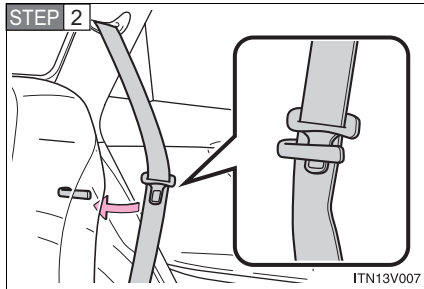

Pass the outer seat belts and plates through the seat belt hangers.

This prevents the shoulder belt from being damaged.

Make sure that the seat belts are removed from the hangers before using them.

n Folding down the rear seatbacks

► From inside

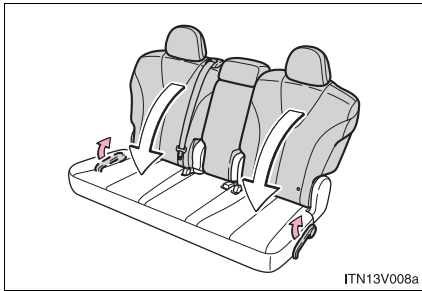

Fold down the seatback while pulling the seatback angle adjustment lever.

Pull up the lever until the lock is completely released.

► From outside

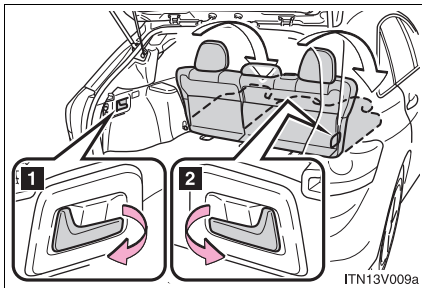

Pull the lever.

1 For left side rear seatback

2 For right side and center rear seatback

1-3. Adjustable components (seats, mirrors, steering wheel)

⚠ CAUTION**n Seat adjustment**

Do not recline the seat more than necessary when the vehicle is in motion, to reduce the risk of sliding under the lap belt. If the seat is too reclined, the lap belt may slide past the hips and apply restraint forces directly to the abdomen or your neck may contact the shoulder belt, increasing the risk of death or serious injury in the event of an accident.

n Before folding down a rear seat

Do not fold down a rear seat when there are passengers sitting in the rear seats or when there is luggage placed on the rear seats.

n When returning the seatbacks to their original position

Observe the following precautions. Failure to do so may result in death or serious injury.

- ! Be careful not to get your hands pinched in the seat.
- ! Make sure the seatbacks are securely locked by lightly rocking it back and forth.
- ! Check that the seat belts are not twisted or caught under the seat.
- ! Arrange the seat belts in the proper positions for ready use.

1

Before driving

⚠ NOTICE**n When folding down the rear seatbacks**

The seat belts and buckles must be stowed.

1-3. Adjustable components (seats, mirrors, steering wheel) Head restraints

Head restraints are provided for all seats.

► Front and rear outboard seats

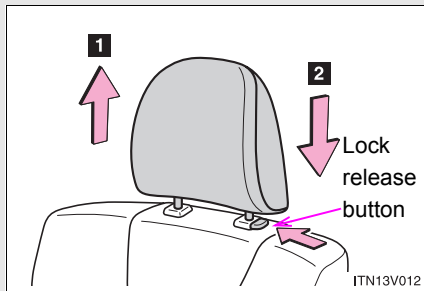

Vertical adjustment

1 Up

Pull the head restraint up.

2 Down

Push the head restraints down while pressing the lock release button.

► Rear center seat

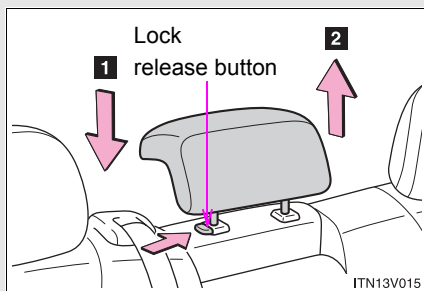

Vertical adjustment

1 Down

2 Up

Push the head restraint up or down while pressing the lock release button.

n Adjusting the height of the head restraints

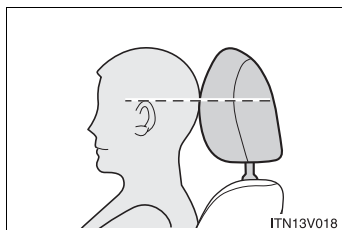

Make sure that the head restraints are adjusted so that the center of the head restraint is closest to the top of your ears.

1-3. Adjustable components (seats, mirrors, steering wheel)

n **Adjusting the rear center seat head restraint**

Always raise the head restraint one level from the stowed position when using.

n **Removing the head restraints**

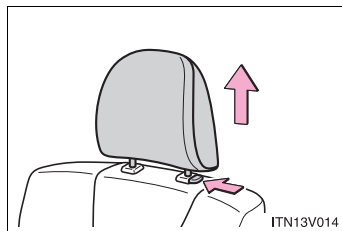

Pull the head restraint up while pressing the lock release button.

n **Installing the head restraints**

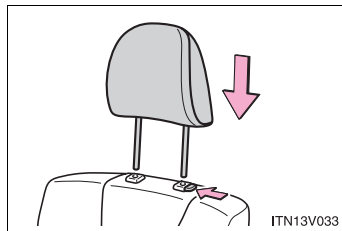

Align the head restraint with the installation holes and push it down to the lock position.

Press and hold the lock release button when lowering the head restraint.

1

Before driving

CAUTION

n **Head restraint precautions**

Observe the following precautions regarding the head restraints. Failure to do so may result in death or serious injury.

- ! Use the head restraints designed for each respective seat.
- ! Adjust the head restraints to the correct position at all times.
- ! After adjusting the head restraints, push down on them and make sure they are locked in position.
- ! Do not drive with the head restraints removed.

1-3. Adjustable components (seats, mirrors, steering wheel)

Seat belts

Make sure that all occupants are wearing their seat belts before driving the vehicle.

n Correct use of the seat belts

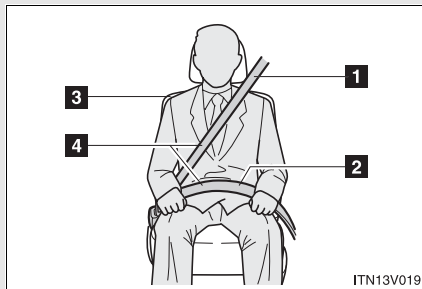

1 Extend the shoulder belt so that it comes fully over the shoulder, but does not come into contact with the neck or slide off the shoulder.

2 Position the lap belt as low as possible over the hips.

3 Adjust the position of the seatback. Sit up straight and well back in the seat.

4 Do not twist the seat belt.

n Fastening and releasing the seat belt

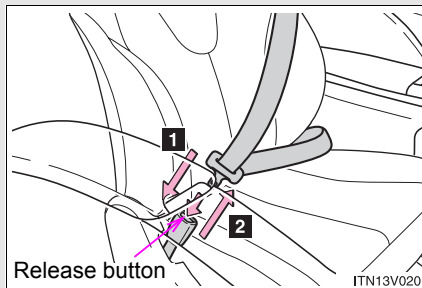

1 Fastening the belt

Push the tab into the buckle until a clicking sound is heard.

2 Releasing the belt

Press the release button.

1-3. Adjustable components (seats, mirrors, steering wheel)

n Adjusting the height of the belt (front seats)

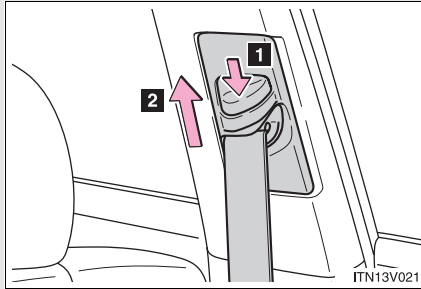

1 Down

2 Up

Move the height adjuster up and down as needed until you hear a click.

1

Before driving

Seat belt pretensioners (front seats)

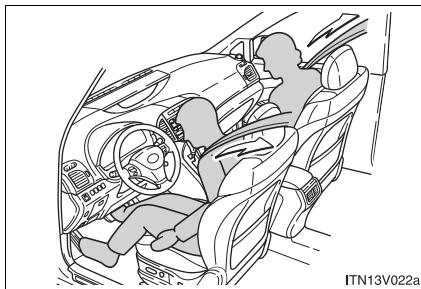

The pretensioner helps the seat belt to quickly restrain the occupant by retracting the seat belt when the vehicle is subjected to certain types of severe frontal collision.

The pretensioner may not activate in the event of a minor frontal impact, a side impact or a rear impact.

1-3. Adjustable components (seats, mirrors, steering wheel)

n **Emergency locking retractor (ELR)**

The retractor will lock the belt during a sudden stop or on impact. It may also lock if you lean forward too quickly. A slow, easy motion will allow the belt to extend, and you can move around fully.

n **Automatic locking retractor (ALR)**

When a passenger's shoulder belt is completely extended and then retracted even slightly, the belt is locked in that position and cannot be extended. This feature is used to hold the child restraint system (CRS) firmly. To free the belt again, fully retract the belt and then pull the belt out once more. (→P. 133)

n **Pregnant women**

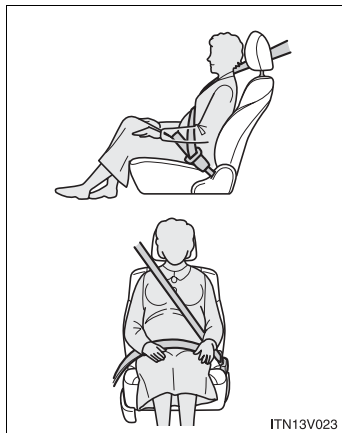

Obtain medical advice and wear the seat belt in the proper way. (→P. 72)

Women who are pregnant should position the lap belt as low as possible over the hips in the same manner as other occupants. Extend the shoulder belt completely over the shoulder and position the belt across the chest. Avoid belt contact over the rounding of the abdominal area.

If the seat belt is not worn properly, not only a pregnant woman, but also the fetus could suffer death or serious injury as a result of sudden braking or a collision.

n **People suffering illness**

Obtain medical advice and wear the seat belt in the proper way. (→P. 72)

1-3. Adjustable components (seats, mirrors, steering wheel)

n When not using the rear outboard seat belts

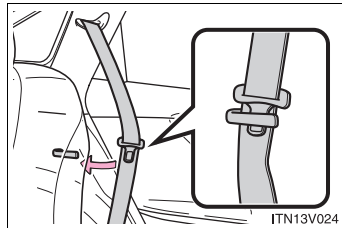

Pass the outer seat belts and plates through the seat belt hangers to prevent the shoulder belts from being damaged.

1

Before driving

n Child seat belt usage

The seat belts of your vehicle were principally designed for persons of adult size.

- l Use a child restraint system appropriately for the child, until the child becomes large enough to properly wear the vehicle's seat belt. (→P. 127)
- l When the child becomes large enough to properly wear the vehicle's seat belt, follow the instructions on P. 72 regarding seat belt usage.

n Replacing the belt after the pretensioner has been activated

If the vehicle is involved in multiple collisions, the pretensioner will activate for the first collision, but will not activate for the second or subsequent collisions.

n Seat belt extender

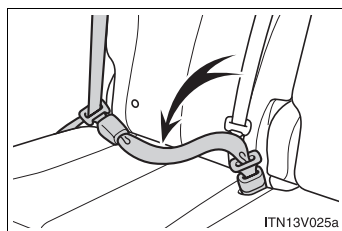

If your seat belts cannot be fastened securely because they are not long enough, a personalized seat belt extender is available from your Toyota dealer free of charge.

1-3. Adjustable components (seats, mirrors, steering wheel)

 **CAUTION**

Observe the following precautions to reduce the risk of injury in the event of sudden braking, sudden swerving or an accident. Failing to do so may cause death or serious injury.

n Wearing a seat belt

- | Ensure that all passengers wear a seat belt.
- | Always wear a seat belt properly.
- | Each seat belt should be used by one person only. Do not use a seat belt for more than one person at the same time, including children.
- | Toyota recommends that children should be seated in the rear seat and always use a seat belt and/or an appropriate child restraint system.
- | Do not recline the seat any more than necessary to achieve a proper seating position. The seat belt is most effective when the occupants are sitting up straight and well back in the seats.
- | Do not wear the shoulder belt under your arm.
- | Always wear your seat belt low and snug across your hips.

n Adjustable shoulder anchor

Always make sure the shoulder belt is positioned across the center of your shoulder. The belt should be kept away from your neck, but not falling off your shoulder. Failure to do so could reduce the amount of protection in an accident and cause death or serious injuries in the event of a sudden stop, sudden swerve or an accident. (→P. 73)

n Seat belt pretensioners

- | Do not place anything, such as a cushion, on the front passenger's seat. Doing so will disperse the passenger's weight, which prevents the sensor from detecting the passenger's weight properly. As a result, the seat belt pretensioner for the front passenger's seat may not activate in the event of a collision.
- | If the pretensioner has activated, the SRS warning light will come on. In that case, the seat belt cannot be used again and must be replaced at your Toyota dealer.

1-3. Adjustable components (seats, mirrors, steering wheel)

CAUTION

n Child restraint lock function belt precaution

Do not allow children to play with the child restraint lock function belt. If the belt becomes twisted around a child's neck, it will not be possible to pull the belt out leading to choking or other serious injuries that could result in death.

If this occurs and the buckle cannot be unfastened, scissors should be used to cut the belt.

n Seat belt damage and wear

I Do not damage the seat belts by allowing the belt, plate or buckle to be jammed in the door.

I Inspect the seat belt system periodically. Check for cuts, fraying, and loose parts. Do not use a damaged seat belt until it is replaced. Damaged seat belts cannot protect an occupant from death or serious injury.

I Ensure that the belt and tab are locked and the belt is not twisted. If the seat belt does not function correctly, immediately contact your Toyota dealer.

I Replace the seat assembly, including the belts, if your vehicle has been involved in a serious accident, even if there is no obvious damage.

I Do not attempt to install, remove, modify, disassemble or dispose of a seat belt. Have any necessary repairs carried out by your Toyota dealer. Inappropriate handling of the pretensioner may cause it to activate or operate improperly and may cause death or serious injury.

1

Before driving

1-3. Adjustable components (seats, mirrors, steering wheel)

CAUTION

n Using a seat belt extender

- I** Do not wear the seat belt extender, if you can fasten the seat belt without the extender.
- I** Do not use the seat belt extender when installing a child restraint system, because the belt will not securely hold the child restraint system, increasing the risk of death or serious injury in the event of a sudden stop, sudden swerve or an accident.
- I** The personalized extender may not be safe on another vehicle, when used by another person, or at a different seating position other than the one originally intended.

NOTICE

n When using a seat belt extender

When releasing the seat belt, press on the buckle release button on the extender, not on the seat belt.
This helps prevent damage to the vehicle interior and the extender itself.

1-3. Adjustable components (seats, mirrors, steering wheel) Steering wheel

The steering wheel can be adjusted to a comfortable position.

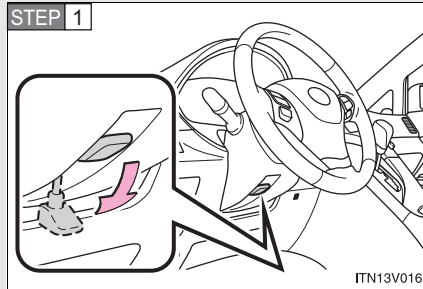

Hold the steering wheel and press the lever down.

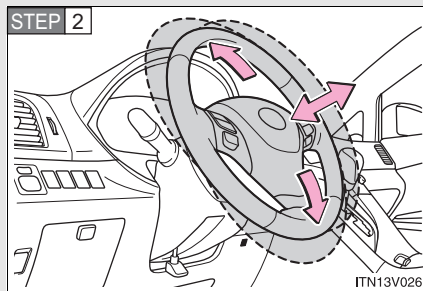

Adjust to the ideal position by moving the steering wheel horizontally and vertically.

After adjustment, pull the lever up to secure the steering wheel.

1

Before driving

⚠ CAUTION

n While driving

Do not adjust the steering wheel. Doing so may cause the driver to mishandle the vehicle and an accident, resulting in death or serious injury.

n After adjusting the steering wheel

Make sure that the steering wheel is securely locked. Otherwise, the steering wheel may move suddenly, possibly causing an accident and resulting in death or serious injury.

1-3. Adjustable components (seats, mirrors, steering wheel) Inside rear view mirror

Glare from the headlights of vehicles behind can be reduced by using the following functions.

► **Auto anti-glare inside rear view mirror**

In auto mode, sensors are used to detect the headlights of vehicles behind and automatically reduce the reflected light.

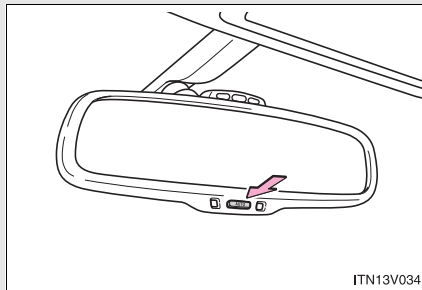

Turns auto mode on/off.

The indicator comes on when auto mode is turned on.

Vehicles with smart key system:

The mirror will revert to the automatic mode each time the "ENGINE START STOP" switch is turned to IGNITION ON mode.

Vehicles without smart key system:

The mirror will revert to the automatic mode each time the engine switch is turned to the "ON" position.

► **Manual anti-glare inside rear view mirror**

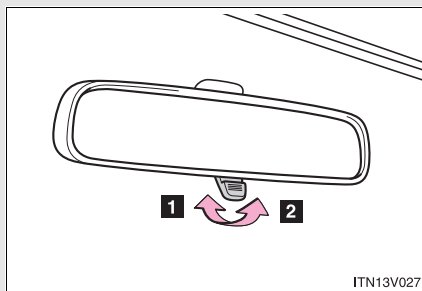

1 Normal position

2 Anti-glare position

1-3. Adjustable components (seats, mirrors, steering wheel)

Adjusting the height of rear view mirror

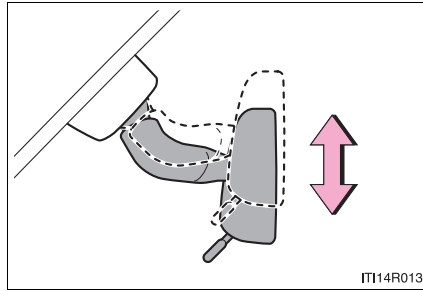

Adjust the height of the rear view mirror by moving it up and down.

1

Before driving

n To prevent sensor error (vehicles with auto anti-glare inside rear view mirror)

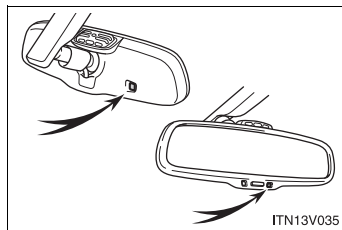

To ensure correct functioning of the sensors, do not touch or cover the sensors.

⚠ CAUTION

n While driving

Do not adjust the position of the mirror. Doing so may lead to mishandling of the vehicle and an accident, or resulting in death or serious injury.

1-3. Adjustable components (seats, mirrors, steering wheel) Outside rear view mirrors

Mirror angle can be adjusted using the switch.

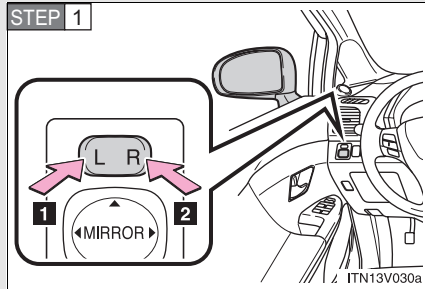

Select a mirror to adjust.

- 1 Left
- 2 Right

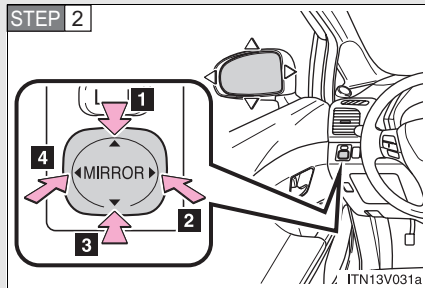

Adjust the mirror.

- 1 Up
- 2 Right
- 3 Down
- 4 Left

Folding back the mirrors

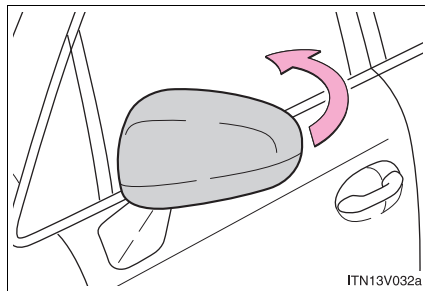

Push backward to fold the mirrors.

1-3. Adjustable components (seats, mirrors, steering wheel)

n **Mirror angle can be adjusted when**

- ▶ Vehicles with smart key system

The "ENGINE START STOP" switch is in ACCESSORY or IGNITION ON mode.

- ▶ Vehicles without smart key system

The engine switch is in the "ACC" or "ON" position.

n **When the mirrors are fogged up (vehicles with outside rear view mirror defoggers)**

Turn on the rear window defogger to defog the mirrors. (→P. 278)

1

Before driving

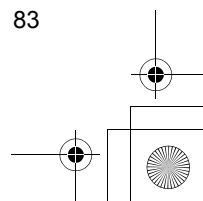
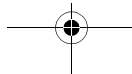
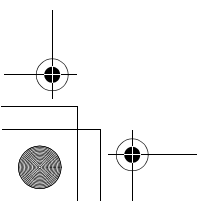
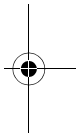
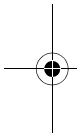

1-3. Adjustable components (seats, mirrors, steering wheel)

CAUTION

n While driving

Observe the following precautions.

Failing to do so may result in losing control of the vehicle and cause an accident, resulting in death or serious injury.

I Do not adjust the mirrors.

I Do not drive with the mirrors folded back.

I Before driving, be sure to extend mirrors and make an adjustment properly.

n When the mirror defoggers are operating (vehicles with outside rear view mirror defoggers)

Do not touch the rear view mirror surfaces, as they can become very hot and burn you.

NOTICE

n If ice should jam the mirror

Do not operate the control or scrape the mirror face. Use a spray de-icer to free the mirror.

1-4. Opening and closing the windows and moon roof Power windows

The power windows can be opened and closed using the following switches.

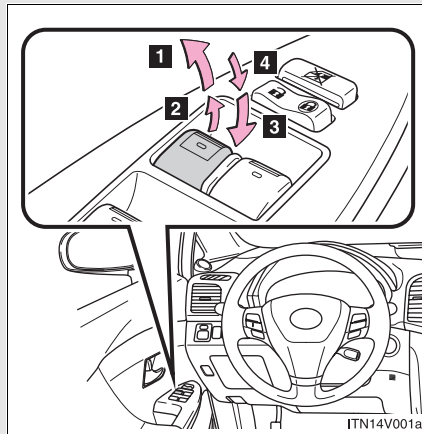

- 1** One-touch closing*
- 2** Closing
- 3** One-touch opening*
- 4** Opening

*:Pressing the switch in the opposite direction will stop window travel partway.

1

Before driving

Lock switch

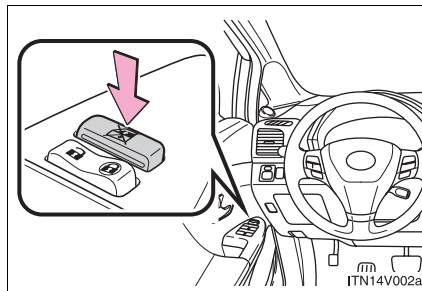

Press the switch down to lock passenger window switches.

Use this switch to prevent children from accidentally opening or closing a passenger window.

1-4. Opening and closing the windows and moon roof

n **The power windows can be operated when**

▶ Vehicles with smart key system

The "ENGINE START STOP" switch is in IGNITION ON mode.

▶ Vehicles without smart key system

The engine switch is in the "ON" position.

n **Operating the power windows after turning the engine off**

▶ Vehicles with smart key system

The power windows can be operated for approximately 45 seconds even after the "ENGINE START STOP" switch is turned to ACCESSORY mode or turned off. They cannot, however, be operated once either front door is opened.

▶ Vehicles without smart key system

The power windows can be operated for approximately 45 seconds even after the engine switch is turned to the "ACC" or "LOCK" position. They cannot, however, be operated once either front door is opened.

n **Jam protection function**

If an object becomes caught between the window and the window frame, window travel is stopped and the window is opened slightly.

1-4. Opening and closing the windows and moon roof

n When the power window does not close normally

If the jam protection function is operating abnormally and a window cannot be closed, perform the following operations using the power window switch on the relevant door.

- 1 After stopping the vehicle, the window can be closed by holding the power window switch in the one-touch closing position while the "ENGINE START STOP" switch is turned to IGNITION ON mode (vehicles with smart key system) or the engine switch is turned to the "ON" position (vehicles without smart key system).

- 1 If the window still cannot be closed even by carrying out the operation explained above, initialize the function by performing the following procedure.

STEP 1 Hold the power window switch in the one-touch closing position. Continue holding the switch for a further 6 seconds after the window has closed.

STEP 2 Hold the power window switch in the one-touch opening position. Continue holding the switch for a further 2 seconds after the window has opened completely.

STEP 3 Hold the power window switch in the one-touch closing position once again. Continue holding the switch for a further 2 seconds after the window has closed.

If you release the switch while the window is moving, start again from the beginning. If the window continues to close but then re-open slightly even after performing the above procedure correctly, have the vehicle inspected by your Toyota dealer.

1

Before driving

1-4. Opening and closing the windows and moon roof

CAUTION

n Closing the windows

Observe the following precautions.

Failing to do so may result in death or serious injury.

- I** Check to make sure that all passengers do not have any part of their body in a position where it could be caught when a window is being operated.
- I** Do not allow children to operate the power windows.
Closing a power window on someone can cause death or serious injury.

n Jam protection function

- I** Never try jamming any part of your body to activate the jam protection function intentionally.
- I** The jam protection function may not work if something gets caught just before the window fully closes.

1-4. Opening and closing the windows and moon roof Moon roof*

Use the overhead switches to open, close, and tilt the moon roof up and down.

□ Opening and closing

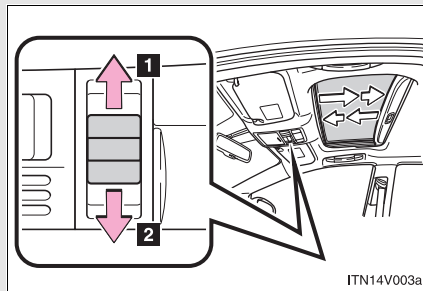

1 Open

The moon roof stops slightly before the fully open position to reduce wind noise. Move the switch backward again to fully open.

2 Close (push and hold)

The moon roof stops once. Push and hold the switch again to fully close.

□ Tilt up and down

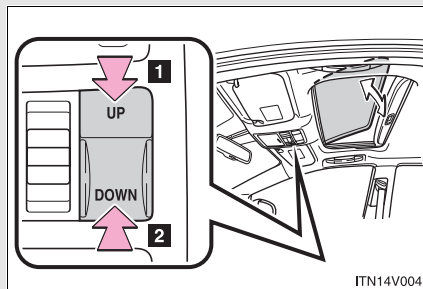

1 Tilt up

2 Tilt down (push and hold)

1

Before driving

*: If equipped

1-4. Opening and closing the windows and moon roof

n **The moon roof can be operated when**

▶ Vehicles with smart key system

The “ENGINE START STOP” switch is in IGNITION ON mode.

▶ Vehicles without smart key system

The engine switch is in the “ON” position.

n **Operating the moon roof after turning the engine off**

▶ Vehicles with smart key system

The moon roof can be operated for approximately 45 seconds even after the “ENGINE START STOP” switch is turned to ACCESSORY mode or turned off. It cannot, however, be operated once either front door is opened.

▶ Vehicles without smart key system

The moon roof can be operated for approximately 45 seconds even after the engine switch is turned to the “ACC” or “LOCK” position. It cannot, however, be operated once either front door is opened.

n **To reduce moon roof wind noise**

Drive with the moon roof opened to slightly before the fully open position as driving with the moon roof opened fully will cause wind noise.

n **Sunshade**

→P. 92

n **Open moon roof warning buzzer**

▶ Vehicles with smart key system

The buzzer sounds and message is shown on the multi-information display (TFT type only) when the “ENGINE START STOP” switch is turned off and the driver’s door is opened with the moon roof open.

▶ Vehicles without smart key system

The buzzer sounds and message is shown on the multi-information display (TFT type only) when the engine switch is turned to the “LOCK” position and the driver’s door is opened with the moon roof open.

1-4. Opening and closing the windows and moon roof

n When the moon roof does not close normally

Perform the following procedure:

STEP 1 Stop the vehicle.

STEP 2 Open the moon roof halfway.

STEP 3 Press and hold the open/close switch in the close position. When the moon roof reaches the full close position, maintain the open/close switch in the close position for more than 2 seconds. It will adjust slightly and then stop.

STEP 4 To ensure the initialization is complete, make sure opening, closing, tilting up and down functions work properly.

If the moon roof does not fully close even after performing the above procedure correctly, have the vehicle inspected by your Toyota dealer.

1

Before driving

⚠ CAUTION

n Opening the moon roof

Observe the following precautions.

Failing to do so may cause death or serious injury.

- ! Do not allow any passengers to put their hands or heads outside the vehicle while it is moving.
- ! Do not sit on top of the moon roof.

n Closing the moon roof

Observe the following precautions.

Failing to do so may result in death or serious injury.

- ! Check to make sure that all passengers do not have any part of their bodies in a position where they could be caught when the moon roof is being operated.
- ! Do not allow children to operate the moon roof. Closing the moon roof on someone can cause death or serious injury.

1-4. Opening and closing the windows and moon roof Sunshade*

The sunshade can be opened and closed manually.

► Front

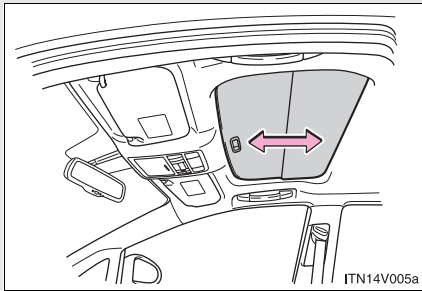

Slide the sunshade.

The front sunshade will open automatically when the moon roof is opened. (→P. 89)

► Rear

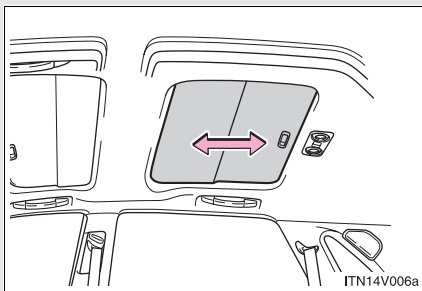

Slide the sunshade.

*: If equipped

1-5. Refueling

Opening the fuel tank cap

Perform the following steps to open the fuel tank cap.

1 **Before refueling the vehicle**

- ▶ Vehicles with smart key system
Turn the “ENGINE START STOP” switch off and ensure that all the doors and windows are closed.
- ▶ Vehicles without smart key system
Turn the engine switch to the “LOCK” position and ensure that all the doors and windows are closed.

2 **Opening the fuel tank cap**

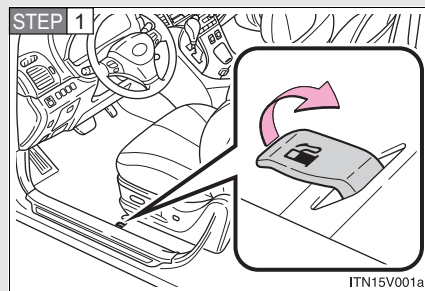

Pull the lever.

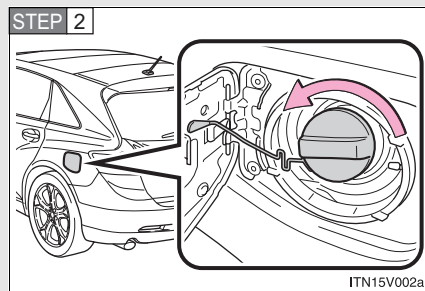

Turn the fuel tank cap slowly to open.

1

Before driving

1-5. Refueling

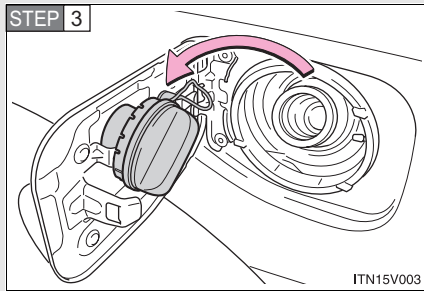

Hang the fuel tank cap on the back of the fuel filler door.

Closing the fuel tank cap

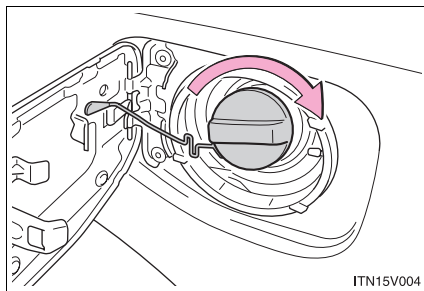

When replacing the fuel tank cap, turn it until a clicking sound is heard.

After releasing your hand, the cap will turn slightly to the opposite direction.

n Fuel types

Use unleaded gasoline. (Octane Rating 87 [Research Octane Number 91] or higher)

n Fuel tank capacity

Approximately 17.7 gal. (67 L, 14.7 Imp. gal.)

⚠ CAUTION**n Refueling the vehicle**

Observe the following precautions while refueling the vehicle. Failure to do so, may result in death or serious injury.

- I** Touch the vehicle or some other metal surface to discharge any static electricity.
Sparks resulting from discharging static electricity may cause the fuel vapors to ignite.
- I** Always hold the grips on the fuel tank cap and turn it slowly to remove it. A whooshing sound may be heard when the fuel tank cap is loosened. Wait until the sound cannot be heard before fully removing the cap. In hot weather, pressurized fuel may spray out the filler neck and cause injury.
- I** Do not allow anyone that has not discharged static electricity from their bodies to come close to an open fuel tank.
- I** Do not inhale vaporized fuel.
Fuel contains substances that are harmful if inhaled.
- I** Do not smoke while refueling the vehicle.
Doing so may cause the fuel to ignite and cause a fire.
- I** Do not return to the vehicle or touch any person or object that is statically charged.
This may cause static electricity to build up, resulting in a possible ignition hazard.

n When replacing the fuel tank cap

Do not use anything but a genuine Toyota fuel tank cap designed for your vehicle. Doing so may cause a fire or other incident which may result in death or serious injury.

1

Before driving

1-5. Refueling

NOTICE

n Refueling

Do not spill fuel during refueling.

Doing so may damage the vehicle, such as causing the exhaust systems to operate abnormally or damaging fuel system components or the vehicle's painted surface.

1-6. Theft deterrent system Engine immobilizer system

The vehicle's keys have built-in transponder chips that prevent the engine from starting if the key has not been previously registered in the vehicle's on-board computer.

Never leave the keys inside the vehicle when you leave the vehicle.

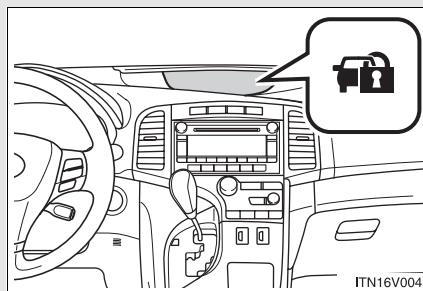

Vehicles with smart key system:

The indicator light flashes after the "ENGINE START STOP" switch has been turned off to indicate that the system is operating.

The indicator light stops flashing after the "ENGINE START STOP" switch has been turned to ACCESSORY or IGNITION ON mode to indicate that the system has been canceled.

Vehicles without smart key system:

The indicator light flashes after the key has been removed from the engine switch to indicate that the system is operating.

The indicator light stops flashing after the registered key has been inserted into the engine switch to indicate that the system has been canceled.

1

Before driving

1-6. Theft deterrent system

n **System maintenance**

The vehicle has a maintenance-free type engine immobilizer system.

n **Conditions that may cause the system to malfunction**

- l If the key is in contact with a metallic object.
- l If the key is in close proximity to or touching a key to the security system (key with a built-in transponder chip) of another vehicle.

n **Certifications for the engine immobilizer system**

- l For vehicles sold in the U.S.A.
 - ▶ Vehicles with smart key system
FCC ID: NI4TMIMB-1
 - ▶ Vehicles without smart key system
FCC ID: MOZRI-21BTY

NOTE:

This device complies with Part 15 of the FCC Rules. Operation is subject to the following two conditions: (1) this device may not cause harmful interference, and (2) this device must accept any interference received, including interference that may cause undesired operation.

FCC WARNING:

Changes or modifications not expressly approved by the party responsible for compliance could void the user's authority to operate the equipment.

1-6. Theft deterrent system

1 For vehicles sold in Canada

Operation is subject to the following two conditions: (1) this device may not cause interference, and (2) this device must accept any interference, including interference that may cause undesired operation of the device.

NOTICE

n To ensure the system operates correctly

Do not modify or remove the system. If modified or removed, the proper operation of the system cannot be guaranteed.

1

Before driving

1-6. Theft deterrent system Alarm*

The system sounds the alarm and flashes lights when forcible entry is detected.

n Triggering of the alarm

The alarm is triggered in the following situations when the alarm is set.

- l A locked door is unlocked or opened in any way other than by using the entry function (vehicles with smart key system), the wireless remote control door lock function or the mechanical key. (The doors will lock again automatically.)
- l The hood is opened.
- l The battery is reconnected.
- l The side windows are tapped or broken.

n Setting the alarm system

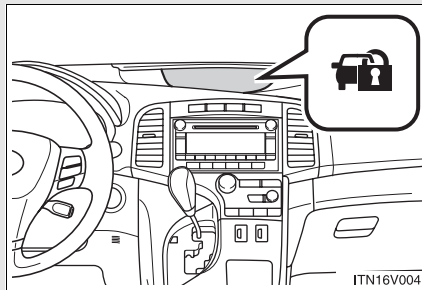

Close the doors and hood, and lock all doors using the entry function (vehicles with smart key system) or the wireless remote control. The system will be set automatically after 30 seconds.

The indicator light changes from being on to flashing when the system is set.

*: If equipped

1-6. Theft deterrent system

n **Deactivating or stopping the alarm**

Do one of the following to deactivate or stop the alarm.

- 1 Unlock the doors using the entry function (vehicles with smart key system) or the wireless remote control.
- 1 Start the engine. (The alarm will be deactivated or stopped after a few seconds.)

1

Before driving

n **System maintenance**

The vehicle has a maintenance-free type alarm system.

n **Items to check before locking the vehicle**

To prevent unexpected triggering of the alarm and vehicle theft, make sure of the following.

- 1 Nobody is in the vehicle.
- 1 The windows and moon roof are closed before the alarm is set.
- 1 No valuables or other personal items are left in the vehicle.

1-6. Theft deterrent system

n Triggering of the alarm

The alarm may be triggered in the following situations.
(Stopping the alarm deactivates the alarm system.)

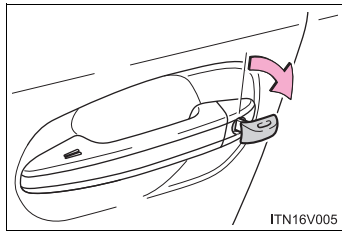

! The doors are unlocked using the mechanical key.

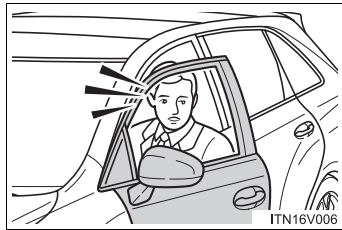

! A person inside the vehicle opens a door or hood.

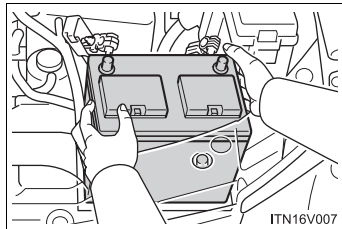



! The battery is recharged or replaced when the vehicle is locked.

1-6. Theft deterrent system

n **Panic mode**

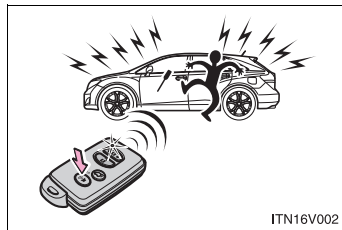
▶ Vehicles with smart key system



When  is pressed for longer than about one second, an alarm will sound for about 60 seconds and the vehicle lights will flash or come on to deter any person from trying to break into or damage your vehicle.

To stop the alarm, press any button on the wireless remote control.

1

Before driving

▶ Vehicles without smart key system

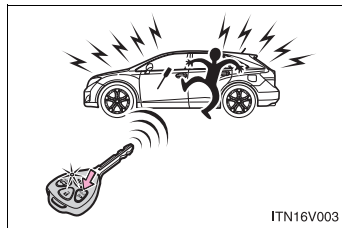

n **Customization that can be configured at Toyota dealer**

Settings (e.g. time elapsed before the alarm is set) can be changed.
(Customizable features →P. 640)

NOTICE

n **To ensure the system operates correctly**

Do not modify or remove the system. If modified or removed, the proper operation of the system cannot be guaranteed.

1-6. Theft deterrent system Theft prevention labels (U.S.A.)

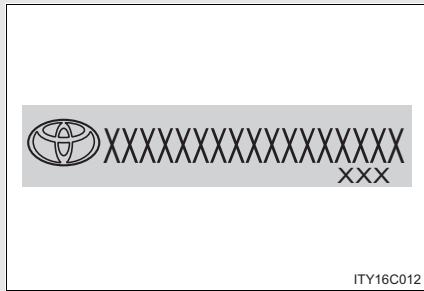

These labels are attached to the vehicle to reduce vehicle theft by facilitating the tracing and recovery of parts from stolen vehicles. Do not remove under penalty of law.

1-7. Safety information

Correct driving posture

Drive with a good posture as follows:

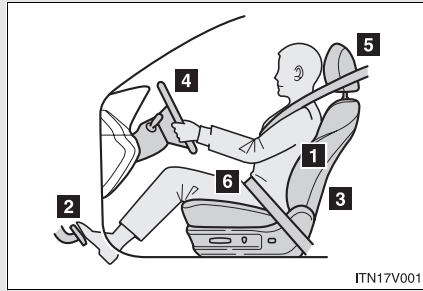

- 1** Sit upright and well back in the seat.
- 2** Adjust the position of the seat forward or backward to ensure the pedals can be reached and easily depressed to the extent required. (→P. 64)
- 3** Adjust the seatback so that the controls are easily operable.
- 4** Adjust the tilt and telescopic positions of the steering wheel downward so the air-bag is facing your chest. (→P. 79)
- 5** Lock the head restraint in place with the center of the head restraint closest to the top of your ears. (→P. 70)
- 6** Wear the seat belt correctly. (→P. 72)

1

Before driving

1-7. Safety information

CAUTION

n While driving

- I** Do not adjust the position of the driver's seat.
Doing so could cause the driver to lose control of the vehicle.
- I** Do not place a cushion between the driver or passenger and the seatback.
A cushion may prevent correct posture from being achieved, and reduce the effectiveness of the seat belt and head restraint, increasing the risk of death or serious injury to the driver or passenger.
- I** Do not place anything under the front seats.
Objects placed under the front seats may become jammed in the seat tracks and stop the seat from locking in place. This may lead to an accident. The adjustment mechanism may also be damaged.

n Adjusting the seat position

- I** Do not recline the seat more than necessary when the vehicle is in motion, to reduce the risk of sliding under the lap belt.
If the seat is too reclined during an accident, the lap belt may slide past the hips and apply restraint forces directly to the abdomen or your neck may contact the shoulder belt, increasing the risk of death or serious injury.
- I** Take care when adjusting the seat position to ensure that other passengers are not injured by the moving seat.
- I** Do not put your hands under the seat or near the moving parts to avoid injury.
Fingers or hands may become jammed in the seat mechanism.

1-7. Safety information

SRS airbags

The SRS airbags inflate when the vehicle is subjected to certain types of severe impacts that may cause significant injury to the occupants. They work together with the seat belts to help reduce the risk of death or serious injury.

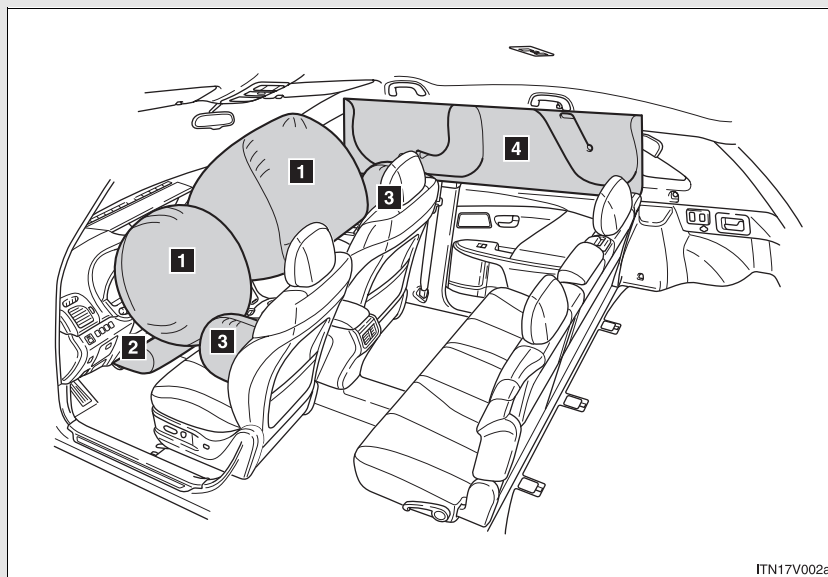

► Front airbags

1 Driver airbag/front passenger airbag

Can help protect the head and chest of the driver and front passenger from impact with interior components.

2 Knee airbag

Can help provide driver protection.

1

Before driving

1-7. Safety information

- ▶ Side and curtain shield airbags
- ▶ **3** Side airbags
Can help protect the torso of the front seat occupants.
- ▶ **4** Curtain shield airbags
Can help protect primarily the head of front and rear outboard seat occupants.

Airbag system components

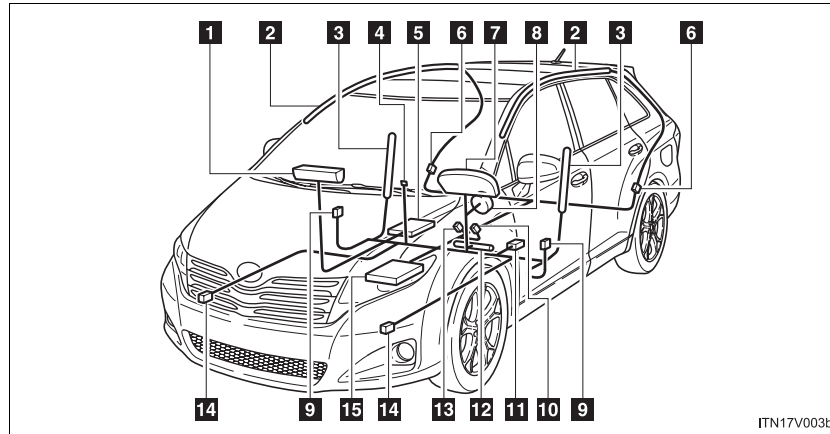

- | | |
|---|---|
| 1 Front passenger airbag | 9 Side and curtain shield airbag sensor |
| 2 Curtain shield airbag | 10 Driver's seat belt buckle switch |
| 3 Side airbag | 11 Driver's seat position sensor |
| 4 "AIR BAG ON/OFF" indicator light | 12 Knee airbag |
| 5 Occupant detection sensor | 13 Front passenger's seat belt buckle switch |
| 6 Curtain shield airbag sensor | 14 Front airbag sensor |
| 7 SRS warning light | 15 Airbag sensor assembly |
| 8 Driver airbag | |

1

Before driving

1-7. Safety information

Your vehicle is equipped with “ADVANCED AIRBAGS” designed based on US motor vehicle safety standards (FMVSS208). The airbag system controls airbag deployment power for the driver and front passenger. The driver airbag system consists of the driver seat’s position sensor etc. The front passenger’s airbag system consists of the front passenger occupant classification sensor etc.

The main SRS airbag system components are shown above. The SRS airbag system is controlled by the airbag sensor assembly. The airbag sensor assembly consists of a safing sensor and an airbag sensor.

In certain types of severe frontal or side impacts, the SRS airbag system triggers the airbag inflators. A chemical reaction in the inflators quickly fills the airbags with non-toxic gas to help restrain the motion of the occupants.

n If the SRS airbags deploy (inflate)

- l Bruising and slight abrasions may result from contact with a deploying (inflating) SRS airbag.
- l A loud noise and white powder will be emitted.
- l Parts of the airbag module (steering wheel hub, airbag cover and inflator) as well as the front seats and parts of the front and rear pillars, and roof side rail, may be hot for several minutes. The airbag itself may also be hot.
- l The windshield may crack.

n SRS airbag deployment conditions (front airbags)

- l The SRS front airbags will deploy in the event of an impact that exceeds the set threshold level (the level of force corresponding to an approximately 12 - 18 mph [20 - 30 km/h] frontal collision with a fixed wall that does not move or deform).

However, this threshold velocity will be considerably higher if the vehicle strikes an object, such as a parked vehicle or sign pole, which can move or deform on impact, or if the vehicle is involved in an underride collision (e.g. a collision in which the front of the vehicle "underrides", or goes under, the bed of a truck, etc.).

- l It is possible that in some collisions where the forward deceleration of the vehicle is very close to the designed threshold level, the SRS front airbags and the seat belt pretensioners may not activate together.
- l The SRS front passenger airbag will not activate if there is not passenger sitting in the front passenger seat. However, the front passenger airbag may deploy if luggage is put in the seat, or the seat belt is fastened, even if the seat is unoccupied. (→P. 121)

n SRS airbag deployment conditions (side and curtain shield airbags)

- l The SRS side and curtain shield airbags will deploy in the event of an impact that exceeds the set threshold level (the level of force corresponding to the impact force produced by an approximately 3300 lb. [1500 kg] vehicle colliding with the vehicle cabin from a direction perpendicular to the vehicle orientation at an approximate speed of 12 - 18 mph [20 - 30 km/h]).
- l The SRS side airbag on the passenger seat will not activate if there is no passenger sitting in the front passenger seat. However, the side airbag on the passenger seat may deploy if luggage is put in the seat, or the seat belt is fastened, even if the seat is unoccupied. (→P. 121)

1

Before driving

1-7. Safety information

n Conditions under which the SRS airbags may deploy (inflate), other than a collision

The SRS front airbags may also deploy if a serious impact occurs to the underside of your vehicle. Some examples are shown in the illustration.

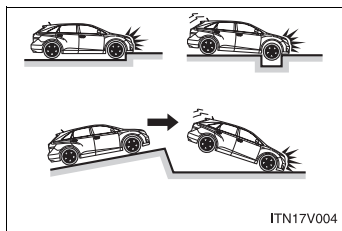

- | Hitting a curb, edge of pavement or hard surface
- | Falling into or jumping over a deep hole
- | Landing hard or vehicle falling

n Types of collisions that may not deploy the SRS airbag (front airbags)

The SRS front airbags are generally not designed to inflate if the vehicle is involved in a side or rear collision, if it rolls over, or if it is involved in a low-speed frontal collision. But, whenever a collision of any type causes sufficient forward deceleration of the vehicle, deployment of the SRS front airbags may occur.

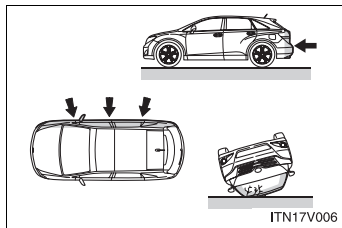

- | Collision from the side
- | Collision from the rear
- | Vehicle rollover

n Types of collisions that may not deploy the SRS airbag (side airbags and curtain shield airbags)

The SRS side airbag and curtain shield airbag system may not activate if the vehicle is subjected to a collision from the side at certain angles, or a collision to the side of the vehicle body other than the passenger compartment.

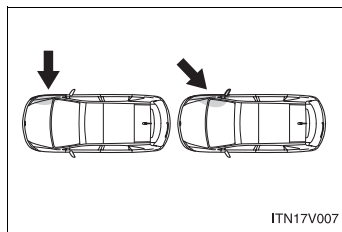

- | Collision from the side to the vehicle body other than the passenger compartment
- | Collision from the side at an angle

1

Before driving

The SRS side airbags and curtain shield airbags are not generally designed to inflate if the vehicle is involved in a frontal or rear collision, if it rolls over, or if it is involved in a low-speed side collision.

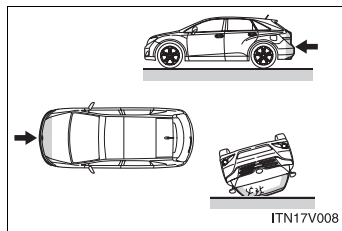

- | Collision from the front
- | Collision from the rear
- | Vehicle rollover

1-7. Safety information

n When to contact your Toyota dealer

In the following cases, contact your Toyota dealer as soon as possible.

- l Any of the SRS airbags have been inflated.

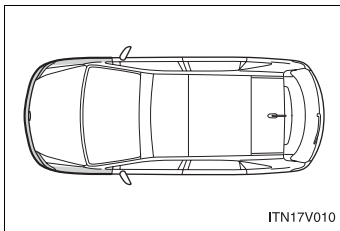

- l The front of the vehicle is damaged or deformed, or the vehicle was involved in an accident that was not severe enough to cause the SRS airbags to inflate.

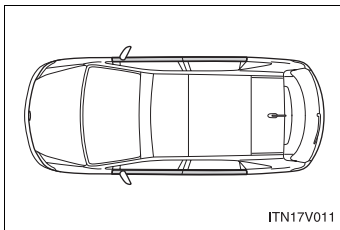

- l A portion of the doors is damaged or deformed, or the vehicle was involved in an accident that was not severe enough to cause the SRS side airbags and curtain shield airbags to inflate.

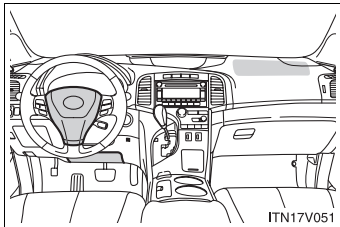

- l The pad section of the steering wheel, dashboard near the front passenger airbag or lower portion of the instrument panel is scratched, cracked or otherwise damaged.

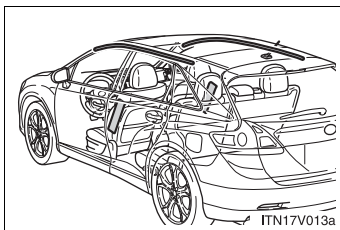

- l The surface of the seats with the side airbag is scratched, cracked, or otherwise damaged.
- l The portion of the front, center and rear pillars or roof side rail garnishes (padding) containing the curtain shield airbags inside is scratched, cracked or otherwise damaged.

! CAUTION**n SRS airbag precautions**

Observe the following precautions regarding the airbags.
Failure to do so may cause death or serious injury.

I The driver and all passengers in the vehicle must wear their seat belts properly.

The SRS airbags are supplemental devices to be used with the seat belts.

I The SRS driver airbag deploys with considerable force, and can cause death or serious injury especially if the driver is very close to the airbag. The National Highway Traffic Safety Administration (“NHTSA”) advises:

Since the risk zone for driver airbag is the first 2 - 3 in. (50 - 75 mm) of inflation, placing yourself 10 in. (250 mm) from your driver airbag provides you with a clear margin of safety. This distance is measured from the center of the steering wheel to your breastbone. If you sit less than 10 in. (250 mm) away now, you can change your driving position in several ways:

- Move your seat to the rear as far as you can while still reaching the pedals comfortably.
- Slightly recline the back of the seat.
Although vehicle designs vary, many drivers can achieve the 10 in. (250 mm) distance, even with the driver seat all the way forward, simply by reclining the back of the seat somewhat. If reclining the back of your seat makes it hard to see the road, raise yourself by using a firm, non-slippery cushion, or raise the seat if your vehicle has that feature.
- If your steering wheel is adjustable, tilt it downward. This points the airbag toward your chest instead of your head and neck.

The seat should be adjusted as recommended by NHTSA above, while still maintaining control of the foot pedals, steering wheel, and your view of the instrument panel controls.

1

Before driving

1-7. Safety information

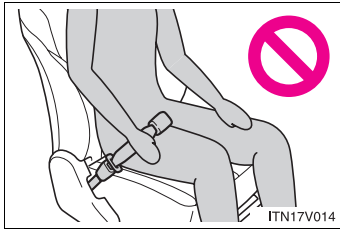
! CAUTION**n SRS airbag precautions**

I If the seat belt extender has been connected to the driver's seat belt buckle but the seat belt extender has not also been fastened to the latch plate of the driver's seat belt, the SRS driver's airbag system will judge that the driver is wearing the seat belt even though the seat belt has not been connected. In this case, the driver's airbag may not activate correctly in a collision, resulting in death or serious injury in the event of collision. Be sure to wear the seat belt with the seat belt extender.

I The SRS front passenger airbag also deploys with considerable force, and can cause death or serious injury especially if the front passenger is very close to the airbag. The front passenger seat should be as far from the airbag as possible with the seatback adjusted, so the front passenger sits upright.

I Improperly seated and/or restrained infants and children can be killed or seriously injured by a deploying airbag. An infant or child who is too small to use a seat belt should be properly secured using a child restraint system. Toyota strongly recommends that all infants and children be placed in the rear seats of the vehicle and properly restrained. The rear seats are the safest for infants and children. (→P. 127)

CAUTION

n SRS airbag precautions

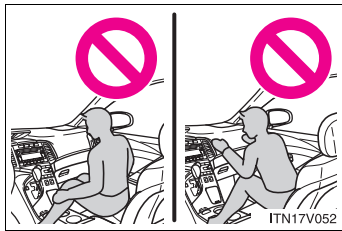

! Do not sit on the edge of the seat or lean against the dashboard.

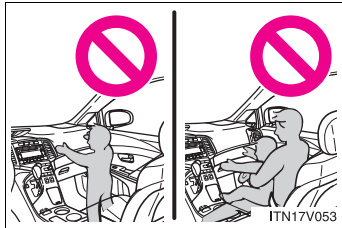

! Do not allow a child to stand in front of the SRS front passenger airbag unit or sit on the knees of a front passenger.

! Do not drive the vehicle while the driver or passenger have items resting on their knees.



! Do not lean against the door, the roof side rail or the front, center and rear pillars.



! Do not allow anyone to kneel on the passenger seats toward the door or put their head or hands outside the vehicle.

1

Before driving

1-7. Safety information

⚠ CAUTION

n SRS airbag precautions

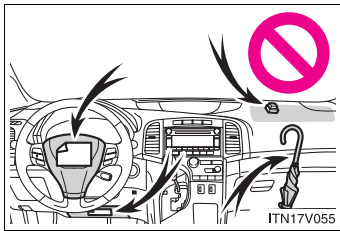

Do not attach anything to or lean anything against areas such as the dashboard or steering wheel pad or lower portion of the instrument panel. These items can become projectiles when SRS driver, front passenger and knee airbags deploy.



Do not attach anything to areas such as the door, windshield glass, side door glass, front, center and rear pillars, roof side rail or assist grip.

Do not hang coat hangers or other hard objects on the coat hooks. All of these items could become projectiles and seriously injure or kill you, should the SRS curtain shield airbag deploy.

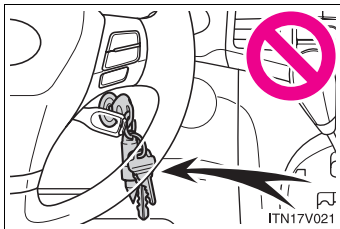

Vehicles without smart key system: Do not attach any heavy, sharp or hard objects such as keys or accessories to the key. The objects may restrict the SRS knee airbag inflation or be thrust into the driver's seat area by the force of the deploying airbag, thus causing a danger.

 CAUTION

n SRS airbag precautions

- I** If the vinyl cover is put on the area where the SRS knee airbag will deploy, be sure to remove it.
- I** Do not use seat accessories which cover the parts where the SRS side airbags inflate as they may interfere with inflation of the airbags.
- I** Do not strike or apply significant levels of force to the area of the SRS airbag components (→P. 109).
Doing so can cause the SRS airbags to malfunction.
- I** Do not touch any of the component parts immediately after the SRS airbags have deployed (inflated) as they may be hot.
- I** If breathing becomes difficult after the SRS airbag has deployed, open a door or window to allow fresh air in, or leave the vehicle if it is safe to do so. Wash off any residue as soon as possible to prevent skin irritation.
- I** If the areas where the SRS airbags are stored, such as the steering wheel pad and front, center and rear pillar garnishes, are damaged or cracked, have them replaced by your Toyota dealer.

1

Before driving

1-7. Safety information

CAUTION

n Modification and disposal of SRS airbag system components

Do not dispose of your vehicle or perform any of the following modifications without consulting your Toyota dealer.

The SRS airbag may malfunction or deploy (inflate) accidentally, causing death or serious injury.

- I** Installation, removal, disassembly and repair of the SRS airbags
- I** Repairs, modifications, removal or replacement of the steering wheel, instrument panel, dashboard, seats or seat upholstery, front, center and rear pillars or roof side rail
- I** Repairs or modifications of the front fender, front bumper, or side of the occupant compartment
- I** Installation of snow plows, winches, etc. to the front grille (bull bars, kangaroo bar etc.)
- I** Modifications to the vehicle's suspension system
- I** Installation of electronic devices such as mobile two-way radios or CD players
- I** Modifications to your vehicle for a person with a physical disability

1-7. Safety information

Front passenger occupant classification system

Your vehicle is equipped with a front passenger occupant classification system. This system detects the conditions of the front passenger seat and activates or deactivates the devices for front passenger.

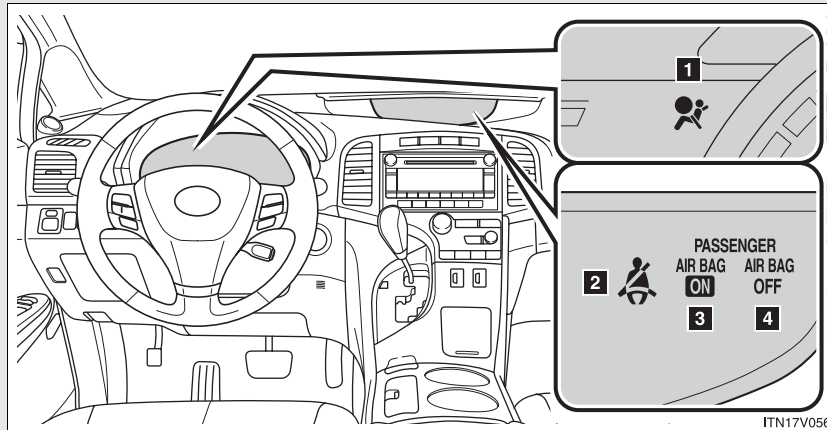

- 1 SRS warning light
- 2 Front passenger's seat belt reminder light
- 3 "AIR BAG ON" indicator light
- 4 "AIR BAG OFF" indicator light

1

Before driving

1-7. Safety information

Condition and operation in the front passenger occupant classification system

n **Adult*1**

Indicator/ warning light	“AIR BAG ON” and “AIR BAG OFF” indicator lights	“AIR BAG ON”
	SRS warning light	Off
	Front passenger’s seat belt reminder light	Flashing*2
Devices	Front passenger airbag	Activated
	Side airbag on the front passenger seat	
	Curtain shield airbag in the front passenger side	
	Front passenger’s seat belt pretensioner	

n **Child*3 or child restraint system*4**

Indicator/ warning light	“AIR BAG ON” and “AIR BAG OFF” indicator lights	“AIR BAG OFF”*5
	SRS warning light	Off
	Front passenger’s seat belt reminder light	Flashing*2
Devices	Front passenger airbag	Deactivated
	Side airbag on the front passenger seat	Activated
	Curtain shield airbag in the front passenger side	
	Front passenger’s seat belt pretensioner	

1-7. Safety information

n Unoccupied

Indicator/ warning light	“AIR BAG ON” and “AIR BAG OFF” indicator lights	Not illumi- nated
	SRS warning light	Off
	Front passenger’s seat belt reminder light	
Devices	Front passenger airbag	Deactivated
	Side airbag on the front passenger seat	Activated
	Curtain shield airbag in the front passenger side	
	Front passenger’s seat belt pretensioner	Deactivated

1

Before driving

1-7. Safety information

n System malfunction

Indicator/ warning light	“AIR BAG ON” and “AIR BAG OFF” indicator lights	“AIR BAG OFF”
	SRS warning light	On
	Front passenger’s seat belt reminder light	Off
Devices	Front passenger airbag	Deactivated
	Side airbag on the front passenger seat	Activated
	Curtain shield airbag in the front passenger side	
	Front passenger’s seat belt pretensioner	

- *1: The system judges a person of adult size as an adult. When a smaller adult sits in the front passenger seat, the system may recognize him/her as a child depending on his/her physique and posture.
- *2: In the event the front passenger does not wear a seat belt.
- *3: When a larger child who has outgrown a child restraint system sits in the front passenger seat, the system may recognize him/her as an adult depending on his/her physique or posture.
- *4: Never install a rear-facing child restraint system on the front passenger seat. A forward-facing child restraint system should only be installed on the front passenger seat when it is unavoidable. (→P. 127)
- *5: In case the indicator is not illuminated, consult this manual as for installing the child restraint system properly. (→P. 133)

⚠ CAUTION**n Front passenger occupant classification system precautions**

Observe the following precautions regarding front passenger occupant classification system.

Failure to do so may cause death or serious injury.

- ! Wear the seat belt properly.
- ! Make sure the front passenger's seat belt tab has not been left inserted into the buckle before someone sits in the front passenger seat.
- ! Make sure the "AIR BAG OFF" indicator light is not illuminated when using the seat belt extender for the front passenger seat. If the "AIR BAG OFF" indicator light is illuminated, disconnect the extender tongue from the seat belt buckle, then reconnect the seat belt. Reconnect the seat belt extender after making sure the "AIR BAG ON" indicator light is illuminated. If you use the seat belt extender while the "AIR BAG OFF" indicator light is illuminated, the front passenger airbag and side airbag on the front passenger side may not activate correctly, which could cause death or serious injury in the event of collision.
- ! Do not apply a heavy load to the front passenger seat or equipment (e.g. seatback pocket).
- ! Do not put weight on the front passenger seat by putting your hands or feet on the front passenger seatback from the rear passenger seat.
- ! Do not let a rear passenger lift the front passenger seat with their feet or press on the seatback with their legs.
- ! Do not put objects under the front passenger seat.

1

Before driving

1-7. Safety information

 CAUTION**n Front passenger occupant classification system precautions**

- I** Do not recline the front passenger seatback so far that it touches a second seat. This may cause the “AIR BAG OFF” indicator light to be illuminated, which indicates that the passenger’s airbags will not deploy in the event of a severe accident. If the seatback touches the second seat, return the seatback to a position where it does not touch the second seat. Keep the front passenger seatback as upright as possible when the vehicle is moving. Reclining the seatback excessively may lessen the effectiveness of the seat belt system.
- I** If an adult sits in the front passenger seat, the “AIR BAG ON” indicator light is illuminated. If the “AIR BAG OFF” indicator is illuminated, ask the passenger to sit up straight, well back in the seat, feet on the floor, and with the seat belt worn correctly. If the “AIR BAG OFF” indicator still remain illuminated, either ask the passenger to move to the rear seat, or if that is not possible, move the front passenger seat fully rearward.
- I** When it is unavoidable to install the forward-facing child restraint system on the front passenger seat, install the child restraint system on the front passenger seat in the proper order. (→P. 133)
- I** Do not modify or remove the front seat.
- I** Do not kick the front passenger seat or subject it to severe impact. Otherwise, the SRS warning light may come on to indicate a malfunction in the detection system. In this case, contact your Toyota dealer immediately.
- I** Child restraint systems installed on the rear seat should not contact the front seatbacks.
- I** Do not use a seat accessory, such as a cushion or seat cover, that covers the seat cushion surface.
- I** Do not modify or replace the upholstery of the front seat.

1-7. Safety information

Child restraint systems

A child restraint system for a small child or baby must itself be properly restrained on the seat with the lap portion of the lap/shoulder belt.

The laws of all 50 states of the U.S.A. and Canada now require the use of child restraint systems.

1

Before driving

Points to remember

Studies have shown that installing a child restraint on a rear seat is much safer than installing one to the front passenger seat.

- 1 Choose a child restraint system that suits your vehicle and is appropriate to the age and size of the child.
- 1 For installation details, follow the instructions provided with the child restraint system.
General installation instructions are provided in this manual.
(→P. 133)

1-7. Safety information

Types of child restraints

Child restraint systems are classified into the following 3 types according to the age and size of the child.

- ▶ Rear facing — Infant seat/convertible seat

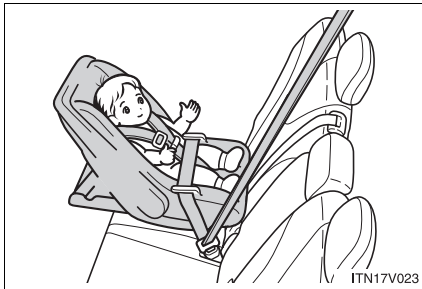

- ▶ Forward facing — Convertible seat



► **Booster seat**



1

Before driving

n When installing the child restraint system on the front passenger seat



When you have to use a child restraint system on the front passenger seat, adjust the following:

- 1 The seatback to the most upright position
- 1 The seat cushion to the fully rearward
- 1 The seat belt height to the lowest position

n Selecting an appropriate child restraint system

- 1 Use a child restraint system appropriate for the child until the child becomes large enough to properly wear the vehicle's seat belt.
- 1 If a child is too large for a child restraint system, sit the child on a rear seat and use the vehicle's seat belt. (→P. 72)

1-7. Safety information

 CAUTION**n Child restraint precautions**

- I** For effective protection in automobile accidents and sudden stops, a child must be properly restrained, using a seat belt or child restraint system depending on the age and size of the child. Holding a child in your arms is not a substitute for a child restraint system. In an accident, the child can be crushed against the windshield, or between you and the vehicle's interior.
- I** Toyota strongly urges the use of a proper child restraint system that conforms to the size of the child, installed on the rear seat. According to accident statistics, the child is safer when properly restrained in the rear seat than in the front seat.
- I** Never install a rear-facing child restraint system on the front passenger seat even if "AIR BAG OFF" indicator light illuminates. In the event of an accident, the force of the rapid inflation of the front passenger airbag can cause death or serious injury to the child if the rear-facing child restraint system is installed on the front passenger seat.
- I** A forward-facing child restraint system may be installed on the front passenger seat only when it is unavoidable. A child restraint system that requires a top tether strap should not be used in the front passenger seat since there is no top tether strap anchor for the front passenger seat. Adjust the seatback as upright as possible and always move the seat as far back as possible even if "AIR BAG OFF" indicator light is illuminated, because the front passenger airbag could inflate with considerable speed and force. Otherwise, the child may be killed or seriously injured.

⚠ CAUTION**n Child restraint precautions**

- I** Do not use the seat belt extender when installing a child restraint system on the front or rear passenger seat. If installing a child restraint system with the seat belt extender connected to the seat belt, the seat belt will not securely hold the child restraint system, which could cause death or serious injury to the child or other passengers in the event of a sudden stop, sudden swerve or an accident.
- I** Do not allow the child to lean his/her head or any part of his/her body against the door or the area of the seat, front, center and rear pillars or roof side rail from which the side airbags or curtain shield airbags deploy even if the child is seated in the child restraint system. It is dangerous if the side airbags and curtain shield airbags inflate, and the impact could cause death or serious injury to the child.
- I** Make sure you have complied with all installation instructions provided by the child restraint manufacturer and that the system is properly secured. If it is not secured properly, it may cause death or serious injury to the child in the event of a sudden stop, sudden swerve or an accident.

n Child restraint lock function belt precaution

Do not allow children to play with the child restraint lock function belt. If the belt becomes twisted around a child's neck, it will not be possible to pull the belt out leading to choking or other serious injuries that could result in death. If this occurs and the buckle cannot be unfastened, scissors should be used to cut the belt.

1

Before driving

1-7. Safety information

CAUTION

n When the child restraint system is not in use

- I** Keep the child restraint system properly secured on the seat even if it is not in use. Do not store the restraint unsecured in the passenger compartment.
- I** If it is necessary to detach the child restraint system, remove it from the vehicle or store it securely in the luggage compartment. This will prevent it from injuring passengers in the event of a sudden stop, sudden swerve or an accident.

1-7. Safety information

Installing child restraints

Follow the child restraint system manufacturer's instructions. Firmly secure child restraints to the rear seats using the LATCH anchors or a seat belt. Attach the top tether strap when installing a child restraint.

The lap/shoulder belt can be used if your child restraint system is not compatible with the LATCH (Lower Anchors and Tethers for Children) system.

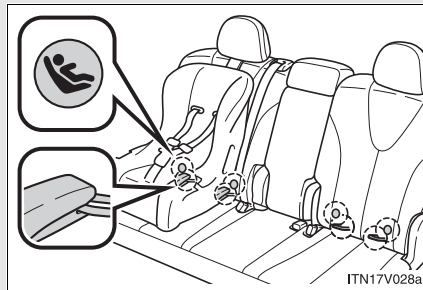

Child restraint LATCH anchors

LATCH anchors are provided for the outboard rear seat. (Buttons displaying the location of the anchors are attached to the seats.)

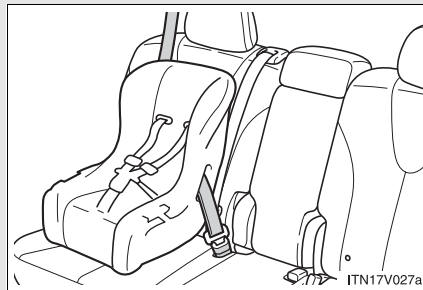

Seat belts equipped with a child restraint locking mechanism (ALR/ELR belts except driver's seat belt) (→P. 72)

1

Before driving

1-7. Safety information

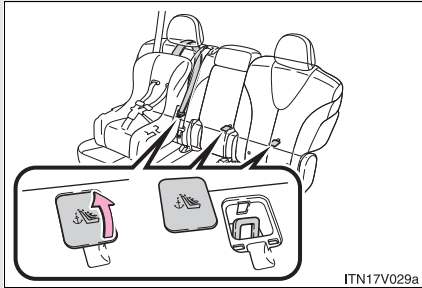

Anchor bracket (for top tether strap)

Anchor brackets are provided for all rear seats.

Installation with LATCH system

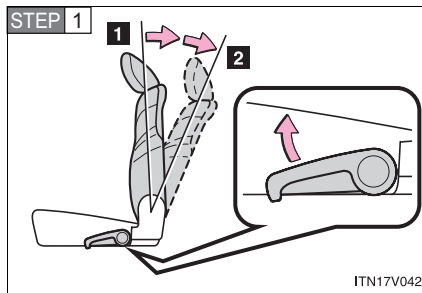

Fold the seatback while pulling the lever. Return the seatback and secure it as upright as possible (1st lock position). Adjust the seatback to the 3rd lock position. (→P. 67)

- 1** 1st lock position
- 2** 3rd lock position

► Type A

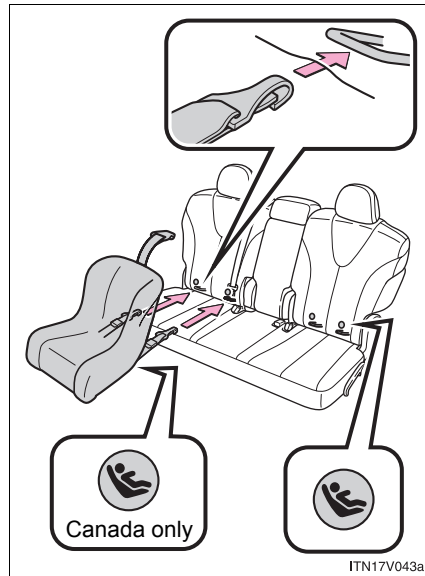

STEP 2 Widen the gap between the seat cushion and seatback slightly.

STEP 3 Latch the hooks of the lower straps onto the LATCH anchors.

The bars are installed in the clearance between the seat cushion and seatback.

STEP 4 If the child restraint has a top tether strap, the top tether strap should be latched onto the top tether strap anchor.

For owners in Canada:
The symbol on a child restraint system indicates the presence of a lower anchorage system.

1

Before driving

1-7. Safety information

► Type B

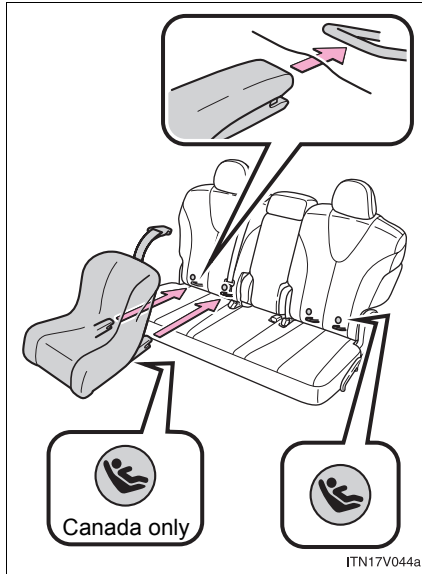

STEP 2 Widen the gap between the seat cushion and seatback slightly.

STEP 3 Latch the buckles onto the LATCH anchors.

The bars are installed in the clearance between the seat cushion and seatback.

STEP 4 If the child restraint has a top tether strap, the top tether strap should be latched onto the top tether strap anchor.

For owners in Canada:
The symbol on a child restraint system indicates the presence of a lower anchorage system.

Installing child restraints using a seat belt (child restraint lock function belt)

n Rear-facing — Infant seat/convertible seat

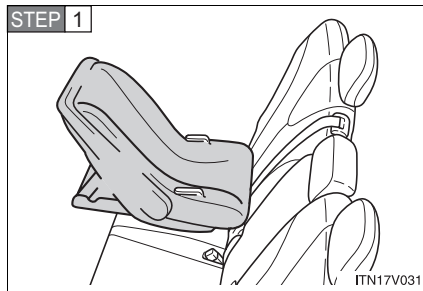

Place the child restraint system on the rear seat facing the rear of the vehicle.

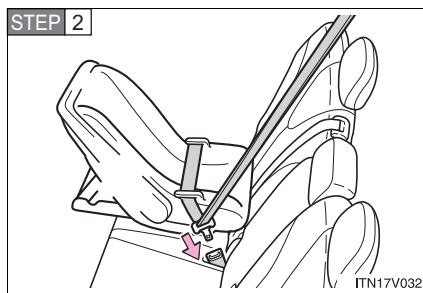

Run the seat belt through the child restraint system and insert the plate into the buckle. Make sure that the belt is not twisted.

1

Before driving

1-7. Safety information

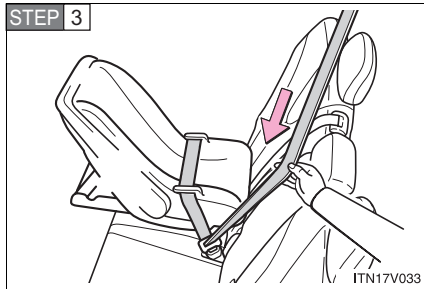

Fully extend the shoulder belt and then allow it to retract slightly in order to activate the ALR lock mode.

Lock mode allows the seat belt to retract only.

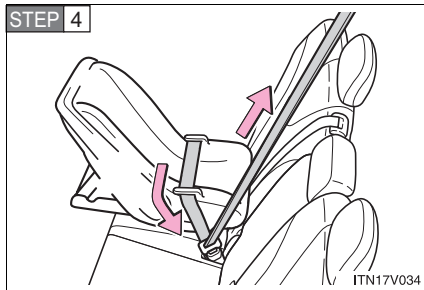

While pushing the child restraint system down into the rear seat, allow the shoulder belt to retract until the child restraint system is securely in place.

After the shoulder belt has retracted to a point where there is no slack in the belt, pull the belt to check that it cannot be extended.

n Forward-facing — Convertible seat

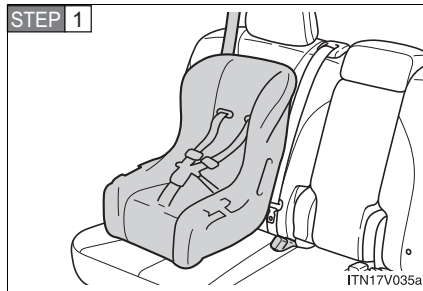

Place the child restraint system on the seat facing the front of the vehicle.

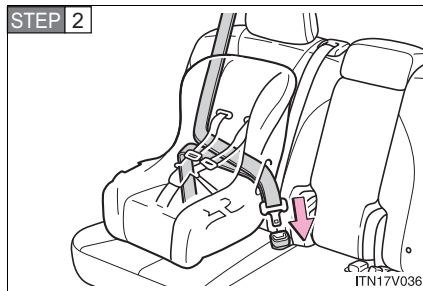

Run the seat belt through the child restraint system and insert the plate into the buckle. Make sure that the belt is not twisted.

1

Before driving

1-7. Safety information

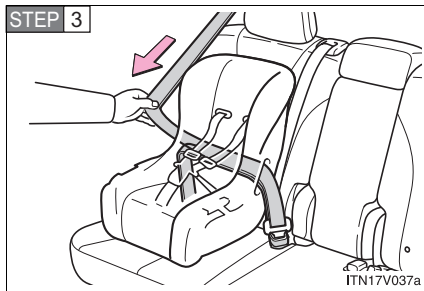

Fully extend the shoulder strap and then allow it to retract slightly into the ALR lock mode.

Lock mode allows the seat belt to retract only.

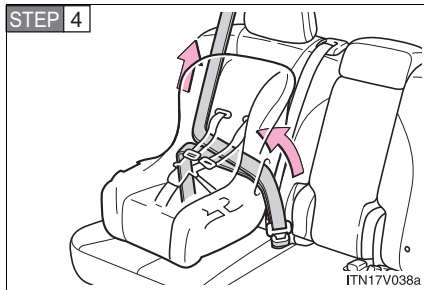

While pushing the child restraint system into the rear seat, allow the shoulder belt to retract until the child restraint system is securely in place.

After the shoulder belt has retracted to a point where there is no slack in the belt, pull the belt to check that it cannot be extended.

STEP 5 If the child restraint has a top tether strap, the top tether strap should be latched onto the top tether strap anchor. (→P. 142)

n Booster seat

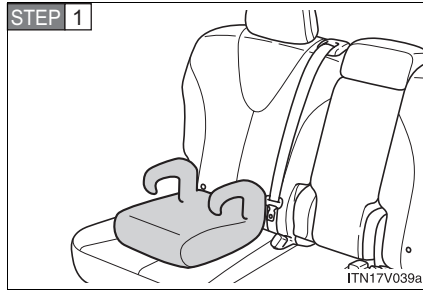

Place the booster seat on the seat facing the front of the vehicle.

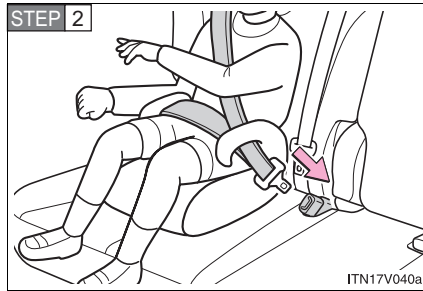

Sit the child in the booster seat. Fit the seat belt to the booster seat according to the manufacturer's instructions and insert the plate into the buckle. Make sure that the belt is not twisted.

Check that the shoulder belt is correctly positioned over the child's shoulder, and that the lap belt is as low as possible. (→P. 72)

1

Before driving

1-7. Safety information

Removing a child restraint installed with a seat belt

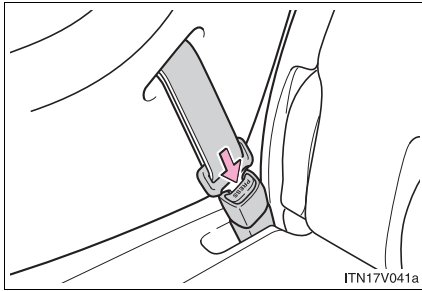

Press the buckle release button and fully retract the seat belt.

Child restraint systems with a top tether strap

STEP 1 Secure the child restraint using a seat belt or lower anchors, and do the following.

► Outside

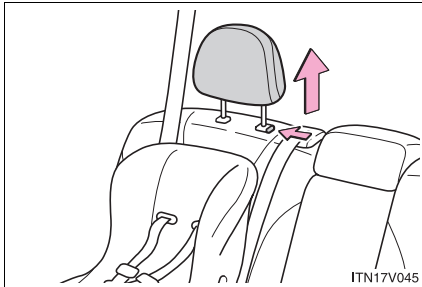

Adjust the head restraint to the utmost position.

► Center

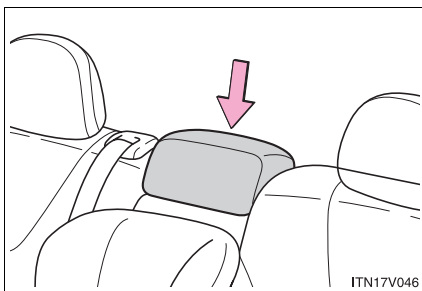

Lower the head restraint to the lowest position.

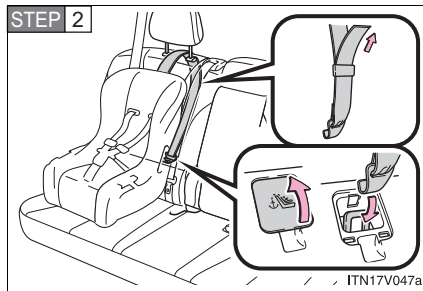

Open the anchor bracket cover, latch the hook onto the anchor bracket and tighten the top tether strap.

Make sure the top tether strap is securely latched.

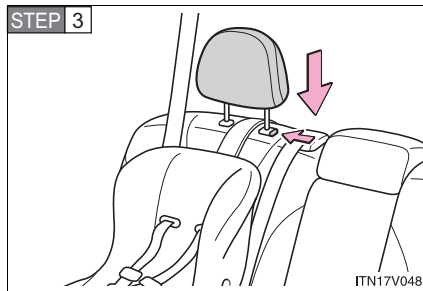

Outside only: Adjust the head restraint to the downmost position.

1

Before driving

n Laws and regulations pertaining to anchors

The LATCH system conforms to FMVSS225 or CMVSS210.2.
Child restraint systems conforming to FMVSS213 or CMVSS213 specifications can be used.
This vehicle is designed to conform to the SAE J1819.

⚠ CAUTION

n When installing a booster seat

Do not fully extend the shoulder belt to prevent the belt from going to ALR lock mode: (→P. 74)

ALR mode causes the belt to tighten only which could cause injury or discomfort to the child.

1-7. Safety information

! CAUTION**n When installing a child restraint system**

Follow the directions given in the child restraint system installation manual and fix the child restraint system securely in place.

If the child restraint system is not correctly fixed in place, the child or other passengers may be seriously injured or even killed in the event of sudden braking, sudden swerving or an accident.

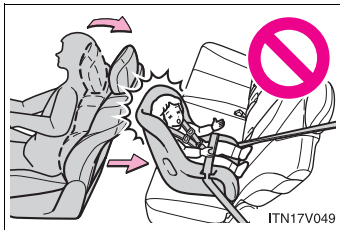

I If the driver's seat interferes with the child restraint system and prevents it from being attached correctly, attach the child restraint system to the right-hand rear seat.

I Adjust the front passenger seat so that it does not interfere with the child restraint system.

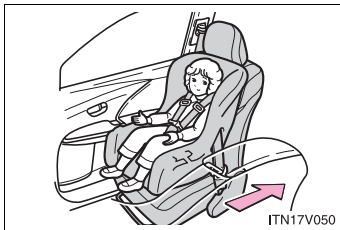

I Only put a forward-facing child restraint system on the front seat when unavoidable. When installing a forward-facing child restraint system on the front passenger seat, move the seat as far back as possible even if "AIR BAG OFF" indicator light is illuminated. Failing to do so may result in death or serious injury if the airbags deploy (inflate).

 CAUTION

n When installing a child restraint system

- | When installing a child restraint system in the rear center seat, adjust both seatbacks at the same angle. Otherwise, the child restraint system cannot be securely restrained and this may cause death or serious injuries in the event of sudden braking, sudden swerving or an accident.
- | When using the LATCH anchors for a child restraint system, adjust the seatback as upright as possible.
- | When a booster seat is installed, always ensure that the shoulder belt is positioned across the center of the child's shoulder. The belt should be kept away from the child's neck, but not so that it could fall off the child's shoulder. Failing to do so may result in death or serious injury in the event of sudden braking, sudden swerving or an accident.
- | Ensure that the belt and tab are securely locked and the seat belt is not twisted.
- | Push and pull the child restraint system from side to side and forward to be sure it is secure.
- | After securing a child restraint system, never adjust the seat.
- | Follow all installation instructions provided by the child restraint system manufacturer.

1

Before driving

1-7. Safety information

CAUTION

n Do not use a seat belt extender

If a seat belt extender is used when installing a child restraint system, the seat belt will not securely hold the child restraint system, which could cause death or serious injury to the child or other passengers in the event of sudden braking, sudden swerving or an accident.

n To correctly attach a child restraint system to the anchors

When using the LATCH anchors, be sure that there are no foreign objects around the anchors and that the seat belt is not caught behind the child restraint. Make sure the child restraint system is securely attached, or it may cause death or serious injury to the child or other passengers in the event of a sudden stop, sudden swerve or an accident.

When driving

2

2-1. Driving procedures

Driving the vehicle.....	148
Engine (ignition) switch (vehicles with smart key system).....	159
Engine (ignition) switch (vehicles without smart key system).....	163
Automatic transmission.....	166
Turn signal lever	171
Parking brake.....	172
Horn	173

2-2. Instrument cluster

Gauges and meters	174
Indicators and warning lights.....	177
Multi-information display (TFT type).....	180
Multi-information display (LCD type)	194

2-3. Operating the lights and wipers

Headlight switch	198
Automatic High Beam (vehicles with discharge headlights)	202
Fog light switch	209
Windshield wipers and washer	210
Rear window wiper and washer	212

2-4. Using other driving systems

Cruise control	213
Rear view monitor system	217
Hill-start assist control.....	222
Driving assist systems	224

2-5. Driving information

Utility vehicle precautions	230
Cargo and luggage	235
Vehicle load limits	240
Winter driving tips	242
Trailer towing	247
Dinghy towing	259

2-1. Driving procedures

Driving the vehicle

The following procedures should be observed to ensure safe driving.

n Starting the engine

→P. 159, 163

n Driving

STEP 1 With the brake pedal depressed, shift the shift lever to "D".
(→P. 166)

STEP 2 Release the parking brake. (→P. 172)

STEP 3 Gradually release the brake pedal and gently push the accelerator pedal to accelerate the vehicle.

n Stopping

STEP 1 With the shift lever in "D", depress the brake pedal.

STEP 2 If necessary, set the parking brake.

When the vehicle is stopped for an extended period of time, shift the shift lever to "P" or "N". (→P. 166)

n Parking the vehicle

STEP 1 With the shift lever in "D", depress the brake pedal.

STEP 2 Set the parking brake. (→P. 172)

STEP 3 Shift the shift lever to "P". (→P. 166)

When parking on a hill, if necessary, block the wheels.

- STEP 4** Vehicles with smart key system:
Turn the “ENGINE START STOP” switch off and stop the engine.
- Vehicles without smart key system:
Turn the engine switch to the “LOCK” position and stop the engine.
- STEP 5** Lock the door, making sure that you have the key on your person.

2

Starting on a steep incline

- STEP 1** Firmly set the parking brake and shift the shift lever to “D”.
- STEP 2** Gently depress the accelerator pedal.
- STEP 3** Release the parking brake.

When driving

n Starting off on a hill

Hill-start assist control will operate. (→P. 222)

n Driving in the rain

- l Drive carefully when it is raining, because visibility will be reduced, the windows may become fogged-up, and the road will be slippery.
- l Drive carefully when it starts to rain, because the road surface will be especially slippery.
- l Refrain from high speeds when driving on an expressway in the rain, because there may be a layer of water between the tires and the road surface, preventing the steering and brakes from operating properly.

2-1. Driving procedures

n **Breaking in your new Toyota**

To extend the life of the vehicle, the following precautions are recommended to observe:

- l For the first 200 miles (300 km):
Avoid sudden stops.
- l For the first 500 miles (800 km):
Do not tow a trailer.
- l For the first 1000 miles (1600 km):
 - Do not drive at extremely high speeds.
 - Avoid sudden acceleration.
 - Do not drive continuously in the low gears.
 - Do not drive at a constant speed for extended periods.

n **Drum-in-disc type parking brake system**

Your vehicle has a drum-in-disc type parking brake system. This type of brake system needs bedding-down of the brake shoes periodically or whenever the parking brake shoes and/or drums are replaced.

Have your Toyota dealer perform the bedding-down.

n **Operating your vehicle in a foreign country**

Comply with the relevant vehicle registration laws and confirm the availability of the correct fuel. (→P. 611)

⚠ CAUTION**n When starting the vehicle**

Always keep your foot on the brake pedal while stopped with the engine running. This prevents the vehicle from creeping.

n When driving the vehicle

I Do not drive if you are unfamiliar with the location of the brake and accelerator pedals to avoid depressing the wrong pedal.

- Accidentally depressing the accelerator pedal instead of the brake pedal will result in sudden acceleration that may lead to an accident that could result in death or serious injury.
- When backing up, you may twist your body around, leading to a difficulty in operating the pedals. Make sure to operate the pedals properly.
- Make sure to keep a correct driving posture even when moving the vehicle only slightly, allowing you to depress the brake and accelerator pedals properly.
- Depress the brake pedal using your right foot. Depressing the brake pedal using your left foot may delay response in an emergency, resulting in an accident.

I Do not drive the vehicle over or stop the vehicle near flammable materials. The exhaust system and exhaust gases can be extremely hot. This may cause a fire if there is any flammable material nearby.

I Do not let the vehicle roll backwards while the shift lever is in a driving position, or roll forward while the shift lever is in "R". Doing so may result in an accident or damage to the vehicle.

I If the smell of exhaust is noticed inside the vehicle, open the windows and check that the back door is closed. Large amounts of exhaust in the vehicle can cause driver drowsiness and an accident, resulting in death or a serious health hazard. Have the vehicle inspected by your Toyota dealer immediately.

I Do not shift the shift lever to "P" while the vehicle is moving. Doing so can damage the transmission and may result in a loss of vehicle control.

I Do not shift the shift lever to "R" while the vehicle is moving forward. Doing so can damage the transmission and may result in a loss of vehicle control.

2

When driving

2-1. Driving procedures

 CAUTION

- I Do not shift the shift lever to “D” while the vehicle is moving backward. Doing so can damage the transmission and may result in a loss of vehicle control.
- I Moving the shift lever to “N” while the vehicle is moving will disengage the engine from the transmission. Engine braking is not available when “N” is selected.
- I During normal driving, do not turn off the engine. Turning the engine off while driving will not cause loss of steering or braking control, but the power assist to these systems will be lost. This will make it more difficult to steer and brake, so you should pull over and stop the vehicle as soon as it is safe to do so.
However, in the event of an emergency, such as if it becomes impossible to stop the vehicle in the normal way: →P. 605.
- I Use engine braking (downshift) to maintain a safe speed when driving down a steep hill.
Using the brakes continuously may cause the brakes to overheat and lose effectiveness. (→P. 167)
- I When stopped on an inclined surface, use the brake pedal and parking brake to prevent the vehicle from rolling backward or forward and causing an accident.
- I Do not adjust the position of the steering wheel, the seat, or the inside or outside rear view mirrors while driving.
Doing so may result in a loss of vehicle control that can cause accidents that may result in death or serious injury.
- I Always check that all passengers’ arms, heads or other parts of their bodies are not outside the vehicle, as this may result in death or serious injury.
- I Do not drive in excess of the speed limit. Even if the legal speed limit permits it, do not drive over 85 mph (140 km/h) unless your vehicle has high-speed capability tires. Driving over 85 mph (140 km/h) may result in tire failure, loss of control and possible injury. Be sure to consult a tire dealer to determine whether the tires on your vehicle are high-speed capability tires or not before driving at such speeds.

⚠ CAUTION**n When driving on slippery road surfaces**

- ! Sudden braking, acceleration and steering may cause tire slippage and reduce your ability to control the vehicle, resulting in an accident.
- ! Sudden changes in engine speed, such as engine braking caused by up-shifting or down-shifting, may cause the vehicle to skid, resulting in an accident.
- ! After driving through a puddle, lightly depress the brake pedal to make sure that the brakes are functioning properly. Wet brake pads may prevent the brakes from functioning properly. If the brakes on only one side are wet and not functioning properly, steering control may be affected, resulting in an accident.

n When shifting the shift lever

Be careful not to shift the shift lever with the accelerator pedal depressed. This may lead to unexpected rapid acceleration of the vehicle that may cause an accident and result in death or serious injury.

n When the vehicle is stopped

- ! Do not race the engine.
If the vehicle is in any gear other than "P" or "N", the vehicle may accelerate suddenly and unexpectedly, and may cause an accident.
- ! Do not leave the vehicle with the engine running for a long time.
If such a situation cannot be avoided, park the vehicle in an open space and check that exhaust fumes do not enter the vehicle interior.
- ! In order to prevent accidents due to the vehicle rolling away, always keep depressing the brake pedal while the engine is running, and apply the parking brake as necessary.
- ! If the vehicle is stopped on an incline, in order to prevent accidents caused by the vehicle rolling forward or backward, always depress the brake pedal and securely apply the parking brake as needed.
- ! Avoid revving or racing the engine.
Running the engine at high speed while the vehicle is stopped may cause the exhaust system to overheat, which could result in a fire if combustible material is nearby.

2

When driving

2-1. Driving procedures

CAUTION

n When the vehicle is parked

- I** Do not leave glasses, cigarette lighters, spray cans, or soft drink cans in the vehicle when it is in the sun.
Doing so may result in the following:
 - Gas may leak from a cigarette lighter or spray can, and may lead to a fire.
 - The temperature inside the vehicle may cause the plastic lenses and plastic material of eye glasses to deform or crack.
 - Soft drink cans may fracture, causing the contents to spray over the interior of the vehicle, and may also cause a short circuit in the vehicle's electrical components.
- I** Always apply the parking brake, shift the shift lever to "P", stop the engine and lock the vehicle.
Do not leave the vehicle unattended while the engine is running.
- I** Do not touch the exhaust pipe while the engine is running or immediately after turning the engine off.
Doing so may cause burns.
- I** Do not leave the engine running in an area with snow build-up, or where it is snowing. If snowbanks build up around the vehicle while the engine is running, exhaust gases may collect and enter the vehicle. This may lead to death or a serious health hazard.

 **CAUTION**

n Exhaust gases

Exhaust gases include harmful carbon monoxide (CO) that is colorless and odorless. Inhaling exhaust gases may lead to death or a serious health hazard.

I If the vehicle is in a poorly ventilated area, stop the engine. In a closed area, such as a garage, exhaust gases may collect and enter the vehicle. This may lead to death or a serious health hazard.

I The exhaust should be checked occasionally. If there is a hole or crack caused by corrosion, damage to a joint or abnormal exhaust noise, be sure to have the vehicle inspected and repaired by your Toyota dealer. Failure to do so may allow exhaust gases to enter the vehicle, resulting in death or a serious health hazard.

n When taking a nap in the vehicle

Always turn the engine off. Otherwise, you may accidentally move the shift lever or depress the accelerator pedal, which could cause an accident or fire due to engine overheating. Additionally, if the vehicle is parked in a poorly ventilated area, exhaust gases may collect and enter the vehicle, leading to death or a serious health hazard.

2

When driving

2-1. Driving procedures

CAUTION

n When braking the vehicle

- I** When the brakes are wet, drive more cautiously.
Braking distance increases when the brakes are wet, and may cause one side of the vehicle to brake differently than the other side. Also the parking brake may not securely hold the vehicle.
- I** If the power brake assist function does not operate, do not follow other vehicles closely and avoid downhill or sharp turns that require braking.
In this case, braking is still possible, but it will require more force on the pedal than usual. Braking distance may also increase.
- I** Do not pump the brake pedal if the engine stalls.
Each push on the brake pedal uses up the reserve for the power-assisted brakes.
- I** The brake system consists of 2 individual hydraulic systems: if one of the systems fails, the other will still operate. In this case, the brake pedal should be depressed more firmly than usual and braking distance becomes longer.
Do not drive your vehicle with only a single brake system. Have your brakes fixed immediately.

n If the vehicle becomes stuck or bogged (AWD models)

Do not spin the wheels recklessly when any of the tires is up in the air, or stuck in sand or mud, etc. This may damage the drive system components or propel the vehicle forward (or in another direction) and cause an accident.

 NOTICE**n While driving the vehicle**

- I** Do not depress the accelerator and brake pedals at the same time during driving. If the brake pedal is depressed while driving with the accelerator pedal depressed, driving torque may be restrained.
- I** Do not use the accelerator pedal or depress accelerator and brake pedals together to hold the vehicle on a hill.

n When parking the vehicle

Always put the shift lever in "P". Failure to do so may cause the vehicle to move or the vehicle may accelerate suddenly if the accelerator pedal is accidentally depressed.

n Avoiding damage to vehicle parts

- I** Do not turn the steering wheel fully in either direction and hold it there for a long time.
Doing so may damage the power steering motor.
- I** When driving over bumps in the road, drive as slowly as possible to avoid damaging the wheels, underside of the vehicle, etc.

n If you hear a squealing or scraping noise (brake pad wear limit indicators)

Have your Toyota dealer check and replace the brake pads as soon as possible.

The rotor damage can result if the pads are not replaced when needed.

It is dangerous to drive the vehicle when the wear limits of the brake pads and/or that of the brake discs are exceeded.

2

When driving

2-1. Driving procedures

NOTICE

n If you get a flat tire while driving

A flat or damaged tire may cause the following situations. Hold the steering wheel firmly and gradually press the brake pedal to slow down the vehicle.

- | It may be difficult to control your vehicle.
- | The vehicle will make abnormal sounds.
- | The vehicle will behave abnormally.

Replace a flat tire with a new one. (→P. 576)

n When encountering flooded roads

Do not drive on a road that has flooded after heavy rain etc. Doing so may cause the following serious damage to the vehicle.

- | Engine stalling
- | Short in electrical components
- | Engine damage caused by water immersion

In the event that you drive on a flooded road and the vehicle is flooded, be sure to have your Toyota dealer check the following.

- | Brake function
- | Changes in quantity and quality of oil and fluid used for the engine, transaxle, transfer (AWD models), differential (AWD models), etc.
- | Lubricant condition for the propeller shaft (AWD models), bearings and suspension joints (where possible) and the function of all joints, bearings, etc.

2-1. Driving procedures

Engine (ignition) switch (vehicles with smart key system)

Performing the following operations when carrying the electronic key on your person starts the engine or changes “ENGINE START STOP” switch modes.

n Starting the engine

STEP 1 Check that the parking brake is set.

STEP 2 Check that the shift lever is set in “P”.

STEP 3 Sit in the driver’s seat and firmly depress the brake pedal.

The “ENGINE START STOP” switch indicator turns green.

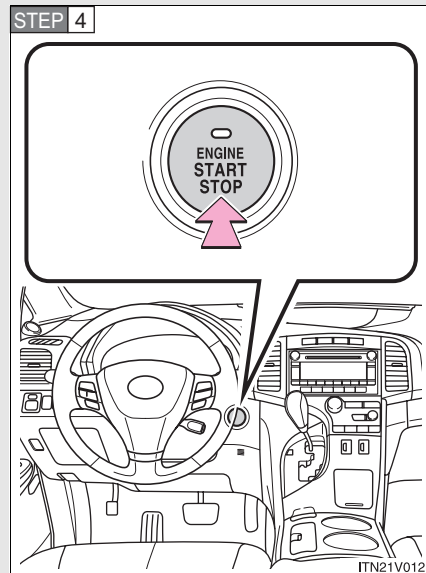

Press the “ENGINE START STOP” switch.

The engine can be started from any mode.

Continue depressing the brake pedal until the engine is completely started. The engine will crank until it starts or for up to 30 seconds, whichever is less.

2

When driving

2-1. Driving procedures

n Changing “ENGINE START STOP” switch mode

Modes can be changed by pressing the “ENGINE START STOP” switch with the brake pedal released. (The mode changes each time the switch is pressed.)

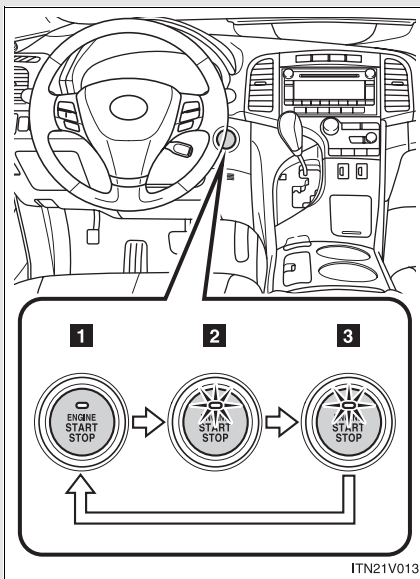

1 OFF *

Emergency flashers can be used.

2 ACCESSORY mode

Some electrical components such as the audio system can be used.

The “ENGINE START STOP” switch indicator turns amber.

3 IGNITION ON mode

All electrical components can be used.

The “ENGINE START STOP” switch indicator turns amber.

*: If the shift lever is in a position other than “P” when turning off the engine, the “ENGINE START STOP” switch will be turned to ACCESSORY mode, not to OFF.

n When the steering lock cannot be released

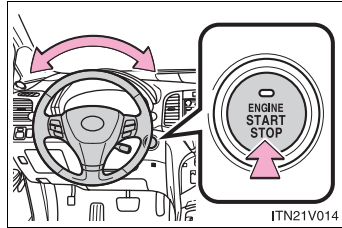

The green indicator light on the “ENGINE START STOP” switch will flash and a message will be shown on the multi-information display (TFT type only). To free it, press the “ENGINE START STOP” switch while turning the steering wheel slightly in either direction.

n If the engine does not start

The engine immobilizer system may not have been deactivated. (→P. 97)

n When the “ENGINE START STOP” switch indicator flashes in amber

The system may be malfunctioning. Have the vehicle inspected by your Toyota dealer immediately.

n Auto power off function

If the vehicle is left in ACCESSORY or IGNITION ON mode (engine is not running) for more than an hour with the shift lever in “P”, the “ENGINE START STOP” switch will automatically turn off.

n Electronic key battery depletion

→P. 35

n When the electronic key battery is discharged

→P. 592

n Conditions affecting operation

→P. 33

n Note for the entry function

→P. 36

2

When driving

2-1. Driving procedures

CAUTION

n When starting the engine

Always start the engine while sitting in the driver's seat. Do not depress the accelerator pedal while starting the engine under any circumstances. Doing so may cause an accident resulting in death or serious injury.

n Stopping the engine in an emergency

If you want to stop the engine in an emergency while driving the vehicle, push and hold the "ENGINE START STOP" switch for more than 3 seconds. However, do not touch the "ENGINE START STOP" switch while driving except in an emergency. Turning the engine off while driving will not cause loss of steering or braking control, but the power assist to these systems will be lost. This will make it more difficult to steer and brake, so you should pull over and stop the vehicle as soon as it is safe to do so.

NOTICE

n To prevent battery discharge

Do not leave the "ENGINE START STOP" switch in ACCESSORY or IGNITION ON mode for long periods without the engine running.

n When starting the engine

- l** Do not race a cold engine.
- l** If the engine becomes difficult to start or stalls frequently, have the engine checked immediately.

2-1. Driving procedures

Engine (ignition) switch (vehicles without smart key system)

n Starting the engine

- STEP 1** Check that the parking brake is set.
- STEP 2** Check that the shift lever is set in "P".
- STEP 3** Sit in the driver's seat and firmly depress the brake pedal.
- STEP 4** Turn the engine switch to the "START" position and start the engine.

n Engine (ignition) switch

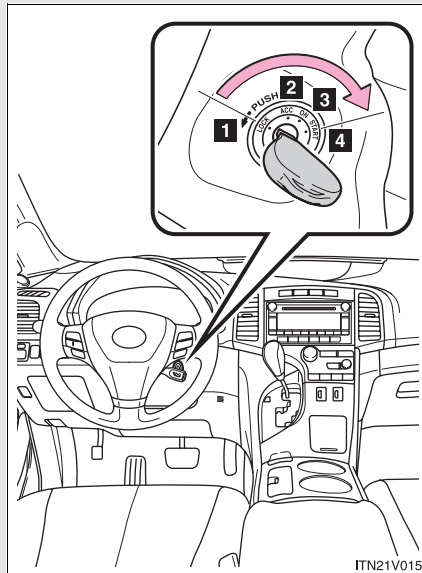

1 "LOCK"

The steering wheel is locked and the key can be removed. (The key can be removed only when the shift lever is in "P".)

2 "ACC"

Some electrical components such as the audio system can be used.

3 "ON"

All electrical components can be used.

4 "START"

For starting the engine.

2

When driving

2-1. Driving procedures

n Turning the key from “ACC” to “LOCK”

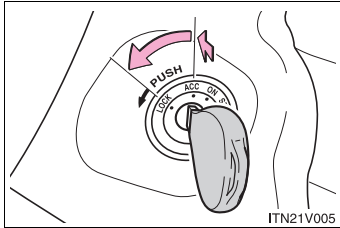

STEP 1 Shift the shift lever to “P”.

STEP 2 Push in the key and turn to the “LOCK” position.

n When the steering lock cannot be released

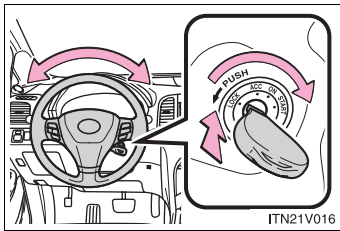

When starting the engine, the engine switch may seem stuck in the “LOCK” position. To free it, turn the key while turning the steering wheel slightly in either direction.

n If the engine does not start

The engine immobilizer system may not have been deactivated. (→P. 97)

n Key reminder function

A buzzer sounds if the driver’s door is opened, while the engine switch is in “LOCK” or “ACC” position to remind you to remove the key.

2-1. Driving procedures

 CAUTION

n When starting the engine

Always start the engine while sitting in the driver's seat. Do not depress the accelerator pedal while starting the engine under any circumstances. Doing so may cause an accident resulting in death or serious injury.

n While driving

Do not turn the engine switch to the "LOCK" position. If in an emergency, you must turn the engine off while the vehicle is moving, turn the key only to the "ACC" position.

2

When driving

 NOTICE

n To prevent battery discharge

Do not leave the key in the "ACC" or "ON" position for long periods without the engine running.

n When starting the engine

l Do not crank for more than 30 seconds at a time. This may overheat the starter and wiring systems.

l Do not race the cold engine.

l If the engine becomes difficult to start or stalls frequently, have the engine checked immediately.

2-1. Driving procedures

Automatic transmission

Select a shift position appropriate for the driving conditions.

n Shifting the shift lever

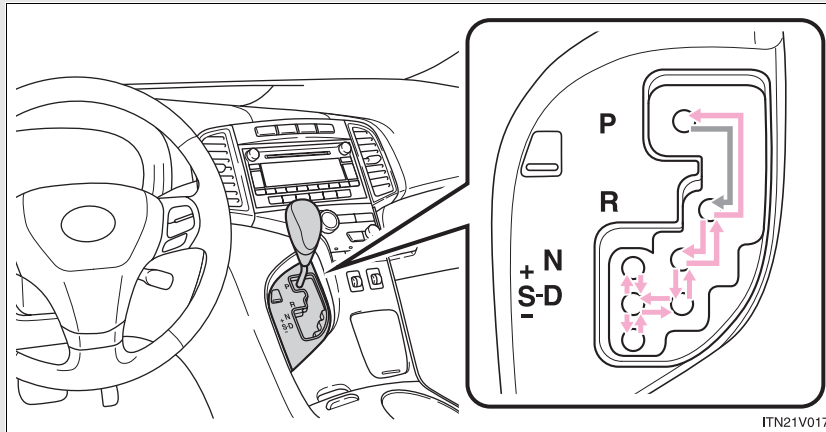

Vehicles with smart key system:

While the “ENGINE START STOP” switch is in IGNITION ON mode, depress the brake pedal and move the shift lever.

Vehicles without smart key system:

While the engine switch is in the “ON” position, depress the brake pedal and move the shift lever.

n Shift position uses

Shift position	Function
P	Parking the vehicle or starting the engine
R	Reversing
N	Neutral
D	Normal driving ^{*1}
S	S mode driving ^{*2} (→P. 168)

^{*1}: Shifting to the D position allows the system to select a gear suitable for the driving conditions.

Setting the shift lever to the D position is recommended for normal driving.

^{*2}: Selecting shift ranges using S mode restricts the upper limit of the possible gear ranges, controls engine braking forces, and prevents unnecessary upshifting.

2

When driving

2-1. Driving procedures

Changing shift ranges in S mode

Shift the shift lever to the S mode driving position and operate the shift lever.

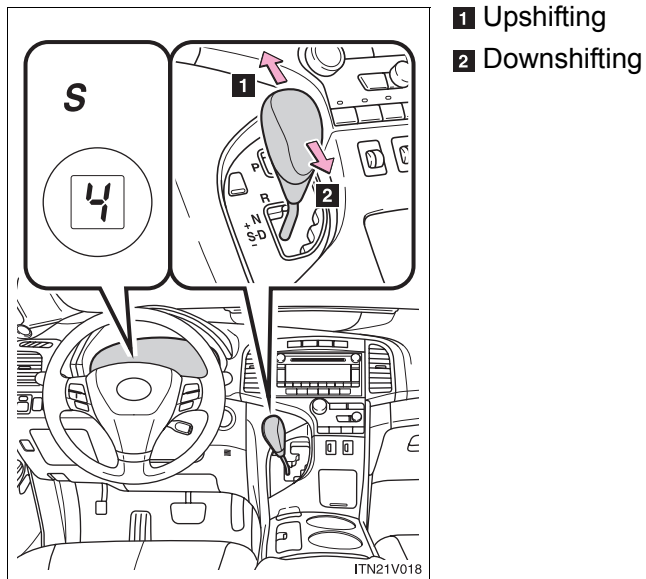

The initial shift range in S mode is set automatically to 5 or 4 according to vehicle speed. However, the initial shift range may be set to 3 if AI-SHIFT has operated while the shift lever was in the D position. (→P. 170)

2-1. Driving procedures

n Shift ranges and their functions

- 1 Automatically selecting gears between 1 and 6 according to vehicle speed and driving condition. (However the gear is limited according to selected shift range.)
- 1 You can choose from 6 levels of engine braking force.
- 1 A lower shift range will provide greater engine braking force than a higher shift range, and the engine speed will also increase.

2

When driving

2-1. Driving procedures

n **S mode**

- l When the shift range is 5 or lower, holding the shift lever toward “+” sets the shift range to 6.
- l To prevent excessive engine speed, a function was adopted that automatically selects a higher shift range before engine speed becomes too high.
- l To protect the automatic transmission, a function is adopted that automatically selects a higher shift range when the fluid temperature is high.

n **Downshifting restrictions warning buzzer (in the S mode)**

To help ensure safety and driving performance, downshifting operation may sometimes be restricted. In some circumstances, downshifting may not be possible even when the shift lever is operated. (The warning buzzer will sound twice.)

n **When driving with the cruise control system**

The engine brake will not operate in the S mode, even when downshifting to 5 or 4. (→P. 213)

n **If the shift lever cannot be shifted from P**

→P. 590

n **If the S indicator does not come on even after shifting the shift lever to S mode driving position**

This may indicate a malfunction in the automatic transmission system. Have the vehicle inspected by your Toyota dealer immediately.
(In this situation, the transmission will operate in the same manner as when the shift lever is in D.)

n **AI-SHIFT**

AI-SHIFT automatically selects the suitable gear according to driver performance and driving conditions.

AI-SHIFT automatically operates when the shift lever is in the D position.
(Shifting the shift lever to the S mode driving position cancels the function.)

2-1. Driving procedures

Turn signal lever

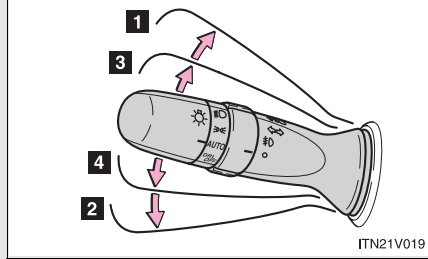
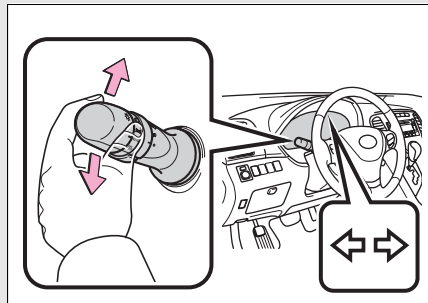

1 Right turn

2 Left turn

3 Move and hold the lever partway to signal a lane change.

The right hand signal will flash until you release the lever.

4 Move and hold the lever partway to signal a lane change.

The left hand signal will flash until you release the lever.

2

When driving

n Turn signals can be operated when

- ▶ Vehicles with smart key system

The "ENGINE START STOP" switch is in IGNITION ON mode.

- ▶ Vehicles without smart key system

The engine switch is in the "ON" position.

n If the indicators flash faster than usual

Check that a light bulb in the front or rear turn signal lights has not burned out.

2-1. Driving procedures

Parking brake

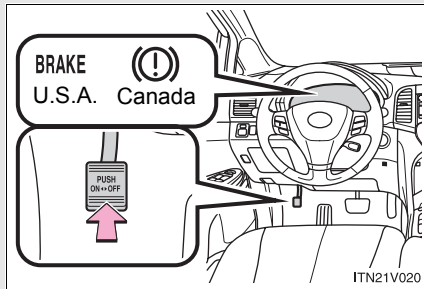

Sets the parking brake*
(Depressing the pedal again releases the parking brake.)

*: Fully depress the parking brake pedal with your left foot while depressing the brake pedal with your right foot.

n Usage in winter time

See "Winter driving tips" for parking brake usage in winter time. (→P. 242)

⚠ NOTICE

n Before driving

Fully release the parking brake.

Driving the vehicle with the parking brake set will lead to brake components overheating, which may affect braking performance and increase brake wear.

2-1. Driving procedures

Horn

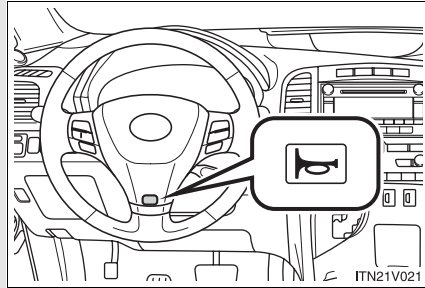

To sound the horn, press on or close to the  mark.

2

When driving

n **After adjusting the steering wheel**

Make sure that the steering wheel is securely locked.
The horn may not sound if the steering wheel is not securely locked.
(→P. 79)

2-2. Instrument cluster Gauges and meters

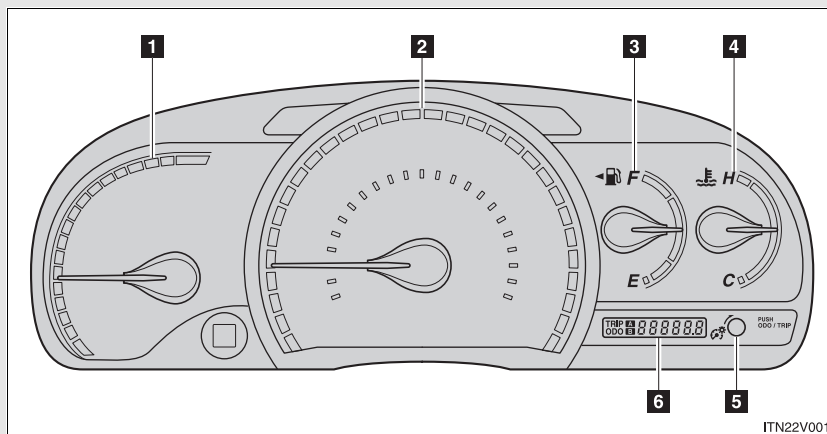

- ▶ **Vehicles with smart key system**
The following gauges, meters and display illuminate when the “ENGINE START STOP” switch is in IGNITION ON mode.
 - ▶ **Vehicles without smart key system**
The following gauges, meters and displays illuminate when the engine switch is in the “ON” position.
- 1 Tachometer**
Displays the engine speed in revolutions per minute.
 - 2 Speedometer**
Displays the vehicle speed.
 - 3 Fuel gauge**
Displays the quantity of fuel remaining in the tank.
 - 4 Engine coolant temperature gauge**
Displays the engine coolant temperature.

2-2. Instrument cluster

5 Odometer/trip meter and trip meter reset button

Switches between odometer and trip meter displays. Pushing and holding the button will reset the trip meter when the trip meter is being displayed.

6 Odometer and trip meter

Odometer: Displays the total distance the vehicle has been driven.

Trip meter: Displays the distance the vehicle has been driven since the meter was last reset. Trip meters A and B can be used to record and display different distances independently.

2

When driving

Instrument panel light control

The brightness of the instrument panel lights can be adjusted.

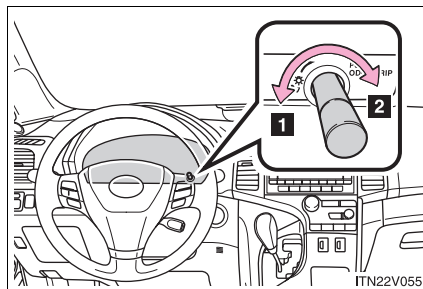

1 Darker

2 Brighter

2-2. Instrument cluster

NOTICE

n To prevent damage to the engine and its components

- I** Do not let the indicator needle of the tachometer enter the red zone, which indicates the maximum engine speed.
- I** The engine may be overheating if the engine coolant temperature gauge is in the red zone ("H"). In this case, immediately stop the vehicle in a safe place, and check the engine after it has cooled completely. (→P. 600)

2-2. Instrument cluster Indicators and warning lights

The indicator and warning lights on the instrument cluster and center panel inform the driver of the status of the vehicle's various systems.

► Instrument cluster

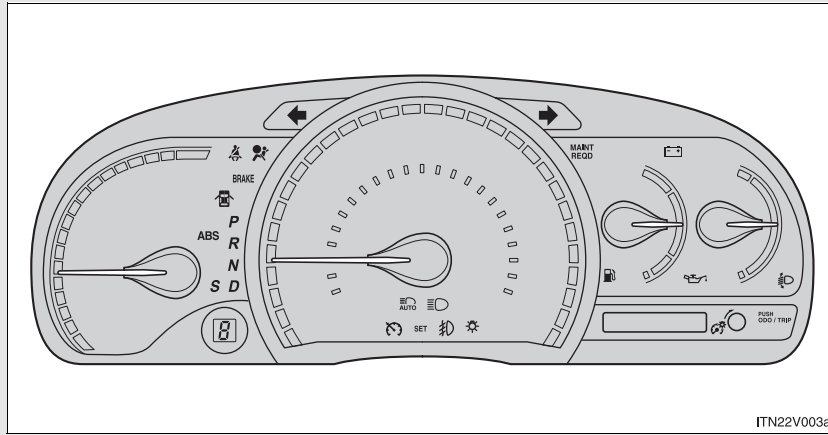

► Center display

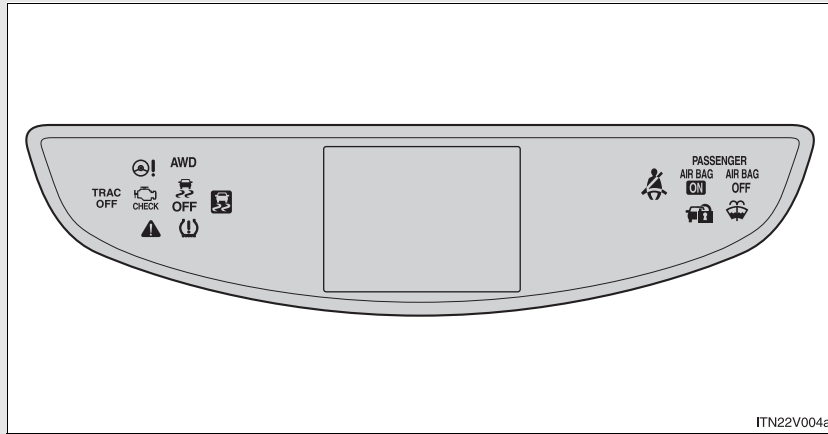

















2

When driving

2-2. Instrument cluster

n Indicators

The indicators inform the driver of the operating state of the vehicle's various systems.

	Turn signal indicator (→P. 171)		Cruise control "SET" indicator (→P. 213)
	Headlight high beam indicator (→P. 199)	^{*1, 2} 	Slip indicator (→P. 225)
	Headlight indicator (→P. 198) (U.S.A.)	^{*1} 	VSC OFF indicator (→P. 226)
	Tail light indicator (→P. 198) (Canada)		TRAC OFF indicator (→P. 226)
	Automatic High Beam indicator (→P. 202) (if equipped)	^{*1} 	"AIR BAG ON/OFF" indicator (→P. 121)
	Fog light indicator (→P. 209) (if equipped)		Shift position and shift range indicators (→P. 166)
	Security indicator (→P. 97, 100)		
	Cruise control indicator (→P. 213)		
			

n Warning lights

Warning lights inform the driver of malfunctions in the indicated vehicle's systems. (→P. 560)

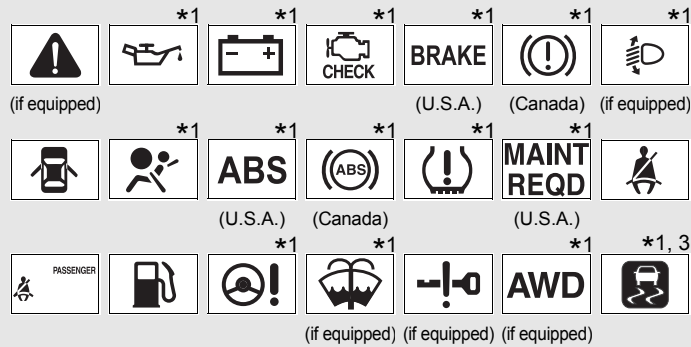

*1: These lights turn on when the "ENGINE START STOP" switch is turned to IGNITION ON mode (vehicles with smart key system) or the engine switch is turned to the "ON" position (vehicles without smart key system) to indicate that a system check is being performed. They will turn off after the engine is started, or after a few seconds. There may be a malfunction in a system if the lights do not come on, or if the lights do not turn off. Have the vehicle inspected by your Toyota dealer.

*2: The indicator flashes to indicate that the system is operating.

*3: The indicator comes on to indicate a malfunction.

! CAUTION

n If a safety system warning light does not come on

Should a safety system light such as the ABS and the SRS airbag warning lights not come on when you start the engine, this could mean that these systems are not available to help protect you in an accident, which could result in death or serious injury. Have the vehicle inspected by your Toyota dealer immediately if this occurs.

2-2. Instrument cluster

Multi-information display (TFT type)

The multi-information display presents the driver with a variety of driving-related data, including the clock and current outside temperature.

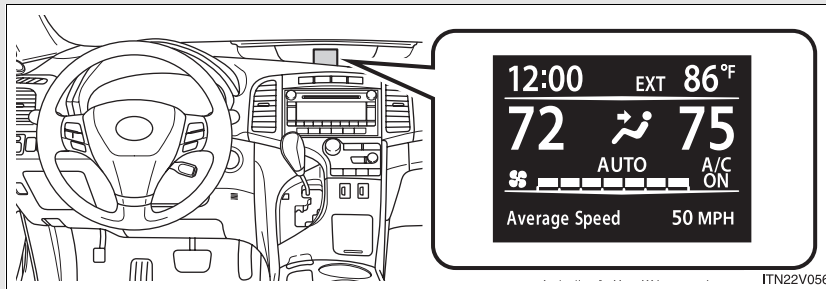

- 1 Clock (→P. 184)
Indicates and sets the time.
- 1 Outside temperature
Indicates the outside temperature.
The temperature range that can be displayed is from -40°F (-40°C) to 122°F (50°C).
- 1 Air conditioning system display (→P. 262)
Automatically displayed when the air conditioning is turned on.
- 1 Rear view monitor (vehicles without navigation system) (→P. 217)
Automatically displayed when the shift lever is moved into "R".
- 1 Trip information (→P. 181)
Displays driving range, fuel consumption and other cruising-related information.
- 1 Warning messages (→P. 575)
Automatically displayed when a malfunction occurs in one of the vehicle's systems.
- 1 Customizable features setting display (→P. 640)

Switching the display

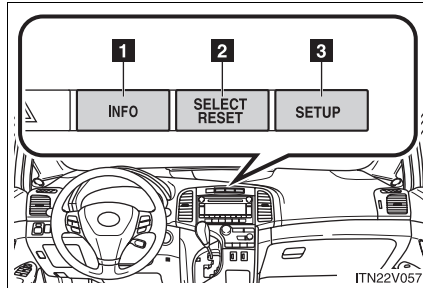

- 1 "INFO" button
- 2 "SELECT RESET" button
- 3 "SETUP" button

2

When driving

Trip information

Display items can be switched by pressing the "INFO" button.

n **Average Fuel Economy**

Displays the average fuel consumption since the function was reset.

The function can be reset by pressing and holding the "SELECT RESET" button when the average fuel economy is displayed.

n **Current Fuel Economy**

Displays the current rate of fuel consumption.

n **Distance to Empty**

Displays the estimated maximum distance that can be driven with the quantity of fuel remaining.

1 This distance is computed based on your average fuel consumption. As a result, the actual distance that can be driven may differ from that displayed.

1 When only a small amount of fuel is added to the tank, the display may not be updated.

2-2. Instrument cluster

n **Average Speed**

Displays the average vehicle speed since the engine was started or since the function was reset.

The function can be reset by pressing and holding the “SELECT RESET” button when the average speed is displayed.

n **Trip Timer**

Displays the elapsed time since the timer was reset.

The timer only functions when the engine is running. The timer can be started and paused by pressing the “SELECT RESET” button, and reset by pressing and holding the “SELECT RESET” button when the trip timer is displayed.

The display layout may be customized to show 1 line of trip information in the normal font size, 2 lines in the normal font size, or 1 line in a larger font size. (→P. 185)

When 2 lines of trip information are displayed, it is possible for both of them to be reset.

STEP 1 Press the “SELECT RESET” button.

The first display item that may be reset will be highlighted yellow.

STEP 2 Press the “SELECT RESET” button to select or reset each display item as described above.

STEP 3 Press the “SETUP” button to change which display items to reset by highlighting it in yellow.

This function only applies if both lines can be adjusted.

STEP 4 Press the “INFO” button to exit the adjusting mode.

Press the “INFO” button a second time to switch the display items.

Setting up the displays

STEP 1 Press the “SETUP” button while the vehicle is stopped.

The “Custom Settings” screen is displayed on the multi-information display.

If left idle for approximately 10 seconds, the display will revert to the previous screen.

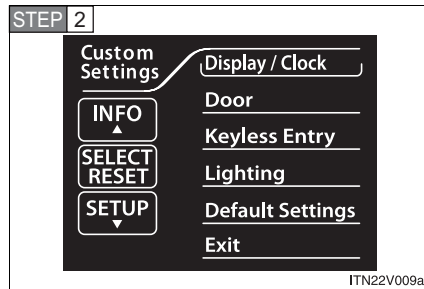

Select “Display / Clock” by pressing the “INFO” or “SETUP” button, and press the “SELECT RESET” button.

If you select “Exit” and press “SELECT RESET”, the display will revert to the previous screen.

2

When driving

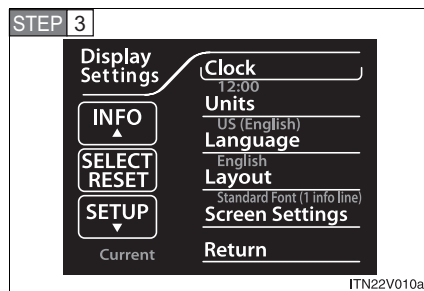

Select the desired item by pressing the “INFO” or “SETUP” button.

Press the “SELECT RESET” button to enter the setting mode.

The current setting is indicated by yellow text.

2-2. Instrument cluster

n Setting the clock

STEP 1 Select "Clock" on the "Display Settings" screen, and press the "SELECT RESET" button.

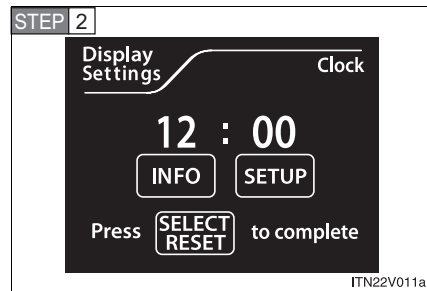

Press the "INFO" button to adjust the hours and the "SETUP" button to adjust the minutes.

Press and hold the buttons to adjust the time more quickly.

Press the "SELECT RESET" button to set the clock.

n Selecting the units

STEP 1 Select "Units" on the "Display Settings" screen, and press the "SELECT RESET" button.

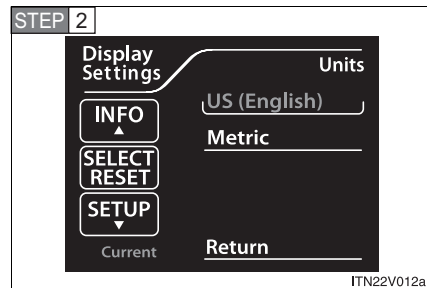

Select the units you want to read by pressing the "INFO" or "SETUP" button.

Press the "SELECT RESET" button to set the units.

The current setting is indicated by yellow text.

2-2. Instrument cluster

n Selecting the language

STEP 1 Select “Language” on the “Display Settings” screen, and press the “SELECT RESET” button.

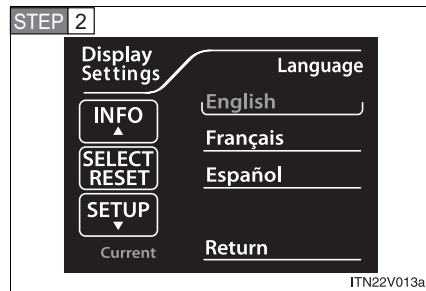

Select the language you want to read by pressing the “INFO” or “SETUP” button.

Press the “SELECT RESET” button to set the language.

The current setting is indicated by yellow text.

To shortcut directly to the “Language” screen from the initial “Custom Settings” screen, press and hold the “SETUP” button for 5 seconds.

2

When driving

n Selecting the trip information layout

STEP 1 Select “Layout” on the “Display Settings” screen, and press the “SELECT RESET” button.

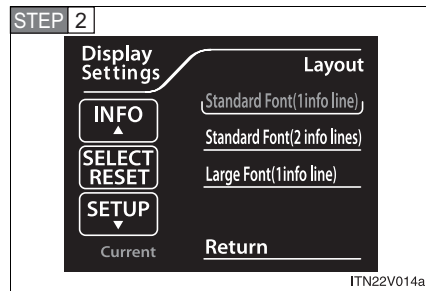

Select the desired layout by pressing the “INFO” or “SETUP” button, and press the “SELECT RESET” button.

The current setting is indicated by yellow text.

2-2. Instrument cluster

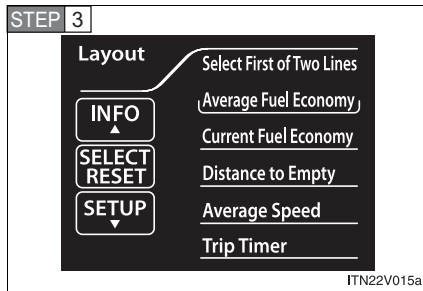

When a 2-line layout is selected in **STEP 2**, the “Layout” screen is displayed. First, using the “INFO” and “SETUP” buttons, select the item you wish to display in the first line, and then press the “SELECT RESET” button.

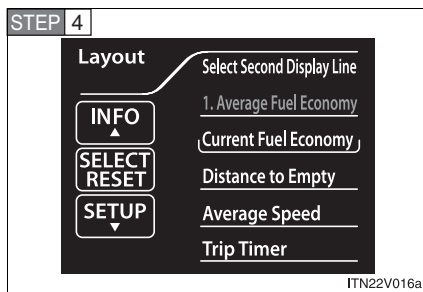

Using the “INFO” and “SETUP” buttons, select the item you wish to display in the second line, and then press the “SELECT RESET” button.

“Selection Complete” will be displayed.

n Setting up the information display

STEP 1 Select “Screen Settings” on the “Display Settings” screen, and press the “SELECT RESET” button.

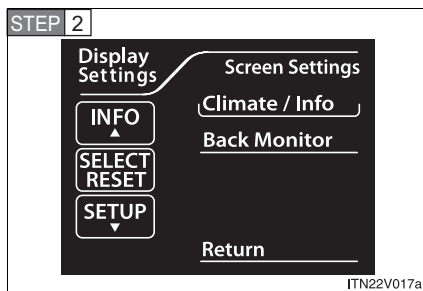

For vehicles without navigation system, select “Climate / Info” by pressing the “INFO” or “SETUP” button.

Press the “SELECT RESET” button to enter the adjustment mode.

2-2. Instrument cluster

1 Setting the brightness

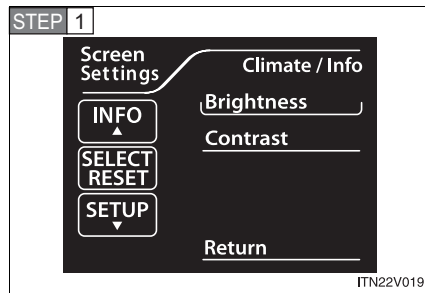

Select "Brightness" on the "Screen Settings" screen, and press the "SELECT RESET" button.

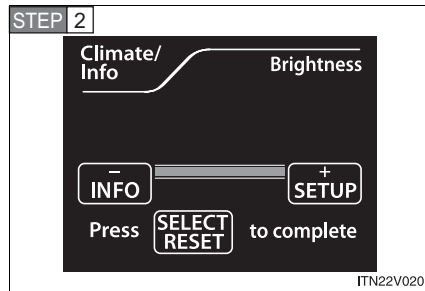

Press the "INFO" or "SETUP" button to adjust the brightness.

- + : Brighter
- : Darker

Press the "SELECT RESET" button to exit screen.

2

When driving

1 Setting the contrast

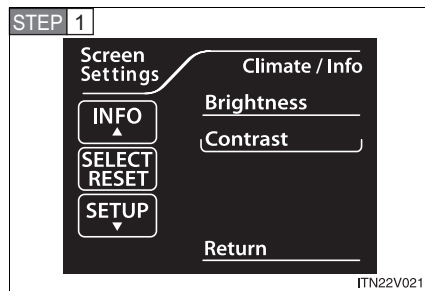

Select "Contrast" on the "Screen Settings" screen, and press the "SELECT RESET" button.

2-2. Instrument cluster

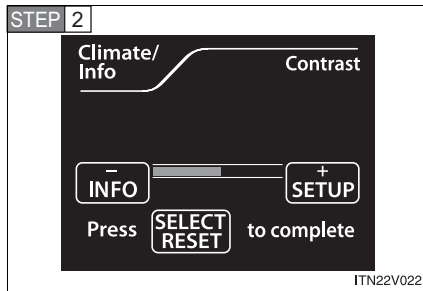

Press the "INFO" or "SETUP" button to adjust the contrast.

+: Strengthen

-: Weaken

Press the "SELECT RESET" button to exit screen.

n Setting up the rear view monitor display (vehicles without navigation system)

STEP 1 Select "Screen Settings" on the "Display Settings" screen, and press the "SELECT RESET" button.

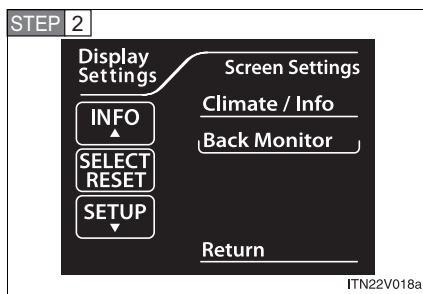

Select "Back Monitor" by pressing the "INFO" or "SETUP" button.

Press the "SELECT RESET" button to enter the adjustment mode.

2-2. Instrument cluster

1 Setting the brightness

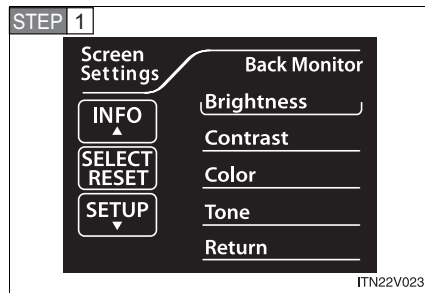

Select "Brightness" on the "Screen Settings" screen, and press the "SELECT RESET" button.

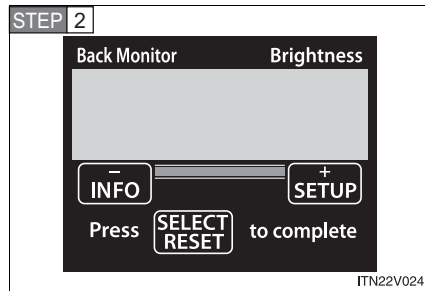

Press the "INFO" or "SETUP" button to adjust the brightness.

- + : Brighter
- : Darker

Press the "SELECT RESET" button to exit screen.

2

When driving

1 Setting the contrast

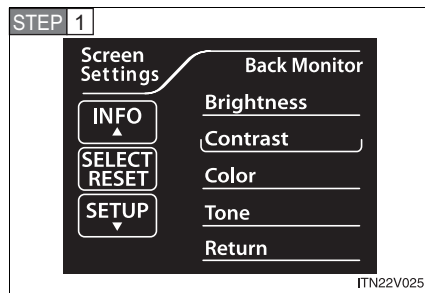

Select "Contrast" on the "Screen Settings" screen, and press the "SELECT RESET" button.

2-2. Instrument cluster

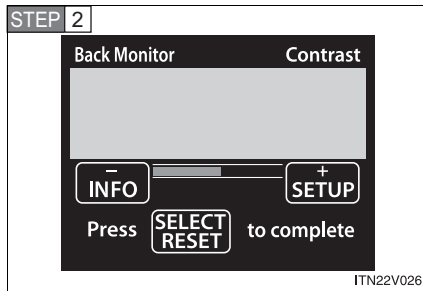

Press the “INFO” or “SETUP” button to adjust the contrast.

+: Strengthen

-: Weaken

Press the “SELECT RESET” button to exit screen.

1 Setting the color

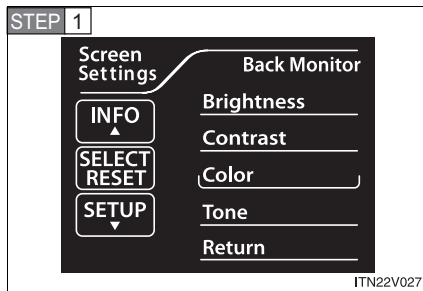

Select “Color” on the “Screen Settings” screen, and press the “SELECT RESET” button.

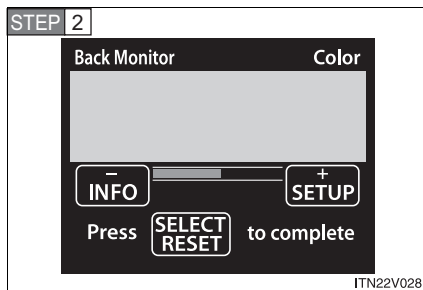

Press the “INFO” or “SETUP” button to adjust the color.

+: Green

-: Red

Press the “SELECT RESET” button to exit screen.

2-2. Instrument cluster

1 Setting the tone

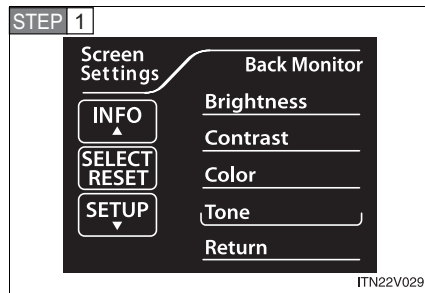

Select "Tone" on the "Screen Settings" screen, and press the "SELECT RESET" button.

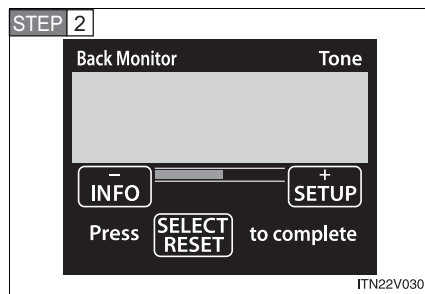

Press the "INFO" or "SETUP" button to adjust the tone.

+: Brighter

-: Darker

Press the "SELECT RESET" button to exit screen.

2

When driving

n Returning to the previous screen

Select "Return" on the "Screen Settings" screen, and press the "SELECT RESET" button.

2-2. Instrument cluster

n If the vehicle is moved while settings are being changed on the multi-information display

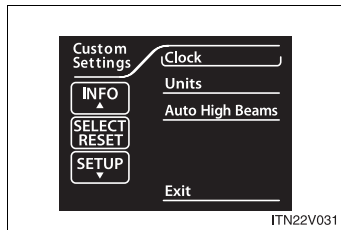

If the vehicle speed exceeds approximately 3 mph (5 km/h) while the settings are being changed, "Please Stop Vehicle to Change Settings" will be displayed on the multi-information display, and setting mode will exit after several seconds. If the "SETUP" button is pressed at a speed in excess of 3 mph (5 km/h), only some of the settings can be changed. To change the other settings, press the "SETUP" button after bringing the vehicle to a complete stop.

n System check display

► Vehicles with smart key system

After switching the "ENGINE START STOP" switch to IGNITION ON mode, "VENZA" is displayed while system operation is checked. When the system check is complete, the normal screen will return.

► Vehicles without smart key system

After switching the engine switch to the "ON" position, "VENZA" is displayed while system operation is checked. When the system check is complete, the normal screen will return.

2-2. Instrument cluster

- n **When "--", "E" or "F" is displayed on the outside temperature display**
The system may be malfunctioning. Take your vehicle to your Toyota dealer.
- n **Outside temperature display**
In the following situations, the correct outside temperature may not be displayed, or the display may take longer than normal to change.
 - l When stopped, or driving at low speeds (less than 12 mph [20 km/h])
 - l When the outside temperature has changed suddenly (at the entrance/exit of a garage, tunnel, etc.)

 NOTICE

- n **The multi-information display at low temperatures**
Allow the interior of the vehicle to warm up before using the liquid crystal information display. At extremely low temperatures, the information display monitor may respond slowly, and display changes may be delayed.

2

When driving

2-2. Instrument cluster Multi-information display (LCD type)

The multi-information display presents the driver with a variety of driving-related data, including the clock and current outside temperature.

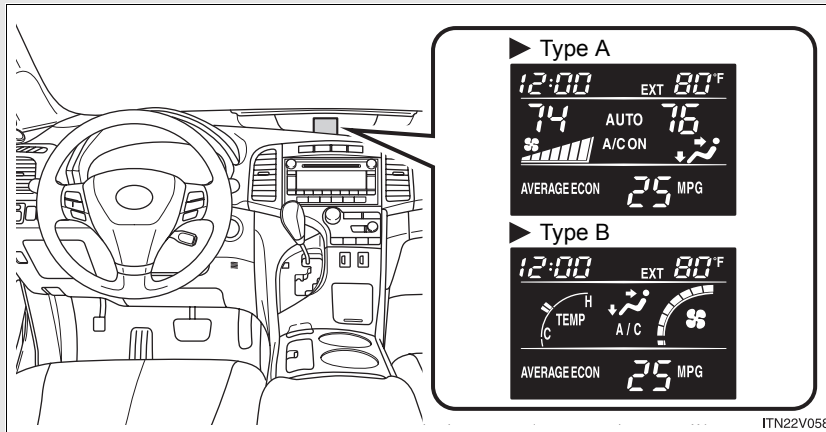

- 1 Clock (→P. 196)
Indicates and sets the time.
- 1 Outside temperature
Indicates the outside temperature.
The temperature range that can be displayed is from -40°F (-40°C) to 122°F (50°C).
- 1 Air conditioning system display (→P. 262, 272)
Automatically displayed when the air conditioning is turned on.
- 1 Trip information (→P. 195)
Displays driving range, fuel consumption and other cruising-related information.

2-2. Instrument cluster

Switching the display

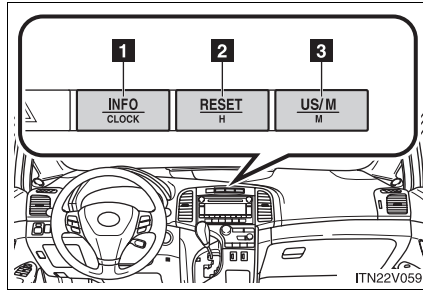

- 1 "INFO-CLOCK" button
- 2 "RESET-H" button
- 3 "US/M-M" button

2

When driving

Trip information

Display items can be switched by pressing the "INFO-CLOCK" button.

▮ **Average fuel consumption (AVERAGE ECON)**

Displays the average fuel consumption since the function was reset.

The function can be reset by pressing and holding the "RESET-H" button when the average fuel consumption is displayed.

▮ **Current fuel consumption (CURRENT ECON)**

Displays the current rate of fuel consumption.

2-2. Instrument cluster

n Driving range (RANGE)

Displays the estimated maximum distance that can be driven with the quantity of fuel remaining.

- 1 This distance is computed based on your average fuel consumption. As a result, the actual distance that can be driven may differ from that displayed.
- 1 When only a small amount of fuel is added to the tank, the display may not be updated.

n Average vehicle speed (AVERAGE SPEED)

Displays the average vehicle speed since the engine was started or since the function was reset.

The function can be reset by pressing and holding the “RESET-H” button when the average vehicle speed is displayed.

Setting the clock

- STEP 1** Press and hold the “INFO-CLOCK” button until part of the display begins to flash.
- STEP 2** Press and hold the “RESET-H” button to adjust the hours and the “US/M-M” button to adjust the minutes.
- STEP 3** Press the “INFO-CLOCK” button to complete the setting.

Selecting the units

Press the “US/M-M” button.

The unit changes each time the button is pressed.

2-2. Instrument cluster

n **Liquid crystal display**

Small spots or light spots may appear on the display. This phenomenon is characteristic of liquid crystal displays, and there is no problem to continue using the display.

n **When "--", "E" or "F" is displayed on the outside temperature display**

The system may be malfunctioning. Take your vehicle to your Toyota dealer.

n **Outside temperature display**

In the following situations, the correct outside temperature may not be displayed, or the display may take longer than normal to change.

- l When stopped, or driving at low speeds (less than 12 mph [20 km/h])
- l When the outside temperature has changed suddenly (at the entrance/exit of a garage, tunnel, etc.)

2

When driving

2-3. Operating the lights and wipers Headlight switch

The headlights can be operated manually or automatically.

Turning the end of the lever turns on the lights as follows.

► U.S.A.

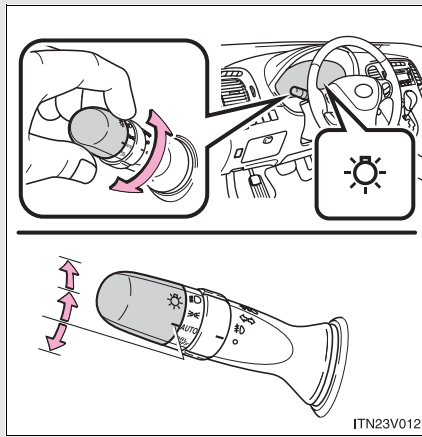



 The daytime running
(Canada only) lights turn on.

AUTO The headlights, parking lights, daytime running lights and so on turn on and off automatically.

(When the “ENGINE START STOP” switch is in IGNITION ON mode [vehicles with smart key system] or the engine switch is in the “ON” position [vehicles without smart key system].)

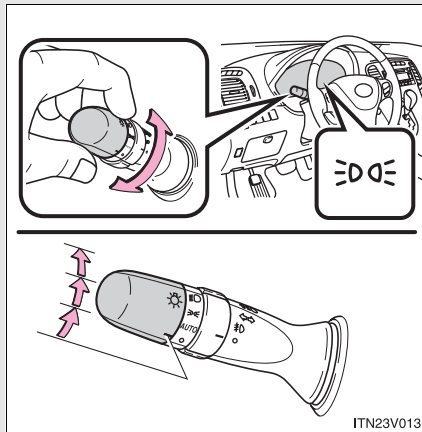
► Canada



 The side marker, parking, tail, license plate, daytime running lights and instrument panel lights turn on.

 The headlights and all lights listed above (except daytime running lights) turn on.

DRL OFF The daytime running
(U.S.A. only) lights turn off.

2-3. Operating the lights and wipers

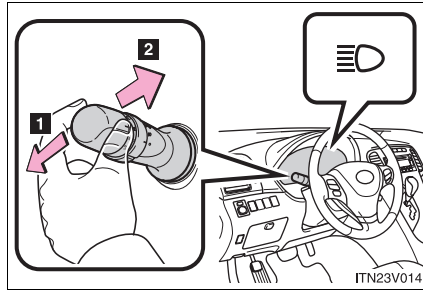
Turning on the high beam headlights

- 1 With the headlights on, push the lever forward to turn on the high beams.

Vehicles with Automatic High Beam: When the light switch is in **AUTO** position, the Automatic High Beam system will be activated. (→P. 202)

Pull the lever back to the center position to turn the high beams off.

- 2 Pull the lever toward you to turn on the high beams.

Release the lever to turn them off. You can flash the high beams with the headlights on or off.

2

When driving

n Daytime running light system

- 1 To make your vehicle more visible to other drivers, the headlights turn on automatically (at a reduced intensity) whenever the engine is started and the parking brake is released. Daytime running lights are not designed for use at night.

Vehicles for U.S.A.: Daytime running lights can be turned off by operating the switch.

- 1 Compared to turning on the headlights, the daytime running light system offers greater durability and consumes less electricity, so it can help improve fuel economy.

2-3. Operating the lights and wipers

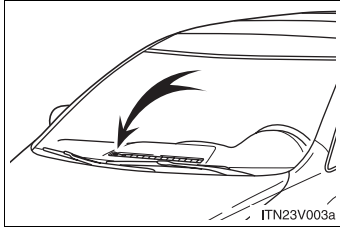
n **Headlight control sensor**



The sensor may not function properly if an object is placed on the sensor, or anything that blocks the sensor is affixed to the windshield.

Doing so interferes with the sensor detecting the level of ambient light and may cause the automatic headlight system to malfunction.

n **Automatic light off system**



▶ Vehicles with smart key system

- | When the headlights are on: The headlights and tail lights turn off 30 seconds after a door is opened and closed if the "ENGINE START STOP" switch has been switched to ACCESSORY or OFF mode.
- | When only the tail lights are on: The tail lights turn off automatically if the "ENGINE START STOP" switch is switched to ACCESSORY or OFF mode and driver's door is opened.

To turn the lights on again, turn the "ENGINE START STOP" switch to IGNITION ON mode, or turn the light switch off once and then back to the  or  position.

▶ Vehicles without smart key system

- | When the headlights are on: The headlights and tail lights turn off 30 seconds after a door is opened and closed if the engine switch has been switched to "ACC" or "LOCK" position.
- | When only the tail lights are on: The tail lights turn off automatically if the engine switch is switched to "ACC" or "LOCK" position and driver's door is opened.

To turn the lights on again, turn the engine switch to the "ON" position, or turn the light switch off once and then back to the  or  position.

2-3. Operating the lights and wipers

n **Automatic headlight leveling system (Vehicles with discharge headlights)**

The level of the headlights is automatically adjusted according to the number of passengers and the loading condition of the vehicle to ensure that the headlights do not interfere with other road users.

n **If the indicator flashes... (Vehicles with discharge headlights)**

It may indicate a malfunction in the system. Contact your Toyota dealer.

n **Customization that can be configured at Toyota dealer or by the TFT type multi-information display**

Settings (e.g. light sensor sensitivity) can be changed.
(Customizable features →P. 640)

2

When driving

NOTICE

n **To prevent battery discharge**

Do not leave the lights on longer than necessary when the engine is not running.

2-3. Operating the lights and wipers

Automatic High Beam (vehicles with discharge headlights)

The Automatic High Beam uses an in-vehicle camera sensor to assess the brightness of streetlights, the lights of oncoming and preceding vehicles, etc., and automatically turns high beam on or off as necessary.

■ Activating the Automatic High Beam system

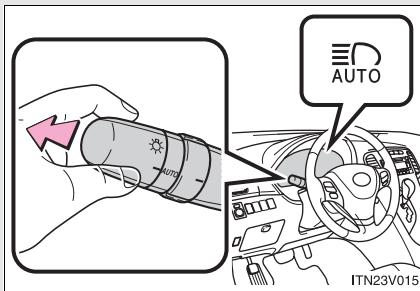

Push the lever away from you with the headlight switch in **AUTO** position when the "ENGINE START STOP" switch is in IGNITION ON mode (vehicles with smart key system) or the engine switch is in the "ON" position (vehicles without smart key system).

The Automatic High Beam indicator will come on when the headlights are turned on automatically to indicate that the system is active.

2-3. Operating the lights and wipers

n Turning the high beam on/off manually

► Switching to low beam

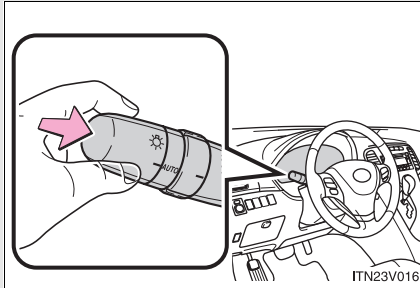

Pull the lever to original position.

► Switching to high beam

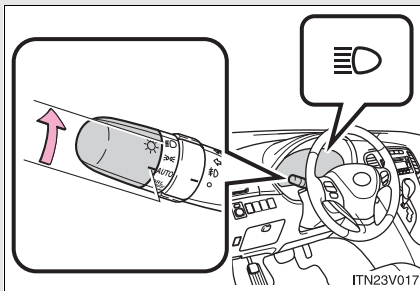

Turn the light switch to  position.

2

When driving

2-3. Operating the lights and wipers

n High beam automatic turning on or off conditions

When all of the following conditions are fulfilled, high beam will be automatically turned on (after approximately 1 second):

- 1 Vehicle speed is above approximately 20 mph (32 km/h).
- 1 The area ahead of the vehicle is dark.
- 1 There are no oncoming or preceding vehicles with headlights or tail lights turned on.

If any of the following conditions are fulfilled, high beam will be automatically turned off:

- 1 Vehicle speed drops below approximately 20 mph (32 km/h).
- 1 The area ahead of the vehicle is not dark.
- 1 Oncoming or preceding vehicles have headlights or tail lights turned on.

2-3. Operating the lights and wipers

n **Limitations of the Automatic High Beam**

Do not rely on the Automatic High Beam. Always drive safely, taking care to observe your surroundings and turning high beam on or off manually if necessary.

n **Camera sensor detection information**

1 High beam may not be automatically turned off in the following situations:

- When oncoming vehicles suddenly appear from a curve.
- When the vehicle is cut in front of by another.

1 High beam may be turned off if an oncoming vehicle that is using fog lights without using the headlights is detected.

1 Houselights, streetlights, red traffic signals, and illuminated billboards or signs may cause the high beam to turn off.

1 The following factors may affect the amount of time taken to turn high beam on or off:

- The brightness of headlights, fog lights, and tail lights of oncoming and preceding vehicles
- Road conditions (wetness, ice, snow etc.)
- The number of passengers and amount of baggage

1 High beam may be turned on or off when unexpected by the driver.

2

When driving

2-3. Operating the lights and wipers

1 In the situations below, the system may not be able to correctly detect the surrounding brightness levels, and may flash or expose nearby pedestrians to the high beam. Therefore, you should consider turning the high beam on or off manually rather than relying on the Automatic High Beam system.

- In bad weather (rain, snow, fog, sandstorms etc.)
- The windshield is obscured by fog, mist, ice, dirt etc.
- The windshield is cracked or damaged.
- The inside rear view mirror or camera sensor is deformed or dirty.
- Surrounding brightness levels are equal to those of headlights, tail lights or fog lights.
- Vehicles ahead have headlights that are either switched off, dirty, are changing color, or are not aimed properly.
- When driving through an area of intermittently changing brightness and darkness
- When frequently and repeatedly driving ascending/descending roads, or roads with rough, bumpy or uneven surfaces (such as stone-paved roads, gravel tracks etc.)
- When frequently and repeatedly taking curves or driving on a winding road
- There is a highly reflective object ahead of the vehicle, such as a sign or a mirror.
- The vehicle's headlights are damaged or dirty.
- The vehicle is listing or tilting, due to a flat tire, a trailer being towed etc.
- The Automatic High Beam indicator is flashing.
- The high beam and low beam are repeatedly being switched between in an abnormal manner.
- The driver believes that the high beam may be causing problems or distress to other drivers or pedestrians nearby.

2-3. Operating the lights and wipers

n **If the Automatic High Beam indicator flashes...**

It may indicate a malfunction in the system. Contact your Toyota dealer.

n **Customization that can be configured at Toyota dealer or by the TFT type multi-information display**

The Automatic High Beam can be turned off.
(Customizable features →P. 640)

n **Temporary lowering sensor sensitivity**

The sensitivity of the sensor can be temporarily lowered.

To lower the sensitivity, push and hold the "AUTO" button on the inside rear view mirror for 15 to 20 seconds, and release. The indicator light on the inside rear view mirror will flash to indicate that the sensitivity has been lowered.

Vehicles with smart key system:

When the "ENGINE START STOP" switch is turned off, the sensitivity will be returned to its normal level.

Vehicles without smart key system:

When the engine switch is turned to the "LOCK" position, the sensitivity will be returned to its normal level.

2

When driving

2-3. Operating the lights and wipers

NOTICE

n Camera sensor

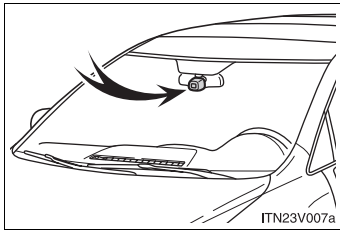

Observe the following to ensure that the Automatic High Beam functions correctly.

- I** Do not touch the camera sensor.
- I** Do not subject the inside rear view mirror or the camera sensor to a strong impact.
- I** Do not disassemble the camera sensor.
- I** Do not spill liquid onto the inside rear view mirror or the camera sensor.
- I** Do not apply window tinting or stickers to the camera sensor or the area of windshield near the camera sensor.
- I** Do not place items on the dashboard. There is a possibility that the camera sensor will mistake items reflected in the windshield for streetlights, the headlights of other vehicles, etc.
- I** Do not install a parking tag or any other accessories near or around the inside rear view mirror and the camera sensor.
- I** Do not overload the vehicle.
- I** Do not modify the vehicle.
- I** Do not replace windshield with a non-genuine windshield. Contact your Toyota dealer.

2-3. Operating the lights and wipers

Fog light switch*

The fog lights improve visibility in difficult driving conditions, such as in rain or fog. The fog lights can be used when the headlights are on low beam.

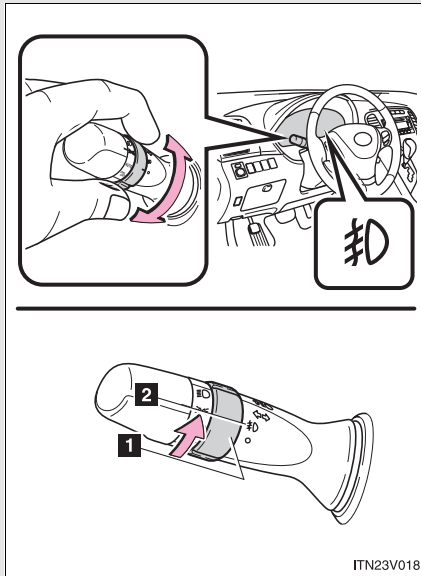

- 1** Off
- 2** On

2

When driving

*: If equipped

2-3. Operating the lights and wipers Windshield wipers and washer

Wiper intervals can be adjusted for intermittent operation (when



is selected).

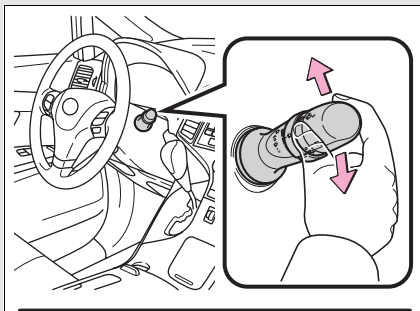

- 1 Intermittent wiper operation
- 2 Low speed wiper operation
- 3 High speed wiper operation
- 4 Temporary operation

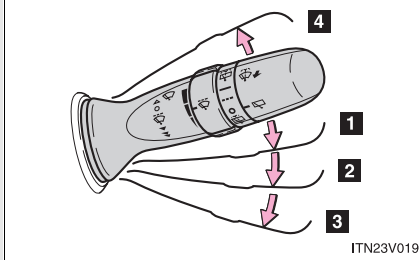

ITN23V019

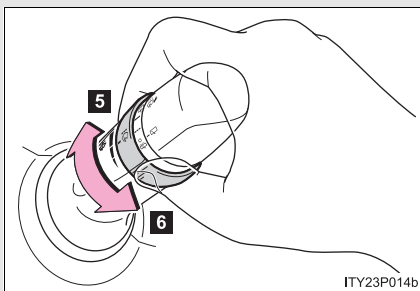

- 5 Increases the intermittent windshield wiper frequency
- 6 Decreases the intermittent windshield wiper frequency

ITY23P014b

2-3. Operating the lights and wipers

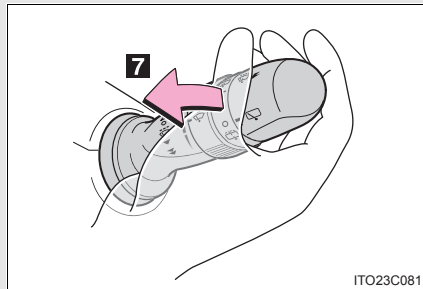

7 Wash/wipe operation

Wipers operate automatically.

2

When driving

n The windshield wiper and washer can be operated when

- ▶ Vehicles with smart key system
The “ENGINE START STOP” switch is in IGNITION ON mode.
- ▶ Vehicles without smart key system
The engine switch is in the “ON” position.

n If no windshield washer fluid sprays

Check that the washer nozzles are not blocked if there is washer fluid in the windshield washer fluid reservoir.

⚠ NOTICE

n When the windshield is dry

Do not use the wipers, as they may damage the windshield.

n When there is no washer fluid spray from the nozzle

Damage to the washer fluid pump may be caused if the lever is pulled toward you and held continually.

n When a nozzle becomes blocked

Do not try to clear it with a pin or other object. The nozzle will be damaged.

2-3. Operating the lights and wipers

Rear window wiper and washer

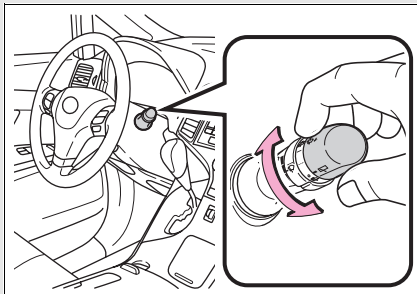

- 1 Intermittent window wiper operation
- 2 Normal window wiper operation
- 3 Washer operation
- 4 Washer/wiper dual operation

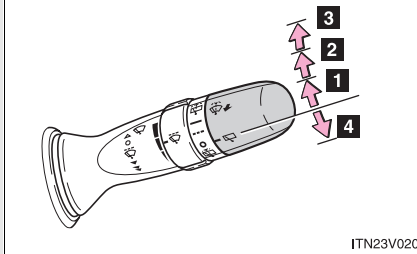

ITN23V020

n The rear window wiper and washer can be operated when

- ▶ Vehicles with smart key system
The “ENGINE START STOP” switch is in IGNITION ON mode.
- ▶ Vehicles without smart key system
The engine switch is in the “ON” position.

⚠ NOTICE

n When the rear window is dry

Do not use the wipers, as they may damage the rear window.

2-4. Using other driving systems

Cruise control

Use the cruise control to maintain a set speed without depressing the accelerator pedal.

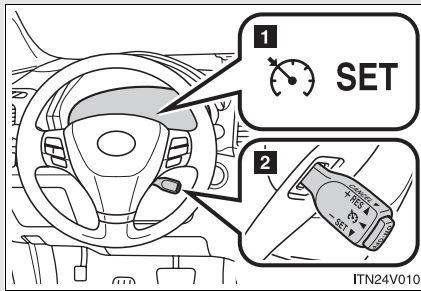

- 1 Indicators
- 2 Cruise control switch

1 Set the vehicle speed

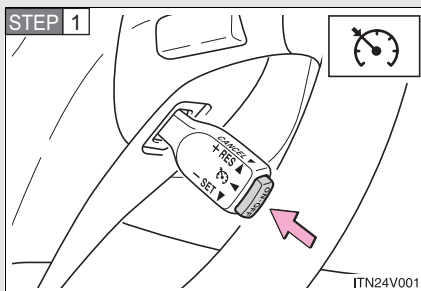

Press the "ON-OFF" button to activate the cruise control.

Press the button again to deactivate the cruise control.

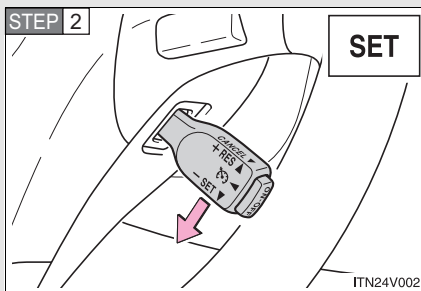

Accelerate or decelerate the vehicle to the desired speed, and push the lever down to set the speed.

Cruise control "SET" indicator will come on.

2

When driving

2-4. Using other driving systems

n **Adjusting the speed setting**

To change the set speed, operate the lever until the desired set speed is obtained.

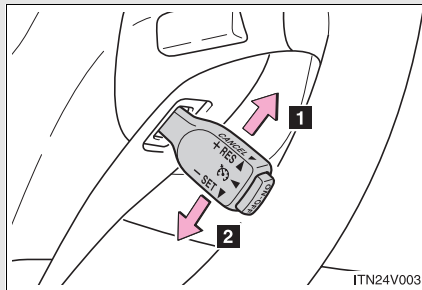

- 1** Increases speed
- 2** Decreases speed

Fine adjustment: Momentarily move the lever in the desired direction.

Large adjustment: Hold the lever in the desired direction.

The set speed will be increased or decreased as follows:

Fine adjustment: By approximately 1 mph (1.6 km/h) each time the lever is operated.

Large adjustment: The set speed can be increased or decreased continually until the lever is released.

n **Canceling and resuming the constant speed control**

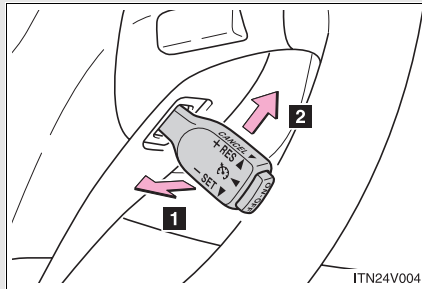

- 1** Pulling the lever toward you cancels the constant speed control.

The speed setting is also canceled when the brakes are applied.

- 2** Pushing the lever up resumes the constant speed control.

Resuming is available when the vehicle speed is more than approximately 25mph (40km/h).

2-4. Using other driving systems

n **Cruise control can be set when**

- l The shift lever is in the "D" or "4", "5" or "6" range of "S".
- l Vehicle speed is more than approximately 25 mph (40 km/h).

n **Accelerating**

The vehicle can be accelerated normally. After acceleration, the set speed resumes.

n **Automatic cruise control cancelation**

Cruise control will stop maintaining the vehicle speed in any of the following situations.

- l Actual vehicle speed falls more than approximately 10 mph (16 km/h) below the preset vehicle speed.
At this time, the memorized set speed is not retained.
- l Actual vehicle speed is below approximately 25 mph (40 km/h).
- l Enhanced VSC is activated.

n **If the cruise control indicator light flashes**

Press the "ON-OFF" button once to deactivate the system, and then press the button again to reactivate the system.

If the cruise control speed cannot be set or if the cruise control cancels immediately after being activated, there may be a malfunction in the cruise control system. Have the vehicle inspected by your Toyota dealer.

2

When driving

2-4. Using other driving systems

CAUTION

n To avoid operating the cruise control by mistake

Switch the cruise control off using the “ON-OFF” button when not in use.

n Situations unsuitable for cruise control

Do not use cruise control in any of the following situations. Doing so may result in loss of control and could cause an accident resulting in death or serious injury.

- l** In heavy traffic
- l** On roads with sharp bends
- l** On slippery roads, such as those covered with rain, ice or snow
- l** On steep hills
Vehicle speed may exceed the set speed when driving down a steep hill.
- l** On winding roads
- l** When your vehicle is towing a trailer or during emergency towing

2-4. Using other driving systems Rear view monitor system*

The rear view monitor system assists the driver by displaying an image of the view behind the vehicle while reversing. The image is displayed in reverse on the screen. This allows the image to appear in the same manner as that of the rear view mirror.

► With navigation system

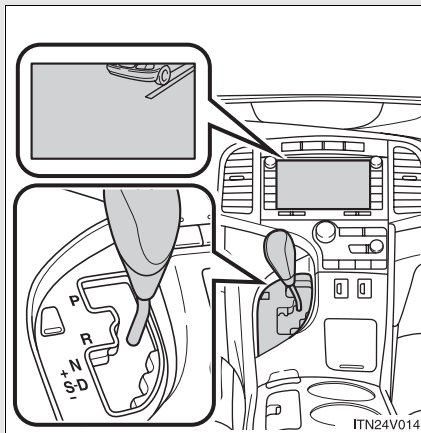

Rear view image is displayed when the shift lever is in “R”.

If you move the lever out of “R”, the screen returns to the previous one.

► Without navigation system

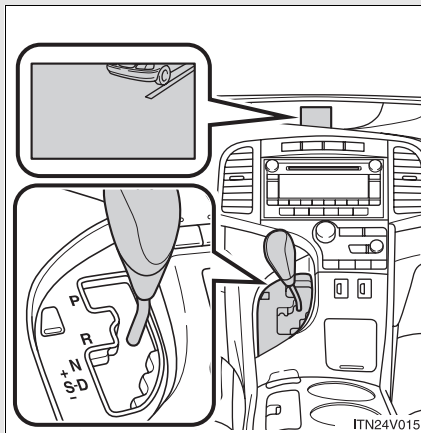

2

When driving

*: If equipped

2-4. Using other driving systems

n Displayed area

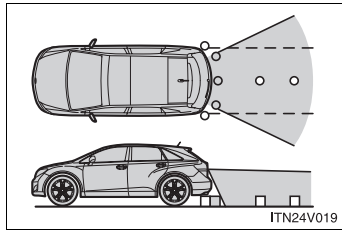

The area covered by the camera is limited. Objects which are close to either corner of the bumper or under the bumper cannot be seen on the screen.

The area displayed on the screen may vary according to vehicle orientation or road conditions.

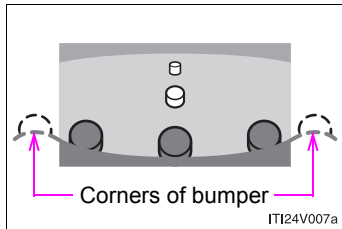

2-4. Using other driving systems

n Rear view monitor system camera

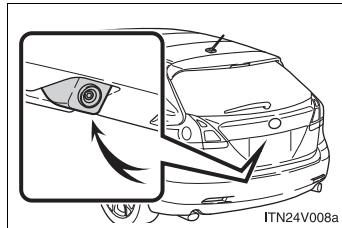

In the following cases, it may be difficult to see the images on the screen, even when the system is functioning correctly.

- In the dark (e.g. at night).
- If the temperature near the lens is extremely high or low.
- If water droplets get on the camera, or when humidity is high (e.g. when it rains).
- If foreign matter (e.g. snow or mud) get on the camera lens.
- If the sun or headlights are shining directly into the camera lens.
- When the camera has scratches or dirt on it.

2

When driving

n Smear effect

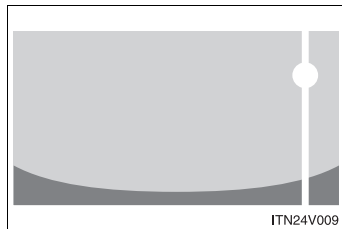

If a bright light (for example, sunlight reflected off the vehicle body) is picked up by the camera, a smear effect* peculiar to the camera may occur.

*: Smear effect—A phenomenon that occurs when a bright light (for example, sunlight reflected off the vehicle body) is picked up by the camera; when transmitted by the camera, the light source appears to have a vertical streak above and below it.

n Flicker effect

When the camera is used under fluorescent lights, sodium lights, or mercury lights etc., the lights and the illuminated areas may appear to flicker.

2-4. Using other driving systems

n **Setting the rear view monitor system displays**

- ▶ Vehicles with navigation system
→ "Navigation System Owner's Manual"
- ▶ Vehicles without navigation system
→ P. 188

CAUTION

n **When using the rear view monitor system, observe these precautions to avoid an accident that could result in death or serious injuries.**

- ! Never depend solely on the monitor system when reversing.
- ! Always check visually and with the mirrors to confirm your intended path is clear.
- ! Depicted distances between objects and flat surfaces differ from actual distances.
- ! Do not use the system if the back door is not completely closed.
- ! Do not use the system when using tire chains or the compact spare tire.

2-4. Using other driving systems

 CAUTION**n Conditions which may affect the rear view monitor system**

- I** If the back of the vehicle is hit, the camera's position and mounting angle may change. Contact your Toyota dealer.
- I** Rapid temperature changes, such as when hot water is poured on the vehicle in cold weather, may cause the system to function abnormally.
- I** If the camera lens is dirty, it cannot transmit a clear image. Rinse with water and wipe with a soft cloth. If extremely dirty, wash with a mild cleanser and rinse.
- I** The displayed image may be darker and moving images may be slightly distorted when the system is cold.
- I** If the tires are changed, the area displayed on the screen may be incorrect. When changing the tires, consult your Toyota dealer.
- I** Do not subject the rear view monitor system camera to a strong impact or force, and do not disassemble the rear view monitor system camera.
- I** If you scrape the camera lens, or scrub it with a hard brush or an abrasive agent, you may scratch the lens, leading to poor picture quality.
- I** When washing the vehicle, do not apply intensive bursts of water to the camera or camera area. Doing so may result in the camera malfunctioning.
- I** Do not allow organic solvent, car wax, window cleaner or glass coat to adhere to the camera. If this happens, wipe it off as soon as possible.
- I** As the camera has a water proof construction, do not detach, disassemble or modify it. This may cause incorrect operation.

2

When driving

2-4. Using other driving systems

Hill-start assist control

Hill-start assist control helps to prevent the vehicle from rolling backwards when starting on incline or slippery slope.

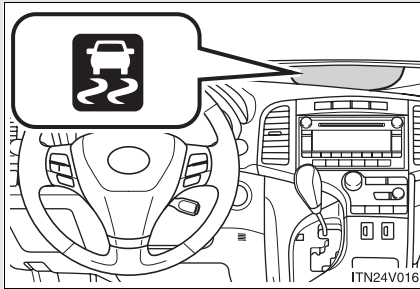

To engage hill-start assist control, further depress the brake pedal when the vehicle is stopped completely.

A buzzer will sound once to indicate the system is activated. The slip indicator will also start flashing.

n Hill-start assist control operating conditions

The system operates in the following situations:

- The shift lever is in a position other than "P".
- The parking brake is not applied.
- The accelerator pedal is not depressed.

n Hill-start assist control

- 1 While hill-start assist control is operating, the brakes remain automatically applied after the driver releases the brake pedal. The stop lights and the high mounted stoplight turn on.
- 1 Hill-start assist control operates for about 2 seconds after the brake pedal is released.
- 1 If the slip indicator does not flash and the buzzer does not sound when the brake pedal is further depressed, slightly reduce the pressure on the brake pedal (do not allow the vehicle to roll backward) and then firmly depress it again. If the system still does not operate, check that the operating conditions explained above have been met.

2-4. Using other driving systems

n Hill-start assist control buzzer

- l When hill-start assist control is activated, the buzzer will sound once.
- l In the following situations, hill-start assist control will be canceled and the buzzer will sound twice.
 - No attempt is made to drive the vehicle within approximately 2 seconds of releasing the brake pedal.
 - The shift lever is moved to "P".
 - The parking brake is applied.
 - The brake pedal is depressed again.

n If the slip indicator comes on...

It may indicate a malfunction in the system. Contact your Toyota dealer.

2

When driving

⚠ CAUTION

n Hill-start assist control

- l Do not overly rely on hill-start assist control. Hill-start assist control may not operate effectively on extremely steep inclines or roads covered in ice.
- l Unlike the parking brake, hill-start assist control is not intended to hold the vehicle stationary for an extended period of time. Do not attempt to use hill-start assist control to hold the vehicle on an incline for an extended period of time, as doing so may lead to an accident.

2-4. Using other driving systems

Driving assist systems

To help enhance driving safety and performance, the following systems operate automatically in response to various driving situations. Be aware, however, that these systems are supplementary and should not be relied upon too heavily when operating the vehicle.

n **ABS (Anti-lock Brake System)**

Helps to prevent wheel lock when the brakes are applied suddenly, or if the brakes are applied while driving on a slippery road surface.

n **Brake assist**

Generates an increased level of braking force after the brake pedal is depressed, when the system detects a panic stop situation.

n **Enhanced VSC (Enhanced Vehicle Stability Control)**

Helps the driver to control skidding when swerving suddenly or turning on slippery road surfaces.

n **TRAC (Traction Control)**

Maintains drive power and prevent the front wheels (2WD models) or four wheels (AWD models) from spinning when starting the vehicle or accelerating on slippery roads.

n **Hill-start assist control**

→P. 222

n **EPS (Electric Power Steering)**

Employs an electric motor to reduce the amount of effort needed to turn the steering wheel.

2-4. Using other driving systems

n Active Torque Control 4WD (if equipped)

Automatically switches from front-wheel drive to AWD (All-Wheel Drive) according to driving conditions, helping to ensure reliable handling and stability. Examples of conditions where the system will switch to AWD are when cornering, going uphill, starting off or accelerating, and when the road surface is slippery due to snow or rain etc.

When the Enhanced VSC/TRAC are operating

2

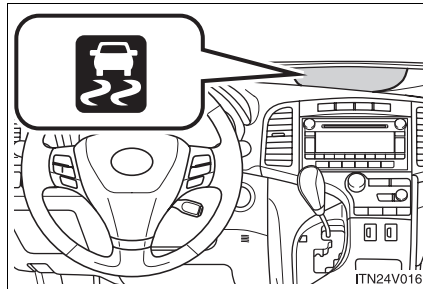

If the vehicle is in danger of slipping or if the front wheels (2WD models) or four wheels (AWD models) spin, the slip indicator light flashes to indicate that the Enhanced VSC/TRAC have been engaged.

When driving

2-4. Using other driving systems

To disable TRAC and/or Enhanced VSC

If the vehicle gets stuck in fresh snow or mud, TRAC and Enhanced VSC may reduce power from the engine to the wheels. You may need to turn the system off to enable you to rock the vehicle in order to free it.

n Turning off TRAC

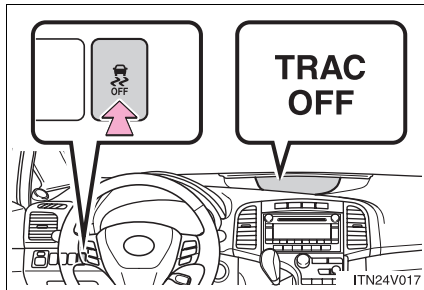

Quickly push and release the button to turn off TRAC.

The TRAC OFF indicator light should come on.

Push the button again to turn the system back on.

n Turning off TRAC and Enhanced VSC

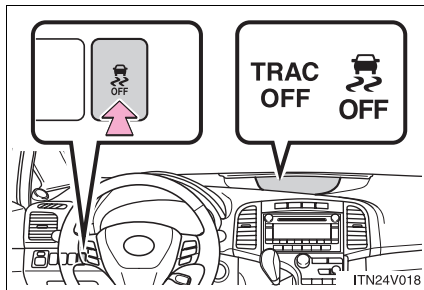

Push and hold the button for more than 3 seconds while the vehicle is stopped to turn off TRAC and Enhanced VSC.

The TRAC OFF indicator light and Enhanced VSC OFF indicator light will come on.

Push the button again to turn the system back on.

2-4. Using other driving systems

n Automatic reactivation of TRAC and Enhanced VSC**► Vehicles with smart key system**

Turning the “ENGINE START STOP” switch off after turning off the TRAC and Enhanced VSC will automatically re-enable them.

► Vehicles without smart key system

Turning the engine switch to the “LOCK” position after turning off the TRAC and Enhanced VSC will automatically re-enable them.

n Automatic TRAC reactivation

If only the TRAC is turned off, the TRAC will turn on when vehicle speed increases.

n Automatic TRAC and Enhanced VSC reactivation

If the TRAC and Enhanced VSC are turned off, the systems will not turn on even when vehicle speed increases.

n Sounds and vibrations caused by the ABS, brake assist, TRAC and Enhanced VSC

1 A sound may be heard from the engine compartment when the engine is started or just after the vehicle begins to move. This sound does not indicate that a malfunction has occurred in any of these systems.

1 Any of the following conditions may occur when the above systems are operating. None of these indicates that a malfunction has occurred.

- Vibrations may be felt through the vehicle body and steering.
- A motor sound may be heard after the vehicle comes to a stop.
- The brake pedal may pulsate slightly after the ABS is activated.
- The brake pedal may move down slightly after the ABS is activated.

2

When driving

2-4. Using other driving systems

n **EPS operation sound**

When the steering wheel operates, a motor sound (whirring sound) may be heard.

This does not indicate a malfunction.

n **Reduced effectiveness of EPS**

The effectiveness of EPS is reduced to prevent the system from overheating when there is frequent steering input over an extended period of time. The steering wheel may feel heavy as a result. Should this occur, refrain from excessive steering input or stop the vehicle and turn the engine off. The system should return to normal within 10 minutes.

CAUTION

n **The ABS does not operate effectively when**

- l The limits of tire gripping performance have been exceeded.
- l The vehicle hydroplanes while driving at high speed on the wet or slick road.

n **Stopping distance when the ABS is operating on the wet or slick roads**

The ABS is not designed to shorten the vehicle's stopping distance. Always maintain a safe distance from the vehicle in front of you in the following situations.

- l When driving on dirt, gravel or snow-covered roads
- l When driving with tire chains
- l When driving over bumps in the road
- l When driving over roads with potholes or roads with uneven roads

n **TRAC may not operate effectively when**

Directional control and power may not be achievable while driving on slippery road surfaces, even if the TRAC is operating.

Do not drive the vehicle in conditions where stability and power may be lost.

2-4. Using other driving systems

⚠ CAUTION**n When TRAC and Enhanced VSC are off**

Be especially careful and drive at a speed appropriate to the road conditions. As there are systems to ensure vehicle stability and driving force, do not turn off TRAC and Enhanced VSC unless necessary.

n When the Enhanced VSC is activated

The slip indicator light flashes. Always drive carefully. Reckless driving may cause an accident. Exercise particular care when the indicator light flashes.

n Replacing tires

Make sure that all tires are of the same size, brand, tread pattern and total load capacity. In addition, make sure that the tires are inflated to the specified tire pressure level.

The ABS and Enhanced VSC will not function correctly if different tires are fitted on the vehicle.

Contact your Toyota dealer for further information when replacing tires or wheels.

n Handling of tires and suspension

Using tires with any kind of problem or modifying the suspension will affect the driving assist systems, and may cause the system to malfunction.

n Active Torque Control 4WD system

I The AWD system of this vehicle is intended to ensure driving stability on normal roads. It is not designed for use in demanding situations such as rally driving.

I Take care when driving on slippery road surfaces.

2

When driving

2-5. Driving information

Utility vehicle precautions

This vehicle belongs to the utility vehicle class, which has higher ground clearance and narrower tread in relation to the height of its center of gravity.

Utility vehicle feature

- 1 Specific design characteristics give it a higher center of gravity than ordinary passenger cars. This vehicle design feature causes this type of vehicle to be more likely to rollover. And, utility vehicles have a significantly higher rollover rate than other types of vehicles.
- 1 It is not designed for cornering at the same speeds as ordinary passenger cars any more than low-slung sports cars are designed to perform satisfactorily under off-road conditions. Therefore, sharp turns at excessive speeds may cause rollover.

⚠ CAUTION

n Utility vehicle precautions

Always observe the following precautions to help minimize the risk of serious personal injury or damage to your vehicle:

- I** In a rollover crash, an unbelted person is significantly more likely to die than a person wearing a seat belt. Therefore, the driver and all passengers should fasten their seat belts whenever the vehicle is moving.
- I** Avoid sharp turns or abrupt maneuvers, if at all possible. Failure to operate this vehicle correctly may result in loss of control or vehicle rollover causing death or serious injury.
- I** Loading cargo on the roof luggage carrier will make the center of the vehicle gravity higher. Avoid high speeds, sudden starts, sharp turns, sudden braking or abrupt maneuvers, otherwise it may result in loss of control or vehicle rollover due to failure to operate this vehicle correctly and result in death or serious injury.
- I** Always slow down in gusty crosswinds. Because of its profile and higher center of gravity, your vehicle is more sensitive to side winds than an ordinary passenger car. Slowing down will allow you to have better control.
- I** Do not drive horizontally across steep slopes. Driving straight up or straight down is preferred. Your vehicle (or any similar off-road vehicle) can tip over sideways much more easily than forward or backward.

2

When driving

2-5. Driving information

Off-road driving

Your vehicle is not designed to be driven off-road. However, in the event that off-road driving cannot be avoided, please observe the following precautions to help avoid the areas prohibited to vehicles.

- 1 Drive your vehicle only in areas where off-road vehicles are permitted to travel.
- 1 Respect private property. Get owner's permission before entering private property.
- 1 Do not enter areas that are closed. Honor gates, barriers and signs that restrict travel.
- 1 Stay on established roads. When conditions are wet, driving techniques should be changed or travel delayed to prevent damage to roads.

n Additional information for off-road driving

- For owners in U.S. mainland, Hawaii and Puerto Rico:

To obtain additional information pertaining to driving your vehicle off-road, consult the following organizations.

- 1 State and Local Parks and Recreation Departments
- 1 State Motor Vehicle Bureau
- 1 Recreational Vehicle Clubs
- 1 U.S. Forest Service and Bureau of Land Management

 CAUTION

n Off-road driving precautions

Always observe the following precautions to help minimize the risk of serious personal injury or damage to your vehicle:

- I** Drive carefully when off the road. Do not take unnecessary risks by driving in dangerous places.
- I** Do not grip the steering wheel spokes when driving off-road. A bad bump could jerk the wheel and injure your hands. Keep both hands and especially your thumbs on the outside of the rim.
- I** Always check your brakes for effectiveness immediately after driving in sand, mud, water or snow.
- I** After driving through tall grass, mud, rock, sand, rivers, etc., check that there is no grass, bush, paper, rags, stone, sand, etc. adhering or trapped on the underbody. Clear off any such matter from the underbody. If the vehicle is used with these materials trapped or adhering to the underbody, a breakdown or fire could occur.
- I** When driving off-road or in rugged terrain, do not drive at excessive speeds, jump, make sharp turns, strike objects, etc. This may cause loss of control or vehicle rollover causing death or serious injury. You are also risking expensive damage to your vehicle's suspension and chassis.

2

When driving

2-5. Driving information

NOTICE

n To prevent the water damage

Take all necessary safety measures to ensure that water damage to the engine or other components does not occur.

- I** Water entering the engine air intake will cause severe engine damage.
- I** Water entering the automatic transmission will cause deterioration in shift quality, locking up of your transmission accompanied by vibration, and ultimately damage.
- I** Water can wash the grease from wheel bearings, causing rusting and premature failure, and may also enter the differentials, transmission and transfer case, reducing the gear oil's lubricating qualities.

n When you drive through water

If driving through water, such as when crossing shallow streams, first check the depth of the water and the bottom of the river bed for firmness. Drive slowly and avoid deep water.

n Inspection after off-road driving

- I** Sand and mud that has accumulated in brake drums and around brake discs may affect braking efficiency and may damage brake system components.
- I** Always perform a maintenance inspection after each day of off-road driving that has taken you through rough terrain, sand, mud, or water. For scheduled maintenance information, refer to the "Scheduled Maintenance Guide" or "Owner's Manual Supplement".

2-5. Driving information

Cargo and luggage

Take notice of the following information about storage precautions, cargo capacity and load.

- 1 Stow cargo and luggage in the luggage compartment whenever possible. Be sure all items are secured in place.
- 1 Be careful to keep the vehicle level. Placing the weight as far forward as possible helps maintain vehicle balance.
- 1 For better fuel economy, do not carry unnecessary weight.

2

When driving

2-5. Driving information

Capacity and distribution

Cargo capacity depends on the total weight of the occupants.

(Cargo capacity) = (Total load capacity) — (Total weight of occupants)

Steps for Determining Correct Load Limit—

- (1) Locate the statement “The combined weight of occupants and cargo should never exceed XXX kg or XXX lbs.” on your vehicle’s placard.
- (2) Determine the combined weight of the driver and passengers that will be riding in your vehicle.
- (3) Subtract the combined weight of the driver and passengers from XXX kg or XXX lbs.
- (4) The resulting figure equals the available amount of cargo and luggage load capacity.

For example, if the “XXX” amount equals 1400 lbs. and there will be five 150 lb passengers in your vehicle, the amount of available cargo and luggage load capacity is 650 lbs. (1400 - 750 (5 × 150) = 650 lbs.)

- (5) Determine the combined weight of luggage and cargo being loaded on the vehicle.

That weight may not safely exceed the available cargo and luggage load capacity calculated in Step 4.

- (6) If your vehicle will be towing a trailer, load from your trailer will be transferred to your vehicle. Consult this manual to determine how this reduces the available cargo and luggage load capacity of your vehicle. (→P. 240)

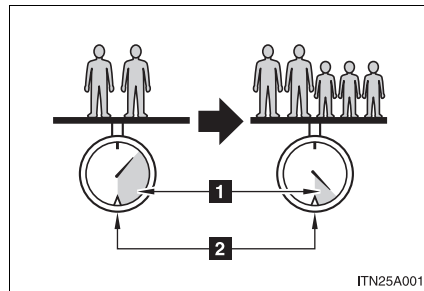
Example on your vehicle

- 1** Cargo capacity
- 2** Total load capacity

2

When driving

When 2 people with the combined weight of 366 lb. (166 kg) are riding in your vehicle, which has a total load capacity of 895 lb. (405 kg), the available amount of cargo and luggage load capacity will be as follows:

$$895 \text{ lb.} - 366 \text{ lb.} = 529 \text{ lb.} \quad (405 \text{ kg} - 166 \text{ kg} = 239 \text{ kg})$$

In this condition, if 3 more passengers with the combined weight of 388 lb. (176 kg) get on, the available cargo and luggage load will be reduced as follows:

$$529 \text{ lb.} - 388 \text{ lb.} = 141 \text{ lb.} \quad (239 \text{ kg} - 176 \text{ kg} = 63 \text{ kg})$$

As shown in the above example, if the number of occupants increases, the cargo and luggage load equaling the combined weight of the occupants who got on later, by an amount. In other words, if an increase in the number of occupants causes an excess of the total load capacity (combined weight of occupants plus cargo and luggage load), you must reduce the cargo and luggage on your vehicle.

2-5. Driving information

CAUTION

n Things that must not be carried in the luggage compartment

The following things may cause a fire if loaded in the luggage compartment.

- I** Receptacles containing gasoline
- I** Aerosol cans

n Storage precautions

Observe the following precautions.

Failing to do so may result in death or serious injury.

- I** Do not place cargo or luggage in or on the following locations as the item may get under the brake or accelerator pedal and prevent the pedals from being depressed properly, block the driver's vision, or hit the driver or passengers, causing an accident.
 - Driver's feet
 - Front passenger or rear seats (when stacking items)
 - Luggage cover (if equipped)
 - Instrument panel
 - Dashboard
 - Auxiliary box or tray that has no lid
- I** Secure all items in the occupant compartment, as they may shift and injure someone during sudden braking, sudden swerving or an accident.
- I** Never allow anyone to ride in the luggage compartment. It is not designed for passengers. They should ride in their seats with their seat belts properly fastened. Otherwise, they are much more likely to suffer death or serious injury, in the event of sudden braking, sudden swerving or an accident.

 CAUTION

n Weight of the load

- I** Do not exceed the maximum axle weight rating or the total vehicle weight rating.
- I** Even if the total load of occupant's weight and the cargo load is less than the total load capacity, do not apply the load unevenly. Improper loading may cause deterioration of steering or braking control which may cause death or serious injury.

2

When driving

2-5. Driving information

Vehicle load limits

Vehicle load limits include total load capacity, seating capacity, towing capacity and cargo capacity.

n Total load capacity: 895 lb. (405 kg)

Total load capacity means the combined weight of occupants, cargo and luggage.

n Seating capacity: 5 occupants (Front 2, Rear 3)

Seating capacity means the maximum number of occupants whose estimated average weight is 150 lb. (68 kg) per person.

Even if the number of occupants is within the seating capacity, do not exceed the total load capacity.

n Towing capacity

With towing package:

- ▶ **2GR-FE engine**
3500 lb. (1585 kg)
- ▶ **1AR-FE engine**
2500 lb. (1135 kg)

Without towing package: 1000 lb. (450 kg)

Towing capacity means the maximum gross trailer weight (trailer weight plus its cargo weight) that your vehicle is able to tow.

n Cargo capacity

Cargo capacity may increase or decrease depending on the weight and the number of occupants.

n Total load capacity and seating capacity

These details are also described on the tire and loading information label. (→P. 513)

⚠ CAUTION

n Overloading the vehicle

Do not overload the vehicle.
It may not only cause damage to the tires, but also degrade steering and braking ability, resulting in an accident.

2

When driving

2-5. Driving information

Winter driving tips

Carry out the necessary preparations and inspections before driving the vehicle in winter. Always drive the vehicle in a manner appropriate to the prevailing weather conditions.

n Pre-winter preparations

- 1 Use fluids that are appropriate to the prevailing outside temperatures.
 - Engine oil
 - Engine coolant
 - Washer fluid
- 1 Have a service technician inspect the level and specific gravity of battery electrolyte.
- 1 Have the vehicle fitted with four snow tires or purchase a set of tire chains for the front tires (do not fit tire chains on to the rear tires).

Ensure that all tires are the same size and brand, and that chains match the size of the tires.

n Before driving the vehicle

Perform the following according to the driving conditions.

- 1 Do not try to forcibly open a window or move a wiper that is frozen. Pour warm water over the frozen area to melt the ice. Wipe away the water immediately to prevent it from freezing.
- 1 To ensure proper operation of the climate control system fan, remove any snow that has accumulated on the air inlet vents in front of the windshield.
- 1 Remove any ice that has accumulated on the vehicle chassis.
- 1 Periodically check for and remove any excess ice or snow that may have accumulated in the wheel well or on the brakes.

n When driving the vehicle

Accelerate the vehicle slowly and drive at a reduced speed suitable to road conditions.

n When parking the vehicle

Park the vehicle and move the shift lever to "P" without setting the parking brake. The parking brake may freeze up, preventing it from being released. If necessary block the wheels to prevent inadvertent sliding or creeping.

2

When driving

2-5. Driving information

Selection tire chains

Use the correct tire chain size when mounting the tire chains.
Chain size is regulated for each tire size.

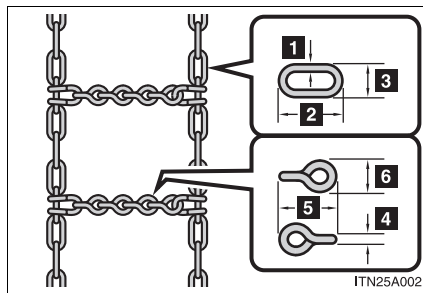

Side chain:

- 1 0.12 in. (3.0 mm)
- 2 1.18 in. (30.0 mm)
- 3 0.39 in. (10.0 mm)

Cross chain:

- 4 0.16 in. (4.0 mm)
- 5 0.98 in. (25.0 mm)
- 6 0.55 in. (14.0 mm)

Regulations on the use of tire chains

- 1 Regulations regarding the use of tire chains vary according to location and type of road. Always check local regulations before installing chains.
- 1 Retighten the chains after driving 1/4 - 1/2 mile (0.5 - 1.0 km).

n Tire chains

Observe the following precautions when installing and removing chains.

- 1 Install and remove tire chains in a safe location.
- 1 Install tire chains on the front tires only. Do not install tire chains on the rear tires.
- 1 Install tire chains following the instructions provided in the accompanying manual.

 CAUTION

n Driving with snow tires

Observe the following precautions to reduce the risk of accidents. Failing to do so may result in a loss of vehicle control and cause death or serious injury.

- I** Use tires of the size specified for your vehicle.
- I** Maintain the recommended level of tire inflation pressure.
- I** Do not drive in excess of 75 mph (120 km/h), regardless of the type of snow tires being used.
- I** Snow tires should be installed on all wheels.

n Driving with tire chains

Observe the following precautions to reduce the risk of accidents. Failing to do so may result in the vehicle being unable to be driven safely, and may cause death or serious injury.

- I** Do not drive in excess of the speed limit specified for the tire chains being used, or 30 mph (50 km/h), whichever is lower.
- I** Avoid driving on bumpy road surfaces or over potholes.
- I** Avoid sudden turns and braking, as use of chains may adversely affect vehicle handling.
- I** Slow down sufficiently before entering a curve to ensure that vehicle control is maintained.

2

When driving

2-5. Driving information

NOTICE

n Repairing or replacing snow tires

Request repairs of and obtain replacement snow tires from Toyota dealers or legitimate tire retailers.

This is because the removal and attachment of snow tires affects the operation of the tire pressure warning valves and transmitters.

n Fitting tire chains

The tire pressure warning valves and transmitters may not function correctly when tire chains are fitted.

2-5. Driving information

Trailer towing

Your vehicle is designed primarily as a passenger carrying vehicle. Towing a trailer will have an adverse effect on handling, performance, braking, durability, and fuel consumption. For your safety and the safety of others, do not overload the vehicle or trailer.

To tow a trailer safely, use extreme care and drive the vehicle in accordance with the trailer's characteristics and operating conditions.

The vehicle stability and braking performance are affected by trailer stability, brake setting and performance, and the hitch.

Toyota warranties do not apply to damage or malfunction caused by towing a trailer for commercial purposes.

Contact your Toyota dealer for further information about additional requirements such as a towing kits, etc.

2

When driving

2-5. Driving information

Weight limits

Confirm that the gross trailer weight, gross vehicle weight, gross axle weight and trailer tongue load are all within the limits.

! The gross trailer weight must never exceed towing capacity described below.

With towing package:

- ▶ 2GR-FE engine
3500 lb. (1585 kg)
- ▶ 1AR-FE engine
2500 lb. (1135 kg)

Without towing package: 1000 lb. (450 kg)

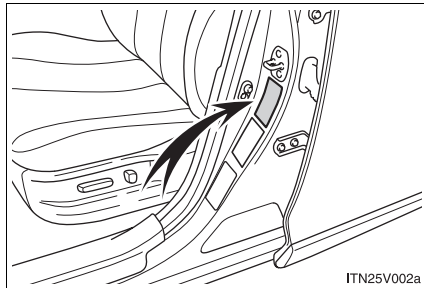

! The gross vehicle weight must never exceed the GVWR indicated on the Certification Label.

! The gross axle weight on each axle must never exceed the GAWR indicated on the Certification Label.

Towing related term

Towing related term	Meaning
GVWR (Gross Vehicle Weight Rating)	The maximum allowable gross vehicle weight. The gross vehicle weight is the total weight of the vehicle. When towing a trailer, it is the sum of the vehicle weight (including the occupants, cargo and any optional equipment installed on the vehicle) and the tongue load.

2-5. Driving information

Towing related term	Meaning
GAWR (Gross Axle Weight Rating)	The maximum allowable gross axle weight. The gross axle weight is the load placed on each axle (front and rear).
Gross trailer weight	The sum of the trailer weight and the weight of the cargo in the trailer.
Towing capacity	The maximum allowable gross trailer weight. Towing capacity is calculated considering base vehicle with necessary vehicle equipment and occupants. Additional optional equipment, passengers and cargo in the vehicle will reduce the towing capacity, gross trailer weight includes the trailer, cargo and necessary equipment for towing.
Tongue load	The load placed on the trailer hitch ball.

2

When driving

2-5. Driving information

Trailer tongue load

- 1 A recommended tongue load varies in accordance with the types of trailers or towing as described below.
- 1 In order to ensure the recommended values shown below, the trailer must be loaded by referring to the following instructions.
The trailer cargo load should be distributed so that the tongue load is 9 to 11 % of the gross trailer weight.
(Tongue load / Gross trailer weight \times 100 = 9 to 11 %)

If the gross trailer weight is over 2000 lbs. (900 kg), it is necessary to use a sway control device with sufficient capacity.

The gross trailer weight and tongue load can be measured with platform scales found at a highway weighing station, building supply company, trucking company, junk yard, etc.

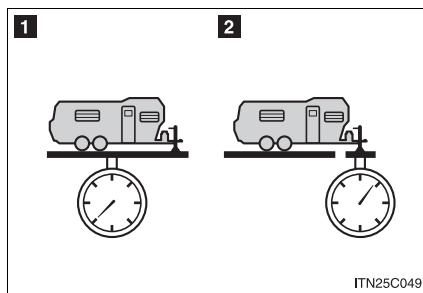

- 1 Gross trailer weight
- 2 Tongue load

Hitch

Trailer hitch assemblies have different weight capacities established by the hitch manufacturer. Even though the vehicle may be rated for towing a higher weight, the operator must never exceed the maximum weight rating specified for the trailer hitch.

Selecting trailer ball

Use the correct trailer ball for your application.

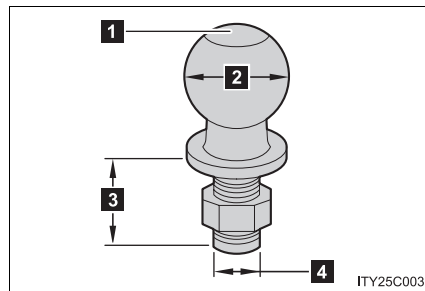

1 Trailer ball load rating

Matches or exceeds the gross trailer weight rating of the trailer.

2 Ball diameter

Matches the size of the trailer coupler. Most couplers are stamped with the required trailer ball size.

3 Shank length

Protrudes beyond the bottom of the lock washer and nut at least 2 threads.

4 Shank diameter

Matches the ball mount hole diameter size.

2

When driving

2-5. Driving information

Trailer towing tips

Your vehicle will handle differently when towing a trailer. In order to avoid accident, death or serious injury, keep the following in mind when towing.

- 1 Before starting out, check the trailer lights and the vehicle-trailer connections. Recheck after driving a short distance.
- 1 Practice turning, stopping and reversing with the trailer attached in an area away from traffic until you become accustomed to the feel of the vehicle.
- 1 Reversing with a trailer attached is difficult and requires practice. Grip the bottom of the steering wheel and move your hand to the left to move the trailer to the left. Move your hand to the right to move the trailer to right. (This is generally opposite to reversing without a trailer attached.) Avoid sharp or prolonged turning. Have someone guide you when reversing to reduce the risk of an accident.
- 1 As stopping distance is increased when towing a trailer, vehicle-to-vehicle distance should be increased. For each 10 mph (16 km/h) of speed, allow at least one vehicle and trailer length.
- 1 Avoid sudden braking as you may skid, resulting in jackknifing and loss of control. This is especially true on wet or slippery surfaces.
- 1 Avoid jerky starts or sudden acceleration.
- 1 Avoid jerky steering and sharp turns, and slow down before making turns.

2-5. Driving information

- 1 Note that when making a turn, the trailer wheels will be closer than the vehicle wheels to the inside of the turn. Compensate by making a larger than normal turning radius.
- 1 Crosswinds and rough roads will adversely affect handling of your vehicle and trailer, causing sway. Periodically check the rear to prepare for being passed by large trucks or buses, which may cause your vehicle and trailer to sway. If swaying occurs, firmly grip the steering wheel, reduce speed immediately but gradually, and steer straight ahead. Never increase speed. If you make no extreme correction with the steering or brakes, your vehicle and trailer will stabilize.
- 1 Take care when passing other vehicles. Passing requires considerable distance. After passing a vehicle, do not forget the length of your trailer, and be sure you have plenty of room before changing lanes.
- 1 To maintain engine braking efficiency and charging system performance when using engine braking, do not use overdrive. Transmission shift range position must be in "4", in "S" mode.
- 1 Due to the added load of the trailer, your vehicle's engine may overheat on hot days (at temperatures over 85°F [30°C]) when driving up a long or steep grade. If the engine coolant temperature gauge indicates overheating, immediately turn off the air conditioning (if in use), pull your vehicle off the road and stop in a safe spot. (→P. 600)

2

When driving

2-5. Driving information

- 1 Always place wheel blocks under both the vehicle and the trailer wheels when parking. Apply the parking brake firmly, and put the transmission in "P". Avoid parking on a slope, but if unavoidable, do so only after performing the following:

STEP 1 Apply the brakes and keep them applied.

STEP 2 Have someone place wheel blocks under both the vehicle and trailer wheels.

STEP 3 When the wheel blocks are in place, release the brakes slowly until the blocks absorb the load.

STEP 4 Apply the parking brake firmly.

STEP 5 Shift into "P" and turn off the engine.

- 1 When restarting after parking on a slope:

STEP 1 With the transmission in the "P" position, start the engine. Be sure to keep the brake pedal pressed.

STEP 2 Shift into "3", "2", "1" range of "S", or "R" position (if reversing).

STEP 3 Release the parking brake and brake pedal, and slowly pull or back away from the wheel blocks. Stop and apply the brakes.

STEP 4 Have someone retrieve the blocks.

n Matching trailer ball height to trailer coupler height

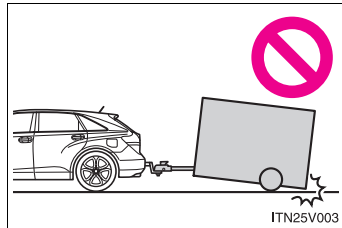

No matter which class of tow hitch applies, for a safe trailer hookup, the trailer ball setup on must be proper height for the coupler on the trailer.

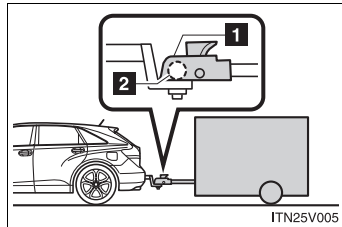

- 1 Coupler
- 2 Trailer ball

2

When driving

n Before towing

Check that the following conditions are met:

- 1 The vehicle's tires are properly inflated.
- 1 Trailer tires are inflated according to the trailer manufacturer's recommendation.
- 1 All trailer lights work.
- 1 All lights work each time you connect them.
- 1 The vehicle remains level when a loaded or unloaded trailer is hitched. Do not drive if the vehicle is not level, and check for improper tongue load, overloading, worn suspension, or other possible causes.
- 1 The trailer cargo is securely loaded.
- 1 The rear view mirrors conform to all applicable federal, state/provincial or local regulations. If they do not, install rear view mirrors appropriate for towing purposes.

2-5. Driving information

n Break-in schedule

If your vehicle is new or equipped with any new power train components (such as an engine, transmission, differential and wheel bearing), Toyota recommends that you do not tow a trailer until it has been driven for over 500 miles (800 km).

However, avoid full throttle acceleration.

n Maintenance

l If you tow a trailer, your vehicle will require more frequent maintenance due to the additional load. (See “Scheduled Maintenance Guide” or “Owner’s Manual Supplement”.)

l Retighten the fixing bolts of the towing ball after approximately 600 miles (1000 km) of trailer towing.

CAUTION

n Trailer towing precautions

l Follow all the instructions described in this section. Failure to do so could cause an accident resulting in death or serious injury.

l Exceeding the towing capacity, GVWR or GAWR can cause an accident resulting in death or serious personal injuries.

⚠ CAUTION**n To avoid accident or injury**

- l Do not exceed the trailer hitch assembly weight, gross vehicle weight, gross axle weight and trailer tongue load capacities.
- l Never load more weight in the back than in the front of the trailer. About 60% of the load should be in the front half of the trailer, and the remaining 40% in the rear.
- l Do not exceed 45 mph (72 km/h) or the posted towing speed limit, whichever is lower. As instability (swaying) of the towing vehicle-trailer combination increases as speed increases, exceeding 45 mph (72 km/h) may cause loss of control.
- l Do not use cruise control when you are towing.
- l Slow down and downshift before descending steep or long downhill grades. Do not make sudden downshifts while descending steep or long downhill grades.
- l Avoid holding the brake pedal down too long or applying the brakes too frequently. This could cause the brakes to overheat and result in reduced braking efficiency.
- l Do not tow the vehicle with the compact spare tire installed.

n Hitches

- l If you wish to install a trailer hitch, contact your Toyota dealer.
- l Use only a hitch that conforms to the gross trailer weight requirement.
- l Follow the directions supplied by the hitch manufacturer.
- l Lubricate the hitch ball with a light coat of grease.
- l Remove the trailer hitch whenever you are not towing a trailer. After removing the hitch, seal any mounting hole in the vehicle body to prevent entry of any substances into the vehicle.

2

When driving

2-5. Driving information

CAUTION

n When towing a trailer

- I** If the gross trailer weight exceeds 1000 lb. (450 kg), trailer brakes are required. Toyota recommends trailers with brakes that conform to all applicable federal and state/provincial regulations.
- I** Never tap into your vehicle's hydraulic system, as this will lower the vehicle's braking effectiveness.
- I** Never tow a trailer without using a safety chain securely attached to both the trailer and the vehicle. If damage occurs to the coupling unit or hitch ball, there is danger of the trailer wandering into another lane.

NOTICE

n When installing a trailer hitch

- I** Use only the position recommended by your Toyota dealer. Do not install the trailer hitch on the bumper; this may cause body damage.
- I** Do not use axle-mounted hitches, as they can cause damage to the axle housing, wheel bearings, wheels or tires.

n Safety chain

A safety chain must always be used between the towing vehicle and the trailer. Leave sufficient slack in the chain for turns. The chain should cross under the trailer tongue to prevent the tongue from dropping to the ground in the case that it becomes damaged or separated. For the correct safety chain installation procedure, ask your Toyota dealer.

n Do not directly splice trailer lights

Directly splicing trailer lights may damage your vehicle's electrical system and cause a malfunction.

2-5. Driving information

Dinghy towing

Your vehicle is not designed to be dinghy towed (with four wheels on the ground) behind a motor home.

NOTICE

n To avoid serious damage to your vehicle

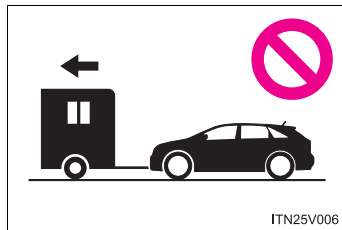

Do not tow your vehicle with four wheels on the ground.

n To prevent causing serious damage to the transmission and Active Torque Control 4WD system (AWD models)

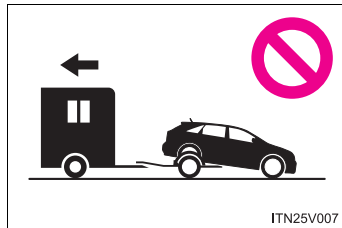

2WD models: Never tow this vehicle from the rear with the front wheels on the ground. This may cause serious damage to the transmission.

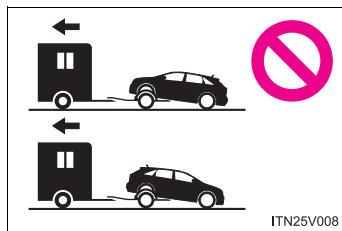

AWD models: Never tow this vehicle with any of the wheels on the ground. This may cause serious damage to the transmission and Active Torque Control 4WD system.

2

When driving

3-1. Using the air conditioning system and defogger

Automatic air conditioning system 262
Manual air conditioning system 272
Rear window defogger 278

3-2. Using the audio system

Audio system type..... 280
Using the radio 284
Using the CD player 293
Playing back
MP3 and WMA discs 303
Operating an iPod 313
Operating a USB memory 320
Optimal use of the audio system..... 328
Using the AUX port 333
Using the steering switches 334

3-3. Using the Bluetooth® audio system

Bluetooth® audio system..... 338
Using the Bluetooth® audio system..... 341
Operating a Bluetooth® enabled portable player 348
Setting up a Bluetooth® enabled portable player 350
Bluetooth® audio system setup 355

Interior features

3

3-4. Using the rear seat entertainment system

- Rear seat entertainment system features 356
- Using the DVD player (DVD video) 365
- Using the DVD player (video CD) 374
- Using the DVD player (audio CD/CD text) 377
- Using the DVD player (MP3 discs) 378
- Using the video mode 380
- Changing the initial settings 382

3-5. Using the hands-free system (for cellular phone)

- Hands-free system (for cellular phone) 391
- Using the hands-free system 394
- Making a phone call 403
- Setting a cellular phone 409
- Security and system setup 416
- Using the phone book 421

3-6. Using the interior lights

- Interior lights list 430
- Personal/interior light main switch 431
- Personal/interior lights and luggage compartment light 432

3-7. Using the storage features

- List of storage features 434
- Glove box 435
- Console boxes 436
- Overhead console 438
- Cup holders 439
- Bottle holders 441
- Auxiliary boxes 442

3-8. Other interior features

- Sun visors 445
- Vanity mirror 446
- Power outlets 447
- Seat heaters 450
- Armrest 452
- Floor mats 453
- Luggage compartment features 455
- Garage door opener 457
- Compass 464

3-1. Using the air conditioning system and defogger

Automatic air conditioning system

Airflow and outlets are automatically adjusted according to the temperature setting.

► Control panel

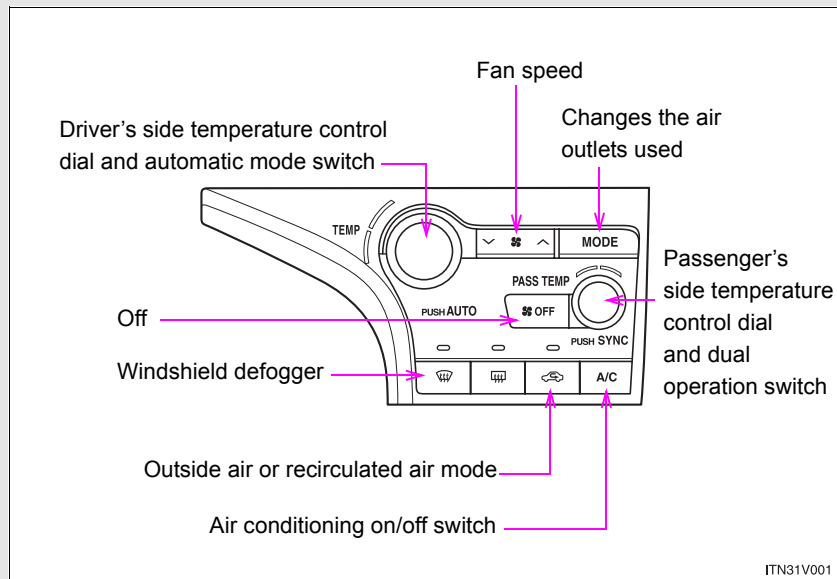

3-1. Using the air conditioning system and defogger

► Multi-information display (TFT type)

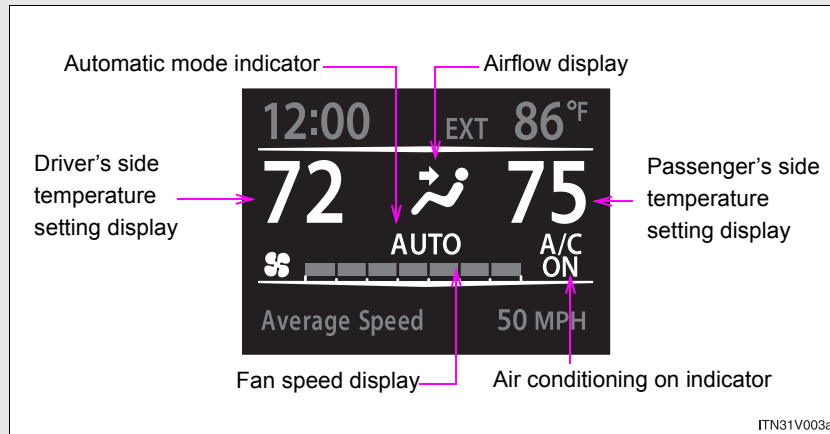

The settings display will differ according to the situation. If  is pressed while in automatic mode, the status of all settings will be displayed for a number of seconds.

► Multi-information display (LCD type)

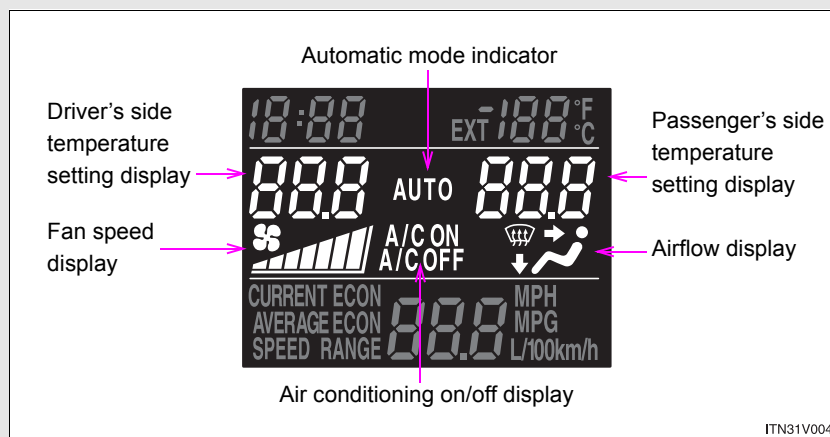

3-1. Using the air conditioning system and defogger

Using the automatic mode

STEP 1 Press

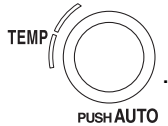

The air conditioning system will begin to operate. In outside air or recirculated air mode, air outlets, fan speed and air conditioning on/off are automatically adjusted according to the temperature setting.

“AUTO” will be displayed on the multi-information display, along with the temperature setting. The settings that are automatically adjusted by the system are not displayed. When only “AUTO” and the temper-

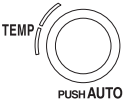
ature settings are displayed,  may be pressed a second time to temporarily display all system settings.

STEP 2 Turn the temperature control dial clockwise (warm) or counterclockwise (cool).

The temperature for the driver's and front passenger's seats can be set separately.

3-1. Using the air conditioning system and defogger

Adjusting the settings

▮ Adjusting the temperature setting

Turn the temperature control dial clockwise (warm) or counter-clockwise (cool).

The air conditioning system switches between dual and simultaneous modes each time  is pressed.

Each temperature setting will be displayed on the multi-information display.

Dual mode: The temperature for the driver's seat and front passenger's seats can be set separately.

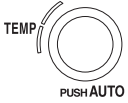
SYNC mode: Only  (driver's side) can be used to adjust the temperature for all seats.

In SYNC mode, only one temperature setting will be displayed on the multi-information display.

3

Interior features

3-1. Using the air conditioning system and defogger

n Adjusting the fan speed

Press “^” (increase) or “v” (decrease) on .

The fan speed is shown on the display. (7 levels)
 Pressing the button while in automatic mode will place the fan speed into manual mode. “AUTO” will turn off, and the fan speed setting will be displayed. The air outlet setting will remain in automatic mode.

Press  to turn the fan off.

The air conditioning system display will go blank to indicate that the system is off. If the system is in outside air mode, some outlet airflow may still exist.

n Changing the air outlets

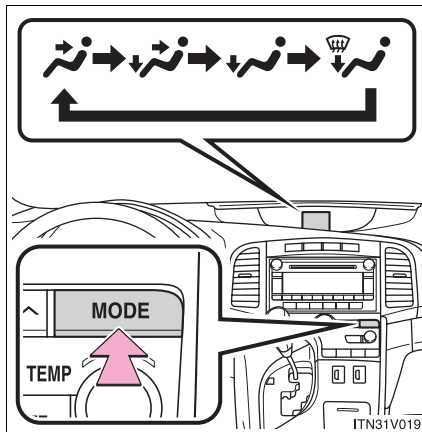

Press .

The air outlets switch each time the button is pressed.

Pressing the button while in automatic mode will place the air outlets into manual mode. “AUTO” will turn off, and the air outlet setting will be displayed. The fan speed setting will remain in automatic mode.

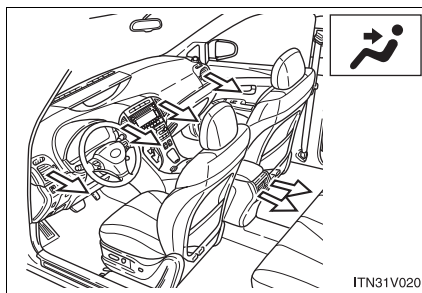

Air flows to the upper body.

3-1. Using the air conditioning system and defogger

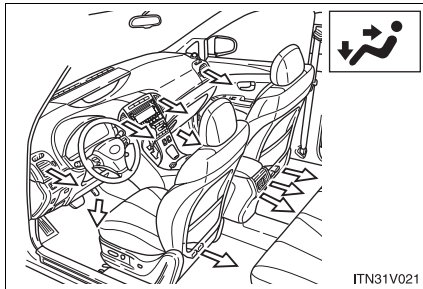

Air flows to the upper body and feet.

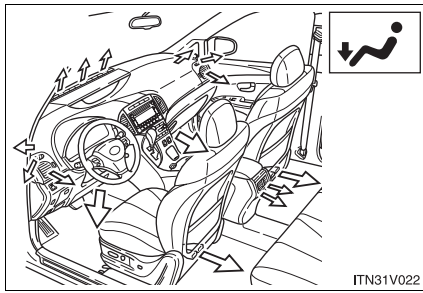

Mainly air flows to the feet.

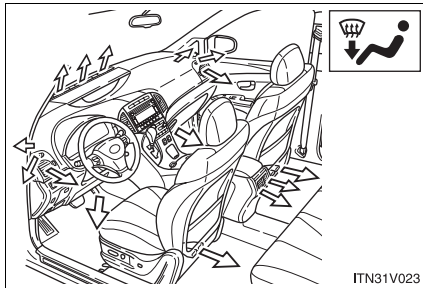

Air flows to the feet and the windshield defogger operates.

3

Interior features

n Switching between outside air and recirculated air modes

Press .

The mode switches between outside air mode (indicator off) and recirculated air mode (indicator on) each time the button is pressed.

3-1. Using the air conditioning system and defogger

Defogging the windshield

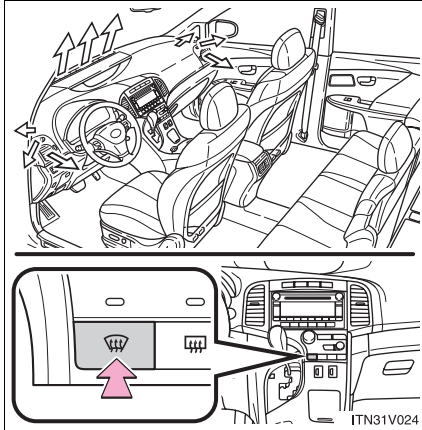

Press .

The air conditioning system control operates automatically.

Recirculated air mode will automatically switch to outside air mode. It is not possible to return to recirculated air mode when the switch is on.

Pressing  again will revert to the previous air outlet mode.

Adjusting the position and opening and closing the air outlets

► Front center outlets

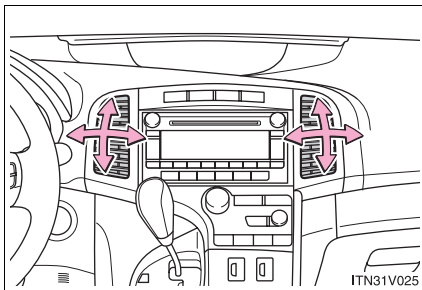

Direct air flow to the left or right, up or down.

3-1. Using the air conditioning system and defogger

► Front side outlets

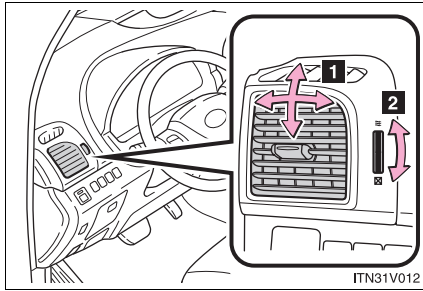

- 1** Direct air flow to the left or right, up or down.
- 2** Turn the knob to open or close the vent.

► Rear center outlets

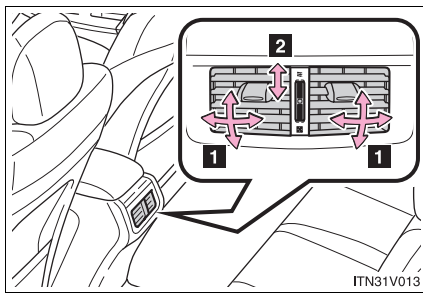

- 1** Direct air flow to the left or right, up or down.
- 2** Turn the knob to open or close the vent.

3

Interior features

3-1. Using the air conditioning system and defogger

n Using the automatic mode

Fan speed is adjusted automatically in accordance with the temperature setting and ambient conditions. As a result, the following may occur.

- l The system may switch automatically to recirculated air mode when the coolest temperature setting is selected.

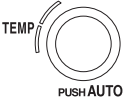
- l Immediately after  is pressed, the fan may stop for a while until warm or cool air is ready to flow.

- l Cool air may flow to the area around the upper body when the heater is on.

n Using the system in recirculated air mode

The windows will fog up more easily if the recirculated air mode is used for an extended period.

n Window defogger feature

Recirculated air mode may automatically switch to outside air mode in situations where the windows need to be defogged.

n When outside temperature reaches approximately 32°F (0°C)

The air conditioning system may not operate even when  is pressed.

n Air conditioning odors

- l During use, various odors from inside and outside the vehicle may enter into and accumulate in the air conditioning system. This may then cause odor to be emitted from the vents.

- l To reduce potential odors from occurring:

- It is recommended that the air conditioning system be set to outside air mode prior to turning the vehicle off.
- The start timing of the blower may be delayed for a short period of time immediately after the air conditioning system is started in the automatic mode.

3-1. Using the air conditioning system and defogger

CAUTION

n To prevent the windshield from fogging up

Do not use  during cool air operation in extremely humid weather. The difference between the temperature of the outside air and that of the windshield can cause the outer surface of the windshield to fog up, blocking your vision.

NOTICE

n To prevent battery discharge

Do not leave the air conditioning system on longer than necessary when the engine is stopped.

3

Interior features

3-1. Using the air conditioning system and defogger

Manual air conditioning system

► Control panel

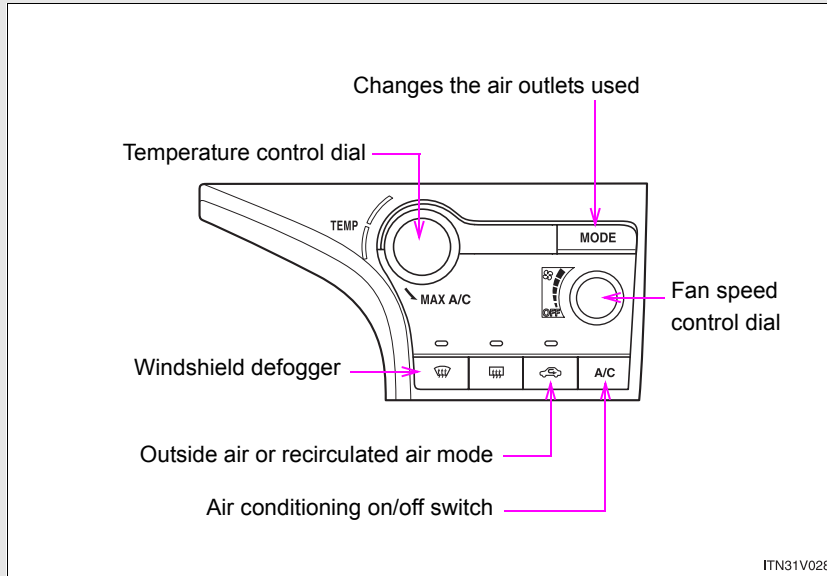

► Multi-information display

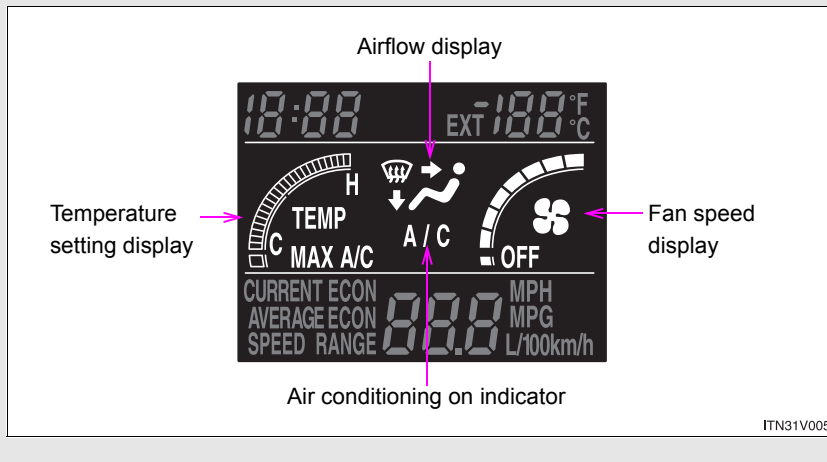

3-1. Using the air conditioning system and defogger

Adjusting the settings

n Adjusting the temperature setting

Turn the temperature control dial clockwise (warm) or counter-clockwise (cool).

If  is not pressed, the system will blow ambient temperature air or heated air.

For quick cooling, turn the temperature selector knob to the “MAX A/C” position. The air conditioning will automatically turn on and, depending on the air outlet mode, the air intake mode will be set to recirculated air mode.

n Adjusting the fan speed

Turn the fan speed control dial clockwise (increase) or counter-clockwise (decrease).

Set the dial to “OFF” to turn the fan off.

n Changing the air outlets

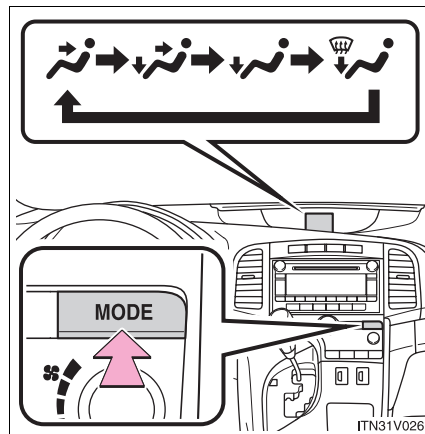

Press  .

The air outlets switch each time the button is pressed.

3

Interior features

3-1. Using the air conditioning system and defogger

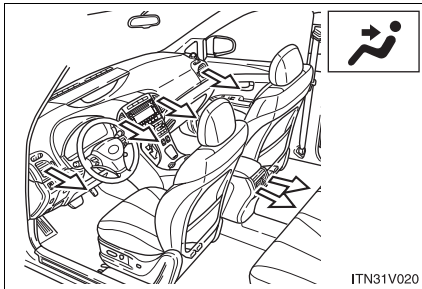

Air flows to the upper body.

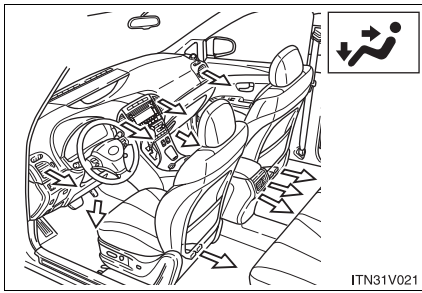

Air flows to the upper body and feet.

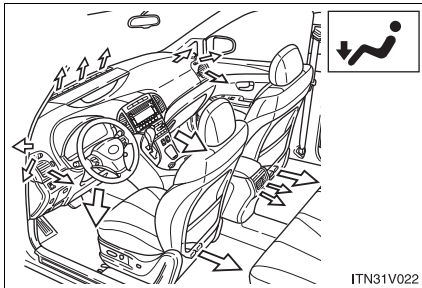

Mainly air flows to the feet.

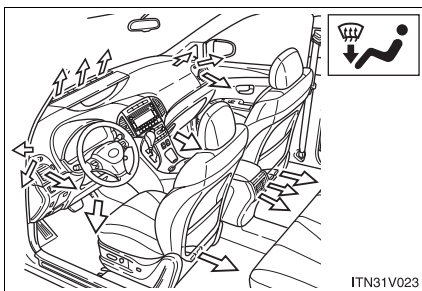

Air flows to the feet and the windshield defogger operates.

The air intake is automatically switched to outside air mode.

3-1. Using the air conditioning system and defogger

n **Switching between outside air and recirculated air modes**

Press  .

The mode switches between outside air mode (indicator off) and recirculated air mode (indicator on) each time the button is pressed.

If the ambient temperature drops, the mode will automatically change from recirculated air mode to outside air mode after a few minutes. This automatic change control mode can be cancelled by pushing and holding the button for longer than 2 seconds. The automatic change control mode will be reactivated if the “ENGINE START STOP” switch is turned off (vehicles with smart key system) or the engine switch is turned to the “LOCK” position (vehicles without smart key system).

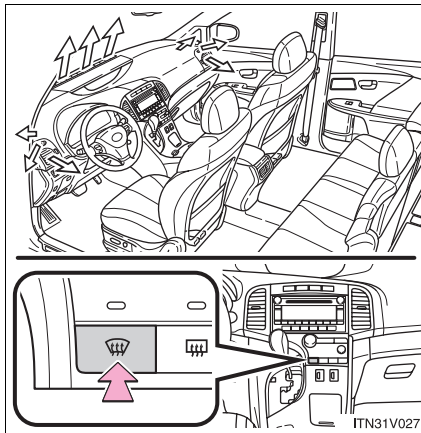
Defogging the windshield

Press  .

The air conditioning system control operates automatically.

Recirculated air mode will automatically switch to outside air mode. It is not possible to return to recirculated air mode when the switch is on.

Pressing  again will revert to the previous air outlet mode.

3

Interior features

3-1. Using the air conditioning system and defogger

Adjusting the position and opening and closing the air outlets

► Front center outlets

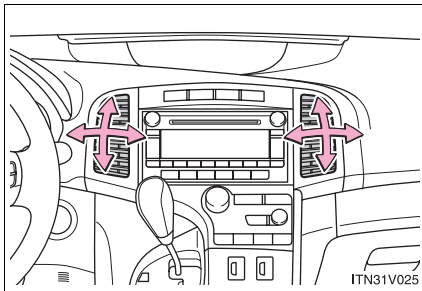

Direct air flow to the left or right, up or down.

► Front side outlets

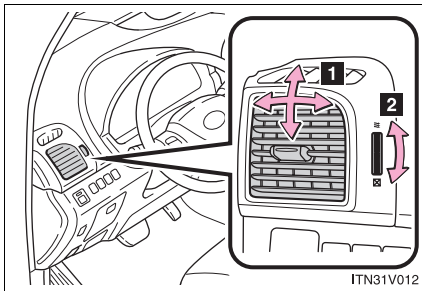

1 Direct air flow to the left or right, up or down.

2 Turn the knob to open or close the vent.

► Rear center outlets

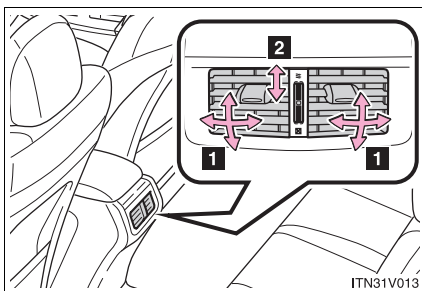

1 Direct air flow to the left or right, up or down.

2 Turn the knob to open or close the vent.

3-1. Using the air conditioning system and defogger

n Using the system in recirculated air mode

The windows will fog up more easily if the recirculated air mode is used for an extended period.

n Window defogger feature

Recirculated air mode may automatically switch to outside air mode in situations where the windows need to be defogged.

n When outside temperature reaches approximately 32°F (0°C)

The air conditioning system may not operate even when  is pressed.

n Air conditioning odors

l During use, various odors from inside and outside the vehicle may enter into and accumulate in the air conditioning system. This may then cause odor to be emitted from the vents.

l To reduce potential odors from occurring:

It is recommended that the air conditioning system be set to outside air mode prior to turning the vehicle off.

3

Interior features

⚠ CAUTION**n To prevent the windshield from fogging up**

Do not use  during cool air operation in extremely humid weather. The difference between the temperature of the outside air and that of the windshield can cause the outer surface of the windshield to fog up, blocking your vision.

⚠ NOTICE**n To prevent battery discharge**

Do not leave the air conditioning system on longer than necessary when the engine is stopped.

3-1. Using the air conditioning system and defogger

Rear window defogger

Clear the rear window using the defogger.

► With automatic air conditioning system

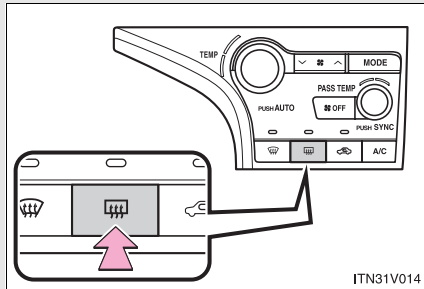

On/off

The defogger will automatically turn off after 15 or 60 minutes. This operation time changes according to the ambient temperature and vehicle speed. Pressing the switch again also turns the defogger off.

► With manual air conditioning system

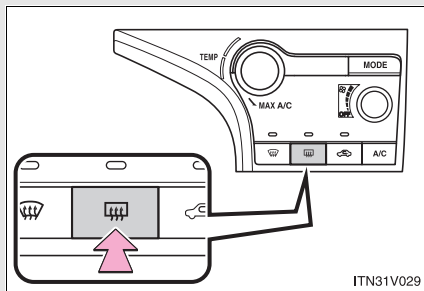

3-1. Using the air conditioning system and defogger

n The rear window defogger can be operated when

- ▶ Vehicles with smart key system

The “ENGINE START STOP” switch is in IGNITION ON mode.

- ▶ Vehicles without smart key system

The engine switch is in the “ON” position.

n Outside rear view mirror defoggers and windshield wiper de-icer (if equipped)

Turning the rear window defogger on will turn the outside rear view mirror defoggers and the windshield wiper de-icer on.

The outside rear view mirror is used to remove raindrops, dew and frost from the outside rear view mirrors.

The windshield wiper de-icer is used to prevent ice from building up on the windshield and wiper blades.

3

Interior features

⚠ CAUTION

n Outside rear view mirror defoggers and windshield wiper de-icer (if equipped)

Do not touch the rear view mirror surfaces, the glass at the lower part of the windshield or to the side of the front pillars, as they can become very hot and burn you.

⚠ NOTICE

n To prevent battery discharge

Turn the defoggers off when the engine is not running.

3-2. Using the audio system

Audio system type

- ▶ **With navigation system**
Owners of models equipped with a navigation system should refer to the “Navigation System Owner’s Manual”.
- ▶ **Without navigation system**
Type A: CD player and AM/FM radio (with CD changer controller)

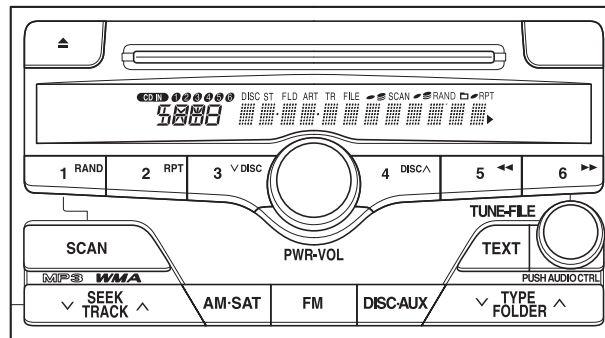

ITN32V003

3-2. Using the audio system

Type B: CD player and AM/FM radio (with CD changer controller)

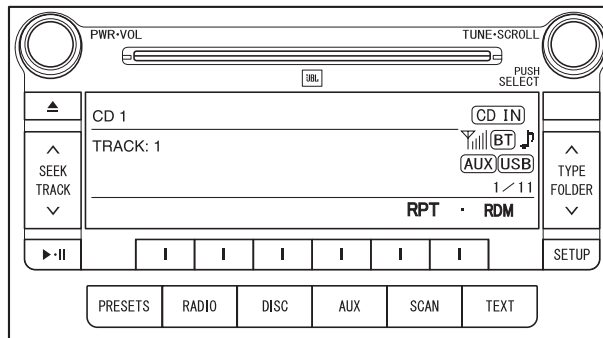

ITN32V011a

Type C: CD player with changer and AM/FM radio

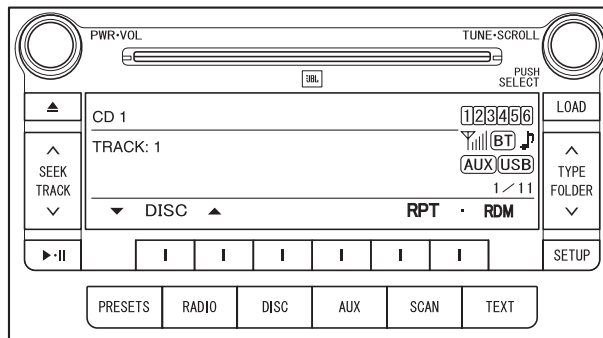

ITN32V017

3-2. Using the audio system

Title	Page
Using the radio	P. 284
Using the CD player	P. 293
Playing back MP3 and WMA discs	P. 303
Operating an iPod	P. 313
Operating a USB memory	P. 320
Optimal use of the audio system	P. 328
Using the AUX port	P. 333
Using the steering switches	P. 334

Language settings (type B and C)

The language used for all voice guidance, voice recognition and messages may be changed.

STEP 1 Press  .

STEP 2 Press  that corresponds to "MORE".

STEP 3 Press  that corresponds to "LANG".

STEP 4 Press  that corresponds to the desired language.

- ▶ For vehicles sold in the U.S.A.
"ENG" (English) or "ESP" (Spanish)
- ▶ For vehicles sold in the Canada
"ENG" (English) or "FRAN" (French)

n Using cellular phones

Interference may be heard through the audio system's speakers if a cellular phone is being used inside or close to the vehicle while the audio system is operating.

3-2. Using the audio system

CAUTION

n For vehicles sold in the U.S.A.

l Part 15 of the FCC Rules

FCC Warning:

Any unauthorized changes or modifications to this equipment will void the user's authority to operate this device.

l Laser products

- Do not take this unit apart or attempt to make any changes yourself. This is an intricate unit that uses a laser pickup to retrieve information from the surface of compact discs. The laser is carefully shielded so that its rays remain inside the cabinet. Therefore, never try to disassemble the player or alter any of its parts since you may be exposed to laser rays and dangerous voltages.
- This product utilizes a laser.

Use of controls or adjustments or performance of procedures other than those specified herein may result in hazardous radiation exposure.

3

Interior features

NOTICE

n To prevent battery discharge

Do not leave the audio system on longer than necessary with the engine off.

n To avoid damaging the audio system

Take care not to spill drinks or other fluids over the audio system.

3-2. Using the audio system

Using the radio

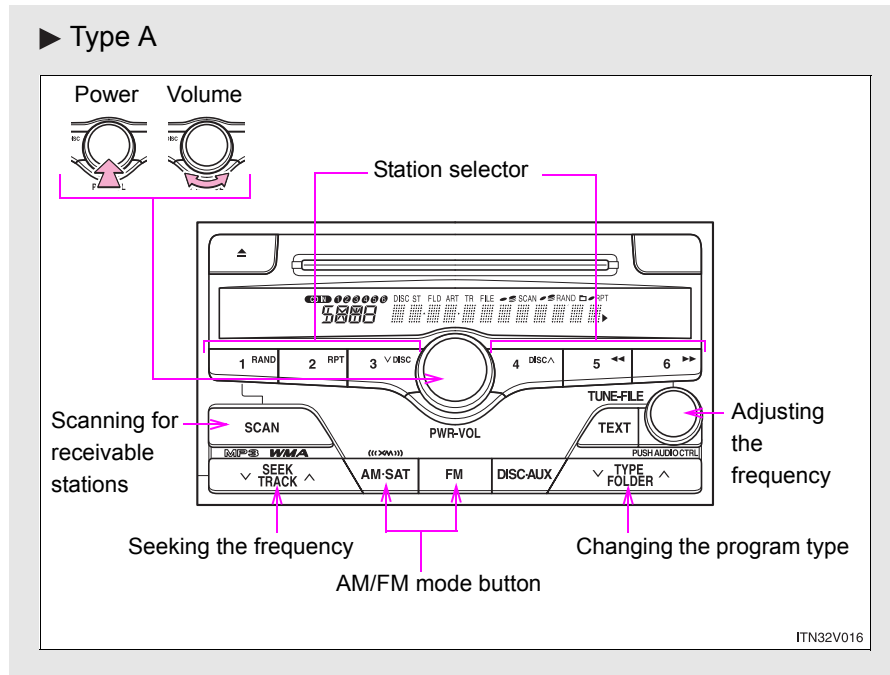

3-2. Using the audio system

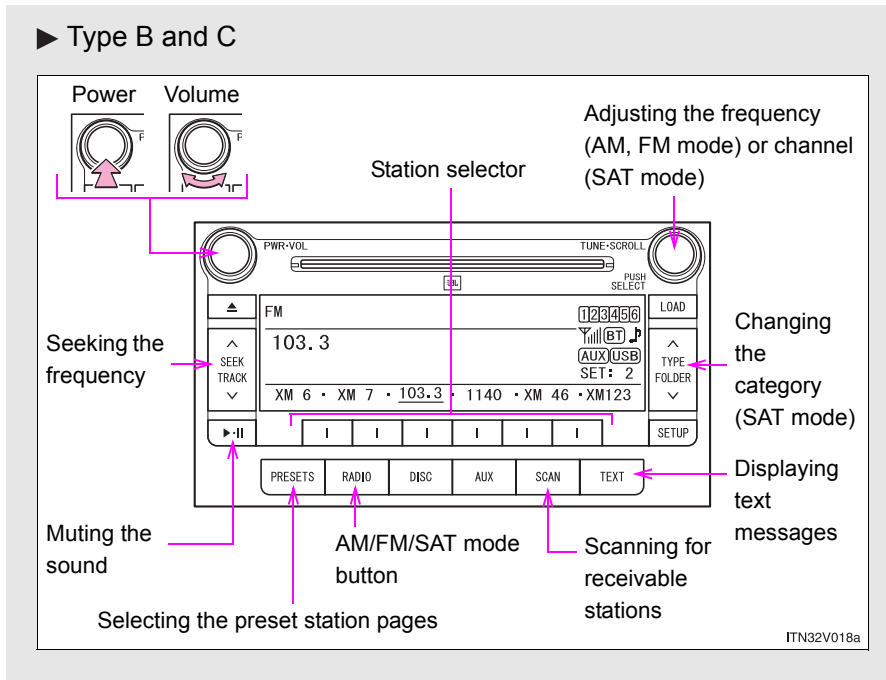







3

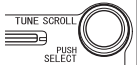

Interior features

3-2. Using the audio system

Setting station presets (excluding XM[®] Satellite Radio)

- STEP 1** Search for desired stations by turning  or  or pressing “^” or “v” on  or .

- STEP 2** Press and hold the button (from  to  or one of ) the station is to be set to, and you hear a beep.

Type B and C: Each preset page may contain AM, FM, or XM radio station presets. Pressing  will change between AM, FM, and XM modes but will not change the preset page display. Press  to change the presets page. There are a total of 6 pages.



The number of preset pages can be customized from 1 to 6. (→P. 332)

Scanning radio stations (excluding XM[®] Satellite Radio)



n Scanning the preset radio stations

STEP 1 Press and hold  or  until you hear a beep.



Preset stations will be played for a few seconds each.

STEP 2 When the desired station is reached, press  or  once again.

n Scanning all radio stations within range

STEP 1 Press  or .

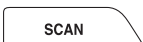
All the stations with reception will be played for a few seconds each.

STEP 2 When the desired station is reached, press  or  once again.

n Displaying radio text messages (for type B and C, FM mode only)

When a new radio text message is received, "MSG" is shown on the display. To display the message, press .

If the text continues past the end of the display, "▶" is displayed. Press and hold  until you hear a beep.

Text messages are not displayed while driving.

3-2. Using the audio system

XM[®] Satellite Radio (if equipped)

n Receiving XM[®] Satellite Radio

STEP 1 Press  .

The display changes as follows each time the button is pressed.

“AM” → “FM” → “SAT”



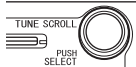

STEP 2 Turn  to select a desired channel from all the cate-

gories or press “^” or “v” on  to select a desired chan-

nel in the current category.

n Presetting XM[®] Satellite Radio channels



Select the desired channel. Press and hold the button (from one of ) until you hear a beep.

Each time  is pressed, station pages are changed. There are a total of 6 pages.

n Changing the channel category

Press “^” or “v” on  .

3-2. Using the audio system

n Scanning XM® Satellite Radio channels**l Scanning channels in the current category****STEP 1** Press  .**STEP 2** When the desired channel is reached, press the button again.**l Scanning preset channels****STEP 1** Press and hold  until you hear a beep.**STEP 2** When the desired channel is reached, press the button again.**n Displaying text information**Press  or  .Type A: Each time  is pressed, the display changes in the order of Channel name → Title (song/program title) → Name (artist name/feature) → Channel number.Type B and C: Each time  is pressed, the display changes in the order of Title (song/program title) → Name (artist name/feature)/Title (song/program title).

3

Interior features

n When the battery is disconnected

All preset stations are erased. (type A only)

n Radio antenna type**l Wire antenna**

The radio antenna is mounted inside the rear window.

3-2. Using the audio system

n **Reception sensitivity**

- l Maintaining perfect radio reception at all times is difficult due to the continually changing position of the antenna, differences in signal strength and surrounding objects, such as trains, transmitters, etc.
- l The radio antenna is mounted inside the rear window. To maintain clear radio reception, do not attach metallic window tinting or other metallic objects to the antenna wire mounted inside the rear window.

n **Receiving XM[®] Satellite Radio**

An XM[®] Satellite Radio is a tuner designed exclusively to receive broadcasts provided under a separate subscription. Availability is limited to the 48 contiguous states and some Canadian provinces.

l XM[®] subscriptions

For detailed information about XM[®] Satellite Radio or to subscribe:



U.S.A–

Visit on the web at www.xmradio.com or call 1-800-967-2346.

Canada–

Visit on the web at www.xmradio.ca or call 1-877-438-9677.

l Radio ID

You will need the radio ID when activating XM[®] service or reporting a problem. Select “CH000” using  or , and the receiver's 8-character ID number will appear.

l Satellite tuner

The tuner supports only Audio Services (Music and Talk) and the accompanying Text Information of XM[®] Satellite Radio.

3-2. Using the audio system

n If the satellite radio does not operate normally

If a problem occurs with the XM[®] tuner, a message will appear on the display. Refer to the table below to identify the problem, and take the suggested corrective action.

CHECK ANTENNA	The XM [®] antenna is not connected. Check whether the XM [®] antenna cable is attached securely.
	There is a short-circuit in the antenna or the surrounding antenna cable. See a Toyota certified dealer.
CH UNAUTHORIZED	You have not subscribed to XM [®] Satellite Radio. The radio is being updated with the latest encryption code. Contact XM [®] Satellite Radio for subscription information. When a contract is canceled, you can choose "CH000" and all free-to-air channels.
	The premium channel you selected is not authorized. Wait for about 2 seconds until the radio returns to the previous channel or "CH001". If it does not change automatically, select another channel. If you want to listen to the premium channel, contact XM [®] Satellite Radio.
NO SIGNAL	The XM [®] signal is too weak at the current location. Wait until your vehicle reaches a location with a stronger signal.
LOADING	The unit is acquiring audio or program information. Wait until the unit has received the information.
OFF AIR	The channel you selected is not broadcasting any programming. Select another channel.

3

Interior features

3-2. Using the audio system

----	There is no song/program title or artist name/feature associated with the channel at that time. No action needed.
CH UNAVAILABLE	The channel you selected is no longer available. Wait for about 2 seconds until the radio returns to the previous channel or "CH001". If it does not change automatically, select another channel.

Contact the XM® Listener Care Center at 1-800-967-2346 (U.S.A.) or 1-877-438-9677 (Canada).

n Certifications for the radio tuner

This equipment has been tested and found to comply with the limits for a class B digital device, pursuant to Part 15 of the FCC Rules. These limits are designed to provide reasonable protection against harmful interference in a residential installation. This equipment generates, uses and can radiate radio frequency energy and, if not installed and used in accordance with the instructions, may cause harmful interference to radio communications. However, there is no guarantee that interference will not occur in a particular installation.

If this equipment does cause harmful interference to radio or television reception, which can be determined by turning the equipment off and on, the user is encouraged to try to correct the interference by trying one or more of the following:

- 1 Reorienting or relocating the receiving antenna.
- 1 Increasing the separation between the equipment and receiver.
- 1 Connecting the equipment into an outlet on a circuit different from that to which the receiver is connected.
- 1 Consulting the dealer or an experienced radio/TV technician for help.

3-2. Using the audio system Using the CD player

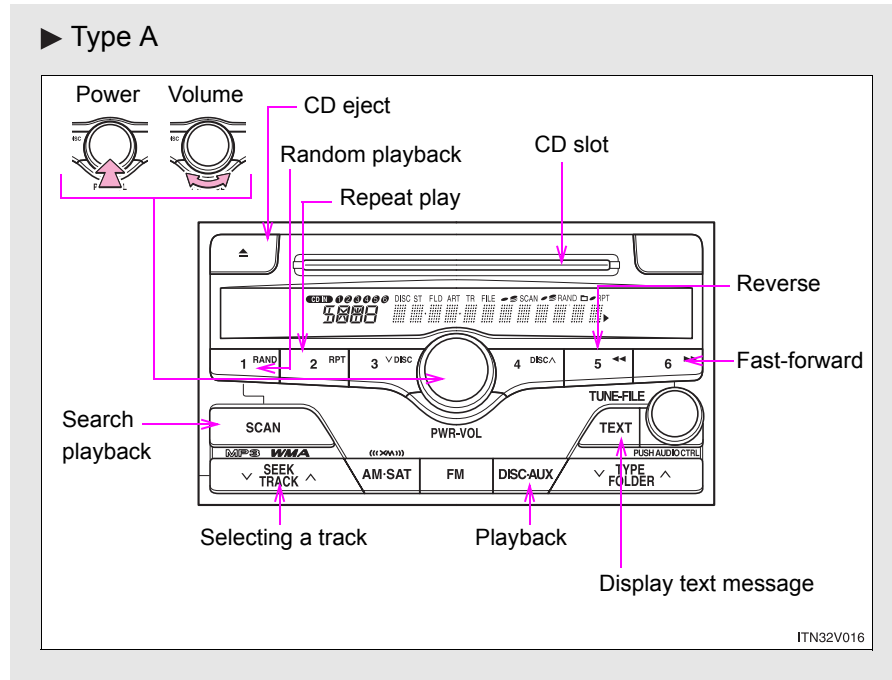

3

Interior features

3-2. Using the audio system

► Type B and C

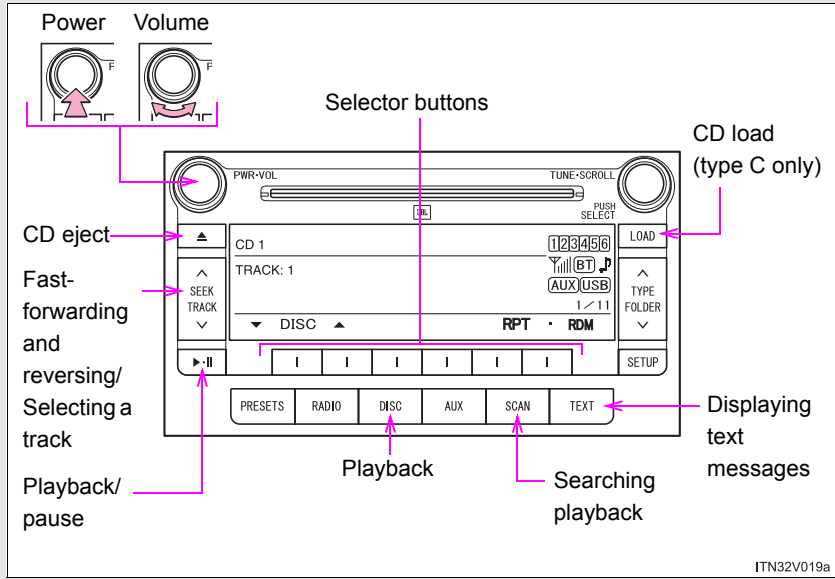

3-2. Using the audio system

Loading a CDs

n Loading a single CD

- ▶ Type A and B
Insert a CD.

- ▶ Type C

STEP 1 Press .

STEP 2 When the indicator on the slot turns from amber to green, insert a CD.

n Loading multiple CDs (type C only)

STEP 1 Press and hold until you hear a beep.

STEP 2 Insert a CD when the indicator on the slot turns from amber to green.

The indicator on the slot turns to amber when the CD is inserted.

STEP 3 Insert the next CD when the indicator on the slot turns from amber to green again.

Repeat the procedure for the remaining CDs.

To cancel the operation, press . If you do not insert a disc within 15 seconds, loading will be canceled automatically.

3

Interior features

3-2. Using the audio system

Ejecting CDs**n Ejecting a CD****► Type A and B**

Press  or  and remove the CD.

► Type C

STEP 1 To select the CD to be ejected, press  that corresponds to “▲” or “▼”.

The selected CD number is shown on the display.

STEP 2 Press  and remove the CD.

n Ejecting all CDs (type C only)

Press and hold  until you hear a beep, then remove the CDs.

Selecting a CD (with a CD changer)**n To select a CD to play**

Press  that corresponds to “▲” or “▼”.

n To scan loaded CDs

STEP 1 Press and hold  until you hear a beep.

The first 10 seconds of the first track on each CD will be played.

To cancel, press  again.

STEP 2 Press  once again when the desired CD is reached.

3-2. Using the audio system



Selecting a track

Press “^” to move up or “v” to move down using  or



until the desired track number appears on the display.

Fast-forwarding and rewinding tracks



Type A: Press and hold  (rewind) or  (fast forward).

Type B and C: Press and hold “^” or “v” on .

3

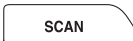

Interior features

Scanning a CD

STEP 1 Press  or .

The first 10 seconds of each track will be played.

To cancel, press  again.

STEP 2 Press  or  once again when the desired track is reached.

Playing and pausing tracks (type B and C)

Press .

3-2. Using the audio system

Random playback

n Current CD

Press  (RAND) or  that corresponds to "RDM".

Songs are played in random order.

To cancel, press the button again.

n All CDs (with a CD changer)

Press  that corresponds to "RDM" twice.

Tracks on all loaded CDs are played in random order.

To cancel, press the button again.

Repeating a track or a disc

n Repeating a track

Press  (RPT) or  that corresponds to "RPT".

To cancel, press the button again.

n Repeating a disc (with a CD changer)

Press  that corresponds to "RPT" twice.

To cancel, press the button again.

3-2. Using the audio system

Switching the display

Press  or .

Type A: Each time  is pressed, the display changes in the order of Track no./Elapsed time → CD title → Track name.

Type B and C: Each time  is pressed, the display changes in the order of Track title → Track name/Artist name → Track name/Elapsed time.

n Display (type A only)

Up to 12 characters can be displayed at a time.

If there are 13 characters or more, pressing and holding  for 1 second or more will display the remaining characters. A maximum of 24 characters can be displayed.

If  is pressed for 1 second or more again or has not been pressed for 6 seconds or more, the display will return to the first 12 characters.

Depending on the contents recorded, the characters may not be displayed properly or may not be displayed at all.



3

Interior features

3-2. Using the audio system

n Error messages

“ERROR” or “READ ERROR”: This indicates a trouble either in the CD or inside the player. The CD may be dirty, damaged or inserted up-side down.

“WAIT” or “PLEASE WAIT”: Operation has stopped due to a high temperature inside the player. Wait for a while and then press  or . Contact your Toyota dealer if the CD still cannot be played back.

n Discs that can be used

Discs with the marks shown below can be used. Playback may not be possible depending on recording format or disc features, or due to scratches, dirt or deterioration.



CDs with copy-protect features may not play correctly.

n CD player protection feature

To protect the internal components, playback is automatically stopped when a problem is detected while the CD player is being used.

n If CDs are left inside the CD player or in the ejected position for extended periods

CDs may be damaged and may not play properly.

n Lens cleaners

Do not use lens cleaners. Doing so may damage the CD player.

 NOTICE

n CDs and adapters that cannot be used

Do not use the following types of CDs, 3 in. (8 cm) CD adapters or Dual Disc.

Doing so may damage the player and/or the CD insert/eject function.

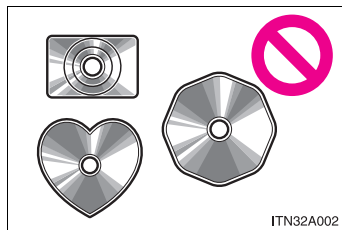

! CDs that have a diameter that is not 4.7 in. (12 cm).

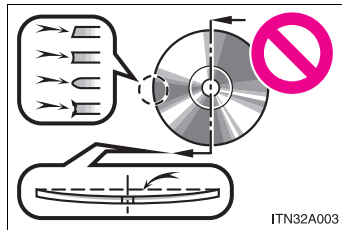

! Low-quality and deformed CDs.

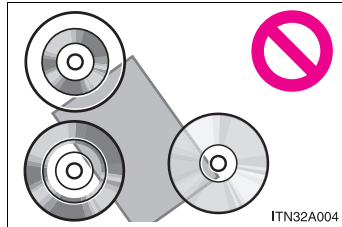

! CDs with a transparent or translucent recording area.

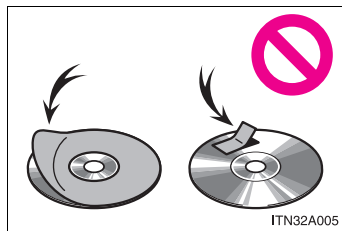

! CDs that have tape, stickers or CD-R labels attached to them, or that have the label peeled off.

3-2. Using the audio system

NOTICE

n Player precautions

Failure to follow the precautions below may result in damage to the CDs or the player itself.

- I** Do not insert anything other than CDs into the CD slot.
- I** Do not apply oil to the player.
- I** Store CDs away from direct sunlight.
- I** Never try to disassemble any part of the player.

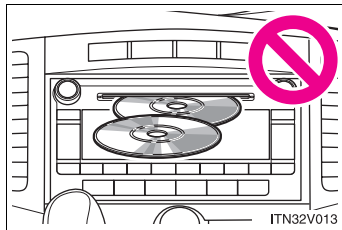

- I** Do not insert more than one CD at a time.

3-2. Using the audio system Playing back MP3 and WMA discs

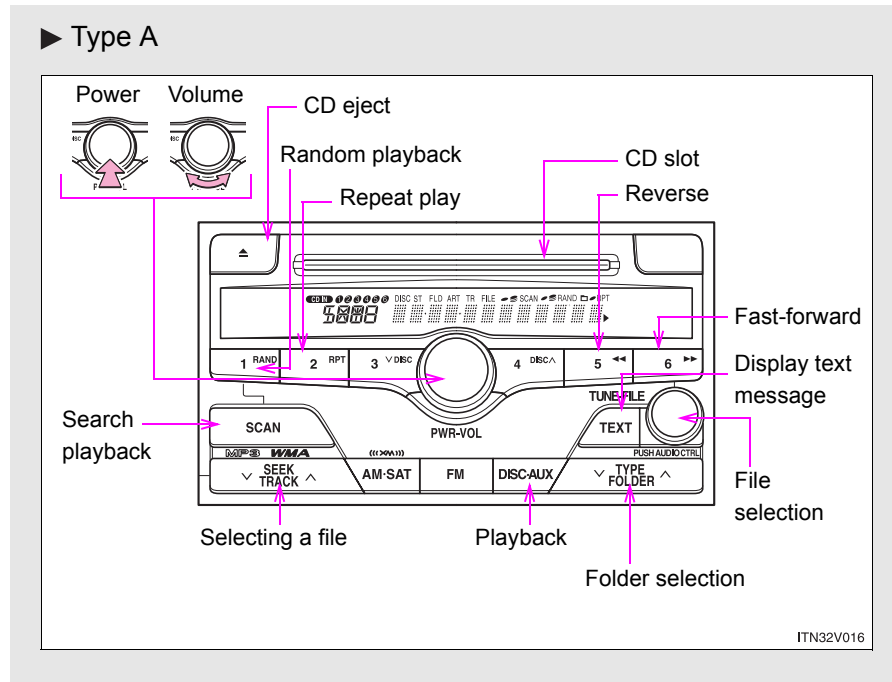

3

Interior features

3-2. Using the audio system

► Type B and C

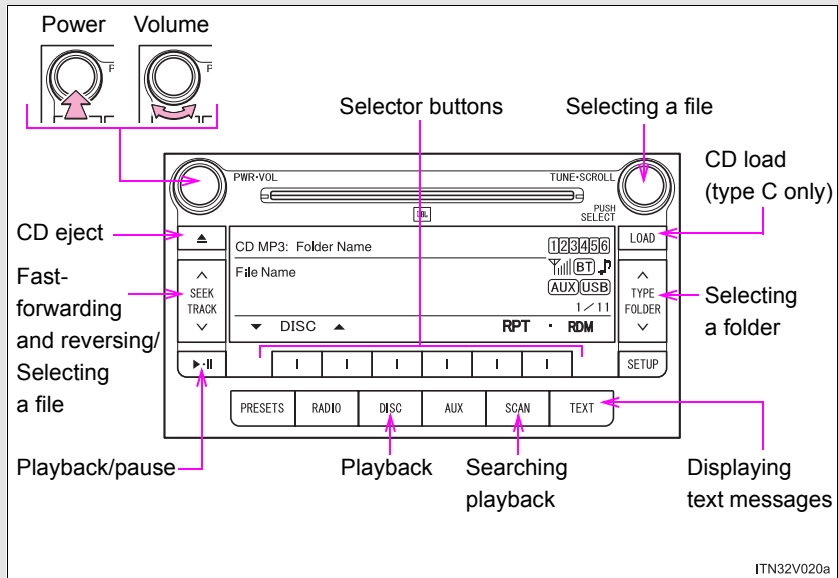

Loading and ejecting MP3 and WMA discs

→P. 293



Selecting a CD (with a CD changer)



→P. 293

3-2. Using the audio system



Selecting and scanning a folder

n Selecting folders one at a time

Press “^” or “v” on  or  to select the desired folder.



To return to the first folder, press and hold “v” on  or  until you hear a beep.

n Selecting the desired folder by cueing the first file of each folder

Press and hold  or  until you hear a beep. When the desired folder is reached, press the switch once again.

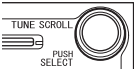

Selecting and scanning a file

n Selecting one file at a time

Turn  or  or press “^” or “v” on  or  to select the desired file.



n Selecting the desired file by cueing the files in the folder

Press  or .

When the desired file is reached, press  or  once again.

3-2. Using the audio system

Fast-forwarding and rewinding files

Type A: Press and hold  (reverse) or  (fast forward).

Type B and C: Press and hold “^” or “v” on



Playing and pausing files (type B and C)

Press .

Random playback

n To play files from a particular folder in random order

Press  (RAND) or  that corresponds to “RDM”.

To cancel, press the button again.

n To play all of the files on a disc in random order (with a CD changer)

Press  that corresponds to “RDM” twice.

To cancel, press the button again.

3-2. Using the audio system

Repeating a file or a folder**n Repeating a file**

Press  (RPT) or  that corresponds to "RPT".

To cancel, press the button again.

n Repeating a folder**▶ Type A**

Press and hold  (RPT) until you hear a beep.

To cancel, press the button again.

▶ Type B and C

Press  that corresponds to "RPT" twice.

To cancel, press the button again.

n Repeating a disc (type C only)

Press  that corresponds to "RPT" three times.

To cancel, press the same button again.

3

Interior features

Switching the display

Press  or .

Type A: Each time  is pressed, the display changes in the order of Folder no./File no./Elapsed time→Folder name→File name→Album title (MP3 only)→Track title→Artist name.

Type B and C: Each time  is pressed, the display changes in the order of Track title→Track title/Artist name→Track title/Album name→Track title/Elapsed time.



3-2. Using the audio system

n **Display**

→P. 299

n **Error messages**

“ERROR” or “READ ERROR”: This indicates a trouble either in the CD or inside the player. The CD may be dirty, damaged or inserted up-side down.

“WAIT” or “PLEASE WAIT”: Operation has stopped due to a high temperature inside the player. Wait for a while and then press  or . Contact your Toyota dealer if the CD still cannot be played.

“NO MUSIC”: This indicates that the MP3/WMA file is not included in the CD.

n **Discs that can be used**

→P. 300

n **CD player protection feature**

→P. 300

n **If CDs are left inside the CD player or in the ejected position for extended periods**

→P. 300

3-2. Using the audio system

n **Lens cleaners**

→P. 300

n **MP3 and WMA files**

MP3 (MPEG Audio LAYER3) is a standard audio compression format.

Files can be compressed to approximately 1/10 of their original size by using MP3 compression.

WMA (Windows Media Audio) is a Microsoft audio compression format.

This format compresses audio data to a size smaller than that of the MP3 format.

There is a limit to the MP3 and WMA file standards and to the media/formats recorded by them that can be used.

l MP3 file compatibility

- Compatible standards
MP3 (MPEG1 LAYER3, MPEG2 LSF LAYER3)
- Compatible sampling frequencies
MPEG1 LAYER3: 32, 44.1, 48 (kHz)
MPEG2 LSF LAYER3: 16, 22.05, 24 (kHz)
- Compatible bit rates
MPEG1 LAYER3: 64, 80, 96, 112, 128, 160, 192, 224, 256, 320 (kbps)
MPEG2 LSF LAYER3: 64, 80, 96, 112, 128, 144, 160 (kbps)
* Compatible with VBR
- Compatible channel modes: stereo, joint stereo, dual channel and monaural

3

Interior features

3-2. Using the audio system

1 WMA file compatibility

- Compatible standards
WMA Ver. 7, 8, 9
- Compatible sampling frequencies
32, 44.1, 48 (kHz)
- Compatible bit rates (only compatible with 2-channel playback)
Ver. 7, 8: CBR 48, 64, 80, 96, 128, 160, 192 (kbps)
Ver. 9: CBR 48, 64, 80, 96, 128, 160, 192, 256, 320 (kbps)

1 Compatible media

Media that can be used for MP3 and WMA playback are CD-Rs and CD-RWs.

Playback in some instances may not be possible, depending on the status of the CD-R or CD-RW. Playback may not be possible or the audio may jump if the disc is scratched or marked with fingerprints.

1 Compatible disc formats

The following disc formats can be used.

- Disc formats: CD-ROM Mode 1 and Mode 2
CD-ROM XA Mode 2, Form 1 and Form 2
- File formats: ISO9660 Level 1, Level 2, (Romeo, Joliet)
MP3 and WMA files written in any format other than those listed above may not play correctly, and their file names and folder names may not be displayed correctly.

Items related to standards and limitations are as follows.

- Maximum directory hierarchy: 8 levels
- Maximum length of folder names/file names: 32 characters
- Maximum number of folders: 192 (including the root)
- Maximum number of files per disc: 255

3-2. Using the audio system

1 File names

The only files that can be recognized as MP3/WMA and played are those with the extension .mp3 or .wma.

1 Multi-sessions

As the audio system is compatible with multi-sessions, it is possible to play discs that contain MP3 and WMA files. However, only the first session can be played.

1 ID3 and WMA tags

ID3 tags can be added to MP3 files, making it possible to record the track title and artist name, etc.

The system is compatible with ID3 Ver. 1.0, 1.1, and Ver. 2.2, 2.3 ID3 tags. (The number of characters is based on ID3 Ver. 1.0 and 1.1.)

WMA tags can be added to WMA files, making it possible to record the track title and artist name in the same way as with ID3 tags.

1 MP3 and WMA playback

When a disc containing MP3 or WMA files is inserted, all files on the disc are first checked. Once the file check is finished, the first MP3 or WMA file is played. To make the file check finish more quickly, we recommend you do not write in any files other than MP3 or WMA files or create any unnecessary folders.

If the discs contain a mixture of music data and MP3 or WMA format data, only music data can be played.

3

Interior features

3-2. Using the audio system

1 Extensions

If the file extensions .mp3 and .wma are used for files other than MP3 and WMA files, they will be mistakenly recognized and played as MP3 and WMA files. This may result in large amounts of interference and damage to the speakers.

1 Playback

- To play MP3 file with steady sound quality, we recommend a fixed bit rate of 128 kbps and a sampling frequency of 44.1 kHz.
- CD-R or CD-RW playback may not be possible in some instances, depending on the characteristics of the disc.
- There is a wide variety of freeware and other encoding software for MP3 and WMA files on the market, and depending on the status of the encoding and the file format, poor sound quality or noise at the start of playback may result. In some cases, playback may not be possible at all.
- When files other than MP3 or WMA files are recorded on a disc, it may take more time to recognize the disc and in some cases, playback may not be possible at all.
- Microsoft, Windows, and Windows Media are the registered trademarks of Microsoft Corporation in the U.S. and other countries.

NOTICE

- n **CDs and adapters that cannot be used (→P. 301)**
- n **Player precautions (→P. 302)**

3-2. Using the audio system

Operating an iPod*

Connecting an iPod enables you to enjoy music from the vehicle speakers.

n Connecting an iPod

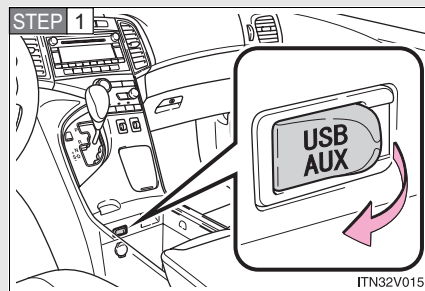

Open the cover and connect an iPod using an iPod cable.

Turn on the power of the iPod if it is not turned on.

STEP 2 Press .

n Control panel

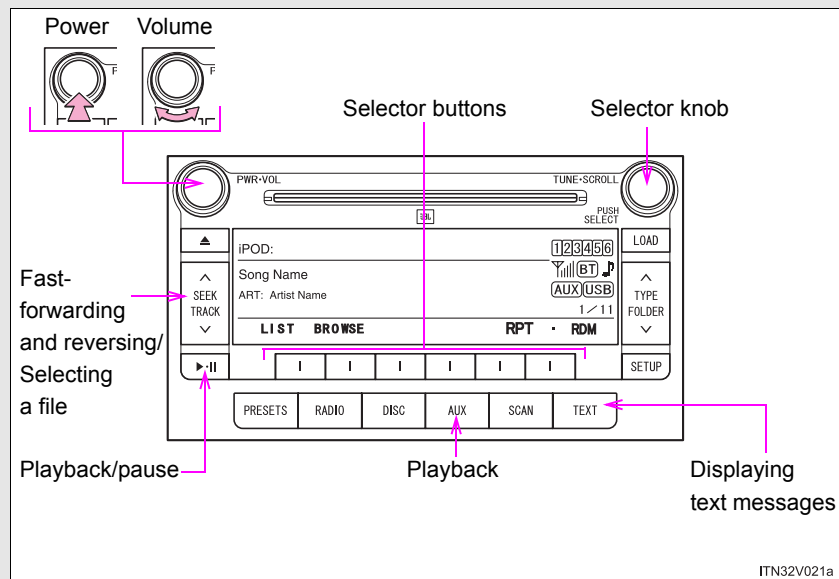

3

Interior features

*: If equipped

3-2. Using the audio system

Selecting a play mode

STEP 1 Press that corresponds to "BROWSE" to select iPod menu mode.

STEP 2 Press that corresponds to the desired play mode.

n Play mode list

Play mode	First selection	Second selection	Third selection	Fourth selection
PLIST	Playlists select	Songs select	-	-
ARTIST	Artists select	Albums select	Songs select	-
ALBUM	Albums select	Songs select	-	-
GENRE	Genre select	Artists select	Albums select	Songs select
SONGS	Songs select	-	-	-
PODCST	Albums select	Songs select	-	-
COMPSR	Composers select	Albums select	Songs select	-
BOOK	Songs select	-	-	-

Depending on the model, the name of your iPod may be displayed at the top of the list.

3-2. Using the audio system

Selecting songs from a song list



STEP 1 Press  that corresponds to "LIST".

The current playlist is displayed.

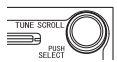
STEP 2 Turning  to select the desired song.

Press  returns the screen from list display to the previous screen.

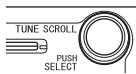
Selecting songs

Turn  or press "∧" or "∨" on  to select the desired song.

Playing and pausing songs

Press .

Fast-forwarding and rewinding songs

Press and hold "∧" or "∨" on .

3-2. Using the audio system

Shuffle playback

n Playing songs from one playlist or album in random order

Press  that corresponds to "RDM".

To cancel, press the button twice.

n Playing songs from all the playlists or albums in random order

Press  that corresponds to "RDM" twice.

To cancel, press the button again.

Repeat play

Press  that corresponds to "RPT".

To cancel, press the button again.

Even when the repeat play option has not been selected, playback will automatically continue from the first song in the current play list once the last song has ended.

Switching the display

Press .

Each time the button is pressed, the display changes in the following order: Track title → Track title/Artist name → Track title/Album name → Track title/Elapsed time.

3-2. Using the audio system

n **About iPod**

- l Apple is not responsible for the operation of this device or its compliance with safety and regulatory standards.
- l iPod is a trademark of Apple Inc., registered in the U.S. and other countries.

n **iPod functions**

- l When an iPod is connected and the audio source is changed to iPod mode, the iPod will resume play from the same point in which it was last used.
- l Depending on the iPod that is connected to the system, certain functions may not be available. Disconnecting the device and reconnecting it once again may resolve some malfunctions.

n **iPod problems**

To resolve most problems encountered when using your iPod, disconnect your iPod from the vehicle iPod connection and reset it. For instructions on how to reset your iPod, refer to your iPod Owner's Manual.

3

Interior features

3-2. Using the audio system

n Error messages

- “iPod ERROR”: This indicates a problem in the iPod, inside the USB box or the connection between them.
- “NO SONGS”: This indicates that there is no music data in the iPod.
- “UPDATE YOUR iPod”: This indicates that the version of the iPod is not compatible.

n Compatible models

Model	Generation	Software version
iPod	5th generation	Ver. 1.2.0 or higher
iPod nano	1st generation	Ver. 1.3.0 or higher
	2nd generation	Ver. 1.1.2 or higher
	3rd generation	Ver. 1.0.0 or higher
iPod touch	1st generation	Ver. 1.1.0 or higher
iPod classic	1st generation	Ver. 1.0.0 or higher

Depending on differences between models or software version etc., some models listed above might be incompatible with this system.

iPod 4th generation and earlier models are not compatible with this system.

iPhone, iPod mini, iPod shuffle and iPod photo are not compatible with this system.

Items related to standards and limitations are as follows:

- l Maximum number of lists in device: 9999
- l Maximum number of songs in device: 65,025
- l Maximum number of songs per list: 65,025

3-2. Using the audio system

CAUTION

n While driving

Do not connect iPod or operate the controls.

NOTICE

n To prevent damage to iPod

- !** Do not leave iPod in the vehicle. The temperature inside the vehicle may become high, resulting in damage to the player.
- !** Do not push down on or apply unnecessary pressure to the iPod while it is connected as this may damage the iPod or its terminal.
- !** Do not insert foreign objects into the port as this may damage the iPod or its terminal.

3

Interior features

3-2. Using the audio system Operating a USB memory*

Connecting a USB memory enables you to enjoy music from the vehicle speakers.

n Connecting a USB memory

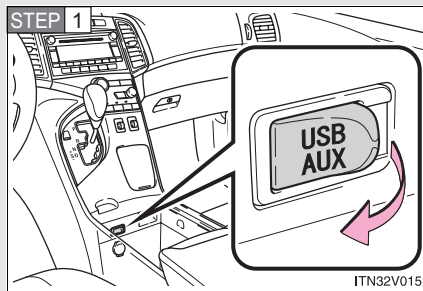

Open the cover and connect a USB memory.

Turn on the power of the USB memory if it is not turned on.

Depending on the USB device, a USB extension cable may be required in order to close the console box.

STEP 2 Press  .

n Control panel

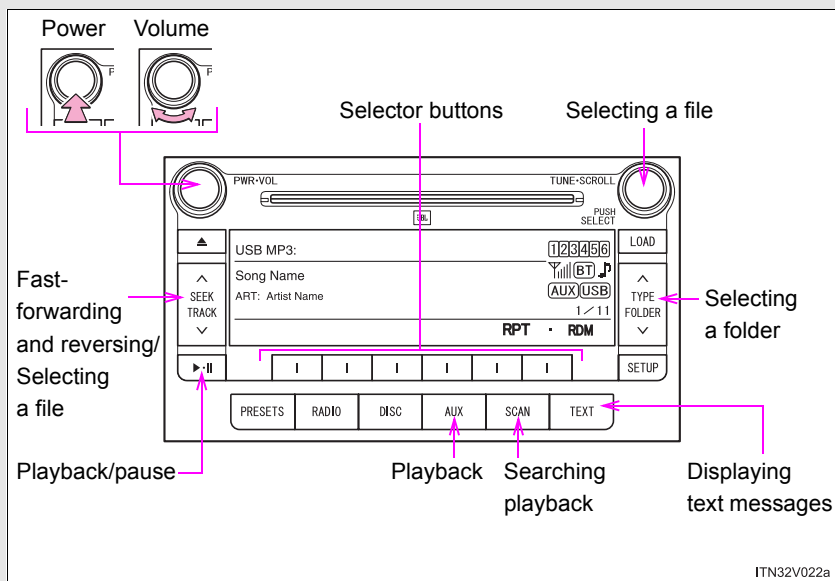

*: If equipped

3-2. Using the audio system

Selecting and scanning a folder

n Selecting folders one at a time

Press “^” or “v” on  to select the desired folder.

n Returning to the first folder

Press and hold “v” on  until you hear a beep.

n Scanning the first file of all the folders



STEP 1 Press and hold  until you hear a beep.

The first 10 seconds of the first file in each folder will be played.

STEP 2 When the desired folder is reached, press  again.

Selecting and scanning files

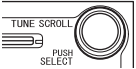
n Selecting a file

Turn  or press “^” or “v” on  to select the desired file.

n Scanning the files in a folder

Press .

The first 10 seconds of each file will be played.

To cancel, press  again.

When the desired file is reached, press  again.

3-2. Using the audio system

Playing and pausing files

Press  .

Fast-forwarding and rewinding files

Press and hold “^” or “v” on



Random playback

n Playing files from a folder in random order

Press  that corresponds to “RDM”.

To cancel, press the button twice.

n Playing all the files from a USB memory in random order

Press  that corresponds to “RDM” twice.

To cancel, press the button again.

Repeat play

n Repeating a file

Press  that corresponds to “RPT”.

To cancel, press the button twice.

n Repeating all the files in a folder

Press  that corresponds to “RPT” twice.

To cancel, press the button again.

3-2. Using the audio system

Switching the display

Press .

Each time the button is pressed, the display changes in the following order: Track title → Track title/Artist name → Track title/Album name → Track title/Elapsed time.

n When using the USB port

You may be unable to use the instrument panel power outlet if a device is connected to the USB port at the same time.

n USB memory functions

Depending on the USB memory that is connected to the system, certain functions may not be available. Disconnecting the device and reconnecting it once again may resolve some malfunctions.

n Error messages

“USB ERROR”: This indicates a problem either in the USB memory or inside the USB box or connection between them.

“NO MUSIC”: This indicates that no MP3/WMA files are included in the USB memory.

3

Interior features

3-2. Using the audio system

n **USB memory**

l Compatible devices

USB memory that can be used for MP3 and WMA playback

Depending on the type of USB device, playback may not be possible.

l Compatible device formats

The following device formats can be used:

- USB communication formats: USB2.0 FS (12mbps)
- File formats: FAT16/32 (Windows)
- Correspondence class: Mass storage class

MP3 and WMA files written in any format other than those listed above may not play correctly, and their file names and folder names may not be displayed correctly.

Items related to standards and limitations are as follows:

- Maximum directory hierarchy: 8 levels
- Maximum number of folders in a device: 999 (including the root)
- Maximum number of files in a device: 65025
- Maximum number of files per folder: 255

l MP3 and WMA files

MP3 (MPEG Audio LAYER 3) is a standard audio compression format.

Files can be compressed to approximately 1/10 of their original size using MP3 compression.

WMA (Windows Media Audio) is a Microsoft audio compression format.

This format compresses audio data to a size smaller than that of the MP3 format.

There is a limit to the MP3 and WMA file standards that can be used and to the media/formats on which the files are recorded.

3-2. Using the audio system

1 MP3 file compatibility

- Compatible standards
MP3 (MPEG1 AUDIO LAYERII, III, MPEG2 AUDIO LAYERII, III, MPEG2.5)
- Compatible sampling frequencies
MPEG1 AUDIO LAYERII, III: 32, 44.1, 48 (kHz)
MPEG2 AUDIO LAYERII, III: 16, 22.05, 24 (kHz)
MPEG2.5: 8, 11.025, 12 (kHz)
- Compatible bit rates (compatible with VBR)
MPEG1 AUDIO LAYERII, III: 32-320 (kbps)
MPEG2 AUDIO LAYERII, III: 32-160 (kbps)
MPEG2.5: 32-160 (kbps)
- Compatible channel modes: stereo, joint stereo, dual channel and monaural

1 WMA file compatibility

- Compatible standards
WMA Ver. 9
- Compatible sampling frequencies
HIGH PROFILE 32, 44.1, 48 (kHz)
- Compatible bit rates
HIGH PROFILE 32-320 (kbps, VBR)

1 File names

The only files that can be recognized as MP3/WMA and played are those with the extension .mp3 or .wma.

1 ID3 and WMA tags

ID3 tags can be added to MP3 files, making it possible to record the track title, artist name, etc.

The system is compatible with ID3 Ver. 1.0, 1.1, and Ver. 2.2, 2.3, 2.4 ID3 tags. (The number of characters is based on ID3 Ver. 1.0 and 1.1.)

WMA tags can be added to WMA files, making it possible to record the track title and artist name in the same way as with ID3 tags.

3

Interior features

3-2. Using the audio system

1 MP3 and WMA playback

- When a device containing MP3 or WMA files is connected, all files in the USB memory device are checked. Once the file check is finished, the first MP3 or WMA file is played. To make the file check finish more quickly, we recommend that you do not include any files other than MP3 or WMA files or create any unnecessary folders.
- When the USB device is connected and the audio source is changed to USB memory mode, the USB device will start playing the first file in the first folder. If the same device is removed and reinserted (and the contents have not been changed), the USB device will resume play from the same point in which it was last used.

1 Extensions

If the file extensions .mp3 and .wma are used for files other than MP3 and WMA files, they will be mistakenly recognized and played as MP3 and WMA files. This may result in large amounts of interference and damage to the speakers.

1 Playback

- To play MP3 files with steady sound quality, we recommend a fixed bit rate of at least 128 kbps and a sampling frequency of 44.1 kHz.
- There is a wide variety of freeware and other encoding software for MP3 and WMA files on the market, and depending on the status of the encoding and the file format, poor sound quality or noise at the start of playback may result. In some cases, playback may not be possible at all.
- Microsoft, Windows, and Windows Media are registered trademarks of Microsoft Corporation in the U.S.A. and other countries.

CAUTION

n While driving

Do not connect USB memory or operate the controls.

3-2. Using the audio system

 NOTICE

n To prevent damage to USB memory

- I** Do not leave USB memory in the vehicle. The temperature inside the vehicle may become high, resulting in damage to the player.
- I** Do not push down on or apply unnecessary pressure to the USB memory while it is connected as this may damage the USB memory or its terminal.
- I** Do not insert foreign objects into the port as this may damage the USB memory or its terminal.

3

Interior features

3-2. Using the audio system

Optimal use of the audio system

► Type A

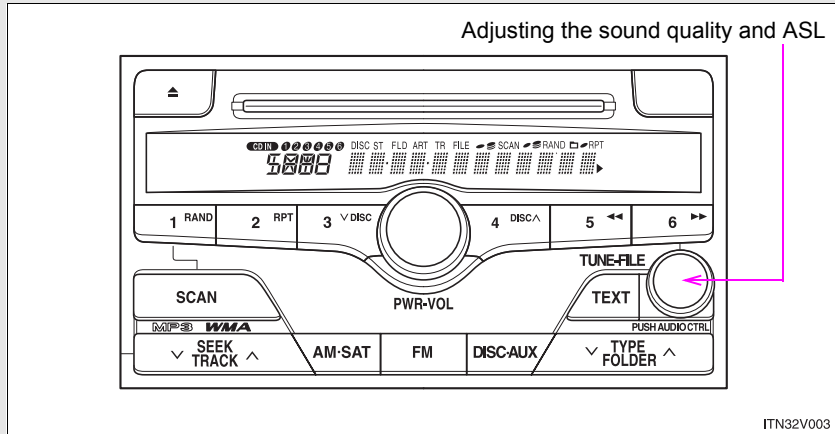

► Type B and C

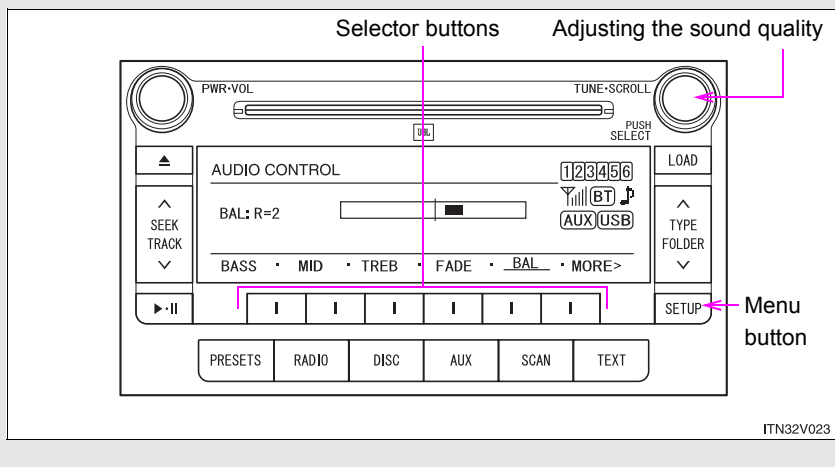

3-2. Using the audio system

Using the audio control function

n Changing modes

► Type A

Pressing  selects the mode to be change in the following order.

“BAS” → “MID” → “TRE” → “FAD” → “BAL” → “ASL”

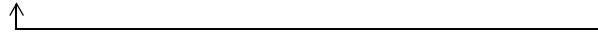

► Type B and C

STEP 1 Press  .

STEP 2 Press  that corresponds to the desired mode.

“BASS”, “MID” (type C only), “TREB”, “FADE” or “BAL”

3

Interior features

3-2. Using the audio system

n Adjusting sound quality

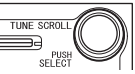
Turning  or  adjusts the level.
PUSH AUDIO CTRL PUSH SELECT

► Type A

Mode displayed	Sound quality mode	Level	Turn to the left	Turn to the right
BAS	Low-pitched tones*	-5 to 5	Low	High
MID	Mid-pitched tones*	-5 to 5		
TRE	High pitched tones*	-5 to 5		
FAD	Front/rear volume balance	F7 to R7	Shift to rear	Shift to front
BAL	Left/right volume balance	L7 to R7	Shift to left	Shift to right

*: The sound quality level is adjusted individually in each radio or CD mode.

► Type B and C

Mode displayed	Sound quality mode	Level	Turn to the left	Turn to the right
BASS	Bass*	-5 to 5	Low	High
MID	Mid-range* (type C only)	-5 to 5		
TREB	Treble*	-5 to 5		
FADE	Front/rear volume balance	F7 to R7	Shift to rear	Shift to front
BAL	Left/right volume balance	L7 to R7	Shift to left	Shift to right

*: The sound quality level is adjusted individually in each audio mode.

3-2. Using the audio system

n Adjusting the Automatic Sound Levelizer (ASL)

► Type A

When “ASL” is selected, turning  to the right changes the ASL level in the order of “LOW”, “MID” and “HIGH”.

Turning  to the left turns off the ASL.

ASL automatically adjusts the volume and tone quality according to vehicle speed.

► Type B and C

STEP 1 Press  .

STEP 2 Press  that corresponds to “MORE”.

STEP 3 Press  that corresponds to “ASL”.

STEP 4 Press  that corresponds to the desired mode.

Type B: “LOW”, “MID”, “HIGH” or “OFF”

Type C: “ON” or “OFF”

ASL automatically adjusts the volume and tone quality according to vehicle speed.

n Changing the JBL Synthesis surround sound (Type B and C)

STEP 1 Press  .

STEP 2 Press  that corresponds to “MORE”.

STEP 3 Press  that corresponds to “SYNTH”.

STEP 4 Press  that corresponds to “ON” or “OFF”.

3-2. Using the audio system

n Setting the number of preset pages (type B and C)

The number of preset pages desired can be set from 1 to 6. The initial setting is 6 pages.

STEP 1 Press  .

STEP 2 Press  that corresponds to "MORE".

STEP 3 Press  that corresponds to "PRESET".

STEP 4 Press  that corresponds to the desired number of preset pages.

This menu may also be reached directly by pressing and holding  .

n Language settings (type B and C)

→P. 282

3-2. Using the audio system Using the AUX port

This adapter can be used to connect a portable audio device and listen to it using the vehicle's speakers.

STEP 1 Open the cover and connect the portable audio device.

► Type A

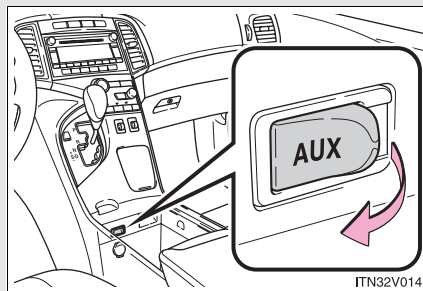

► Type B

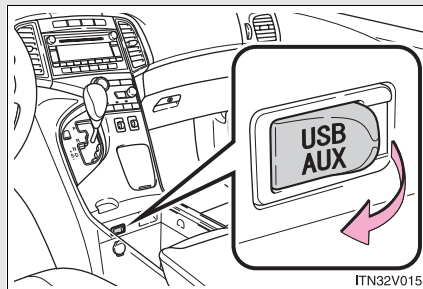

STEP 2 Press **DISC-AUX** or **AUX**.

3

Interior features

n Operating portable audio devices connected to the audio system

The volume can be adjusted using the vehicle's audio controls. All other adjustments must be made on the portable audio device itself.

n Cable pass-through

→P. 444

3-2. Using the audio system

Using the steering switches

Some audio features can be controlled using the switches on the steering wheel.

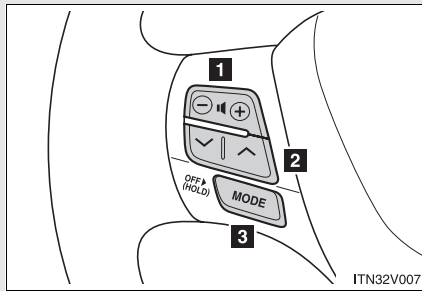

1 Increases/decreases volume

2 Radio mode:
Selects radio stations

CD mode:
Selects tracks files (MP3 and WMA) and discs

iPod mode:
Selects a song

USB memory mode:
Selects a file and folder

Bluetooth® audio mode:
Selects a track and album

RSE mode:
Selects track/file and chapter

3 Turns the power on, selects an audio source

3-2. Using the audio system

Turning on the power

Press  when the audio system is turned off.

The audio system can be turned off by holding the switch down until you hear a beep.

Changing the audio source

Press  when the audio system is turned on. The audio source changes as follows each time the button is pressed. If a CD is not inserted, that mode will be skipped.

Type A

FM (1, 2) → CD player → RSE* → AUX → AM → SAT (1, 2, 3)



Type B and C

FM → SAT → CD → CD changer (type C only) → RSE* →
USB/iPod → AUX → Bluetooth® audio → AM

*: If equipped

3

Interior features

Adjusting the volume

Press "+" on  to increase the volume and "-" to decrease the volume.

Press and hold the switch to continue increasing or decreasing the volume.

3-2. Using the audio system

Selecting a radio station

STEP 1 Press  to select the radio mode.

STEP 2 Press “^” or “v” on  to select a preset station.

To scan for receivable stations, press and hold the switch until you hear a beep.

Selecting a track/file or song

STEP 1 Press  to select the CD, iPod, USB memory, Bluetooth® audio or RSE mode.

STEP 2 Press “^” or “v” on  to select the desired track/file or folder.

Selecting a folder or album

STEP 1 Press  to select the CD, USB memory or Bluetooth® audio mode.

STEP 2 Press and hold “^” or “v” on  until you hear a beep.

3-2. Using the audio system

Selecting a disc in the CD player (with a CD changer)

STEP 1 Press  to select the CD mode.

STEP 2 Press and hold “^” or “v” on  until you hear a beep.

Selecting a track/file or chapter (vehicles with rear seat entertainment system)

STEP 1 Press  to select the RSE mode.

STEP 2 Press “^” or “v” on  to select the desired track/file or chapter.

CAUTION

n To reduce the risk of an accident

Exercise care when operating the audio switches on the steering wheel.

3

Interior features

3-3. Using the Bluetooth® audio system

Bluetooth® audio system*

The Bluetooth® audio system enables you to enjoy music played on a portable digital audio player (portable player) from the vehicle speakers via wireless communication.

This audio system supports Bluetooth®, a wireless data system capable of playing portable audio music without cables. If your portable player does not support Bluetooth®, the Bluetooth® audio system will not function.

▶ Vehicles with a navigation system

Owners of models equipped with a navigation system should refer to the “Navigation System Owner’s Manual”.

▶ Vehicles without a navigation system

Title	Page
Using the Bluetooth® audio system	P. 341
Operating a Bluetooth® enabled portable player	P. 348
Setting up a Bluetooth® enabled portable player	P. 350
Bluetooth® audio system setup	P. 355

■ Conditions under which the system will not operate

- If using a portable player that does not support Bluetooth®
- If the portable player is switched off
- If the portable player is not connected
- If the portable player’s battery is low
- If the portable player is behind the seat or in the glove box or console box
- If metal is covering or touching the portable player

*: If equipped

■ When transferring ownership of the vehicle

Be sure to initialize the system to prevent personal data from being improperly accessed. (→P. 419)

■ About Bluetooth®



Bluetooth is a registered trademark of Bluetooth SIG. Inc.

■ Compatible models

- Bluetooth® specifications:
Ver. 1.2, or higher (Recommended: Ver. 2.0+EDR or higher)
- Following Profiles:
 - A2DP (Advanced Audio Distribution Profile) Ver. 1.0 or higher
 - AVRCP (Audio/Video Remote Control Profile) Ver. 1.0 or higher (Ver. 1.3 or higher recommended)

Portable players must correspond to the above specifications in order to be connected to the Bluetooth® audio system. However, please note that some functions may be limited depending on the type of portable player.

■ Certification for the Bluetooth® audio system

FCC ID: ACJ932C5ZZZ035

IC ID: 216J-C5ZZZ035

MADE IN MEXICO

This device complies with Part 15 of the FCC Rules and RSS-210 Rules. Operation is subject to the following two conditions: (1) This device may not cause harmful interference, and (2) This device must accept any interference received, including interference that may cause undesired operation.

 **CAUTION**

■ **FCC WARNING**

Changes or modifications in construction not expressly approved by the party responsible for compliance could void the user's authority to operate the equipment.

Radio frequency exposure. This device is approved for Mobile Application only and, to comply with applicable FCC radio frequency exposure regulations, must be used with a distance of at least 7.9 in. (20 cm) between the antenna and the body of any person at all time during use.

■ **While driving**

Do not connect portable players or operate the controls.

 **NOTICE**

■ **To prevent damage to portable players**

Do not leave portable players in the vehicle. The temperature inside the vehicle may become high, resulting in damage to the player.

■ Steering wheel

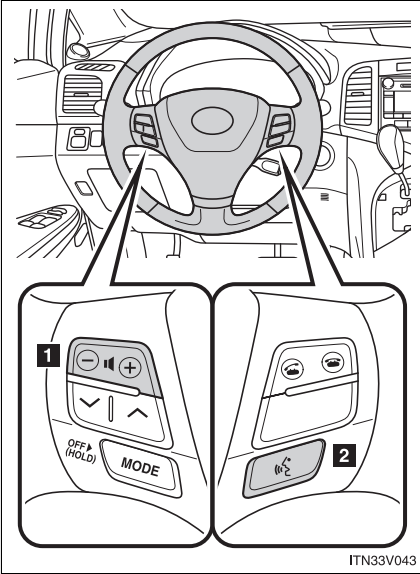

1 Volume

The voice guidance volume cannot be adjusted by using this button.

2 Talk switch

Turns the voice command system on (press)/turns the voice command system off (press and hold)

■ Microphone

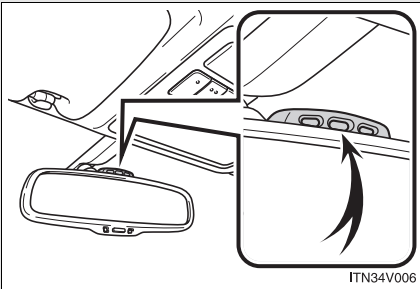

Operating the system using voice commands

By following voice guidance instructions output from the speaker, voice commands enable the operation of the Bluetooth® audio system without the need to check the display or operate

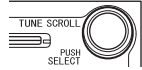

■ Operation procedure when using voice commands

Press the talk switch and follow voice guidance instructions.

■ Auxiliary commands when using voice commands

The following auxiliary commands can be used when operating the system using a voice command:

“Cancel”: Exits the Bluetooth® audio system

“Repeat”: Repeats the previous voice guidance instruction

“Go back”: Returns to the previous procedure

“Help”: Reads aloud the function summary if a help comment is registered for the selected function

Using the Bluetooth® audio system for the first time

Before using the Bluetooth® audio system, it is necessary to register a Bluetooth® enabled portable player in the system. Follow the procedure below to register (pair) a portable player:

STEP 1 Press  until “BT AUDIO” is displayed.

STEP 2 Press  that corresponds to “SETUP”.

The introductory guidance and portable player name registration instructions are heard.

STEP 3 Select “Pair Audio Player” using a voice command or

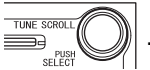

STEP 4 Register a portable player name by either of the following methods:

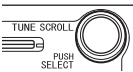
a. Select “Record Name” using , and say the name to be registered.

b. Press the talk switch and say the name to be registered.

A voice guidance instruction to confirm the input is heard.

STEP 5 Select “Confirm” using a voice command or  .

A passkey is displayed and heard, and a voice guidance instruction for inputting the passkey into the portable player is heard.

STEP 6 Input the passkey into the portable player.

Refer to the manual that comes with the portable player for the operation of the portable player.

Guidance for registration completion is heard.

If the portable player has a Bluetooth® phone, the phone can be registered at the same time. (→P. 397)

Menu list of the Bluetooth® audio system

■ Normal operation

First menu	Second menu	Third menu	Operation detail
"Setup"	"BT•A Setup"	"Pair Audio Player"	Registering a portable player
		"Select Audio Player"	Selecting a portable player to be used
		"Change Name"	Changing the registered name of a portable player
		"List Audio Players"	Listing the registered portable players
		"Set Passkey"	Changing the passkey
		"Delete Audio"	Deleting a registered portable player
	"System Setup"	"Guidance Volume"	Setting voice guidance volume
		"Device Name"	Displaying the Bluetooth® device address and name
		"Initialize"	Initializing the system

"BT•A Setup" can be canceled by pressing the on-hook switch or saying the voice command, "Cancel".

■ When using a voice command

For numbers, say a combination of single digits from zero to nine.

Say the command correctly and clearly.

■ Situations that the system may not recognize your voice

- When driving on rough roads
- When driving at high speeds
- When air is blowing out of the vents onto the microphone
- When the air conditioning fan emits a loud noise

■ Operations that cannot be performed while driving

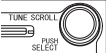
- Operating the system with 
- Registering a portable player to the system

■ Changing the passkey

→P. 353

3-3. Using the Bluetooth® audio system

Operating a Bluetooth® enabled portable player*

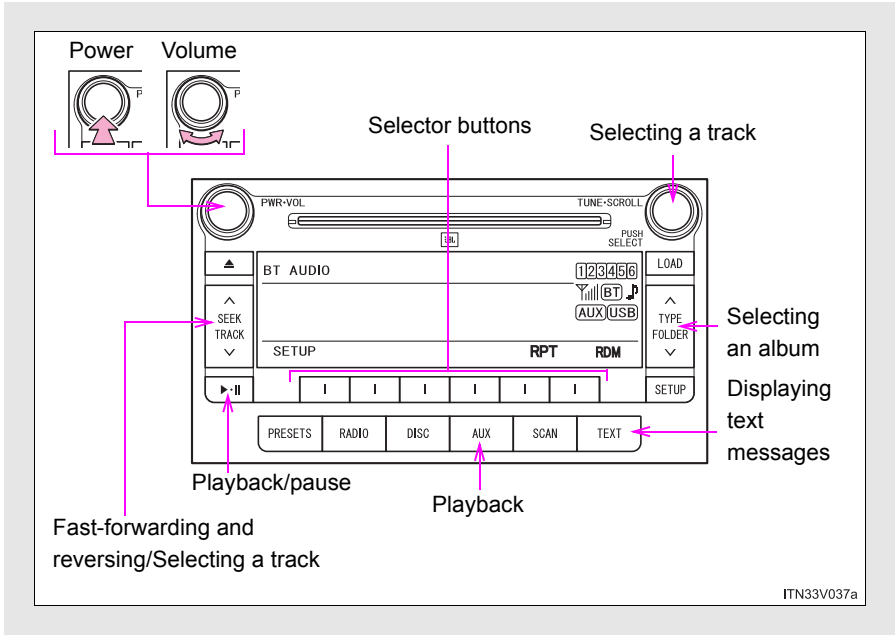

Selecting an album

Press “v” or “^” on



Selecting tracks

Turn

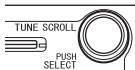

or press “^” or “v” on



to select the desired

track.

*: If equipped

Playing and pausing tracks

Press  .

Fast-forwarding and rewinding tracks

Press and hold “^” or “v” on  .

Switching the display

Press  .

Each time the button is pressed, the display changes in the following order: Track title → Track title/Artist name → Track title/Album name → Track title/Elapsed time.

Using the steering switches

→P. 334

■ Bluetooth® audio system functions

Depending on the portable player that is connected to the system, certain functions may not be available.

■ Error messages

“BT Audio Error”: This indicates a problem in the system.

3-3. Using the Bluetooth® audio system

Setting up a Bluetooth® enabled portable player*

Registering a portable player in the Bluetooth® audio system allows the system to function. The following functions can be used for registered portable players:

■ Functions and operation procedures

STEP 1 Press  until “BT AUDIO” is displayed.

STEP 2 Press  that corresponds to “SETUP”.

STEP 3 Select one of the following functions using a voice com-

mand or



- Registering a portable player
“Pair Audio Player”
- Selecting a portable player to be used
“Select Audio Player”
- Changing the registered name
“Change Name”
- Listing the registered portable players
“List Audio Players”
- Changing the passkey
“Set Passkey”
- Deleting a registered portable player
“Delete Audio Player (Delete Audio)”

*: If equipped

Registering a portable player

Select “Pair Audio Player” using a voice command or , and perform the procedure for registering a portable player. (→P. 344)

Selecting a portable player to be used

STEP 1 Select “Select Audio Player” using a voice command or

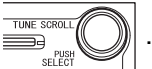

STEP 2 Select the portable player to be used by either of the following methods, and select “Confirm” by using a voice command or

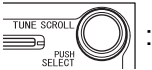

- Press the talk switch and say the name of the desired portable player.
- Press the talk switch and say “List Audio Players”. When the name of the desired portable player is read aloud, press the talk switch.

STEP 3 Press the talk switch and say “From Car” or “From Audio”, and

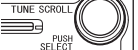
select “Confirm” by using a voice command or .

Vehicles with smart key system: If “From Car” is selected, the portable player will be automatically connected whenever the “ENGINE START STOP” switch is in either ACCESSORY or IGNITION ON mode.

Vehicles without smart key system: If “From Car” is selected, the portable player will be automatically connected whenever the engine switch is in either “ACC” or “ON” position.

Changing the registered name of a portable player

STEP 1 Select “Change Name” using a voice command or



STEP 2 Select the name of the portable player to be changed by either of the following methods, and select “Confirm” using a

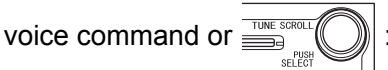

- voice command or
- Press the talk switch and say the name of desired portable player.
 - Press the talk switch and say “List Audio Players”. When the name of the desired portable player is read aloud, press the talk switch.

STEP 3 Press the talk switch or select “Record Name” using

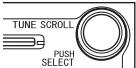

, and say the new name.

STEP 4 Select “Confirm” using a voice command or

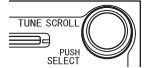

Listing the registered portable players

Select “List Audio Players” using a voice command or  .

The list of registered portable players will be read aloud.

When listing is complete, the system returns to “BT•A Setup”.

Pressing the talk switch while the name of a portable player is being read aloud selects the portable player, and the following functions will become available:

- Selecting a portable player: “Select Audio Player”
- Changing a registered name: “Change Name”
- Deleting a portable player: “Delete Audio Player (Delete Audio)”

Changing the passkey

STEP 1 Select “Set Passkey” using a voice command or  .

STEP 2 Press the talk switch, say a 4 to 8-digit number, and select

“Confirm” using a voice command or  .

STEP 3 When the entire number to be registered as a passkey has

been input, press  again.

If the number to be registered has 8 digits, pressing of the knob is not necessary.

Deleting a registered portable player

STEP 1 Select “Delete Audio Player (Delete Audio)” using a voice command or

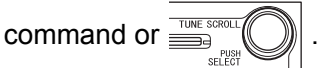

command or

STEP 2 Select the portable player to be deleted by either of the following methods and select “Confirm” using a voice command or

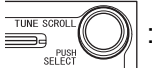

- a. Press the talk switch and say the name of the desired portable player.
- b. Press the talk switch and say “List Audio Players”. When the name of the desired portable player is read aloud, press the talk switch.

If the portable player to be deleted is paired as a Bluetooth® phone, the registration of the mobile phone can be deleted at the same time. A voice guidance instruction to delete a mobile phone is heard.

STEP 3 Select “Confirm” by using a voice command or

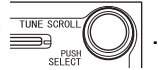

■ The number of portable players that can be registered

Up to 2 portable players can be registered in the system.

3-3. Using the Bluetooth® audio system

Bluetooth® audio system setup*

■ System setup items and operation procedures

→P. 416

*: If equipped

3-4. Using the rear seat entertainment system

Rear seat entertainment system features*

The rear seat entertainment system is designed for the rear passengers to enjoy audio and DVD video separately from the front audio system.

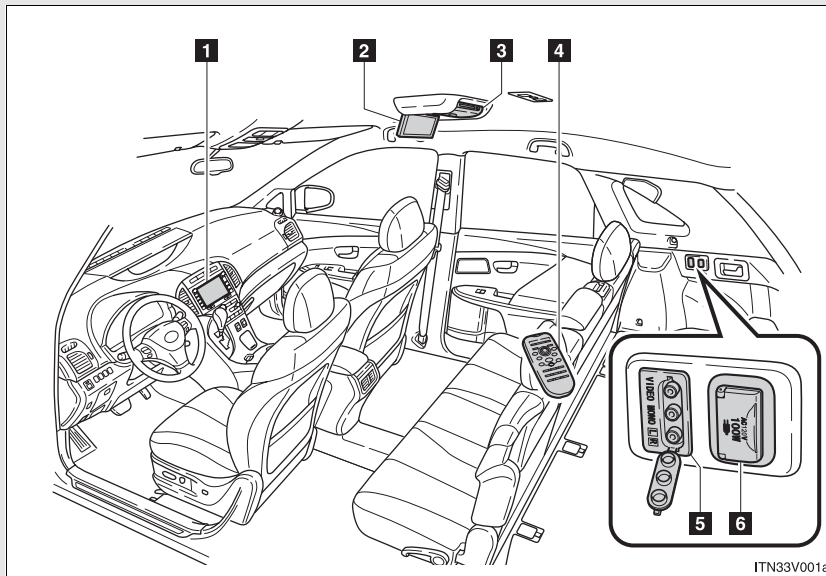

- 1 Front audio system
- 2 Display
- 3 DVD player
- 4 Rear seat entertainment system controller
- 5 A/V input port
- 6 Power outlet

*: If equipped

3-4. Using the rear seat entertainment system

Opening and closing the display

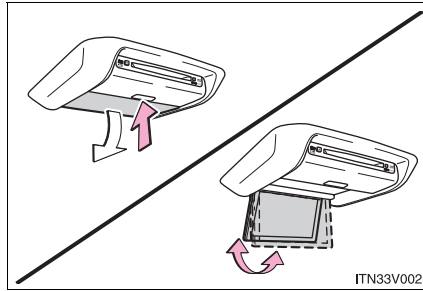

Press the lock release button to open the display.

Pull the display down to an easily viewable angle (between 90° and 125°).

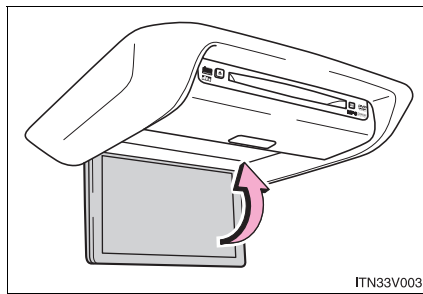

To close the display, push the display up until a click is heard.

The illumination of the screen is automatically turned off when the display is closed. However, the rear seat entertainment system is not turned off.

3

Interior features

Loading a disc

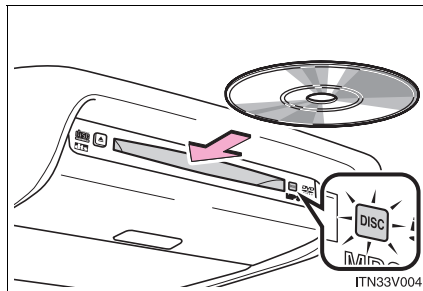

Insert the disc into the slot with the label side up.

The "DISC" indicator light turns on while the disc is loaded.

The player will play the track or chapter, and will repeat it after it reaches the end.

3-4. Using the rear seat entertainment system

Ejecting a disc

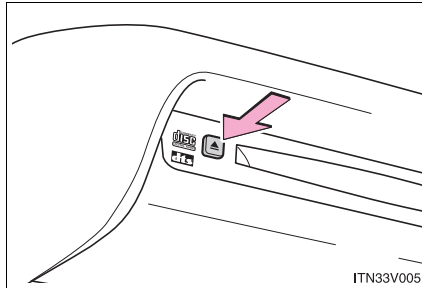

Press  and remove the disc.

Turning the rear seat entertainment system power on/off

n Operating from the front audio system

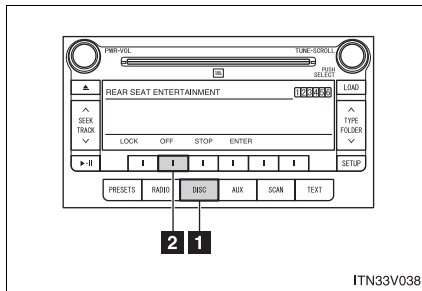

1 Selecting either the front audio system or DVD player audio for the speakers

2 Press  that corresponds to “OFF”, to turn off the rear seat entertainment system.

Press  that corresponds to “ON”, to turn on the rear seat entertainment system.

3-4. Using the rear seat entertainment system

Setting the rear seat entertainment system lock

► Front audio system

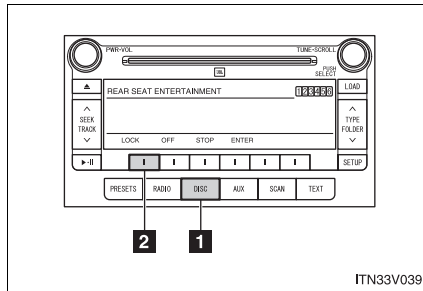

- 1** Selecting either the front audio system or DVD player audio for the speakers
- 2** Selecting “LOCK” or “UNLOCK” for the rear seat entertainment system

The rear seat entertainment system lock remains on, even when the engine switch is turned off.

► DVD player display

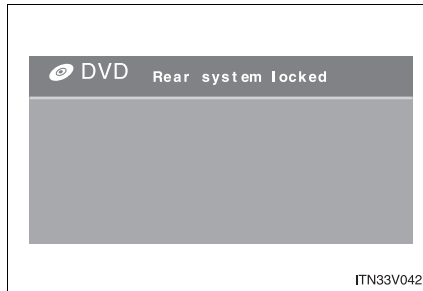

3

Interior features

3-4. Using the rear seat entertainment system

n **The rear seat entertainment system can be used when**

▶ Vehicles with smart key system

The “ENGINE START STOP” switch is in ACCESSORY or IGNITION ON mode.

▶ Vehicles without smart key system

The engine switch is in the “ACC” or “ON” position.

n **Discs that can be used**

Discs with the marks shown below can be used.

Playback may not be possible depending on recording format or disc features, or due to scratches, dirt or deterioration.



n **When appears on the screen**

It indicates that the selected icon cannot be used at this time.

n **If a disc is removed from the front audio system while the rear seat entertainment system is in use**

The rear seat entertainment system will be turned off.

n **Error messages**

DISC CHECK: Indicates that the disc is dirty, damaged or was inserted upside down. Clean the disc or insert it correctly.

REGION CODE ERROR: Indicates that the DVD region code is not set properly.

DVD ERROR: Indicates that there is a problem inside the player. Eject the disc. Set the disc again.

If the malfunction still exists, take the vehicle to your Toyota dealer.

3-4. Using the rear seat entertainment system

n Before using the controller (for new vehicle owners)

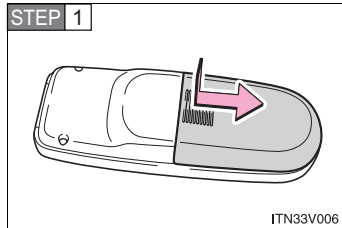

Remove the cover.

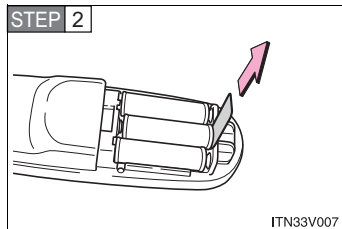

Remove the insulating sheet.

n When the controller batteries are fully depleted

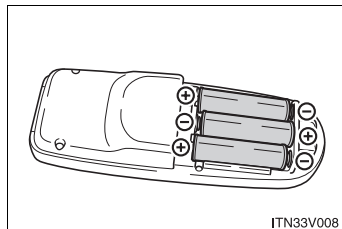

Remove the depleted batteries and install new 3 AA batteries.

3

Interior features

3-4. Using the rear seat entertainment system

n **If the remote controller batteries are discharged**

The following symptoms may occur.

- l The rear seat entertainment system controller will not function properly.
- l The operational range is reduced.

n **When using AA batteries**

Batteries can be purchased at your Toyota dealer, electric appliance shop, or camera stores.

Replace only with the same or equivalent type recommended by a Toyota dealer.

Dispose of used batteries according to the local laws.

n **Headphones**

With some headphones generally available in the market, it may be difficult to catch signals properly. Toyota recommends the use of Toyota genuine wireless headphones.

Contact your Toyota dealer for further details.

n **Volume**

- l Adjust the volume when you use the headphones. Loud sounds may have a significant impact on the human body.
- l Conversational speech on some DVDs is recorded at a low volume to emphasize the impact of sound effects. If you adjust the volume assuming that the conversations represent the maximum volume level that the DVD will play, you may be startled by louder sound effects or when you change to a different audio source. Be sure to adjust the volume with this in mind.

3-4. Using the rear seat entertainment system

CAUTION

n When the rear seat entertainment system is not used

Keep the display closed.

In the event of an accident or sudden braking, an occupant may hit the opened display, resulting in injury.

n To prevent accidents and electric shock

Do not disassemble or modify the remote controller.

n When the remote controller is not used

Stow the remote controller.

Injuries may result in the event of an accident or sudden braking.

n Removed battery and other parts

Keep away from children. These parts are small and if swallowed by a child they can cause choking. Failure to do so could result in death or serious injury.

n DVD video precaution

Conversational speech on some DVDs is recorded at a low volume to emphasize the impact of sound effects. If you adjust the volume assuming that the conversations represent the maximum volume level that the DVD will play, you may be startled by louder sound effects or when you change to a different audio source.

Loud sounds may have a significant impact on the human body or pose a driving hazard. Keep this in mind when you adjust the volume.

3

Interior features

3-4. Using the rear seat entertainment system

NOTICE

n Cleaning the display

Wipe the display with a dry soft cloth.

If the screen is wiped with a rough cloth, the surface of the screen may be scratched.

n To prevent damage to the remote controller

! Keep the remote controller away from direct sunlight, high temperature and high humidity.

! Do not drop or knock the remote controller against hard objects.

! Do not sit on or place heavy objects on the remote controller.

n Discs and adapters that cannot be used

→P. 301

n Player precautions

Failure to follow the precautions below may result in damage to the discs or the player itself.

! Do not insert anything other than discs into the disc slot.

! Do not apply oil to the player.

! Store discs away from direct sunlight.

! Never try to disassemble any part of the player.

n For normal operation after replacing the battery

Observe the following precautions to prevent accidents.

! Always work with dry hands.

Moisture may cause the battery to rust.

! Do not touch or move any other components inside the remote control.

! Do not bend either of the battery terminals.

3-4. Using the rear seat entertainment system Using the DVD player (DVD video)

n Controller

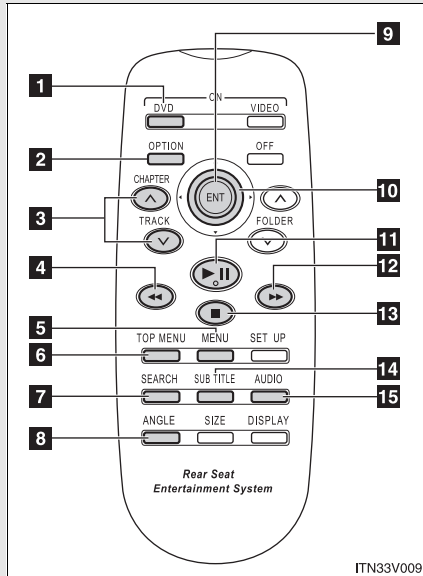

- 1** Turning on the DVD mode
- 2** Turning on or off the operation switches (icon) on the display
- 3** Selecting a chapter
- 4** Reversing a disc
- 5** Turning on the menu screen
- 6** Turning on the title selection screen
- 7** Searching the title
- 8** Changing the screen angle
- 9** Inputting the selected switch (icon)
- 10** Selecting a switch (icon)
- 11** Playing/pausing a disc
- 12** Fast forwarding a disc
- 13** Stopping a disc
- 14** Changing the subtitle language
- 15** Changing the audio language

3-4. Using the rear seat entertainment system

n **Display (page 1)**

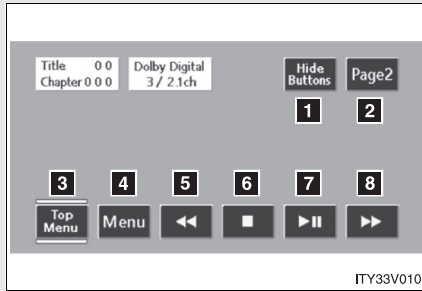

- 1** Turning off the operation switches (icon) on the display
- 2** Displaying page 2
- 3** Turning on or off the title selection screen for the disc
- 4** Turning on or off the menu screen for the disc
- 5** Reversing a disc
- 6** Stopping a disc
- 7** Pausing the disc/canceling the pause
- 8** Fast forwarding a disc

n **Display (page 2)**

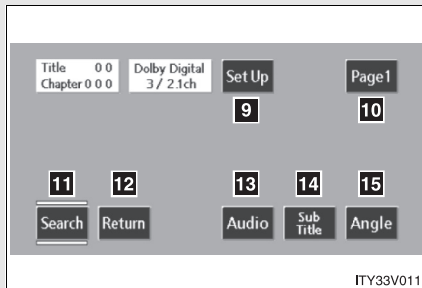

- 9** Displaying the initial setting screen
- 10** Displaying page 1
- 11** Search for a title
- 12** Returning to the previous screen
- 13** Changing the audio language
- 14** Changing the subtitle language
- 15** Changing the angle

3-4. Using the rear seat entertainment system

Operating from the front audio system

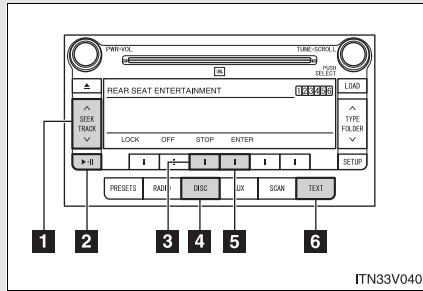

- 1** Press: Selecting a chapter
Press and hold: Fast-forwarding/rewinding a disc
- 2** Playing/pausing a disc
- 3** Stopping/playing a disc
- 4** Selecting the DVD mode
- 5** Starting a disc
- 6** Displaying an elapsed time

Turning on or off the operation switches

Press to turn on the operation switches.

Press once again or select to turn off the operation switches.

Turning on the title selection screen

Press or select to turn on the title selection screen. For the operation of the title selection screen, see the separate manual for the DVD disc.

Turning on the menu screen

Press or select to turn on the menu screen. For the operation of the menu screen, see the separate manual for the DVD disc.

3

Interior features

3-4. Using the rear seat entertainment system

Returning to the previous screen

Select **Return** to return to the previous screen. For the operation of the menu screen, see the separate manual for the DVD disc.

Searching for a title

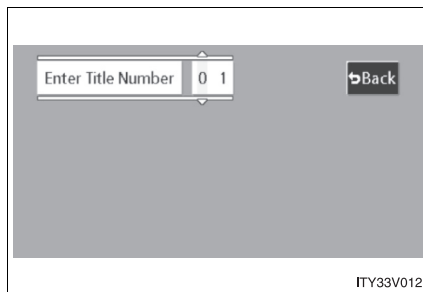

Press **SEARCH** or select **Search** to display the screen to search for a title.

Select the title number, and press **ENT** to input it.

Select **Back** to return to the previous screen.

Changing the subtitle language

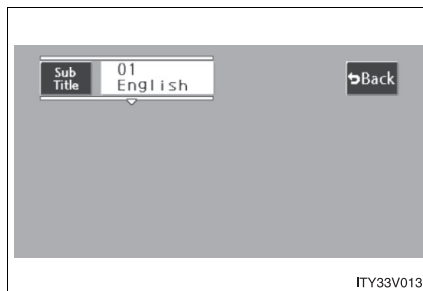

Press **SUB TITLE** or select **Sub Title** to display the subtitle language screen.

Each time **SUB TITLE** is pressed or **Back** is selected, another language stored on the disc is selected.

Select **Back** to return to the previous screen.

3-4. Using the rear seat entertainment system

Changing the audio language

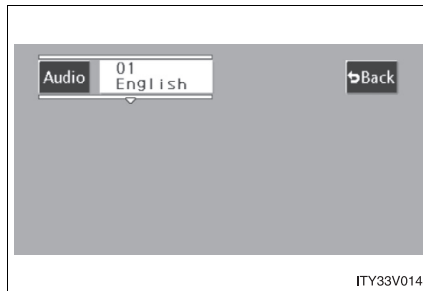



Press  or select **Audio** to display the audio language screen.

Each time  is pressed or **Audio** is selected, another language stored on the disc is selected.

Select  to return to the previous screen.

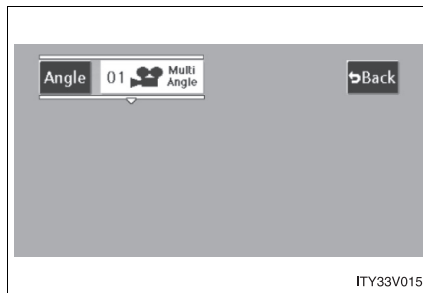
Changing the angle



Press  or select **Angle** to display the screen to change the angle.

Each time  is pressed or **Angle** is selected, the angle changes.

Select  to return to the previous screen.

3

Interior features

n DVD player and DVD video discs





This DVD player is compatible NTSC color TV formats. DVD video discs conforming to other formats such as PAL or SECAM cannot be used.

3-4. Using the rear seat entertainment system

n **Region codes**

Some DVD video discs have a region code indicating where you can use them. If the DVD video disc is not labeled "ALL" or "1", you cannot use it in this DVD player. If you attempt to play an inappropriate DVD video disc in this player, "REGION CODE ERROR" appears on the screen. Even if the DVD video disc does not have a region code, in some cases you cannot use it.

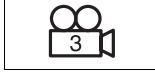
n **Symbols shown on DVD video discs**

Symbol	Meaning
	Indicates NTSC format.
	Indicates the number of audio tracks.
	Indicates the number of language subtitles.
	Indicates the number of angles.
	Indicates the screen display ratios available. Wide screen: 16:9 Standard: 4:3
	Indicates the disc's region code. ALL: in all countries Number: region code

3-4. Using the rear seat entertainment system

n DVD video disc information

1 DVD video discs

Digital Versatile Disc that holds video. DVD video discs have adopted "MPEG2", one of the world standards of digital compression technologies. The picture data is compressed by 1/40 on average and stored. Variable rate encoding technology in which the volume of data assigned to the picture is changed depending on the picture format has also been adopted. Audio data is stored using PCM and Dolby digital, which enables higher quality of sound. Furthermore, multi-angle and multi-language features will also help you enjoy the more advanced technology of DVD video.

3

Interior features

3-4. Using the rear seat entertainment system

1 Viewer restrictions

This feature limits what can be viewed in conformity with the level of restrictions of the country. The level of restrictions varies depending on the DVD video disc. Some DVD video discs cannot be played at all, or violent scenes are skipped or replaced with other scenes.

Level 1: DVD video discs for children can be played.

Level 2-7: DVD video discs for children and G-rated movies can be played.

Level 8: All types of DVD video discs can be played.

1 Multi-angle option

You can enjoy the same scene from different angles.

1 Multi-language option

You can select the subtitle and audio languages.

1 Region codes

The region codes are found on DVD players and DVD discs. If a DVD video disc does not have the same region code as the DVD player, you cannot play the disc on that DVD player. (→P. 370)

1 Audio

This DVD player can play linear PCM, Dolby Digital and MPEG audio format DVD. Other decoded types cannot be played.

1 Title and chapter

Video and audio programs stored in DVD video discs are divided into parts by title and chapter.

Title: The largest unit of the video and audio programs stored on DVD video discs. Usually, one movie, one album, or one audio program is assigned as a title.

Chapter: A title is comprised of one or more chapters.

3-4. Using the rear seat entertainment system

n **Sound**

l **Dolby Digital**

Manufactured under license from Dolby Laboratories.

“Dolby” and the double-D symbol are trademarks of Dolby Laboratories.

Confidential unpublished works.

©1992-1997 Dolby Laboratories. All rights reserved.

l **DTS**

“DTS” and “DTS Digital Surround” are registered trademarks of Digital Theater System, Inc.

n **MP3 and WMA files**

→P. 309

3

Interior features

373

3-4. Using the rear seat entertainment system Using the DVD player (video CD)

n Controller

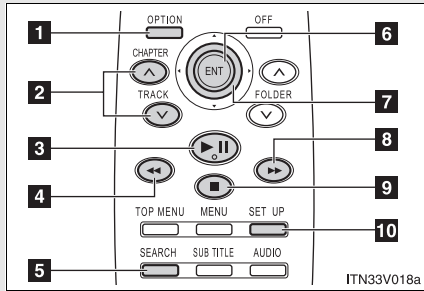

- 1 Turning on or off the operation switches (icon) on the display
- 2 Selecting a chapter
- 3 Playing/pausing a disc
- 4 Reversing a disc
- 5 Displaying operation switches (icon)
- 6 Inputting the selected switch (icon)
- 7 Selecting a switch (icon)
- 8 Fast forwarding a disc
- 9 Stopping a disc
- 10 Changing the initial setting

3-4. Using the rear seat entertainment system

n Display (page 1)

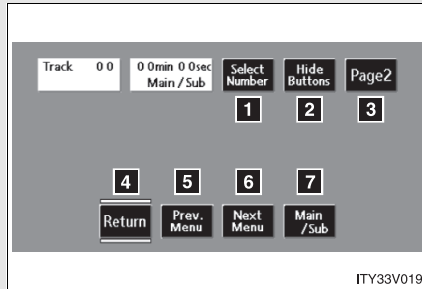

- 1** Selecting a disc menu number
- 2** Turning off the menu screen
- 3** Displaying page 2
- 4** Turning on the disc menu
- 5** Returning to the previous page screen (with the disc menu displayed)
- 6** Proceeding to the next page screen (with the disc menu displayed)
- 7** Changing to a multiplex transmission

n Display (page 2)

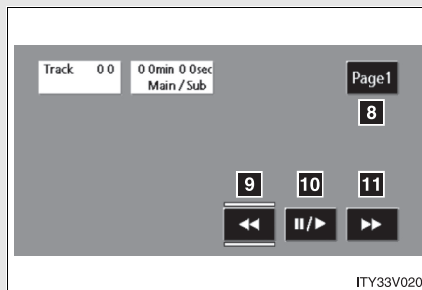

- 8** Displaying page 1
- 9** Reversing a disc
- 10** Pausing the disc/canceling the pause
- 11** Fast forwarding a disc

3

Interior features

3-4. Using the rear seat entertainment system

n Operating from the front audio system

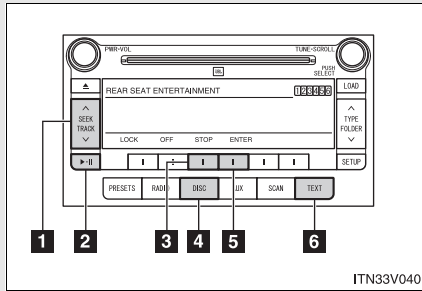

- 1** Press: Selecting a chapter
- Press and hold: Fast-forwarding/rewinding a disc
- 2** Playing/pausing a disc
- 3** Stopping/playing a disc
- 4** Selecting the DVD mode
- 5** Starting a disc
- 6** Displaying a elapsed time

Selecting a disc menu number

Select **Select Number** to display the disc menu number search screen.

Select the disc menu number, and press **ENT** to input it.

Select **Back** to return to the previous screen.

3-4. Using the rear seat entertainment system Using the DVD player (audio CD/CD text)

Using the control screen

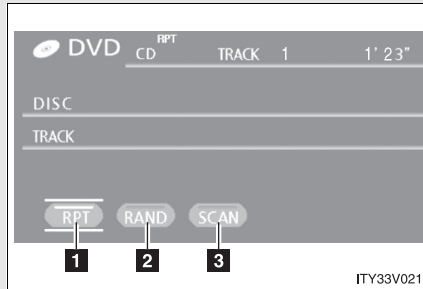

Press to display the control screen.

- 1** Repeat play
- 2** Random playback
- 3** Search playback

Operating from the front audio system

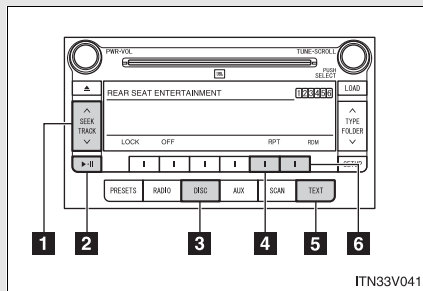

- 1** Press: Selecting a track
Press and hold: Fast-forwarding/rewinding a disc
- 2** Playing/pausing a disc
- 3** Selecting the DVD mode
- 4** Repeat play (→P. 298)
- 5** Displaying an elapsed time
- 6** Random playback (→P. 298)

3

Interior features

Canceling random, repeat and scan play

Select , or again.

3-4. Using the rear seat entertainment system Using the DVD player (MP3 discs)

n Using the control screen

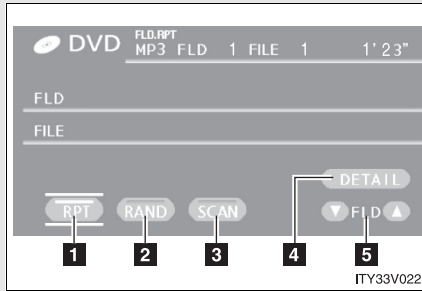

Press  to display the control screen.

- 1 Repeat play
- 2 Random playback
- 3 Search playback
- 4 Displaying file information
- 5 Selecting a folder

n Operating from the front audio system

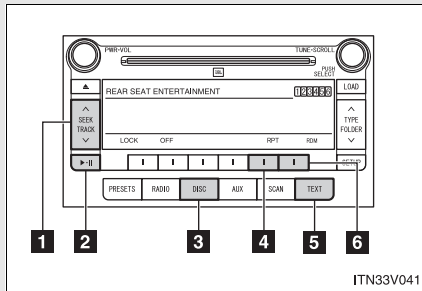



- 1 Press: Selecting a file
Press and hold: Fast-forwarding/rewinding a file
- 2 Playing/pausing a disc
- 3 Selecting the DVD mode
- 4 Repeat play (→P. 307)
- 5 Displaying an elapsed time
- 6 Random playback (→P. 306)

Repeat play

n Repeat a file

Select .

n Repeat all of files in a folder

Select , and press and hold  on the remote controller.

3-4. Using the rear seat entertainment system

Random playbackn **Playing files from a particular folder in random order**

Select **RAND** .

n **Playing all of the files on a disc in random order**

Select **RAND** , and press and hold  on the remote controller.

Search playbackn **Selecting the desired file by cueing the files in the folder**

Select **SCAN** .

The player will scan all the files in the folder. Each file will be played for 10 seconds.

n **Selecting the desired file by cueing the folders on the disc**

Select **SCAN** , and press and hold  the remote controller.

The player will scan all the folders on the disc. The first file in each folder will be played for 10 seconds.

3

Interior features

n **Canceling random, repeat and playback**

Select **RPT** , **RAND** or **SCAN** again.

3-4. Using the rear seat entertainment system

Using the video mode

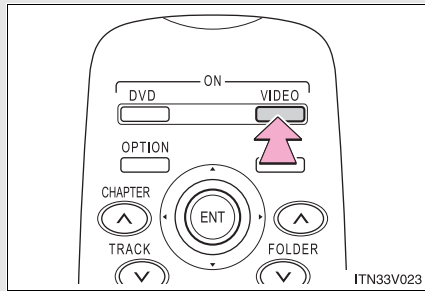

Press **VIDEO** to select the video mode.

Before switching to the video mode, connect the audio-video equipment to the A/V input port.

Using the adapter

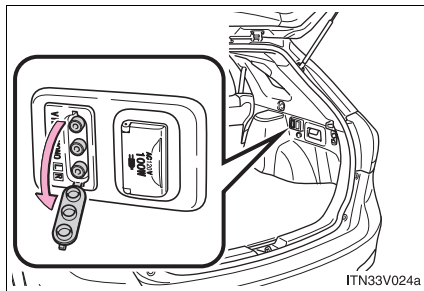

Open the cover.

The A/V input port is composed of 3 input adapters.

Yellow: Image input adapter

White: Left channel audio input adapter

Red: Right channel audio input adapter

3-4. Using the rear seat entertainment system

n **A/V input port**

The rear seat entertainment system plays videos and sound when audio-video equipment is connected to the A/V input port. For details, refer to the manufacturer's instructions.

n **Power outlet**

The power outlet is used to connect the audio-video equipment. (→P. 447)

NOTICE

n **When the A/V input port is not in use**

Keep the A/V input port cover closed.
Inserting anything other than an appropriate plug may cause electrical failure or a short circuit.

3

Interior features

3-4. Using the rear seat entertainment system

Changing the initial settings

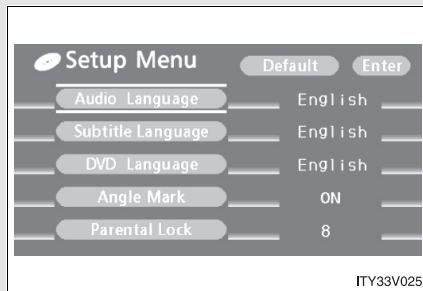

Press **SET UP** or select **Set Up** to display the initial setting screen.

The following initialization can be changed here.

- | Audio language
- | Subtitle language
- | DVD language
- | Angle mark
- | Parental lock

3-4. Using the rear seat entertainment system

Changing the audio language

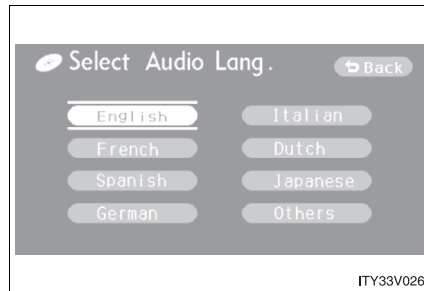

Select "Audio Language".

Select the language you want to hear, and press  to input it.

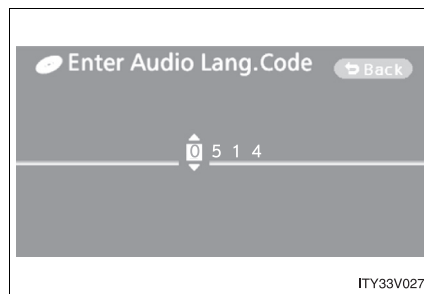

Select "Others" if you cannot find the language you want to hear. Enter the appropriate 4-digit language code. (→P. 387)

Select a number, and press  to input it.

If a code that is not in the list is entered, "Incorrect Code" will appear on the screen.

3

Interior features

Changing the subtitle language

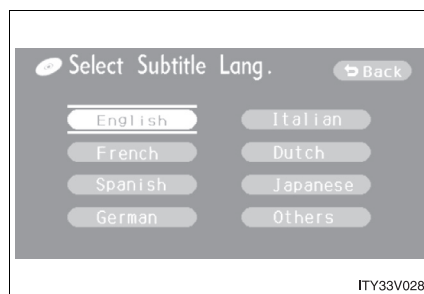

Select "Subtitle Language".

Select the language you want to read, and press  to input it.

3-4. Using the rear seat entertainment system

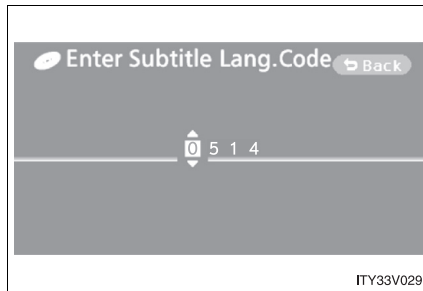

Select “Others” if you cannot find the language you want to read. Enter the appropriate 4-digit language code. (→P. 387)

Select a number, and press  to input it.

If a code that is not in the list is entered, “Incorrect Code” will appear on the screen.

Changing the DVD language



Select “DVD Language”.

Select the language you want to read, and press  to input it.

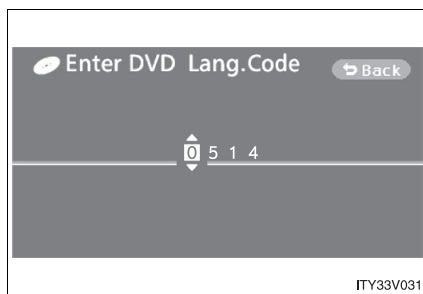

Select “Others” if you cannot find the language you want to read. Enter the appropriate 4-digit language code. (→P. 387)

Select a number, and press  to input it.

If a code that is not in the list is entered, “Incorrect Code” will appear on the screen.

3-4. Using the rear seat entertainment system

Turning on or off the angle mark

The angle mark can be turned on for discs that are multi-angle compatible.

Each time you press  when "Angle Mark" is selected, the angle mark turns on or off alternately.

Setting viewer restriction levels

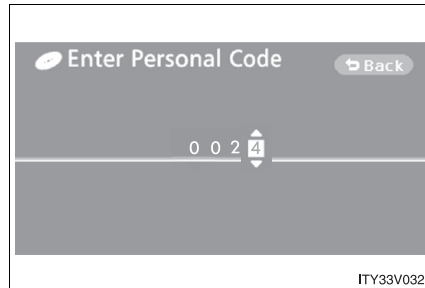

Setting a password allows the viewer restriction to be effective.

Select "Parental Lock".
Enter the password and press



The setting cannot be changed unless the password is entered.

When you forget the password, initialize the password.

(→P. 387)

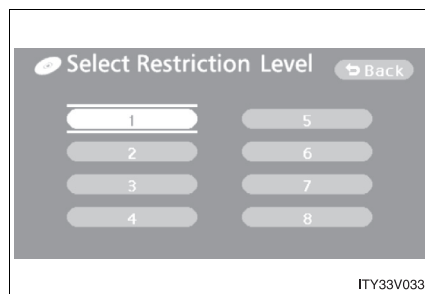

Select a restriction level (1-8), and press . The smaller the level number, the stricter the age limit.

3

Interior features

3-4. Using the rear seat entertainment system

Setting the display mode

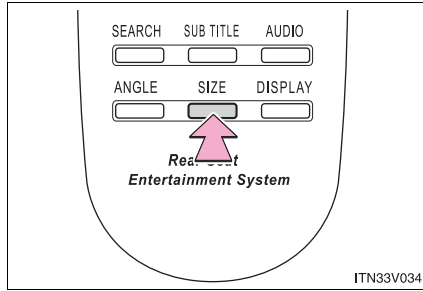

Pressing  changes the display modes sequentially as follows:

Normal → Wide 1 → Wide 2



3-4. Using the rear seat entertainment system

n **Returning to the previous screen**

Select **Back**, and press **ENT**.

n **To initialize the password**

Press **◀** on the remote controller 10 times when the screen to enter the personal code is displayed.

n **Language code list**

Code	Language	Code	Language	Code	Language
0514	English	0207	Bulgarian	0712	Galician
0618	French	0208	Bihari	0714	Guarani
0405	German	0209	Bislama	0721	Gujarati
0920	Italian	0214	Bengali	0801	Hausa
0519	Spanish	0215	Tibetan	0809	Hindi
2608	Chinese	0218	Breton	0818	Croatian
1412	Dutch	0301	Catalan	0821	Hungarian
1620	Portuguese	0315	Corsican	0825	Armenian
1922	Swedish	0319	Czech	0901	Interlingua
1821	Russian	0325	Welsh	0905	Interlingue
1115	Korean	0401	Danish	0911	Inupiak
0512	Greek	0426	Bhutani	0914	Indonesian
0101	Afar	0515	Esperanto	0919	Icelandic
0102	Abkhazian	0520	Estonian	0923	Hebrew
0106	Afrikaans	0521	Basque	1001	Japanese
0113	Amharic	0601	Persian	1009	Yiddish
0118	Arabic	0609	Finnish	1023	Javanese
0119	Assamese	0610	Fiji	1101	Georgian

3-4. Using the rear seat entertainment system

Code	Language	Code	Language	Code	Language
0125	Aymara	0615	Faroese	1111	Kazakh
0126	Azerbaijani	0625	Frisian	1112	Greenlandic
0201	Bashkir	0701	Irish	1113	Cambodian
0205	Byelorussian	0704	Scots-Gaelic	1114	Kannada
1119	Kashmiri	1415	Norwegian	1914	Shona
1121	Kurdish	1503	Occitan	1915	Somali
1125	Kirghiz	1513	(Afan) Oromo	1917	Albanian
1201	Latin	1518	Oriya	1918	Serbian
1214	Lingala	1601	Panjabi	1919	Siswati
1215	Laothian	1612	Polish	1920	Sesotho
1220	Lithuanian	1619	Pashto, Pushto	1921	Sundanese
1222	Latvian	1721	Quechua	1923	Swahili
1307	Malagasy	1813	Rhaeto-Romance	2001	Tamil
1309	Maori	1814	Kirundi	2005	Telugu
1311	Macedonian	1815	Romanian	2007	Tajik
1312	Malayalam	1823	Kinyarwanda	2008	Thai
1314	Mongolian	1901	Sanskrit	2009	Tigrinya
1315	Moldavian	1904	Sindhi	2011	Turkmen
1318	Marathi	1907	Sangho	2012	Tagalog
1319	Malay	1908	Serbo-Croatian	2014	Setswana

3-4. Using the rear seat entertainment system

Code	Language	Code	Language	Code	Language
1320	Maltese	1909	Sinhalese	2015	Tonga
1325	Burmese	1911	Slovak	2018	Turkish
1401	Nauru	1912	Slovenian	2019	Tsonga
1405	Nepali	1913	Samoan	2020	Tatar
2023	Twi	2209	Vietnamese	2515	Yoruba
2111	Ukrainian	2215	Volapük	2621	Zulu
2118	Urdu	2315	Wolof		
2126	Uzbek	2408	Xhosa		

n Adjusting the screen

► When displaying a video

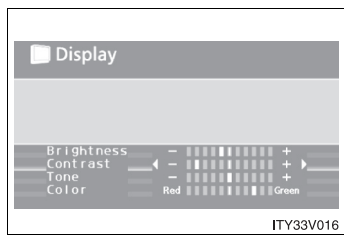

Press .

Select the brightness, contrast, tone or color, and make adjustments. Press or to input it.

► When not displaying a video

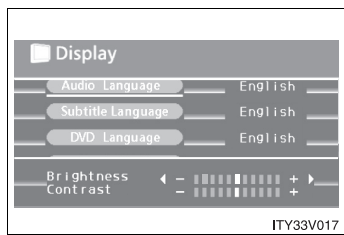

3

Interior features

3-4. Using the rear seat entertainment system

	"-" or "Red"	"+" or "Green"
Brightness	Darkens	Brightens
Contrast	Weakens the contrast	Strengthens the contrast
Tone *	Weakens the tone	Strengthens the tone
Color *	Strengthens the red color	Strengthens the green color

*: Color and tone can be adjusted while a DVD video, video CD or similar is being shown. Only contrast and brightness can be adjusted from the audio and other screens.

3-6. Using the interior lights

Interior lights list

Your Toyota is equipped with the illuminated entry system to assist in entering the vehicle. Due to the function of the system, the lights shown in the following illustration automatically turn on/off according to the presence of the electronic key (vehicles with smart key system), whether the doors are locked/unlocked, whether the doors are opened/closed, and the “ENGINE START STOP” switch mode (vehicles with smart key system) or engine switch position (vehicles without smart key system).

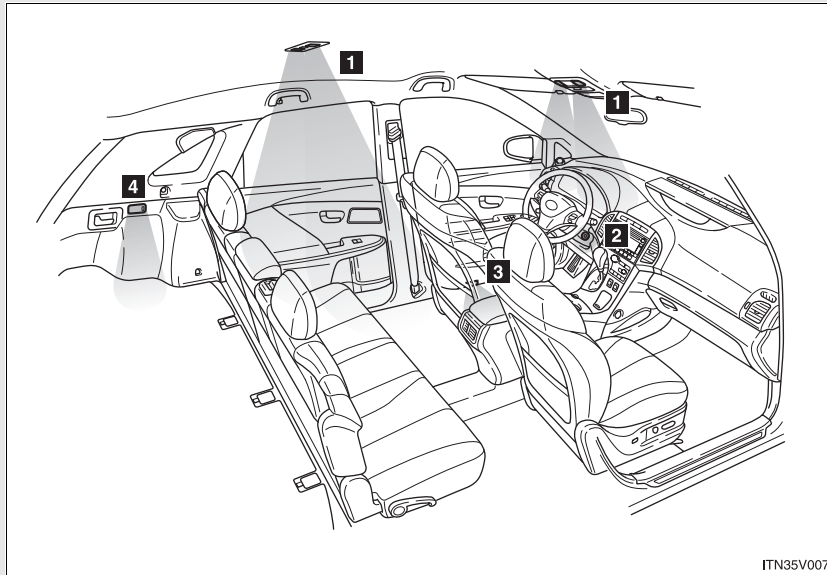

3-6. Using the interior lights

Personal/interior light main switch

- 1** Personal/interior lights
- 2** "ENGINE START STOP" switch light (vehicles with smart key system) or engine switch light (vehicles without smart key system)
- 3** Door courtesy lights
- 4** Luggage compartment light

Personal/interior light main switch

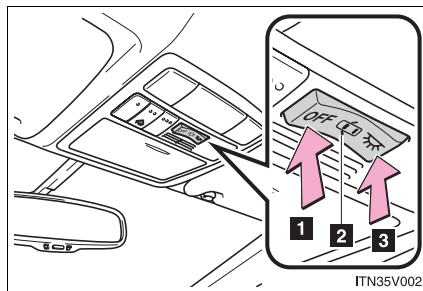

1 "OFF"

The personal/interior lights can be individually turned on or off.

2 Door position

The personal/interior lights come on when a door is opened. They turn off when the doors are closed.

3 On

The personal/interior lights cannot be individually turned off.

3

Interior features

3-6. Using the interior lights

Personal/interior lights and luggage compartment light

Personal/interior lights

► Front

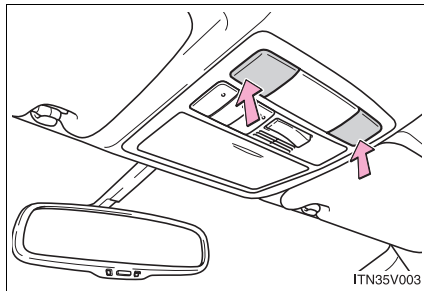

On/off

The illuminated entry system is activated even if the light is turned off when the personal/interior light main switch is in door position.

► Rear

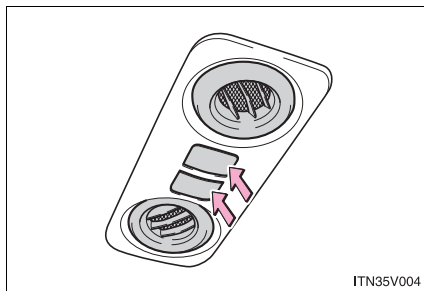

On/off

The illuminated entry system is activated even if the light is turned off when the personal/interior light main switch is in door position.

Luggage compartment light

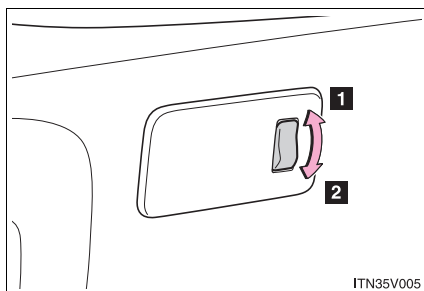

1 Door position

2 Off

3-6. Using the interior lights

n **Adjusting the rear personal/interior lights angle**

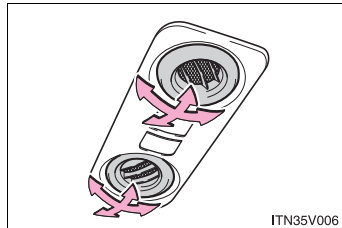

Push the edge of the light lens.

n **To prevent the battery from being discharged**

▶ Vehicles with smart key system

If the personal/interior lights and “ENGINE START STOP” switch light remain on when the door is not fully closed and the personal/interior light main switch is in door position, the lights will go off automatically after 20 minutes.

▶ Vehicles without smart key system

If the personal/interior lights and engine switch light remain on when the door is not fully closed and the personal/interior light main switch is in door position, the lights will go off automatically after 20 minutes.

n **Customization that can be configured at Toyota dealer or by the TFT type multi-information display**

Settings (e.g. The time elapsed before lights turn off) can be changed. (Customizable features →P. 640)

3

Interior features

3-7. Using the storage features

List of storage features

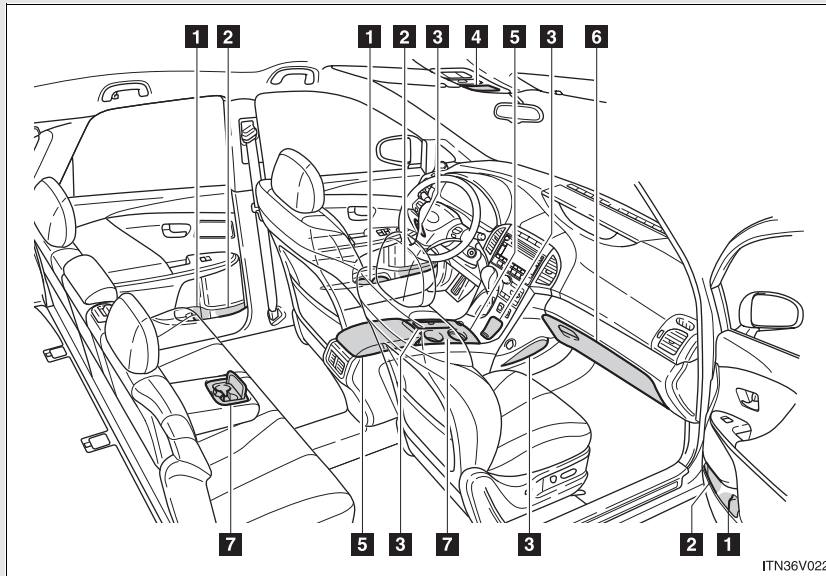

- 1** Bottle holders
- 2** Door pockets
- 3** Auxiliary boxes
- 4** Overhead console
- 5** Console boxes
- 6** Glove box
- 7** Cup holders

3-7. Using the storage features

Glove box

! CAUTION

n Items that should not be left in the storage spaces

Do not leave glasses, lighters or spray cans in the storage spaces, as this may cause the following when cabin temperature becomes high:

- I** Glasses may be deformed by heat or cracked if they come into contact with other stored items.
- I** Lighters or spray cans may explode. If they come into contact with other stored items, the lighter may catch fire or the spray can may release gas, causing a fire hazard.

Glove box

3

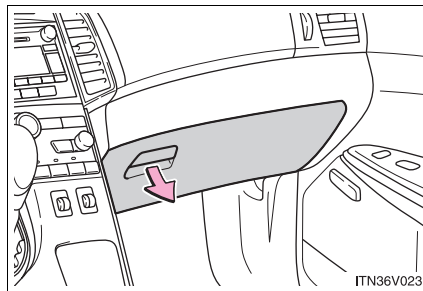

Pull up the lever.

Interior features

n Glove box light

The glove box light turns on when the tail lights are on.

! CAUTION

n While driving

Keep the glove box closed.

Injuries may result in the event of sudden braking, sudden swerving or an accident.

3-7. Using the storage features

Console boxes

Console boxes

► Front

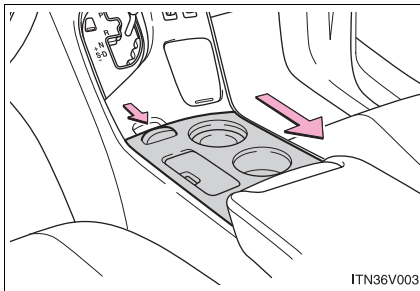

Press the tab and slide to open.

► Rear

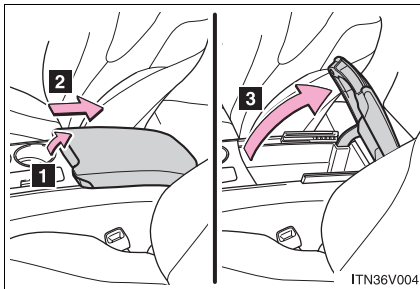

- 1** Pull up the lever to release the lock.
- 2** Slide the armrest fully rearward.
- 3** Lift the armrest to open.

3-7. Using the storage features

Console boxes

n When using the rear console box lid as an armrest

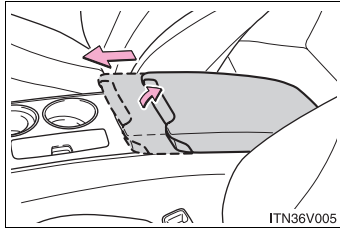

If necessary, the console box lid can slide forward. Pull the lid forward while pulling up the lever.

n Tray in the rear console box

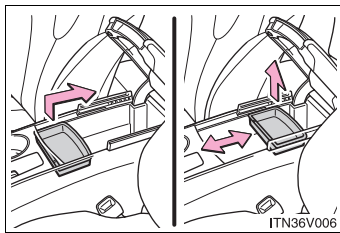

The tray slides forward/backward and can be removed.

3

Interior features

CAUTION

n While driving

Keep the console box closed.

Injuries may result in the event of sudden braking, sudden swerving or an accident.

3-7. Using the storage features

Overhead console

Overhead console

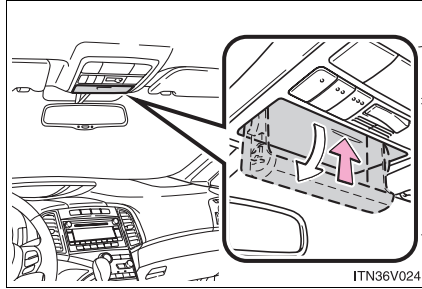

Push the lid.

The overhead console is useful for temporarily storing small items.

CAUTION

n While driving

Do not leave the overhead console open. Items may fall out and cause injury.

3-7. Using the storage features

Cup holders

Cup holders

► Front

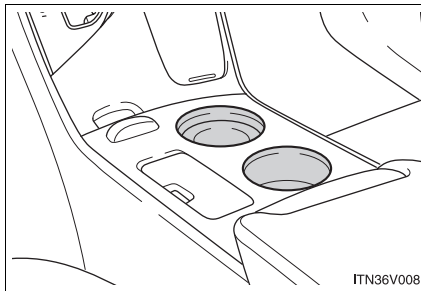

► Rear

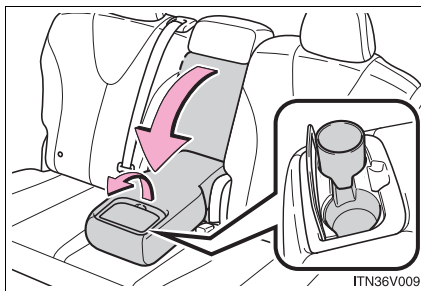

Pull down the armrest and open the lid.

3

Interior features

3-7. Using the storage features

Cup holders

n Adjusting size of the front cup holder

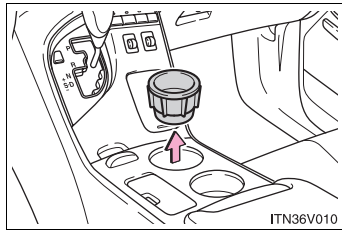

Remove the adapter.

! CAUTION

n Items unsuitable for the cup holder

Do not place anything other than cups or aluminum cans in the cup holders. Other items may be thrown out of the holders in the event of an accident or sudden braking and cause injury. If possible, cover hot drinks to prevent burns.

n When not in use

Keep the rear cup holders closed. Injuries may result in the event of sudden braking, sudden swerving or an accident.

3-7. Using the storage features

Bottle holders

Bottle holders

► For front seats

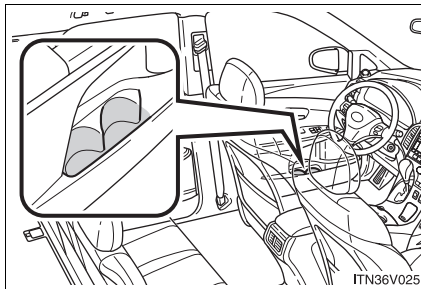

ITN36V025

► For rear seats

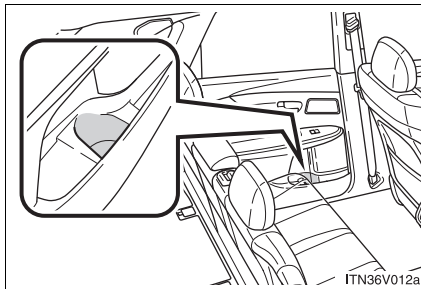

ITN36V012a

3

Interior features

NOTICE

n Items that should not be stowed in the bottle holders

Put the cap on before stowing a bottle. Do not place open bottles in the bottle holders, or glasses and paper cups containing liquid. The contents may spill and glasses may break.

3-7. Using the storage features

Auxiliary boxes

Auxiliary boxes

► Type A (driver's side instrument panel)

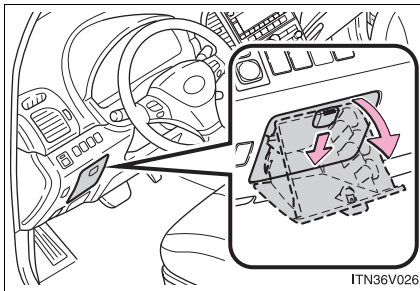

Push down the knob.

► Type B (front console)

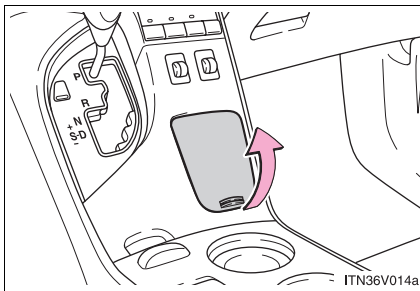

Lift the lid.

► Type C (front console)

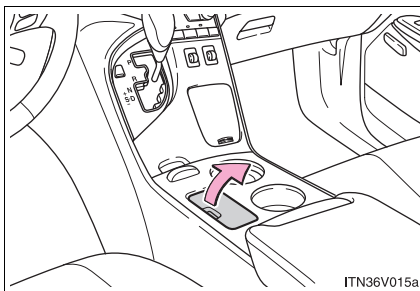

Lift the lid.

3-7. Using the storage features

Auxiliary boxes

► Type D (front passenger's side instrument panel)

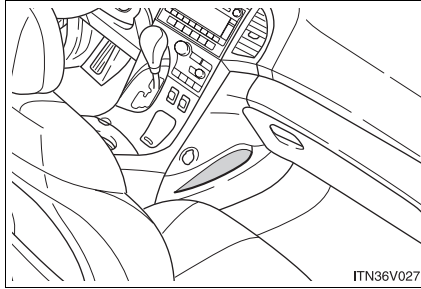

n Coin holder (type A)

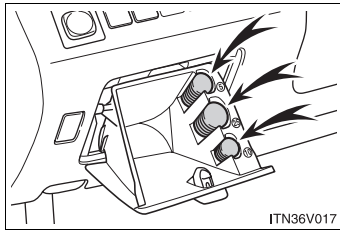

Nickels, quarters and dimes can be stored separately.

3

Interior features

3-7. Using the storage features

Auxiliary boxes

n Cable pass-through (type B and C)

► Type B

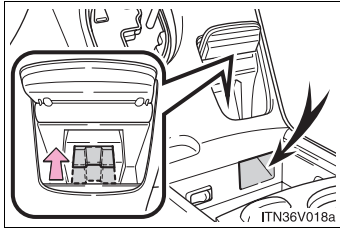

The auxiliary boxes of the front console are provided with a hole that allows cables to be passed from the power outlet and AUX port.

For type B, push in the push bar before routing the cables. Otherwise the connector end may get stuck.

► Type C

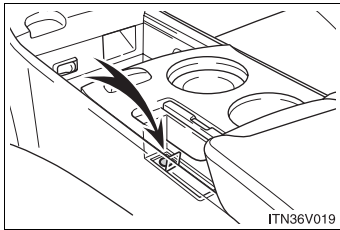

⚠ CAUTION

n While driving (type A, B and C)

Keep the auxiliary boxes closed.

Injuries may result in the event of sudden braking, sudden swerving or an accident.

3-8. Other interior features

Sun visors

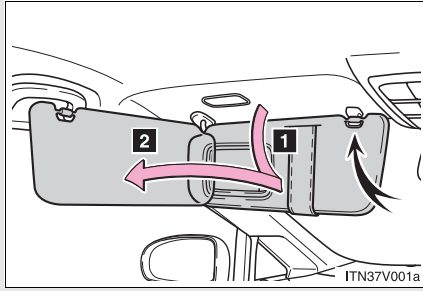

- 1** Forward position:
Flip down.
- 2** Side position:
Flip down, unhook, and swing to the side.

3

Interior features

3-8. Other interior features

Vanity mirror

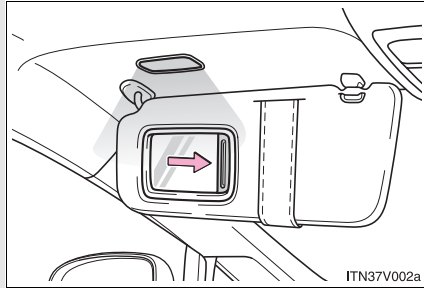

Slide the cover.

The light turns on when the cover is opened (if equipped).

3-8. Other interior features

Power outlets

The power outlets can be used for a following component.

- 12 V: Accessories that run on less than 10 A.
- 120 V AC*: Accessories that use less than 100 W.

► Console box (12 V)

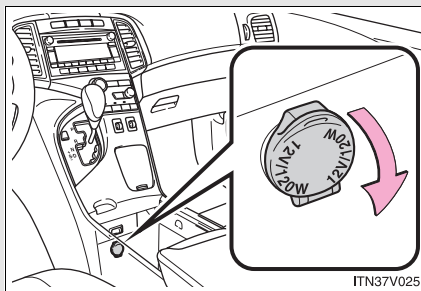

► Front passenger's side instrument panel (12 V)

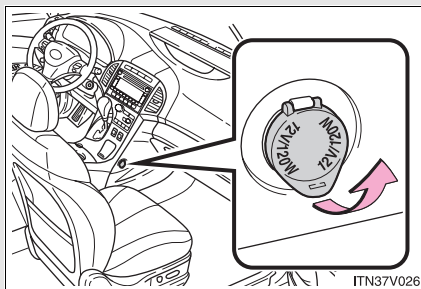

► Luggage compartment (12 V)

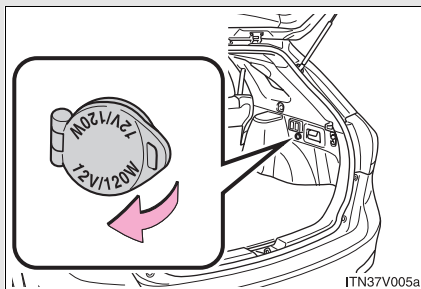

3-8. Other interior features

► Luggage compartment (120 V AC)*

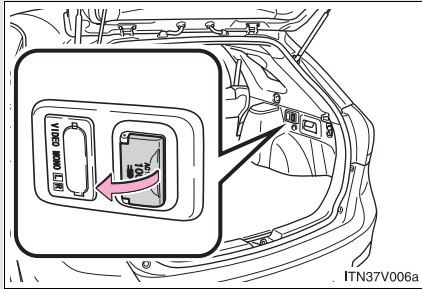

*: Vehicles with rear seat entertainment system

n The power outlets can be used when

► Vehicles with smart key system

12 V: The "ENGINE START STOP" switch is in ACCESSORY or IGNITION ON mode.

120 V: The "ENGINE START STOP" switch is in IGNITION ON mode.

► Vehicles without smart key system

12 V: The engine switch is in the "ACC" or "ON" position.

120 V: The engine switch is in the "ON" position.

n Radio noise (120 V AC)

The use of certain electrical appliances may cause radio noise interference.

3-8. Other interior features

NOTICE

n To avoid damaging the power outlets

Close the power outlet lid when not in use.
Foreign objects or liquids that enter the power outlet may cause a short circuit.

n To prevent the fuse from being blown

12 V: Do not use an accessory that uses more than 12 V/10 A.
120 V: Do not use a 120 V AC appliance that requires more than 100 W.
If a 120 V AC appliance that consumes more than 100 W is used, the protection circuit will cut the power supply.

n To prevent the battery from being discharged

Do not use the power outlet longer than necessary when the engine is not running.

n Appliances that may not operate properly (120 V AC)

The following 120 V AC appliances may not operate even if their power consumption is under 100 W.

- l** Appliances with high initial peak wattage
- l** Measuring devices that process precise data
- l** Other appliances that require an extremely stable power supply

3

Interior features

3-8. Other interior features

Seat heaters*

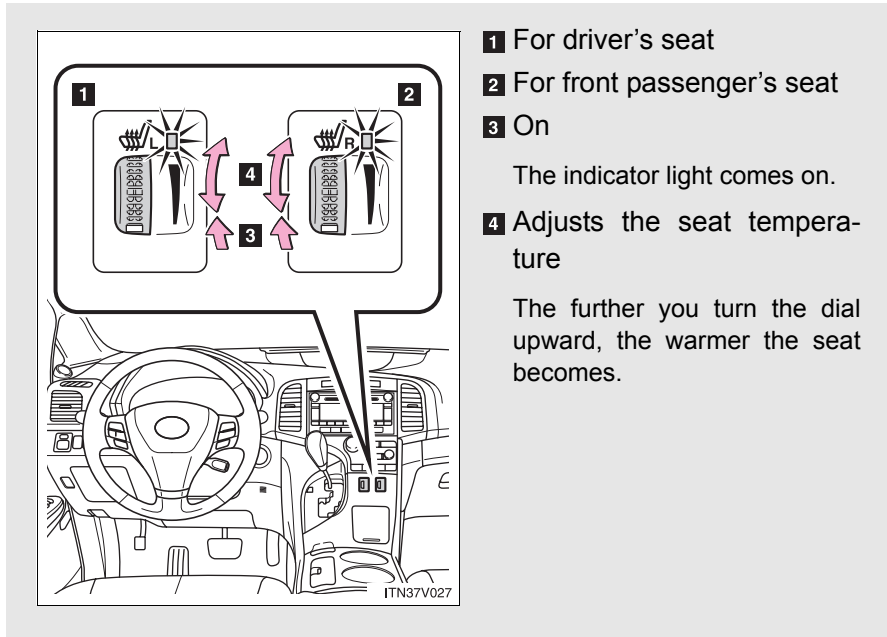

n The seat heaters can be used when

- ▶ Vehicles with smart key system
The "ENGINE START STOP" switch is in IGNITION ON mode.
- ▶ Vehicles without smart key system
The engine switch is in the "ON" position.

*: If equipped

3-8. Other interior features

 CAUTION

n Burns

I Use caution when seating the following persons in a seat with the seat heater on to avoid the possibility of burns:

- Babies, small children, the elderly, the sick and the disabled
- Persons with sensitive skin
- Persons who are fatigued
- Persons who have taken alcohol or drugs that induce sleep (sleeping drugs, cold remedies, etc.)

I Do not cover the seat with anything when using the seat heater. Using the seat heater with a blanket or cushion increases the temperature of the seat and may lead to overheating.

3

 NOTICE

n To prevent seat heater damage

Do not put unevenly weighted objects on the seat and do not stick sharp objects (needles, nails, etc.) into the seat.

n To prevent battery discharge

Turn the switches off when the engine is not running.

Interior features

3-8. Other interior features

Armrest

► Front

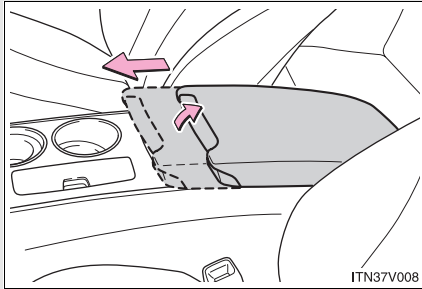

Lift the lever up and slide the armrest.

► Rear

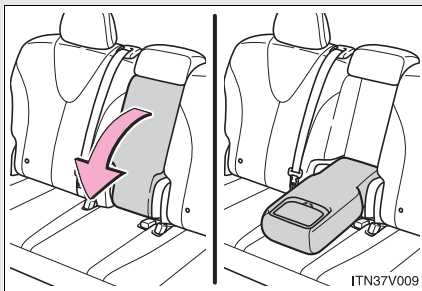

Pull the armrest down for use.

NOTICE

n To prevent damage to the armrest

Do not place too much strain on the armrest.

3-8. Other interior features

Floor mats

Use only floor mats designed specifically for vehicles of the same model and model year as your vehicle. Fix them securely in place onto the carpet.

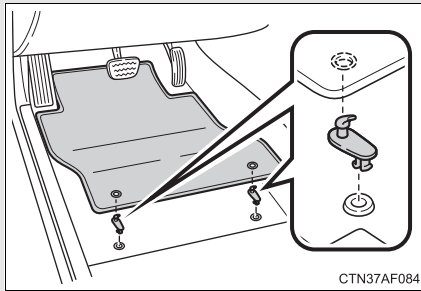

Fix the floor mat in place using the retaining hooks (clips) provided.

The shape of the retaining hooks (clips) and the fixing procedure of the floor mat for your vehicle may differ from those shown in the illustration. For details, refer to the floor mat retention clip installation instructions supplied with the clips.

3

Interior features

3-8. Other interior features

! CAUTION

Observe the following precautions.

Failure to do so may cause the driver's floor mat to slip, possibly interfering with the pedals while driving. An unexpectedly high speed may result or it may become difficult to stop the vehicle, leading to a serious accident.

n When installing the driver's floor mat

- ! Do not use floor mats designed for other models or different model year vehicles, even if they are Toyota Genuine floor mats.
- ! Only use floor mats designed for the driver's seat.
- ! Always install the floor mat securely using the retaining hooks (clips) provided.
- ! Do not use two or more floor mats on top of each other.
- ! Do not place the floor mat bottom-side up or upside-down.

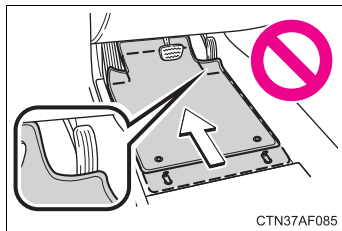
n Before driving

- ! Check that the floor mat is securely fixed in the right place with all the provided retaining hooks (clips). Be especially careful to perform this check after cleaning the floor.
- ! With the engine stopped and the shift lever in P, fully depress each pedal to the floor to make sure it does not interfere with the floor mat.

3-8. Other interior features

Luggage compartment features

n Cargo hooks

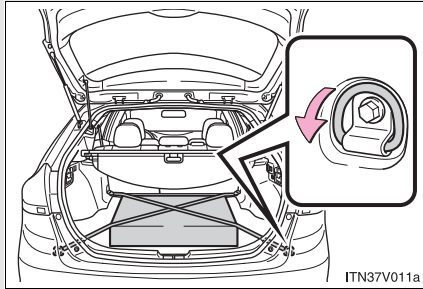

Cargo hooks are provided for securing loose items.

n Shopping bag hooks

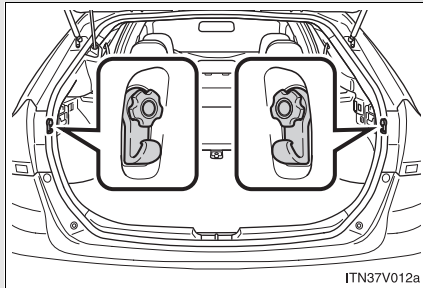

n Auxiliary box

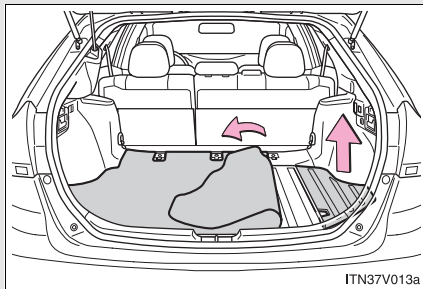

Lift the right side deck board.

3-8. Other interior features

n Luggage cover (if equipped)

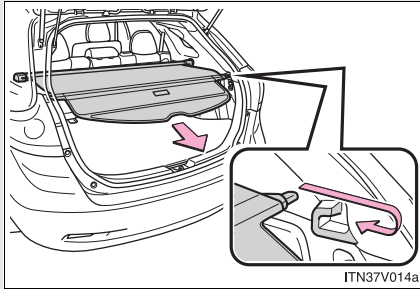

Pull out the luggage cover and hook it on the anchors.

Removing luggage cover (vehicles with luggage cover)

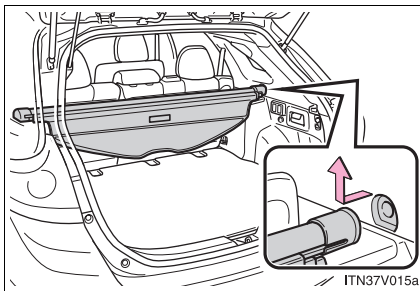

Retract the cover and release both ends, then lift it out.

After removing the luggage cover, place it somewhere other than the passenger compartment.

! CAUTION

n When the cargo hooks are not in use

To avoid injury, always return the cargo hooks to their positions when they are not in use.

n While driving

Do not place anything on the luggage cover. Such items may be thrown about and possibly injure people in the vehicle during sudden braking, sudden swerving or an accident.

3-8. Other interior features

Garage door opener*

The garage door opener can be programmed to operate garage doors, gates, entry doors, door locks, home lighting systems, security systems, and other devices.

The garage door opener (HomeLink® Universal Transceiver) is manufactured under license from HomeLink®.

Programming HomeLink® (for U.S.A. owners)

To ensure correct programming into the HomeLink®, install a new battery in the hand-held transmitter prior to programming. Failure to install a new battery into the hand-held transmitter will affect both the range and accuracy of the HomeLink® in your vehicle.

The battery side of the hand-held transmitter must be pointed away from the HomeLink® during the programming process.

The HomeLink® compatible transceiver in your vehicle has 3 buttons which can be programmed to operate 3 different devices. Refer to the programming method below appropriate for the device.

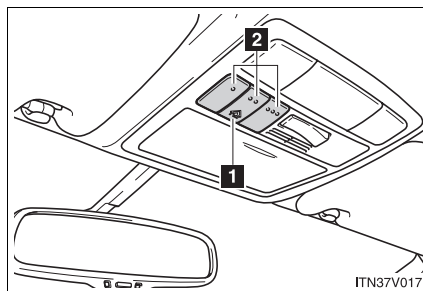

- 1 Indicator
- 2 Buttons

3

Interior features

*: If equipped

3-8. Other interior features

n Programming HomeLink®

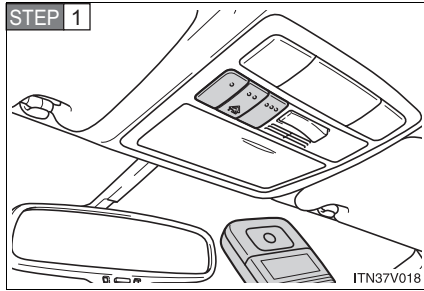

Point the remote control transmitter for the device 1 to 3 in. (25 to 75 mm) from the HomeLink® buttons.

Keep the HomeLink® indicator light in view while programming.

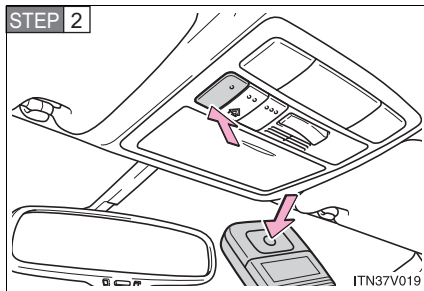

Press and hold one of the HomeLink® buttons and the transmitter button. When the HomeLink® indicator light changes from a slow to a rapid flash within 20 seconds, you can release both buttons.

3-8. Other interior features

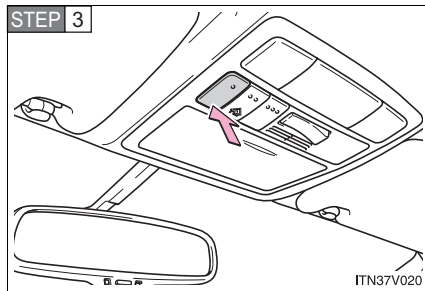

Test the HomeLink[®] operation by pressing the newly programmed button.

If a HomeLink[®] button has been programmed for a garage door, check to see if the garage door opens and closes. If the garage door does not operate, see if your remote control transmitter is of the rolling code type. Press and hold the programmed HomeLink[®] button. The remote control transmitter is of the rolling code type if the HomeLink[®] indicator light flashes rapidly for 2 seconds and then remains lit. If your transmitter is of the rolling code type, proceed to the heading "Programming a rolling code system".

STEP 4 Repeat the steps above to program another device for each of the remaining HomeLink[®] buttons.

3

Interior features

3-8. Other interior features

n Programming a rolling code system

If your device is rolling code equipped, follow the steps under the heading “Programming HomeLink[®]” before proceeding with the steps listed below.

STEP 1 Locate the learn button on the ceiling mounted garage door opener motor. The exact location and color of the button may vary by brand of garage door opener motor.

Refer to the operation manual supplied with the garage door opener motor for the location of the learn button.

STEP 2 Press the learn button.

Following this step, you have 30 seconds in which to initiate step 3 below.

STEP 3 Press and hold the vehicle’s programmed HomeLink[®] button for 2 seconds and release it. Repeat this step once again. The garage door may open.

If the garage door opens, the programming process is complete. If the door does not open, press and release the button a third time. This third press and release will complete the programming process by opening the garage door.

The ceiling mounted garage door opener motor should now recognize the HomeLink[®] signal and operate the garage door.

STEP 4 Repeat the steps above to program another rolling code system for any of the remaining HomeLink[®] buttons.

3-8. Other interior features

■ Programming an entry gate (for U.S.A. owners)/Programming all devices in the Canadian market

STEP 1 Place your transmitter 1 to 3 in. (25 to 75 mm) away from the surface of the HomeLink®.

Keep the HomeLink® indicator light in view while programming.

STEP 2 Press and hold the selected HomeLink® button.

STEP 3 Repeatedly press and release (cycle) the device's remote control button for two seconds each until step 4 is completed.

STEP 4 When the indicator light on the HomeLink® compatible transceiver starts to flash rapidly, release the buttons.

STEP 5 Test the operation of the HomeLink® by pressing the newly programmed button. Check to see if the gate/device operates correctly.

STEP 6 Repeat the steps above to program another device for each of the remaining HomeLink® buttons.

■ Programming other devices

To program other devices such as home security systems, home door locks or lighting, contact your authorized Toyota dealer for assistance.

■ Reprogramming a button

The individual HomeLink® buttons cannot be erased but can be reprogrammed. To reprogram a button, follow the "Programming" instructions.

3

Interior features

3-8. Other interior features

Operating HomeLink®

Press the appropriate HomeLink® button. The HomeLink® indicator light should come on.

The HomeLink® compatible transceiver in your vehicle continues to send a signal for up to 20 seconds as long as the button is pressed.

Erasing the entire HomeLink® memory (all three programs)

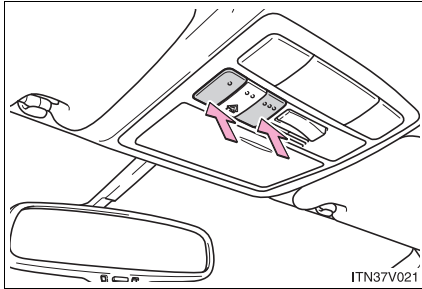

Press and hold the 2 outside buttons for 10 seconds (or 20 seconds depending on the model) until the indicator light flashes.

If you sell your vehicle, be sure to erase the programs stored in the HomeLink® memory.

3-8. Other interior features

n Before programming

- l Install a new battery in the remote control transmitter.
- l The battery side of the remote control transmitter must be pointed away from the HomeLink® button.

n Certification for the garage door opener

FCC ID: CB2300NHL3

FCC ID: CB2281AHL4

NOTE:

This device complies with Part 15 of the FCC Rules.

Operation is subject to the following two conditions: (1) this device may not cause harmful interference, and (2) this device must accept any interference received, including interference that may cause undesired operation.

FCC WARNING:

Changes or modifications not expressly approved by the party responsible for compliance could void the user's authority to operate the equipment.

n For additional programming assistance with your HomeLink® Universal Transceiver

Visit on the web at www.homelink.com or call 1-800-355-3515.

⚠ CAUTION

n When programming a garage door or other remote control devices

The garage door or other devices may operate, so ensure people and objects are out of danger to prevent potential harm.

n Conforming to federal safety standards

Do not use the HomeLink® compatible transceiver with any garage door opener or device that lacks safety stop and reverse features as required by federal safety standards.

This includes any garage door that cannot detect an interfering object. A door or device without these features increases the risk of death or serious injury.

3-8. Other interior features

Compass*

The compass on the inside rear view mirror indicates the direction in which the vehicle is heading.

n Operation

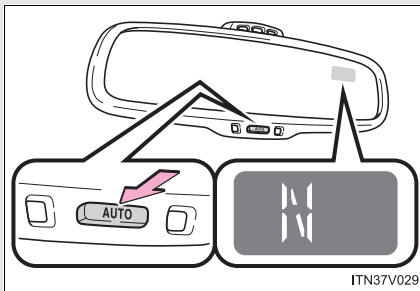

To turn the compass on or off, push and hold "AUTO" for longer than 3 seconds.

n Displays and directions

Display	Direction
N	North
NE	Northeast
E	East
SE	Southeast
S	South
SW	Southwest
W	West
NW	Northwest

*: If equipped

Calibrating the compass

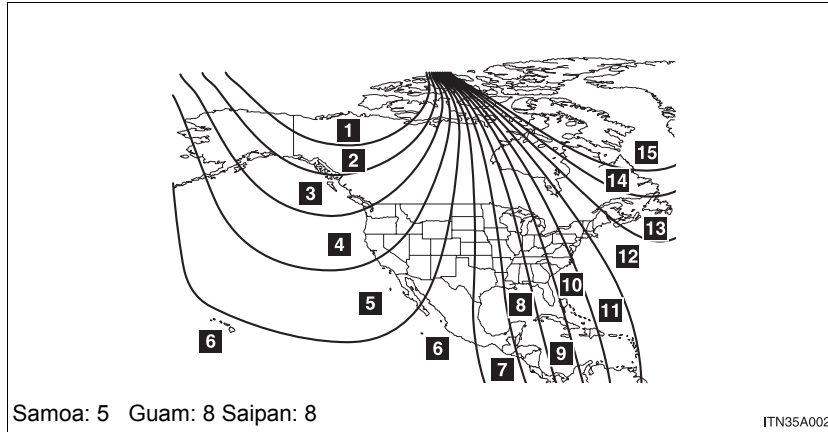

The direction display deviates from the true direction determined by the earth's magnetic field. The amount of deviation varies according to the geographic position of the vehicle.

If you cross over a map boundary shown in illustration, the compass will deviate.

To obtain higher precision or perfect calibration, refer to the following.

3

Interior features

3-8. Other interior features

n Deviation calibration

STEP 1 Stop the vehicle where it is safe to drive in a circle.

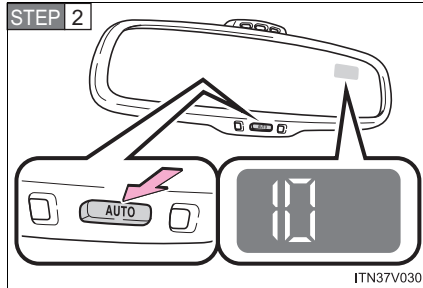

Push and hold "AUTO" until a number (1 to 15) appears on the compass display.

STEP 3 Press "AUTO", and referring to the map above, select the number of the zone where you are.

STEP 4 Wait a few seconds until the compass direction is displayed.
The calibration is complete.

n Circling calibration

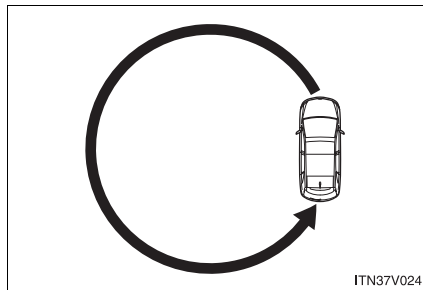

If "C" appears on the display, drive the vehicle at 5 mph (8 km/h) or less in a circle until a direction is displayed.

If there is not enough space to drive in a circle, drive around the block until the direction is displayed.

3-8. Other interior features

n Conditions unfavorable to correct operation

The compass may not show the correct direction in the following conditions:

- l The vehicle is stopped immediately after turning.
- l The vehicle is on an inclined surface.
- l The vehicle is in a place where the earth's magnetic field is subject to interference by artificial magnetic fields (underground car park/parking lot, under a steel tower, between buildings, roof car park/parking lot, near an intersection, near a large vehicle, etc.).
- l The vehicle has become magnetized.
(There is a magnet or metal object near the inside rear view mirror.)
- l The battery has been disconnected.

! CAUTION

n While driving

Do not adjust the display.
Be sure to adjust the display only when the vehicle is stopped.

n When doing the circling calibration

Be sure to secure a wide space, and watch out for people and vehicles in the neighborhood. Do not violate any local traffic rules while performing circling calibration.

3

Interior features

3-8. Other interior features

NOTICE

n To avoid the compass malfunctions

Do not place magnets or any metal objects near the inside rear view mirror. Doing this may cause a malfunction of the compass sensor.

n To ensure normal operation of the compass

- I** Do not perform circling calibration of the compass in a place where the earth's magnetic field is subject to interference by artificial magnetic fields.
- I** During calibration, do not operate electric systems (moon roof, power windows, etc.) as they may interfere with the calibration.

Maintenance and care

4

4-1. Maintenance and care

- Cleaning and protecting the vehicle exterior 470
- Cleaning and protecting the vehicle interior 473

4-2. Maintenance

- Maintenance requirements 476
- General maintenance 478
- Emission inspection and maintenance (I/M) programs 481

4-3. Do-it-yourself maintenance

- Do-it-yourself service precautions 482
- Hood 486
- Positioning a floor jack 488
- Engine compartment 490
- Tires 506
- Tire inflation pressure 513
- Wheels 517
- Air conditioning filter 520
- Key battery 523
- Checking and replacing fuses 527
- Light bulbs 537

4-1. Maintenance and care

Cleaning and protecting the vehicle exterior

Perform the following to protect the vehicle and maintain it in prime condition.

- 1 Working from top to bottom, liberally apply water to the vehicle body, wheel wells and underside of the vehicle to remove any dirt and dust.

Wash the vehicle body using a sponge or soft cloth, such as a cham-
ois.

- 1 For hard-to-remove marks, use car wash soap and rinse thor-
oughly with water.
- 1 Wipe away any water.
- 1 Wax the vehicle when the waterproof coating deteriorates.

If water does not bead on a clean surface, apply wax when the vehicle
body is cool.

n Automatic car washes

- 1 Before washing the vehicle, do the following.
 - Fold the mirrors back.
 - Turn the power back door system off.
- 1 Brushes used in automatic car washes may scratch the vehicle surface
and harm your vehicle's paint.

4-1. Maintenance and care

n High pressure car washes

- l Do not allow the nozzles of the car wash to come within close proximity of the windows.
- l Before car wash, check that the fuel filler door is closed.

n Aluminum wheels

- l Remove any dirt immediately by using a neutral detergent. Do not use hard brushes or abrasive cleaners. Do not use strong or harsh chemical cleaners. Use the same mild detergent and wax as used on the paint.
- l Do not use detergent on the wheels when they are hot, for example after driving for long distance in the hot weather.
- l Wash detergent from the wheels immediately after use.

n Bumpers and side moldings

- Do not scrub with abrasive cleaners.

! CAUTION

n Caution about the exhaust pipe

Exhaust gasses cause the exhaust pipe to become quite hot. When washing the vehicle, be careful not to touch the pipe until it has cooled sufficiently, as touching a hot exhaust pipe can cause burns.

4

Maintenance and care

4-1. Maintenance and care

NOTICE

n To prevent paint deterioration and corrosion on the body and components (aluminum wheels etc.)

l Wash the vehicle immediately in the following cases:

- After driving near the sea coast
- After driving on salted roads
- If you see coal tar or tree sap on the paint surface
- If you see dead insects, insect droppings or bird droppings on the paint
- After driving in an area contaminated with soot, oily smoke, mine dust, iron powder or chemical substances
- If the vehicle becomes heavily soiled in dust or mud
- If liquids such as benzine and gasoline are spilled on the paint surface

l If the paint is chipped or scratched, have it repaired immediately.

l To prevent the wheels from corroding, remove any dirt and store in a place with low humidity when storing the wheels.

n If the windshield washer nozzle become blocked

Contact your Toyota dealer. Do not try to clear it with a pin or other object. This may damage the nozzle.

n Cleaning the exterior lights

l Wash carefully. Do not use organic substances or scrub with a hard brush. This may damage the surfaces of the lights.

l Do not apply wax on the surface of the lights. Wax may cause damage to the lenses.

n To prevent damage to the windshield wiper arms

When lifting the wiper arms away from the windshield, pull the driver side wiper arm upward first, and repeat for the passenger side. When returning the wipers to their original position, do so from the passenger side first.

4-1. Maintenance and care

Cleaning and protecting the vehicle interior

The following procedures will help protect your vehicle's interior and keep it in top condition:

n **Protecting the vehicle interior**

Remove dirt and dust using a vacuum cleaner. Wipe dirty surfaces with a cloth dampened with lukewarm water.

n **Cleaning the leather areas**

1 Remove dirt and dust using a vacuum cleaner.

1 Wipe any excess dirt and dust with a soft cloth dampened with diluted detergent.

Use a diluted water solution of approximately 5% neutral wool detergent.

1 Wring out any excess water from the cloth and thoroughly wipe off all remaining traces of detergent.

1 Wipe the surface with a dry, soft cloth to remove any remaining moisture. Allow the leather to dry in shaded and ventilated area.

n **Synthetic leather areas**

1 Remove loose dirt using a vacuum cleaner.

1 Apply a mild soap solution to the synthetic leather using a sponge or soft cloth.

1 Allow the solution to soak in for a few minutes. Remove the dirt and wipe off the solution with a clean, damp cloth.

4-1. Maintenance and care

n **Caring for leather areas**

Toyota recommends cleaning the interior of the vehicle at least twice a year to maintain the quality of the vehicle's interior.

n **Shampooing the carpets**

There are several commercial foaming-type cleaners available. Use a sponge or brush to apply the foam. Rub in overlapping circles. Do not apply water. Excellent results are obtained by keeping the carpet as dry as possible.

n **Seat belts**

Clean with mild soap and lukewarm water using a cloth or sponge. Also check the belts periodically for excessive wear, fraying or cuts.

CAUTION

n **Water in the vehicle**

- I Do not splash or spill liquid in the vehicle.
Doing so may cause electrical components etc. to malfunction or catch fire.
- I Do not get any of the SRS components or wiring in the vehicle interior wet.
(→P. 109)
Electrical malfunction may cause the airbags to deploy or not function properly, resulting in death or serious injury.

n **Cleaning the interior (especially instrument panel)**

Do not use polish wax or polish cleaner. The instrument panel may reflect off the windshield, obstructing the driver's view and leading to an accident, resulting in death or serious injury.

 NOTICE

n Cleaning detergents

- I** Do not use the following types of detergent, as they may discolor the vehicle interior or cause streaks or damage to painted surfaces.
 - Non-seat portions: Organic substances such as benzene or gasoline, alkaline or acidic solutions, dye, or bleach.
 - Seats: Acidic solutions, such as thinner, benzene, or alcohol.
- I** Do not use polish wax or polish cleaner. The instrument panel's or other interior part's painted surface may be damaged.

n Preventing damage to leather surfaces

Observe the following precautions to avoid damage to and deterioration of leather surfaces.

- I** Remove any dust or dirt on leather surfaces immediately.
- I** Do not expose the vehicle to direct sunlight for extended periods of time. Park the vehicle in the shade, especially during summer.
- I** Do not place items made of vinyl, plastic, or that contain wax on the upholstery, as they may stick to the leather surface if the vehicle interior heats up significantly.

n Water on the floor

Do not wash the vehicle floor with water.

Vehicle systems such as the audio system may be damaged if water comes into contact with electrical components under the floor of the vehicle, and may also cause the body to rust.

n Cleaning the inside of the rear window

- I** Be careful not to scratch or damage the heater wires or antenna.
- I** Do not use glass cleaner to clean the rear window, as this may cause damage to the rear window defogger heater wires or antenna. Use a cloth dampened with lukewarm water to gently wipe the window clean. Wipe the window in strokes running parallel to the heater wires or antenna.

4-2. Maintenance

Maintenance requirements

To ensure safe and economical driving, day-to-day care and regular maintenance is essential. It is the owner's responsibility to perform regular checks. Toyota recommends the following maintenance.

n General maintenance

Should be performed on a daily basis. This can be done by yourself or by a Toyota dealer.

n Scheduled maintenance

Should be performed at specified intervals according to the maintenance schedule.

For details about maintenance items and schedules, refer to the "Scheduled Maintenance Guide", "Owner's Manual Supplement".

n Do-it-yourself maintenance

You can perform some maintenance procedures yourself. Please be aware that do-it-yourself maintenance may affect warranty coverage.

The use of Toyota Repair Manuals is recommended.

For details about warranty coverage, see the separate "Owner's Warranty Information Booklet", "Owner's Manual Supplement".

n Repair and replacement

It is recommended that genuine Toyota parts be used for repair to ensure performance of each system. If non-Toyota parts are used in replacement or if a repair shop other than a Toyota dealer performs repairs, confirm the warranty coverage.

n Allow inspection and repairs to be performed by a Toyota dealer

- l Toyota technicians are well-trained specialists and are kept up to date with the latest service information. They are well informed about the operations of all systems on your vehicle.
- l Keep a copy of the repair order. It proves that the maintenance that has been performed is under warranty coverage. If any problem should arise while your vehicle is under warranty, your Toyota dealer will promptly take care of it.

! CAUTION

n Warning in handling of battery, oils, fuels, and fluids

- l Engine exhaust, some of its constituents, and a wide variety of automobile components contain or emit chemicals known to the State of California to cause cancer and birth defects and other reproductive harm. Work in a well ventilated area.
- l Oils, fuels and fluids contained in vehicles as well as waste produced by component wear contain or emit chemicals known to the State of California to cause cancer and birth defects or other reproductive harm. Avoid exposure and wash any affected area immediately.
- l Battery posts, terminals and related accessories contain lead and lead compounds which are known to cause brain damage. Wash your hands after handling. (→P. 502)

4-2. Maintenance

General maintenance

Listed below are the general maintenance items that should be performed at the intervals specified in the “Scheduled Maintenance Guide”, “Owner’s Manual Supplement”. It is recommended that any problem you notice should be brought to the attention of your Toyota dealer or qualified service shop for advice.

Engine compartment

Items	Check points
Battery	• Maintenance-free (→P. 502)
Brake fluid	• At the correct level? (→P. 500)
Engine coolant	• At the correct level? (→P. 497)
Engine oil	• At the correct level? (→P. 492)
Exhaust system	• No fumes or strange sounds?
Radiator/condenser/hoses	• Not blocked with foreign matter? (→P. 499)
Washer fluid	• At the correct level? (→P. 505)

Vehicle interior

Items	Check points
Accelerator pedal	<ul style="list-style-type: none"> • Moves smoothly (without uneven pedal effort or catching)?
Automatic transmission "Park" mechanism	<ul style="list-style-type: none"> • Can the vehicle be held securely on an incline with the shift lever in "P"?
Brake pedal	<ul style="list-style-type: none"> • Moves smoothly? • Does it have appropriate clearance and correct amount of free play?
Brakes	<ul style="list-style-type: none"> • Pulls to one side when applied? • Loss of brake effectiveness? • Spongy feeling brake pedal? • Pedal almost touches floor?
Head restraints	<ul style="list-style-type: none"> • Move smoothly and lock securely?
Indicators/buzzers	<ul style="list-style-type: none"> • Function properly?
Lights	<ul style="list-style-type: none"> • Do all the lights come on? • Headlights aimed correctly?
Parking brake	<ul style="list-style-type: none"> • Moves smoothly? • Can hold the vehicle securely on an incline?
Seat belts	<ul style="list-style-type: none"> • Does the seat belt system operate smoothly? • Are the belts undamaged?
Seats	<ul style="list-style-type: none"> • Do the seat controls operate properly?
Steering wheel	<ul style="list-style-type: none"> • Moves smoothly? • Has correct free play? • No strange noises?

4-2. Maintenance

Vehicle exterior

Items	Check points
Doors	<ul style="list-style-type: none">• Operate smoothly?
Engine hood	<ul style="list-style-type: none">• The lock system works properly?
Fluid leaks	<ul style="list-style-type: none">• Is there any leakage after parking?
Tire	<ul style="list-style-type: none">• Inflation pressure is correct?• Tire surfaces not worn or damaged?• Tires rotated according to the maintenance schedule?• Wheel nuts are not loose?

CAUTION

n If the engine is running

Turn off the engine and ensure that there is adequate ventilation before performing maintenance checks.

4-2. Maintenance

Emission inspection and maintenance (I/M) programs

Some states have vehicle emission inspection programs which include OBD (On Board Diagnostics) checks. The OBD system monitors the operation of the emission control system.

n If the malfunction indicator lamp comes on

The OBD system determines that a problem exists somewhere in the emission control system. Your vehicle may not pass the I/M test and may need to be repaired. Contact your Toyota dealer to service the vehicle.

n Your vehicle may not pass the I/M test:

- l When the battery is disconnected or discharged

Readiness codes that are set during ordinary driving are erased.

Also, depending on your driving habits, the readiness codes may not be completely set.

- l When the fuel tank cap is loose

The malfunction indicator lamp comes on as a temporary malfunction and your vehicle may not pass the I/M test.

n When the malfunction indicator lamp goes off after several driving trips

The error code in the OBD system will not be cleared unless the vehicle is driven 40 or more times.

n If your vehicle does not pass the I/M test

Contact your Toyota dealer to prepare the vehicle for re-testing.

4-3. Do-it-yourself maintenance

Do-it-yourself service precautions

If you perform maintenance yourself, be sure to follow the correct procedure given in these sections.

Items	Parts and tools
Battery condition (→P. 502)	<ul style="list-style-type: none"> • Warm water • Baking soda • Grease • Conventional wrench (for terminal clamp bolts)
Brake fluid level (→P. 500)	<ul style="list-style-type: none"> • FMVSS No.116 DOT 3 or SAE J1703 brake fluid • Rag or paper towel • Funnel (used only for adding brake fluid)
Engine coolant level (→P. 497)	<ul style="list-style-type: none"> • “Toyota Super Long Life Coolant” or similar high quality ethylene glycol based non-silicate, non-amine, non-nitrite and non-borate coolant with long-life hybrid organic acid technology. For the U.S.A.: “Toyota Super Long Life Coolant” is pre-mixed with 50% coolant and 50% deionized water. For Canada: “Toyota Super Long Life Coolant” is pre-mixed with 55% coolant and 45% deionized water. • Funnel (used only for adding coolant)

4-3. Do-it-yourself maintenance

Items	Parts and tools
Engine oil level (→P. 492)	<ul style="list-style-type: none"> • “Toyota Genuine Motor Oil” or equivalent • Rag or paper towel • Funnel (used only for adding engine oil)
Fuses (→P. 527)	<ul style="list-style-type: none"> • Fuse with same amperage rating as original
Radiator and condenser (→P. 499)	—
Tire inflation pressure (→P. 513)	<ul style="list-style-type: none"> • Tire pressure gauge • Compressed air source
Washer fluid (→P. 505)	<ul style="list-style-type: none"> • Water • Washer fluid containing antifreeze (for winter use) • Funnel (used only for adding washer fluid)

4-3. Do-it-yourself maintenance

CAUTION

The engine compartment contains many mechanisms and fluids that may move suddenly, become hot, or become electrically energized. To avoid death or serious injury observe the following precautions.

n When working on the engine compartment

- I** Keep hands, clothing, and tools away from the moving fan and engine drive belt.
- I** Be careful not to touch the engine, inverter, radiator, exhaust manifold, etc. right after driving as they may be hot. Oil and other fluids may also be hot.
- I** Do not leave anything that may burn easily, such as paper or rags, in the engine compartment.
- I** Do not smoke, cause sparks or expose an open flame to fuel or the battery. Fuel and battery fumes are flammable.
- I** Be extremely cautious when working on the battery. It contains poisonous and corrosive sulfuric acid.

⚠ CAUTION**n When working near the electric cooling fan or radiator grille****▶ Vehicles with smart key system**

Be sure the “ENGINE START STOP” switch is off. With the “ENGINE START STOP” switch in IGNITION ON mode, the electric cooling fan may automatically start to run if the air conditioning is on and/or if the coolant temperature is high. (→P. 499)

▶ Vehicles without smart key system

Be sure the engine switch is in the “LOCK” position. With the engine switch in the “ON” position, the electric cooling fan may automatically start to run if the air conditioning is on and/or if the coolant temperature is high. (→P. 499)

n When working on or under the vehicle

Do not get under the vehicle with just the jack supporting it. Always use automotive jack stands or other solid supports.

n Safety glasses

Wear safety glasses to prevent flying or falling material, fluid spray, etc. from getting in your eyes.

⚠ NOTICE**n If you remove the air cleaner filter**

Driving with the air cleaner filter removed may cause excessive engine wear due to dirt in the air. Also a backfire could cause a fire in the engine compartment.

4-3. Do-it-yourself maintenance

Hood

Release the lock from the inside of the vehicle to open the hood.

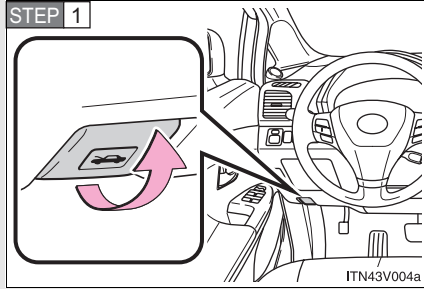

Pull the hood release lever.
The hood will pop up slightly.

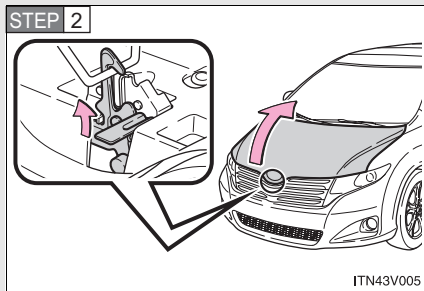

Lift the hood catch and lift the hood.

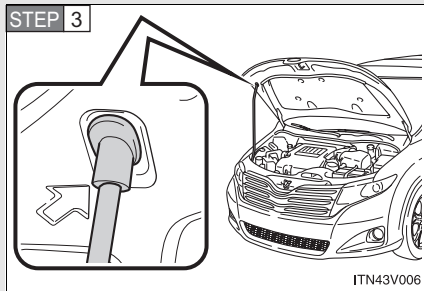

Hold the hood open by inserting the supporting rod into the slot.

4-3. Do-it-yourself maintenance

CAUTION

n Pre-driving check

Check that the hood is fully closed and locked.
If the hood is not locked properly it may open while the vehicle is in motion and cause an accident, which may result in death or serious injury.

n After installing the support rod into the slot

Make sure the rod supports the hood securely from falling down on to your head or body.

NOTICE

n When closing the hood

Be sure to return the support rod to its clip before closing the hood. Closing the hood with the support rod up could cause the hood to bend.

4-3. Do-it-yourself maintenance

Positioning a floor jack

When raising your vehicle with a floor jack, position the jack correctly. Improper placement may damage your vehicle or cause injury.

► Front

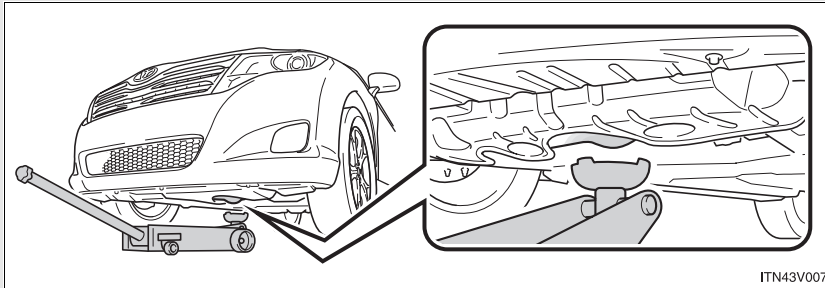

► Rear (2WD models)

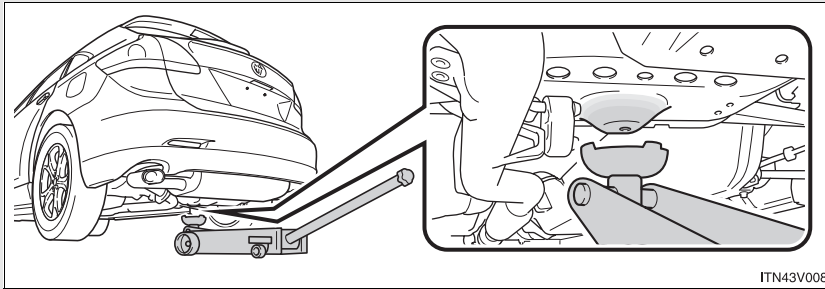

► Rear (AWD models)

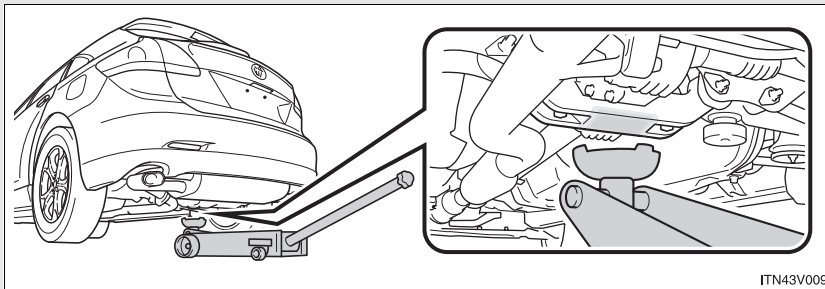

⚠ CAUTION**n When raising your vehicle**

Make sure to observe the following to reduce the possibility of death or serious injury.

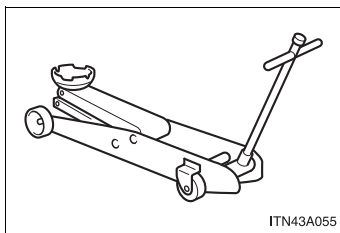

l Lift up the vehicle using a floor jack such as the one shown in the illustration.

- l** When using a floor jack, follow the instructions of the manual provided with the jack.
- l** Do not use the jack that was supplied with your vehicle.
- l** Do not put any part of your body or get underneath the vehicle supported only by the floor jack.
- l** Always use floor jack and/or automotive jack stands on a solid, flat, level surface.
- l** Do not start the engine while the vehicle is supported by the floor jack.
- l** Stop the vehicle on level firm ground, firmly set the parking brake and put the shift lever in "P".
- l** Make sure to set the floor jack properly at the jack point. Raising the vehicle with an improperly positioned floor jack will damage the vehicle and may cause the vehicle to fall off the floor jack.
- l** Do not raise the vehicle while someone is in the vehicle.
- l** When raising the vehicle, do not place any objects on top of or underneath the floor jack.

4-3. Do-it-yourself maintenance Engine compartment

▶ 2GR-FE engine

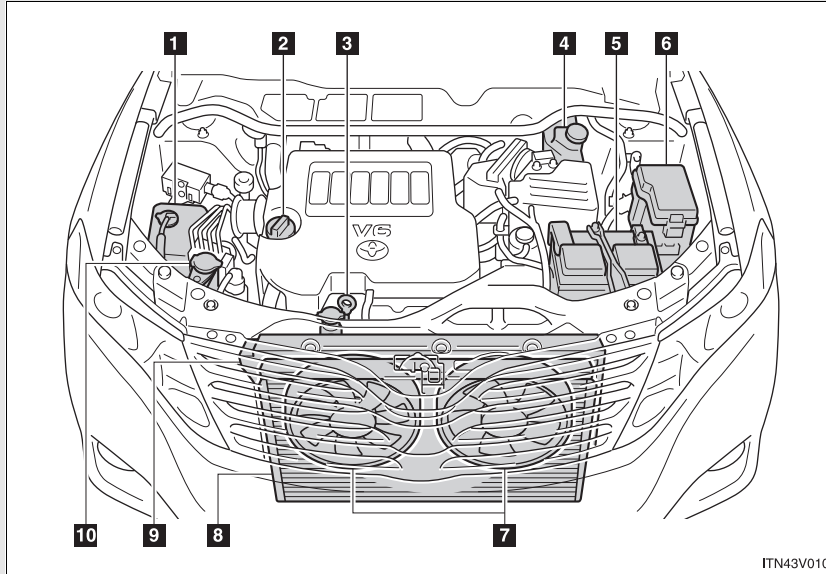

- | | |
|---|--|
| 1 Engine coolant reservoir
(→P. 497) | 5 Battery
(→P. 502) |
| 2 Engine oil filler cap
(→P. 494) | 6 Fuse box
(→P. 527) |
| 3 Engine oil level dipstick
(→P. 492) | 7 Electric cooling fans |
| 4 Brake fluid reservoir
(→P. 500) | 8 Condenser
(→P. 499) |
| | 9 Radiator
(→P. 499) |
| | 10 Washer fluid tank
(→P. 505) |

4-3. Do-it-yourself maintenance

► 1AR-FE engine

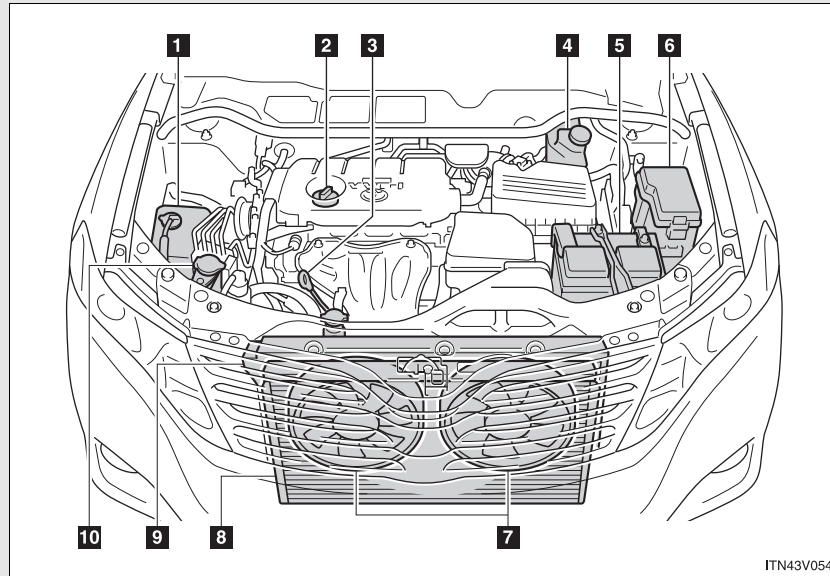

- | | |
|---|--|
| 1 Engine coolant reservoir
(→P. 497) | 5 Battery
(→P. 502) |
| 2 Engine oil filler cap
(→P. 494) | 6 Fuse box
(→P. 527) |
| 3 Engine oil level dipstick
(→P. 492) | 7 Electric cooling fans |
| 4 Brake fluid reservoir
(→P. 500) | 8 Condenser
(→P. 499) |
| | 9 Radiator
(→P. 499) |
| | 10 Washer fluid tank
(→P. 505) |

4

Maintenance and care

4-3. Do-it-yourself maintenance

Engine oil

With the engine at operating temperature and turned off, check the oil level on the dipstick.

n **Checking the engine oil**

STEP 1 Park the vehicle on level ground. After turning off the engine, wait more than five minutes for the oil to drain back into the bottom of the engine.

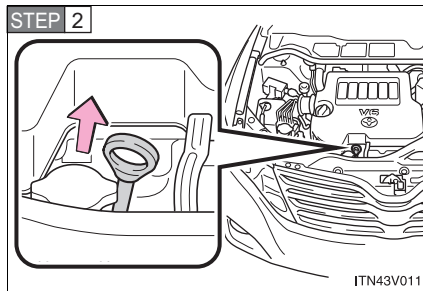

STEP 2 Hold a rag under the end and pull the dipstick out.

STEP 3 Wipe the dipstick clean.

STEP 4 Reinsert the dipstick fully.

STEP 5 Holding a rag under the end, pull the dipstick out and check the oil level.

4-3. Do-it-yourself maintenance

STEP 6 Wipe the dipstick and reinsert it fully.

► 2GR-FE engine

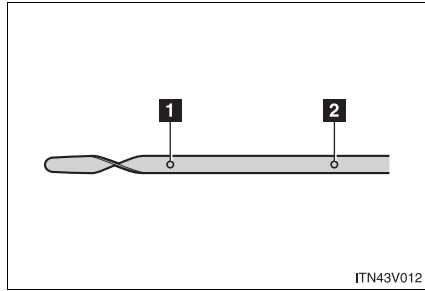

1 Low

2 Full

► 1AR-FE engine

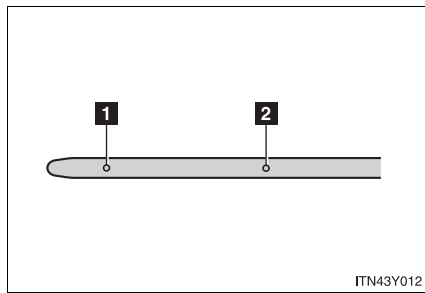

4

Maintenance and care

4-3. Do-it-yourself maintenance

n Adding engine oil

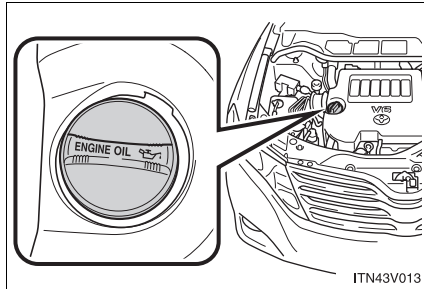

If the oil level is below or near the low level mark, add engine oil of the same type as already in the engine.

Make sure to check the oil type and prepare the items needed before adding oil.

Engine oil selection	→P. 612
Oil quantity (Low → Full)	1.6 qt. (1.5 L, 1.3 Imp. qt.)
Items	Clean funnel

STEP 1 Remove the oil filler cap.

STEP 2 Add engine oil slowly, checking the dipstick.

STEP 3 Install the filler cap, turning it clockwise.

4-3. Do-it-yourself maintenance

n Engine oil consumption

- l The amount of engine oil consumed depends on the oil viscosity, the quality of the oil and the way the vehicle is driven.
- l More oil is consumed under driving conditions such as high speeds and frequent acceleration and deceleration.
- l A new engine consumes more oil.
- l When judging the amount of oil consumption, keep in mind that the oil may have become diluted, making it difficult to judge the true level accurately.
- l Oil consumption: Max. 1.1 qt./600 miles, 0.9 Imp.qt./600 miles (1.0 L per 1000 km)
- l If you consume more than 1.1 qt. (1.0 L, 0.9 Imp.qt.) every 600 miles (1000 km), contact your Toyota dealer.

n After changing the engine oil (U.S.A. only)

The oil change system should be reset. Perform the following procedures:

- STEP 1** Switch the display to the trip meter A when the engine is running.
(→P. 175)
- STEP 2** Vehicles with smart key system:
Turn the “ENGINE START STOP” switch off.
Vehicles without smart key system:
Turn the engine switch to the “LOCK” position.

4

Maintenance and care

4-3. Do-it-yourself maintenance

STEP 3 Vehicles with smart key system:

While pressing the trip meter reset button, set the “ENGINE START STOP” switch to IGNITION ON mode (but do not start the engine because otherwise the reset mode will be canceled). Continue to press and hold the trip meter reset button until the trip meter displays “000000”.

Vehicles without smart key system:

While pressing the trip meter reset button, set the engine switch to “ON” position (but do not start the engine because otherwise the reset mode will be canceled). Continue to press and hold the trip meter reset button until the trip meter displays “000000”.

CAUTION**n Used engine oil**

- I** Used engine oil contains potentially harmful contaminants which may cause skin disorders such as inflammation or skin cancer, so care should be taken to avoid prolonged and repeated contact. To remove used engine oil from your skin, wash thoroughly with soap and water.
- I** Dispose of used oil and filters only in a safe and acceptable manner. Do not dispose of used oil and filters in household trash, in sewers or onto the ground.
Call your Toyota dealer, service station or auto parts store for information concerning recycling or disposal.
- I** Do not leave used engine oil within the reach of children.

 NOTICE

n To prevent serious engine damage

Check the oil level on regular basis.

n When replacing the engine oil

- !** Be careful not to spill engine oil on the vehicle components.
- !** Avoid overfilling, or the engine could be damaged.
- !** Check the oil level on the dipstick every time you refill the vehicle.
- !** Be sure the engine oil filler cap is properly retightened.

Engine coolant

The coolant level is satisfactory if it is between the “F” and “L” lines on the reservoir when the engine is cold.

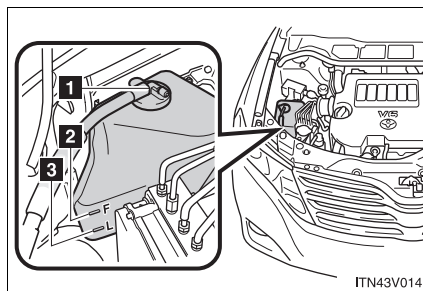

1 Reservoir cap

2 Full

3 Low

If the level is on or below the “L” line, add coolant up to the “F” line.

4-3. Do-it-yourself maintenance

n If the coolant level drops within a short time after replenishing

Visually check the radiator, hoses, reservoir cap, radiator cap, drain cock and water pump.

If you cannot find a leak, have your Toyota dealer pressure test the cap and check for leaks in the cooling system.

n Coolant selection

Only use "Toyota Super Long Life Coolant" or similar high quality ethylene glycol based non-silicate, non-amine, non-nitrite, and non-borate coolant with long-life hybrid organic acid technology.

U.S.A.: "Toyota Super Long Life Coolant" is a mixture of 50% coolant and 50% deionized water. (Enabled: -31°F [-35°C])

Canada: "Toyota Super Long Life Coolant" is a mixture of 55% coolant and 45% deionized water. (Enabled: -44°F [-42°C])

For more details about engine coolant, contact your Toyota dealer.

! CAUTION

n When the engine is hot

Do not remove the radiator cap.

The cooling system may be under pressure and may spray hot coolant if the cap is removed, causing burns or other injuries.

4-3. Do-it-yourself maintenance

NOTICE

n When adding the engine coolant

Coolant is neither plain water nor straight antifreeze. The correct mixture of water and antifreeze must be used to provide proper lubrication, corrosion protection and cooling. Be sure to read the antifreeze or coolant label.

n If you spill coolant

Be sure to wash it off with water to prevent it damage to parts or paint.

Radiator and condenser

Check the radiator and condenser and clear any foreign objects. If either of the above parts are extremely dirty or you are not sure of their condition, have your vehicle checked by your Toyota dealer.

CAUTION

n When the engine is hot

Do not touch the radiator or condenser as they may be hot and you may be burned.

4

Maintenance and care

4-3. Do-it-yourself maintenance

Brake fluid

▮ Checking fluid level

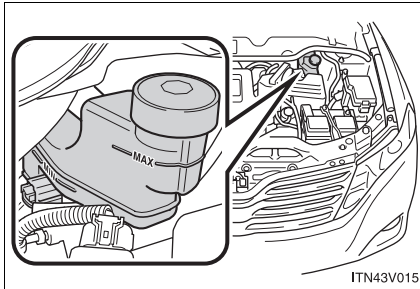

The brake fluid level should be between the “MAX” and “MIN” lines on the tank.

Make sure to check the fluid type and prepare the necessary items.

▮ Adding fluid

Fluid type	FMVSS No.116 DOT 3 or SAE J1703 brake fluid
Items	Clean funnel

4-3. Do-it-yourself maintenance

n Brake fluid can absorb moisture from the air

Excess moisture in the fluid can cause a dangerous loss of braking efficiency. Use only newly opened brake fluid.

⚠ CAUTION

n When filling the reservoir

Take care because brake fluid can harm your hands or eyes and damage painted surfaces.

If fluid gets in your eyes, flush your eyes with clean water immediately.

If you still experience discomfort, see a doctor.

⚠ NOTICE

n If the fluid level is low

It is normal for the brake fluid level to go down slightly as the brake pads wear or when the fluid level in the accumulator is high.

If the reservoir needs frequent refilling, it may indicate a serious problem.

4-3. Do-it-yourself maintenance

Battery

n Battery exterior

Make sure that the battery terminals are not corroded and that there are no loose connections, cracks, or loose clamps.

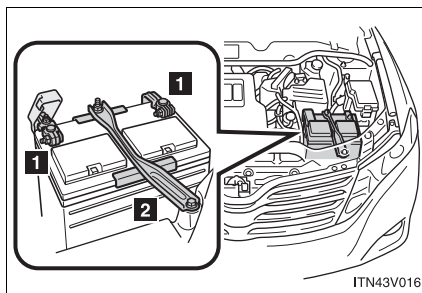

1 Terminals

2 Hold-down clamp

n **Before recharging**

When recharging, the battery produces hydrogen gas which is flammable and explosive. Therefore, before recharging:

- l If recharging with the battery installed on the vehicle, be sure to disconnect the ground cable.
- l Make sure the power switch on the charger is off when connecting and disconnecting the charger cables to the battery.

n **After recharging the battery (vehicles with smart key system)**

The engine may not start. Follow the procedure below to initialize the system.

- STEP 1** Depress the brake pedal with the shift lever in "N".
- STEP 2** Open and close any of the doors.
- STEP 3** Restart the engine.

! CAUTION

n **Chemicals in the battery**

A battery contains poisonous and corrosive sulfuric acid and may produce hydrogen gas which is flammable and explosive. To reduce the risk of death or serious injury, take the following precautions while working on or near battery:

- l Do not cause sparks by touching the battery terminals with tools.
- l Do not smoke or light a match near the battery.
- l Avoid contact with eyes, skin and clothes.
- l Never inhale or swallow electrolyte.
- l Wear protective safety glasses when working near the battery.
- l Keep children away from the battery.

4-3. Do-it-yourself maintenance

CAUTION

n Where to safely charge the battery

Always charge the battery in an open area. Do not charge the battery in a garage or closed room where there is not sufficient ventilation.

n How to recharge the battery

Only perform a slow charge (5 A or less). The battery may explode if charged at a quicker rate.

n Emergency measures regarding electrolyte

I If electrolyte gets in your eyes

Flush your eyes with clean water for at least 15 minutes and get immediate medical attention. If possible, continue to apply water with a sponge or cloth while traveling to the nearest medical facility.

I If electrolyte gets on your skin

Wash the affected area thoroughly. If you feel pain or a burning sensation, seek medical attention immediately.

I If electrolyte gets on your clothes

It can soak through clothing on to your skin. Immediately take off the clothing and follow the procedure above if necessary.

I If you accidentally swallow electrolyte

Drink a large quantity of water or milk. Follow with milk of magnesia, beaten raw egg or vegetable oil. Get emergency medical attention immediately.

NOTICE

n When recharging the battery

Never recharge the battery while the engine is running. Also, be sure all accessories are turned off.

Washer fluid

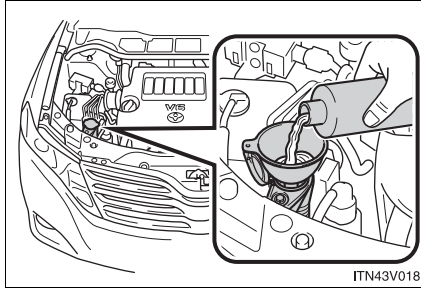

If any washer does not work or the low windshield washer fluid level warning light comes on, the washer tank may be empty. Add washer fluid.

CAUTION

n When refilling the washer fluid

Do not refill the washer fluid when the engine is hot or running, as the washer fluid contains alcohol and may catch fire if spilled on the engine etc.

NOTICE

n Do not use any fluid other than washer fluid

Do not use soapy water or engine antifreeze instead of washer fluid. Doing so may cause streaking on the vehicle's painted surfaces.

n Diluting washer fluid

Dilute washer fluid with water as necessary. Refer to the freezing temperatures listed on the washer fluid tank.

4-3. Do-it-yourself maintenance

Tires

Replace or rotate tires in accordance with maintenance schedules and treadwear.

n Checking tires

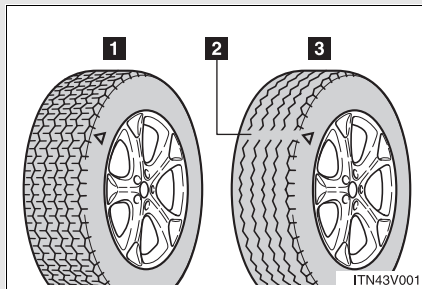

- 1 New tread
- 2 Treadwear indicator
- 3 Worn tread

The location of treadwear indicators is shown by the “TWI” or “Δ” marks, etc., molded on the sidewall of each tire.

Check spare tire condition and inflation pressure if not rotated.

n Tire rotation

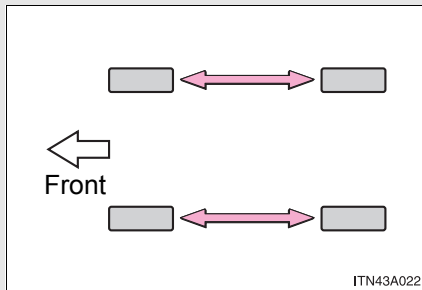

Rotate the tires in the order shown.

To equalize tire wear and extend tire life, Toyota recommends that tire rotation is carried out at the same interval as tire inspection.

n The tire pressure warning system

Your Toyota is equipped with a tire pressure warning system that uses tire pressure warning valves and transmitters to detect low tire inflation pressure before serious problems arise. (→P. 563)

The compact spare tire is not equipped with a tire pressure warning valve and transmitter.

Installing tire pressure warning valves and transmitters

When replacing tires or wheels, tire pressure warning valves and transmitters must also be installed.

When new tire pressure warning valves and transmitters are installed, new tire pressure warning valve and transmitter ID codes must be registered in the tire pressure warning computer and the tire pressure warning system must be initialized. Have tire pressure warning valve and transmitter ID codes registered by your Toyota dealer.

Registering ID codes

The tire pressure warning valve and transmitter is equipped with a unique ID code. When replacing a tire pressure warning valve and transmitter, it is necessary to register the ID code of tire pressure warning valve and transmitter. Have the ID code registered by your Toyota dealer.

4-3. Do-it-yourself maintenance

n **When to replace your vehicle's tires**

Tires should be replaced if:

- l You have tire damage such as cuts, splits, cracks deep enough to expose the fabric or bulges indicating internal damage
- l A tire goes flat repeatedly or cannot be properly repaired due to the size or location of a cut or other damage

If you are not sure, consult with your Toyota dealer.

n **Replacing tires and wheels**

If the ID code of the tire pressure warning valve and transmitter is not registered, the tire pressure warning system will not work properly. After driving for about 20 minutes, the tire pressure warning light comes on after blinking for 1 minute to indicate a system malfunction.

n **Tire life**

Any tire over 6 years old must be checked by a qualified technician even if they have seldom or never been used or damage is not obvious.

n **If the tread wears down below 0.16 in. (4 mm) on snow tires**

The effectiveness of snow tires is lost.

n **Maximum load of tire**

Check that the number given by dividing the maximum load by 1.10 of the replacement tire is greater than 1/2 of the Gross Axle Weight Ratings (GAWR) of either the front axle or the rear axle, whichever is greater.

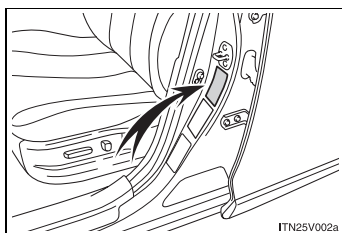

For the GAWR, see the Certification Label. For the maximum load of the tire, see the load limit at maximum cold tire inflation pressure mentioned on the sidewall of the tire. (→P. 625)

4-3. Do-it-yourself maintenance

n Tire types

1 Summer tires

Summer tires are high-speed performance tires best suited to highway driving under dry conditions. Since summer tires do not have the same traction performance as snow tires, summer tires are inadequate for driving on snow-covered or icy roads. For driving on snow-covered roads or icy roads, the use of snow tires is recommended. When installing snow tires, be sure to replace all four tires.

2 All season tires

All season tires are designed to provide better traction in snow and to be adequate for driving in most winter conditions, as well as for use year round. All season tires, however, do not have adequate traction performance compared with snow tires in heavy or loose snow. Also, all season tires fall short in acceleration and handling performance compared with summer tires in highway driving.

3 Snow tires

For driving on snow-covered roads or icy roads, we recommend using snow tires. If you need snow tires, select tires of the same size, construction and load capacity as the originally installed tires. Since your vehicle has radial tires as original equipment, make sure your snow tires also have radial construction. Do not install studded tires without first checking local regulations for possible restriction. Snow tires should be installed on all wheels. (→P. 242)

4-3. Do-it-yourself maintenance

n **Routine tire inflation pressure checks**

The tire pressure warning system does not replace routine tire inflation pressure checks. Make sure to check tire inflation pressure as part of your routine of daily vehicle checks.

n **Tire pressure warning system certification**

- For vehicles sold in the U.S.A.

FCC ID: PAXPMV107J

FCC ID: HYQ13BCX

This device complies with part 15 of the FCC Rules. Operation is subject to the following two conditions: (1) This device may not cause harmful interference, and (2) this device must accept any interference received, including interference that may cause undesired operation.

FCC WARNING

Changes or modifications not expressly approved by the party responsible for compliance could void the user's authority to operate the equipment.

4-3. Do-it-yourself maintenance

► For vehicles sold in Canada

IC ID: 3729A-PMV107J

IC ID: 1551A-13BCX

Operation is subject to the following two conditions: (1) this device may not cause interference, and (2) this device must accept any interference, including interference that may cause undesired operation of the device.

⚠ CAUTION

n When inspecting or replacing tires

Observe the following precautions to prevent accidents. Failure to do so may cause damage to parts of the drive train, as well as dangerous handling characteristics, which may lead to an accident resulting in death or serious injury.

- ! Do not mix tires of different makes, models or tread patterns. Also, do not mix tires of remarkably different treadwear.
- ! Do not use tire sizes other than those recommended by Toyota.
- ! Do not mix differently constructed tires (radial, bias-belted, or bias-ply tires).
- ! Do not mix summer, all season and winter tires.
- ! Do not use tire that have been used on another vehicle.
Do not use tires if you do not know they were used previously.
- ! Do not tow the vehicle with the compact spare tire installed.

4

Maintenance and care

4-3. Do-it-yourself maintenance

NOTICE

n Repairing or replacing tires, wheels, tire pressure warning valves, transmitters and tire valve caps

I When removing or fitting the wheels, tires or the tire pressure warning valve and transmitter, contact your Toyota dealer as the tire pressure warning valve and transmitter may be damaged if not handled correctly.

I When replacing tire valve caps, do not use tire valve caps other than those specified. The cap may become stuck.

n To avoid damage to the tire pressure warning valves and transmitters

When a tire is repaired with liquid sealants, the tire pressure warning valve and transmitter may not operate properly. If a liquid sealant is used, contact your Toyota dealer or other qualified service shop as soon as possible. Make sure to replace the tire pressure warning valve and transmitter when replacing the tire (→P. 507)

n Driving on rough roads

Take particular care when driving on roads with loose surfaces or potholes.

These conditions may cause losses in tire inflation pressure, reducing the cushioning ability of the tires. In addition driving on rough roads may cause damage to the tires themselves, as well as the vehicle's wheels and body.

n If tire inflation pressures become low while driving

Do not continue driving, or your tires and/or wheels may be ruined.

4-3. Do-it-yourself maintenance

Tire inflation pressure

n Tire inflation pressure

The recommended cold tire inflation pressure and tire size is displayed on the tire and loading information label. (→P. 619)

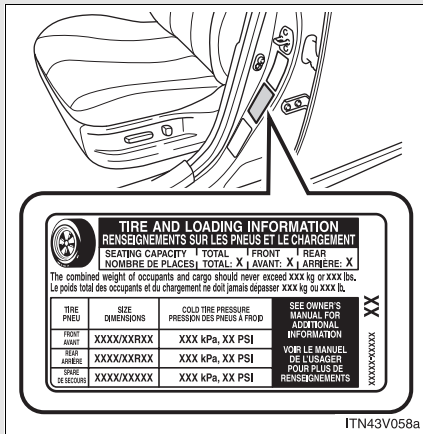

4-3. Do-it-yourself maintenance

n Inspection and adjustment procedure

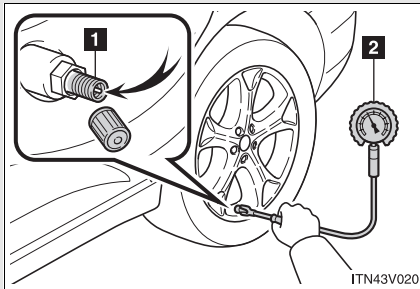

- 1 Tire valve
- 2 Tire pressure gauge

- STEP 1** Remove the tire valve cap.
- STEP 2** Press the tip of the tire pressure gauge onto the tire valve.
- STEP 3** Read the pressure using the graduations of the gauge.
- STEP 4** If the tire inflation pressure is not within the recommended levels, adjust tire pressure.
If you add too much air, press the center of the valve to lower.
- STEP 5** After completing the tire inflation pressure measurement and adjustment, apply soapy water to the valve and check for leakage.
- STEP 6** Reinstall the tire valve cap.

n Tire inflation pressure check interval

You should check tire inflation pressure every 2 weeks, or at least once a month.

Do not forget to check the spare.

4-3. Do-it-yourself maintenance

n **Effects of incorrect tire inflation pressure**

Driving with incorrect tire inflation pressure may result in the following:

- l Reduced fuel efficiency
- l Reduced driving comfort and tire life
- l Reduced safety
- l Damage to the drive train

If a tire needs frequent refilling, have it checked by your Toyota dealer.

n **Instructions for checking tire inflation pressure**

When checking tire inflation pressure, observe the following:

- l Check only when the tires are cold.
If your vehicle has been parked for at least 3 hours or has not been driven for more than 1 mile or 1.5 km, you will get an accurate cold tire inflation pressure reading.
- l Always use a tire pressure gauge.
The appearance of the tire can be misleading. In addition, tire inflation pressures that are even just a few pounds off can degrade ride and handling.
- l Do not bleed or reduce tire inflation pressure after driving. It is normal for the tire inflation pressure to be higher after driving.
- l Never exceed the vehicle capacity weight.
Passengers and luggage weight should be placed so that the vehicle is balanced.

4-3. Do-it-yourself maintenance

CAUTION

n Proper inflation is critical to save tire performance

Keep your tires properly inflated. Otherwise, the following conditions may occur and result in an accident causing death or serious injury.

- | Excessive wear
- | Uneven wear
- | Poor handling
- | Possibility of blowouts resulting from overheated tires
- | Poor sealing of the tire bead
- | Wheel deformation and/or tire separation
- | A greater possibility of tire damage from road hazards

NOTICE

n When inspecting and adjusting tire inflation pressure

Be sure to reinstall the tire valve caps.

Without the valve caps, dirt or moisture could get into the valve and cause air leakage, which could result in an accident. If the caps have been lost, replace them as soon as possible.

4-3. Do-it-yourself maintenance

Wheels

If a wheel is bent, cracked or heavily corroded, it should be replaced.

Otherwise, the tire may separate from the wheel or cause loss of handling control.

▮ **Wheel selection**

When replacing wheels, care should be taken to ensure that they are equivalent to those removed in load capacity, diameter, rim width, and inset*.

Replacement wheels are available at your Toyota dealer.

*: Conventionally referred to as "offset".

Toyota does not recommend using:

- 1 Wheels of different sizes or types
- 1 Used wheels
- 1 Bent wheels that have been straightened

▮ **Aluminum wheel precautions**

- 1 Use only Toyota wheel nuts and wrenches designed for use with your aluminum wheels.
- 1 When rotating, repairing or changing your tires, check that the wheel nuts are still tight after driving 1000 miles (1600 km).
- 1 Be careful not to damage the aluminum wheels when using tire chains.
- 1 Use only Toyota genuine balance weights or equivalent and a plastic or rubber hammer when balancing your wheels.

4-3. Do-it-yourself maintenance

n When replacing wheels

The wheels of your Toyota are equipped with tire pressure warning valves and transmitters that allow the tire pressure warning system to provide advanced warning in the event of a loss in tire inflation pressure. Whenever wheels are replaced, the tire pressure warning valves and transmitters must be installed. (→P. 507)

⚠ CAUTION**n When replacing wheels**

- ! Do not use wheels that are a different size from those recommended in the Owner's Manual, as this may result in loss of handling control.
- ! Never use an inner tube in a leaking wheel which is designed for a tubeless tire. Doing so may result in an accident, causing death or serious injury.

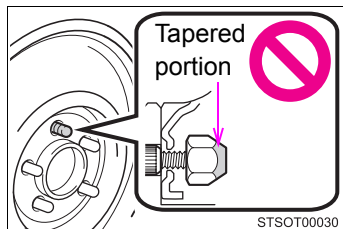
n When installing the wheel nuts

- ! Be sure to install the wheel nuts with the tapered end facing inward. Installing the nuts with the tapered end facing outward can cause wheel to break and eventually cause a wheel to come off while driving, which could lead to an accident resulting in death or serious injury.

- ! Never use oil or grease on the wheel bolts or wheel nuts. Oil and grease may cause the wheel nuts to be excessively tightened, leading to bolt or disc wheel damage. In addition, the oil or grease can cause the wheel nuts to loosen and the wheel may fall off, causing an accident and resulting in death or serious injury. Remove any oil or grease from the wheel bolts or wheel nuts.

4-3. Do-it-yourself maintenance

 NOTICE

n Replacing tire pressure warning valves and transmitters

I Because tire repair or replacement may affect the tire pressure warning valves and transmitters, make sure to have tires serviced by your Toyota dealer or other qualified service shop. In addition, make sure to purchase your tire pressure warning valves and transmitters at your Toyota dealer.

I Ensure that only genuine Toyota wheels are used on your vehicle. Tire pressure warning valves and transmitters may not work properly with non-genuine wheels.

4-3. Do-it-yourself maintenance

Air conditioning filter

The air conditioning filter must be cleaned or changed regularly to maintain air conditioning efficiency.

n Removal method

STEP 1 Vehicles with smart key system:

Turn the "ENGINE START STOP" switch off.

Vehicles without smart key system:

Turn the engine switch to the "LOCK" position.

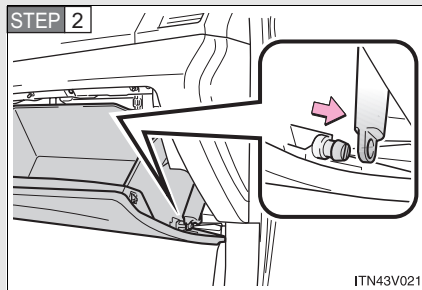

Open the glove box. Slide off the damper.

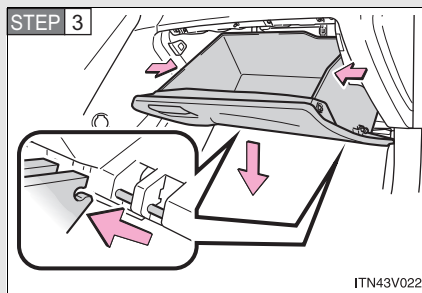

Push each side of the glove box to release the pins. Then disconnect the claws at the bottom and remove the glove box.

4-3. Do-it-yourself maintenance

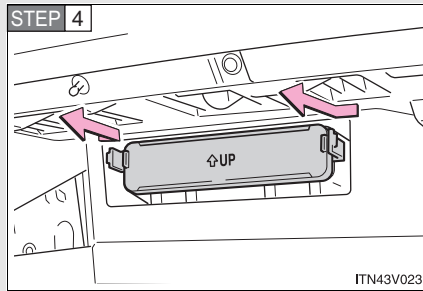

Remove the filter cover.

n Cleaning method

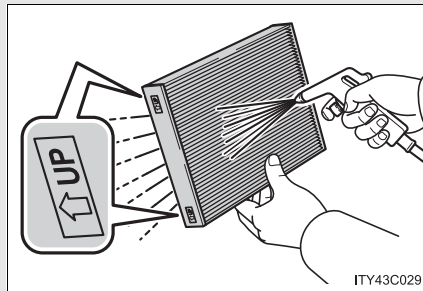

If the filter is dirty, clean by blowing compressed air through the filter from the downward side.

Hold the air gun 2 in. (5 cm) from the filter and blow for approximately 2 minutes at 72 psi (500 kpa, 5.0 kgf/cm² or bar).

If it is not available, have the filter cleaned by your Toyota dealer.

4

Maintenance and care

4-3. Do-it-yourself maintenance

n Replacement method

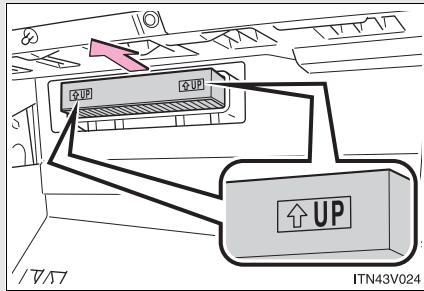

Remove the air conditioning filter and replace it with a new one.

The “↑UP” marks shown on the filter should be pointing up.

n Checking interval

Inspect, clean and replace the air conditioning filter according to the maintenance schedule. In dusty areas or areas with heavy traffic flow, more frequent cleaning or early replacement may be required. (For scheduled maintenance information, refer to the “Scheduled Maintenance Guide”, “Owner’s Manual Supplement”.)

n If air flow from the vents decreases dramatically

The filter may be clogged. Check the filter and replace if necessary.

⚠ NOTICE

n To prevent damage to the system

- ! When using the air conditioning system, make sure that a filter is always installed.
- ! When cleaning the filter, do not clean the filter with water.

4-3. Do-it-yourself maintenance

Key battery

Replace the battery with a new one if it is discharged.

n You will need the following items:

- 1 Flathead screwdriver (To prevent damage to the key, cover the tip of the screwdriver with rag.)
- 1 Small Phillips-head screwdriver
- 1 Lithium battery
Vehicles with smart key system: CR1632
Vehicles without smart key system: CR2025

n Replacing the battery (vehicles with smart key system)

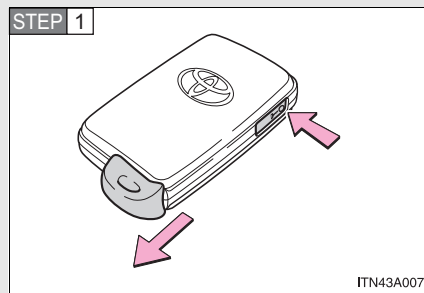

Take out the mechanical key.

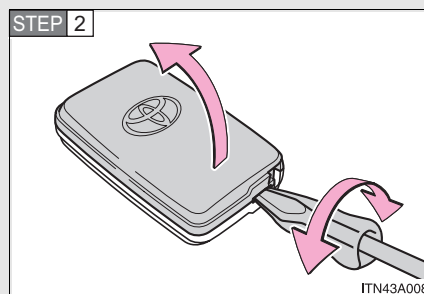

Remove the cover.

4-3. Do-it-yourself maintenance

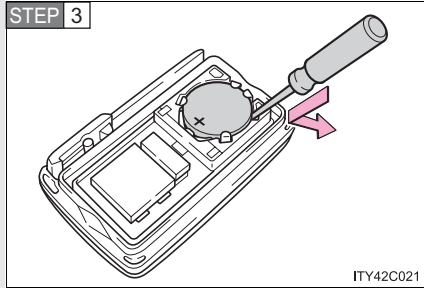

Remove the depleted battery.

Insert a new battery with the "+" terminal facing up.

n Replacing the battery (vehicles without smart key system)

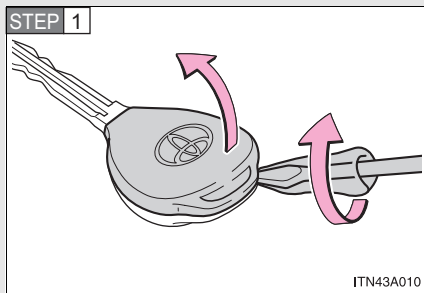

Remove the cover.

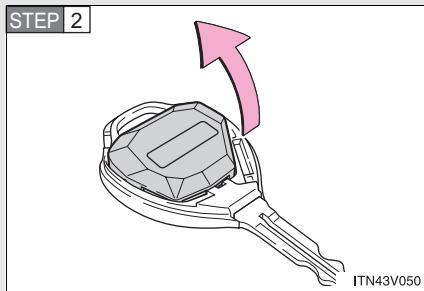

Remove the module.

4-3. Do-it-yourself maintenance

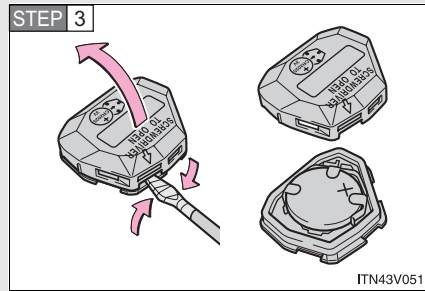

Open the case cover using a flathead screwdriver protected with tape etc. and remove the depleted battery.

Insert a new battery with the “+” terminal facing up.

n If the electronic key battery is discharged

The following symptoms may occur.

- l The smart key system and wireless remote control will not function properly.
- l The operational range is reduced.

n Use a CR1632 (vehicles with smart key system), or CR2025 (vehicles without smart key system) lithium battery

- l Batteries can be purchased at your Toyota dealer, jewelers, or camera stores.
- l Replace only with the same or equivalent type recommended by a Toyota dealer.
- l Dispose of used batteries according to the local laws.

4-3. Do-it-yourself maintenance

CAUTION

n Removed battery and other parts

Keep away from children. These parts are small and if swallowed by a child they can cause choking. Failure to do so could result in death or serious injury.

NOTICE

n For normal operation after replacing the battery

Observe the following precautions to prevent accidents.

- I** Always work with dry hands.
Moisture may cause the battery to rust.
- I** Do not touch or move any other components inside the electronic key.
- I** Do not bend the battery terminals.

4-3. Do-it-yourself maintenance

Checking and replacing fuses

If any of the electrical components do not operate, a fuse may have blown. If this happens, check and replace the fuses as necessary.

- STEP 1** Vehicles with smart key system:
Turn the “ENGINE START STOP” switch off.
Vehicles without smart key system:
Turn the engine switch to the “LOCK” position.

STEP 2 Open the fuse box cover.

► Engine compartment

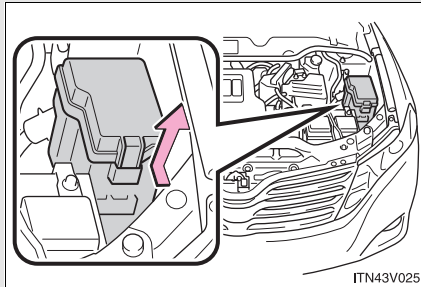

Push the tab in and lift the lid off.

► Driver's side instrument panel

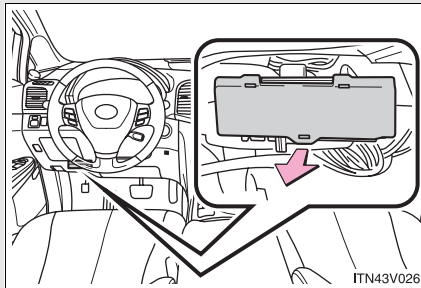

Remove the lid.

4-3. Do-it-yourself maintenance

STEP 3 After a system failure, see “Fuse layout and amperage ratings” (→P. 529) for details about which fuse to check.

STEP 4

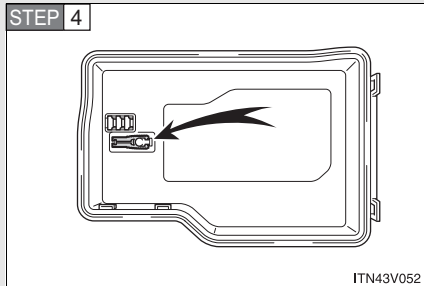

Remove the fuse with the pull-out tool.

STEP 5 Check if the fuse has blown.

► Type A

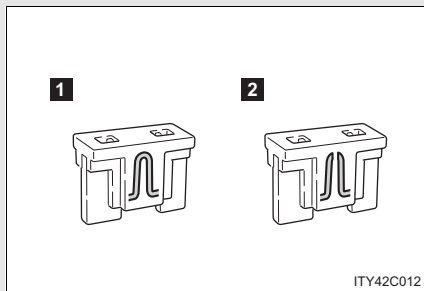

1 Normal fuse

2 Blown fuse

Replace it with one of an appropriate amperage rating. The amperage rating can be found on the fuse box lid.

► Type B

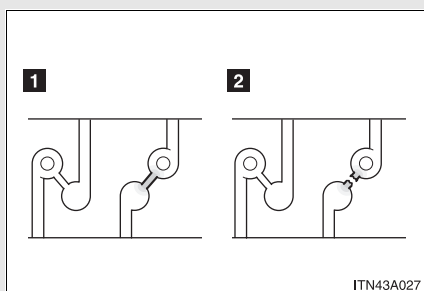

1 Normal fuse

2 Blown fuse

Contact your Toyota dealer.

4-3. Do-it-yourself maintenance

Fuse layout and amperage ratings

Engine compartment

► Fuse block

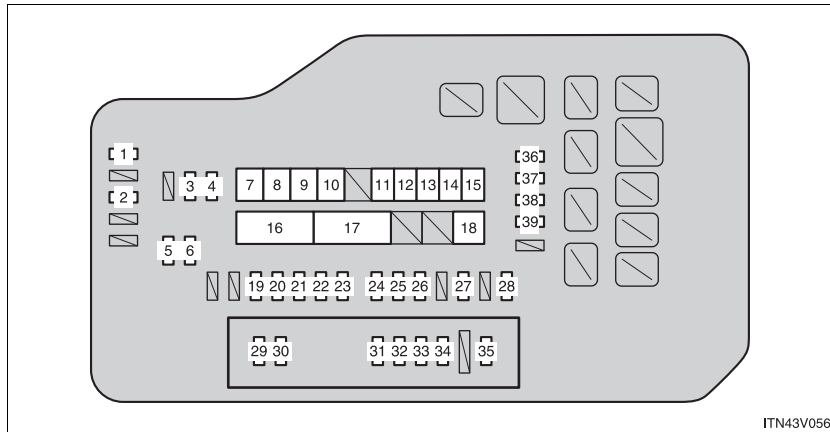

► Back of the cover

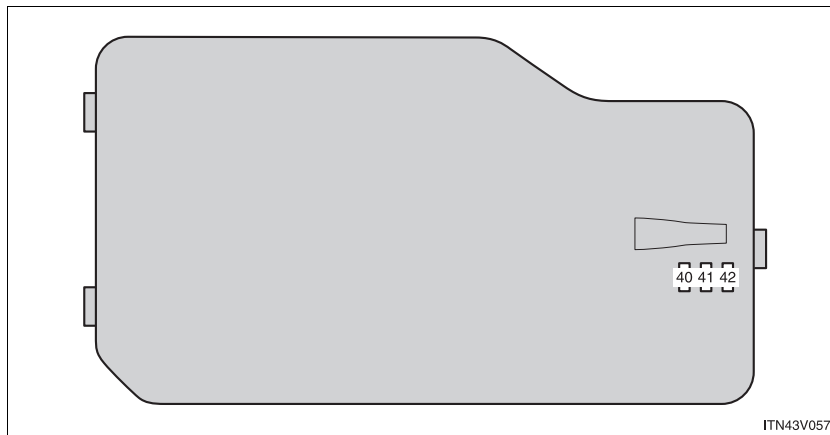

4

Maintenance and care

4-3. Do-it-yourself maintenance

Fuse		Ampere	Circuit
1	AC 115V	15 A	Power outlet
2	DEICER	20 A	Windshield wiper de-icer
3	INJ NO.1	15 A	Multi-port fuel injection system/ sequential multi-port fuel injection system
4	INJ NO.2	15 A	Igniter system
5	EFI NO.2	15 A	Multi-port fuel injection system/ sequential multi-port fuel injection system
6	EFI NO.3	10 A	Multi-port fuel injection system/ sequential multi-port fuel injection system
7	HEATER	50 A	Air conditioning system
8	ABS NO.1	50 A	Anti-lock brake system, vehicle stability control system
9	FAN MAIN*1	50 A	Electric cooling fan
10	ABS NO.2	30 A	Anti-lock brake system, vehicle stability control system
11	CDS FAN*2	30 A	Electric cooling fan
12	RDI FAN*2	30 A	Electric cooling fan
13	FAN MAIN*1	40 A	Electric cooling fan
14	PBD	30 A	Power back door
15	RR DEF	30 A	Rear window defogger
16	ALT	140 A*3 or 120 A*3	Charging system, HEATER, ABS NO.1, FAN MAIN, ABS NO.2, PBD, RR DEF, MIR HTR, DEICER
17	EPS	80 A	Electric power steering
18	ST/AM2	30 A	Starting system
19	DOOR NO.1	20 A	Power door lock system
20	STR LOCK	20 A	Steering lock system
21	SEC HORN	7.5 A	Alarm
22	AM2	7.5 A	Multiplex communication system, starting system
23	ALT-S	7.5 A	Charging system

4-3. Do-it-yourself maintenance

Fuse		Ampere	Circuit
24	EFI NO.1	10 A	Smart key system, multi-port fuel injection system/sequential multi-port fuel injection system, automatic transmission
25	ETCS	10 A	Multi-port fuel injection system/ sequential multi-port fuel injection system, electronic throttle control system
26	HAZ	15 A	Turn signal lights
27	IG2	25 A	INJ NO.1, INJ NO.2, SRS airbag system
28	RADIO NO.3	25 A	Audio system
29	A/F*1	20 A	Air fuel ratio sensor
	EFI MAIN*2	20 A	EFI NO.2, EFI NO.3
30	HORN	10 A	Horn
31	H-LP LH LO	15 A	Left-hand headlight (low beam)
32	H-LP RH LO	15 A	Right-hand headlight (low beam)
33	H-LP LH HI	15 A	Left-hand headlight (high beam)
34	H-LP RH HI	15 A	Right-hand headlight (high beam)
35	EFI MAIN*1	25 A	EFI NO.2, EFI NO.3
	EFI NO.4*2	20 A	Air fuel ratio sensor
36	DOME	7.5 A	Personal/interior lights, vanity lights, engine switch light, door courtesy lights, power back door, gauges and meters

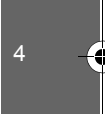

Maintenance and care

4-3. Do-it-yourself maintenance

Fuse		Ampere	Circuit
37	ECU-B	10 A	Gauges and meters, clock, audio system, main body ECU, wireless remote control, smart key system, power back door, front passenger occupant classification system
38	RSE	10 A	Rear seat entertainment system
39	RADIO NO.1	15 A	Audio system, navigation system
40	SPARE	7.5 A	Spare fuse
41	SPARE	15 A	Spare fuse
42	SPARE	25 A	Spare fuse

*1: Vehicles with 2GR-FE engine

*2: Vehicles with 1AR-FE engine

*3: Replace the fuse with one of the same ampere rating as the original.

4-3. Do-it-yourself maintenance

n Driver's side instrument panel

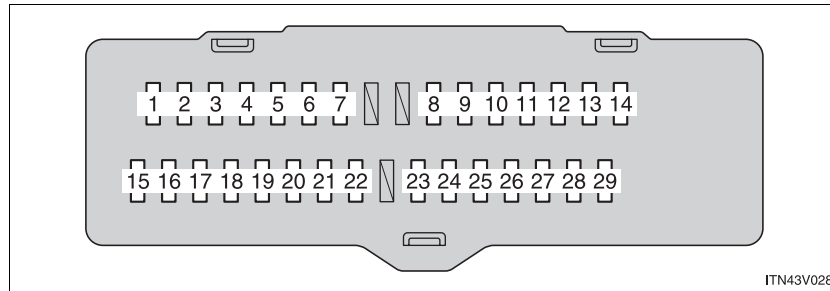

Fuse	Ampere	Circuit
1	20 A	RR DOOR
2	20 A	RL DOOR
3	20 A	FR DOOR
4	15 A	FR FOG
5	7.5 A	OBD
6	20 A	FL DOOR
7	10 A	STOP
8	7.5 A	AM1
9	7.5 A	ECU-B NO.2
10	7.5 A	4WD

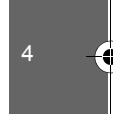

Maintenance and care

4-3. Do-it-yourself maintenance

Fuse		Ampere	Circuit
11	SEAT HTR	20 A	Seat heaters
12	S/ROOF	25 A	Electric moon roof
13	TAIL	10 A	Side marker lights, tail lights, license plate light
14	PANEL	5 A	Emergency flashers, audio system, clock, instrument panel light control, glove box light, console box light, steering switches, outside rear view mirror defoggers, seat heaters, vehicle stability control system, shift lever light
15	ECU-IG NO.1	10 A	Multiplex communication system, electric moon roof, power back door, seat heaters, Active Torque Control 4WD, audio system, Automatic High Beam
16	RR WASHER	15 A	Rear window washer
17	A/C NO.2	10 A	Air conditioning system
18	FR WASHER	20 A	Windshield washer
19	ECU-IG NO.2	7.5 A	Vehicle stability control system, automatic headlight leveling system, yaw rate & G sensor, steering sensor, shift lock system, tire pressure warning system, automatic transmission, electric power steering

4-3. Do-it-yourself maintenance

	Fuse	Ampere	Circuit
20	GAUGE NO.1	10 A	Navigation system, back-up lights, charging system, emergency flashers, multi-information display
21	FR WIPER	30 A	Windshield wipers
22	RR WIPER	15 A	Rear window wiper
23	IGN	10 A	Multi-port fuel injection system/ sequential multi-port fuel injection system, steering lock system, smart key system, SRS airbag system, front passenger occupant classification system
24	GAUGE NO.2	7.5 A	Gauges and meters, multi-information display, multiplex communication system
25	ECU-ACC	7.5 A	Power rear view mirrors
26	SHIFT LOCK	7.5 A	Shift lock system
27	PWR OUTLET NO.1	15 A	Power outlets
28	RADIO NO.2	7.5 A	Audio system, rear seat entertainment system
29	MIR HTR	10 A	Outside rear view mirror defoggers

4-3. Do-it-yourself maintenance

n **After a fuse is replaced**

- l If the lights do not turn on even after the fuse has been replaced, a bulb may need replacement. (→P. 537)
- l If the replaced fuse blows again, have the vehicle inspected by your Toyota dealer.

n **If there is an overload in the circuits**

The fuses are designed to blow, protecting the wiring harness from damage.

CAUTION

n **To prevent system breakdowns and vehicle fire**

Observe the following precautions.

Failing to do so may cause damage, and possibly a fire or injury.

- l Never use a fuse of a higher amperage rating than indicated, or use any other object in place of a fuse.
- l Always use a genuine Toyota fuse or equivalent.
Never replace a fuse with a wire, even as a temporary fix.
This can cause extensive damage or even fire.
- l Do not modify fuses or the fuse box.

NOTICE

n **Before replacing fuses**

Have the cause of electrical overload determined and repaired by your Toyota dealer.

4-3. Do-it-yourself maintenance

Light bulbs

You may replace the following bulbs yourself. The difficulty level of replacement varies depending on the bulb. If necessary bulb replacement seems difficult to perform, contact your Toyota dealer.

For more information about replacing other light bulbs, contact your Toyota dealer.

▮ **Prepare a replacement light bulb.**

Check the wattage of the light bulb being replaced. (→P. 621)

▮ **Turn the power back door main switch off. (vehicles with power back door)**

→P. 56

▮ **Front bulb locations**

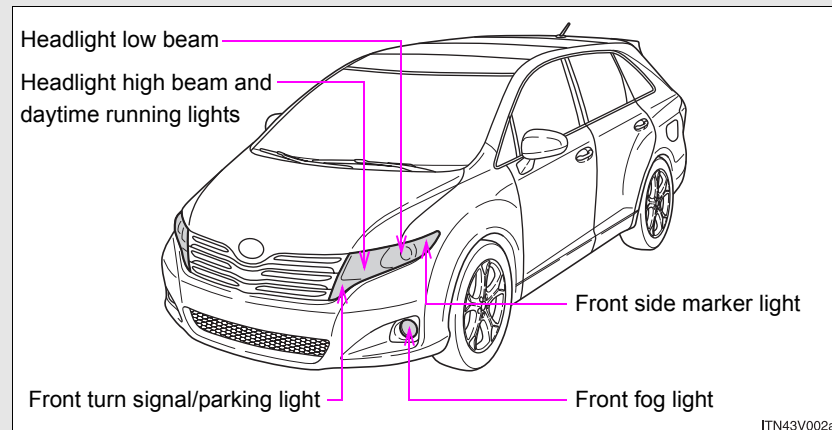

4-3. Do-it-yourself maintenance

n Rear bulb locations

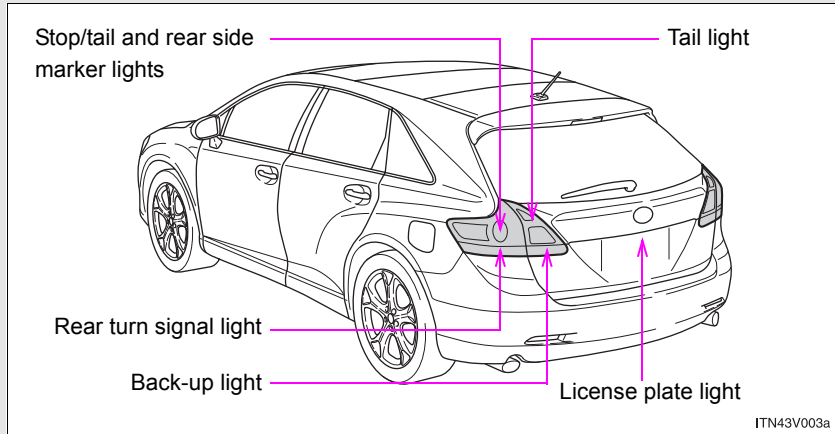

Replacing light bulbs

n Headlight low beams (halogen bulb)

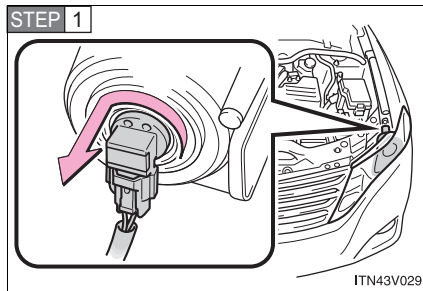

Turn the bulb base counterclockwise.

4-3. Do-it-yourself maintenance

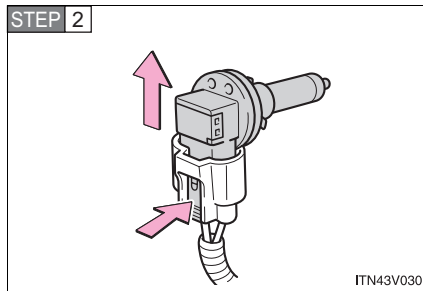

Unplug the connector while pushing the lock release.

n Headlight high beams and daytime running lights

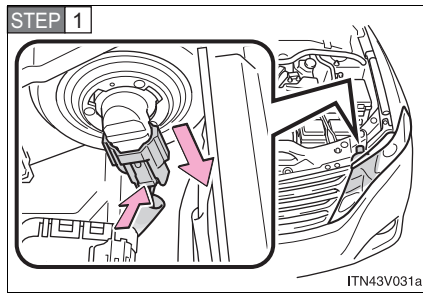

Unplug the connector while pushing the lock release.

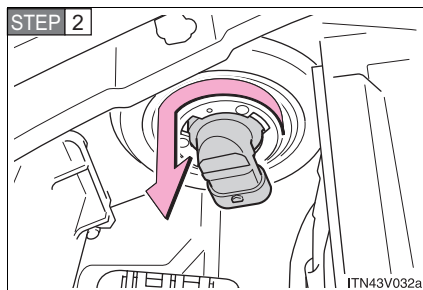

Turn the bulb base counterclockwise.

4-3. Do-it-yourself maintenance

n Front fog lights (if equipped)

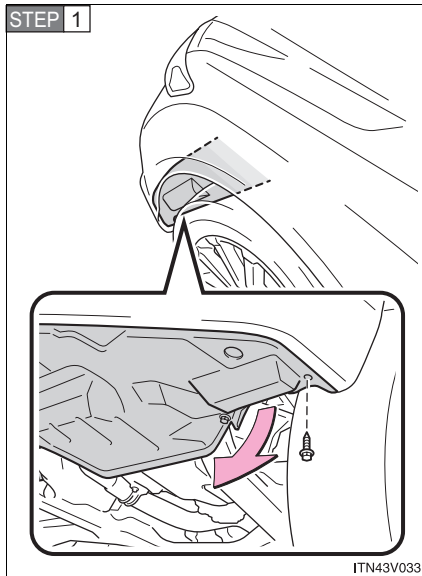

Remove the engine under cover bolt and pull down the engine under cover.

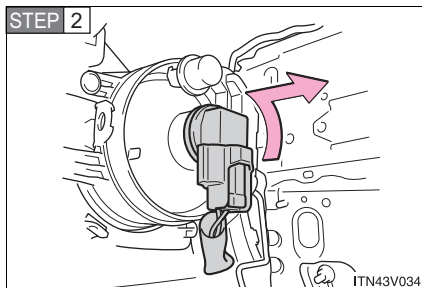

Turn the bulb base counterclockwise.

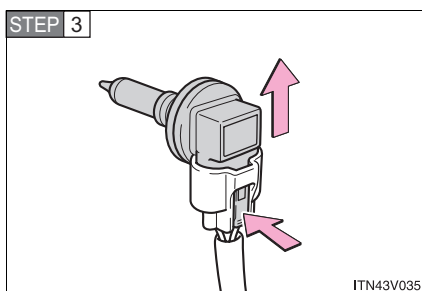

Unplug the connector while pushing the lock release.

4-3. Do-it-yourself maintenance

n Front turn signal/parking lights

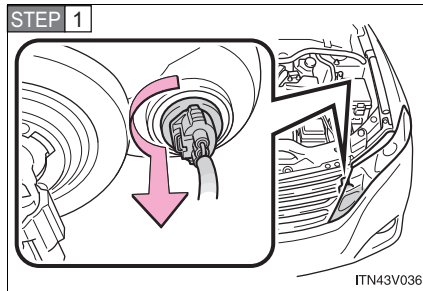

Turn the bulb base counterclockwise.

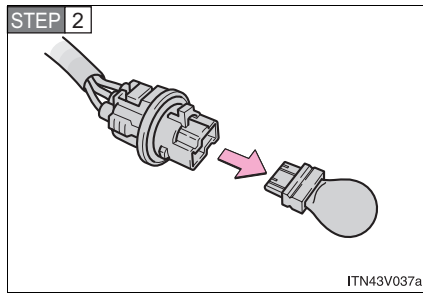

Remove the light bulb.

4-3. Do-it-yourself maintenance

n Front side marker lights

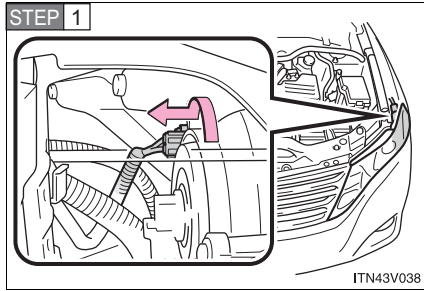

Turn the bulb base counterclockwise.

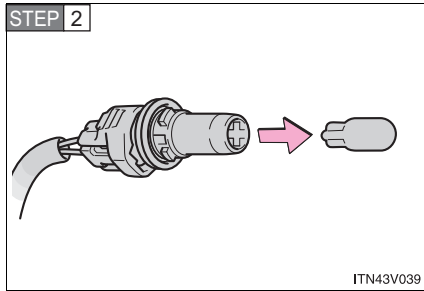

Remove the light bulb.

4-3. Do-it-yourself maintenance

n Rear turn signal lights, stop/tail and rear side marker lights

► **Left side**

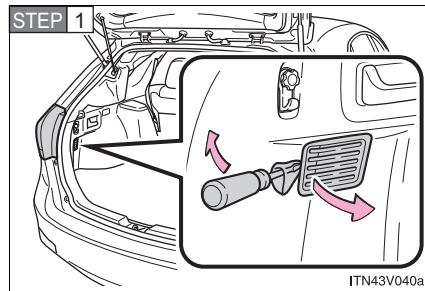

Open the back door and remove the cover.

To protect the cover, place a rag between the flathead screwdriver and cover as shown in the illustrations.

► **Right side**

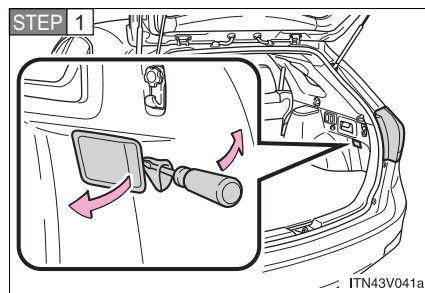

Open the back door and remove the cover.

To protect the cover, place a rag between the flathead screwdriver and cover as shown in the illustrations.

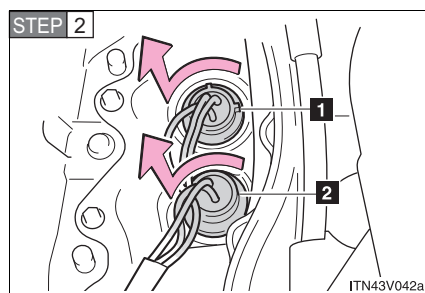

Turn the bulb base counterclockwise.

- 1** Stop/tail and rear side marker lights
- 2** Rear turn signal light

4-3. Do-it-yourself maintenance

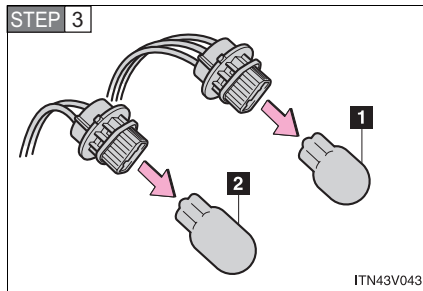

Remove the light bulb.

- 1** Stop/tail and rear side marker lights
- 2** Rear turn signal light

n Tail and back-up lights

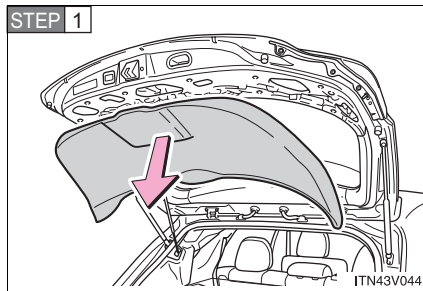

Open the back door and remove the trim board.

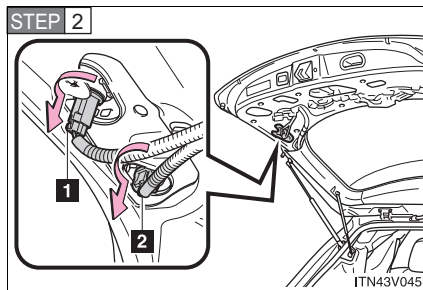

Turn the bulb base counterclockwise.

- 1** Back-up light
- 2** Tail light

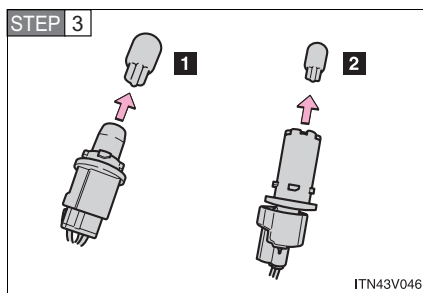

Remove the light bulb.

- 1** Back-up light
- 2** Tail light

4-3. Do-it-yourself maintenance

n License plate light

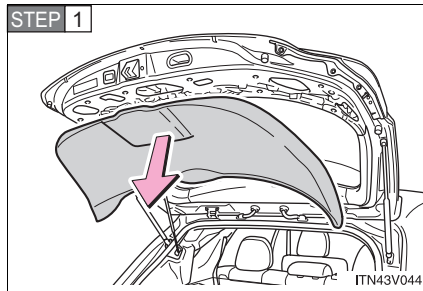

Open the back door and remove the trim board.

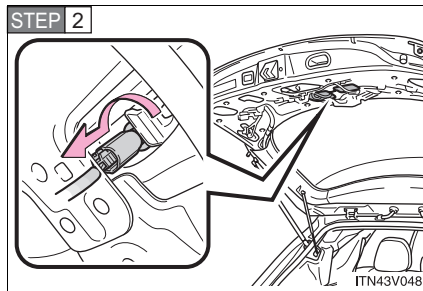

Turn the bulb base counterclockwise.

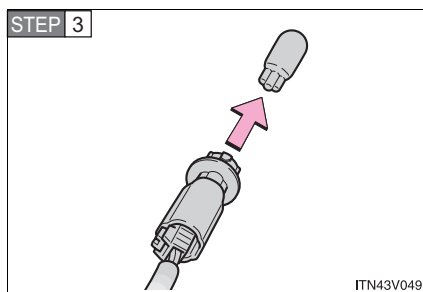

Remove the light bulb.

4-3. Do-it-yourself maintenance

n **Bulbs other than the above**

If any of the bulbs listed below has burnt out, have your Toyota dealer replace it.

- l Headlight low beams (discharge bulb)
- l High mounted stoplight

n **Condensation build-up on the inside of the lens**

Contact your Toyota dealer for more information in the following situations. Temporary condensation build-up on the inside of the headlight lens does not indicate a malfunction.

- l Large drops of water are built up on the inside of the lens.
- l Water has built up inside the headlight.

n **LED light bulbs**

The high mounted stoplight consists of a number of LEDs. If any LEDs burn out, take your vehicle to your Toyota dealer to have the light replaced.

n **High-intensity discharge (HID) headlights (if equipped)**

If voltage to the high-intensity discharge bulbs is insufficient, the light may not come on, or may go out temporarily. The high-intensity discharge bulbs will come on when normal power is restored.

⚠ CAUTION

n Replacing light bulbs

- I** Turn off the headlights. Do not attempt to replace the bulb immediately after turning off the headlights.
The bulbs become very hot and may cause burns.
- I** Do not touch the glass portion of the light bulb with bare hands. Hold the bulb by the plastic or metal portion.
If the bulb is scratched or dropped it may blow out or crack.
- I** Fully install light bulbs and any parts used to secure them. Failing to do so may result in heat damage, fire, or water entering the headlight unit. This may damage the headlights or cause condensation to build up on the lens.
- I** Do not attempt to repair or disassemble light bulbs, connectors, electric circuits or component parts.
Doing so may result in death or serious injury due to electric shock.

n High-intensity discharge (HID) headlights (if equipped)

- I** Contact your Toyota dealer before replacing high-intensity discharge headlights (including light bulbs).
- I** Do not touch the high-intensity discharge headlight's high voltage socket when the headlights are turned on. An extremely high voltage of 20000V will be discharged and could result in death or serious injury by electric shock.

n To prevent damage or fire

- Make sure bulbs are fully seated and locked.

4-3. Do-it-yourself maintenance

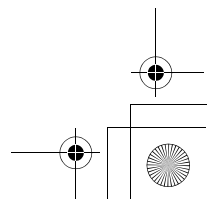
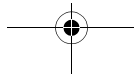
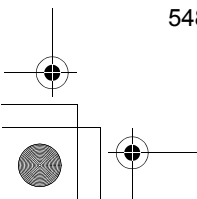
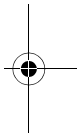
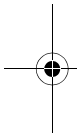

When trouble arises

5

5-1. Essential information

Emergency flashers	550
If your vehicle needs to be towed	551
If you think something is wrong	555
If noise can be heard from under vehicle	556
Fuel pump shut off system.....	557
Event data recorder	558

5-2. Steps to take

in an emergency

If a warning light turns on or a warning buzzer sounds... ..	560
If a warning message is displayed	575
If you have a flat tire.....	576
If the engine will not start.....	587
If the shift lever cannot be shifted from "P"	590
If you lose your keys	591
If the electronic key does not operate properly (vehicles with smart key system)	592
If the battery is discharged	595
If your vehicle overheats	600
If the vehicle becomes stuck.....	603
If your vehicle has to be stopped in an emergency	605

5-1. Essential information

Emergency flashers

Use the emergency flashers if the vehicle malfunctions or is involved in an accident.

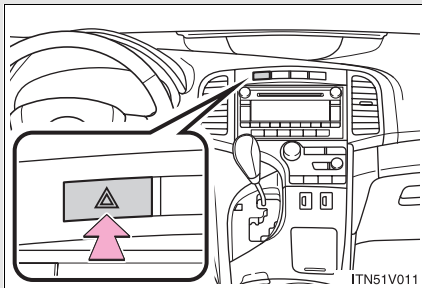

Press the switch to flash all the turn signal lights. To turn them off, press the switch once again.

NOTICE

n To prevent battery discharge

Do not leave the emergency flashers on longer than necessary when the engine is not running.

5-1. Essential information

If your vehicle needs to be towed

If towing is necessary, we recommend having your vehicle towed by your Toyota dealer or a commercial towing service, using a lift-type truck or a flat bed truck.

Use a safety chain system for all towing, and abide by all state/provincial and local laws.

▶ **2WD models**

If towing your vehicle with a wheel-lift type truck from the front, the vehicle's rear wheels and axles must be in good conditions. (→P. 552, 554)

If they are damaged, use a towing dolly or flat bed truck.

▶ **AWD models**

If towing your vehicle with a wheel-lift type truck, use a towing dolly. (→P. 552, 554)

Before towing

The following may indicate a problem with your transmission. Contact your Toyota dealer before towing.

- 1 The engine is running, but the vehicle will not move.
- 1 The vehicle makes an abnormal sound.

5-1. Essential information

Towing with a sling-type truck

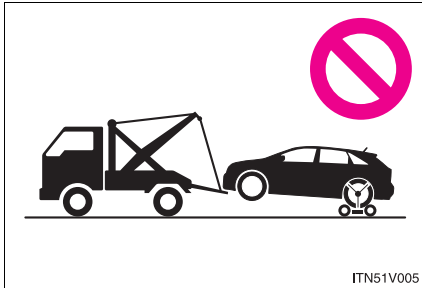

Towing with a wheel lift-type truck

- ▶ From the front (2WD models)

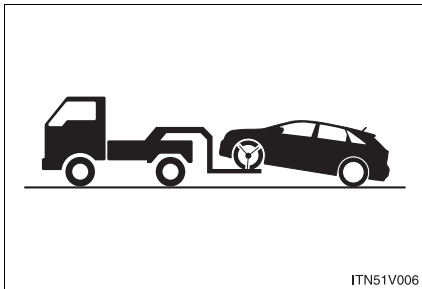

Release the parking brake.

- ▶ From the front (AWD models)

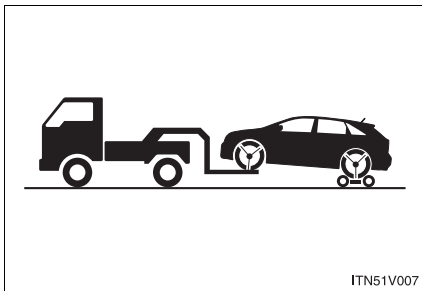

Use a towing dolly under the rear wheels.

5-1. Essential information

► From the rear

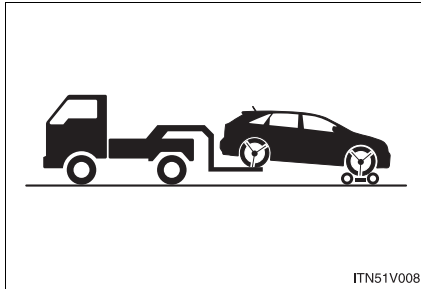

Use a towing dolly under the front wheels.

Using a flat bed truck

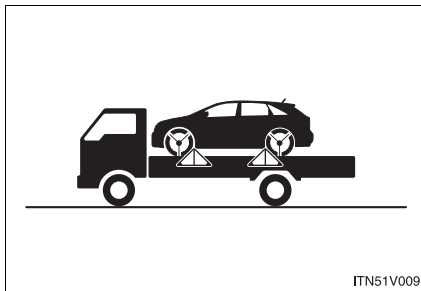

If you use chains or cables to tie down your vehicle, the angles shaded in black must be 45°.

Do not overly tighten the tie downs or the vehicle may be damaged.

5

When trouble arises

5-1. Essential information

 NOTICE

n To prevent body damage when towing a sling-type truck

Do not tow with a sling-type truck, either from the front or rear.

n To prevent causing serious damage to the transmission and Active Torque Control 4WD system (AWD models) when towing using a wheel-lift type truck

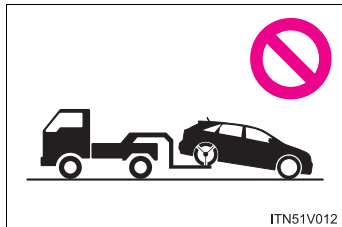

2WD models: Never tow this vehicle from the rear with the front wheels on the ground. This may cause serious damage to the transmission. If towing from the rear, use a towing dolly.

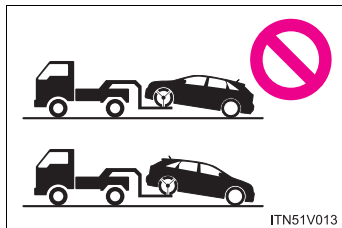

AWD models: Never tow this vehicle with any of the wheels on the ground. This may cause serious damage to the transmission and Active Torque Control 4WD system. Use a towing dolly.

n To prevent damaging the vehicle when towing using a wheel-lift type truck

When raising the vehicle, ensure adequate ground clearance for towing at the opposite end of the raised vehicle. Without adequate clearance, the vehicle could be damaged while being towed.

n Recreational towing (behind motor home, etc.)

Never dinghy tow your vehicle to prevent causing serious damage to the Active Torque Control 4WD system (AWD models) and transmission.
(→P. 259)

5-1. Essential information

If you think something is wrong

If you notice any of the following symptoms, your vehicle probably needs adjustment or repair. Contact your Toyota dealer as soon as possible.

n Visible symptoms

- 1 Fluid leaks under the vehicle
(Water dripping from the air conditioning after use is normal.)
- 1 Flat-looking tires or uneven tire wear
- 1 Engine coolant temperature gauge needle continually points higher than normal

n Audible symptoms

- 1 Changes in exhaust sound
- 1 Excessive tire squeal when cornering
- 1 Strange noises related to the suspension system
- 1 Pinging or other noises related to the engine

n Operational symptoms

- 1 Engine missing, stumbling or running rough
- 1 Appreciable loss of power
- 1 Vehicle pulls heavily to one side when braking
- 1 Vehicle pulls heavily to one side when driving on a level road
- 1 Loss of brake effectiveness, spongy feeling, pedal almost touches the floor

5-1. Essential information

If noise can be heard from under vehicle

Approximately five hours after the engine is turned off, you may hear sound coming from under the vehicle for several minutes. This is the sound of a fuel evaporation leakage check and, it does not indicate a malfunction.

5-1. Essential information

Fuel pump shut off system

To minimize the risk of fuel leakage when the engine stalls or an air-bag inflates upon collision, the fuel pump shut off system stops supplying fuel to the engine.

Follow the procedure below to restart the engine after the system is activated.

► Vehicles with smart key system

STEP 1 Turn the “ENGINE START STOP” switch to ACCESSORY mode or off.

STEP 2 Restart the engine.

► Vehicles without smart key system

STEP 1 Turn the engine switch to the “ACC” or “LOCK” position.

STEP 2 Restart the engine.

 NOTICE

n Before starting the engine

Inspect the ground under the vehicle.

If you find that fuel has leaked on to the ground, the fuel system has been damaged and is in need of repair. Do not restart the engine.

5

When trouble arises

5-1. Essential information

Event data recorder

Your vehicle has computers that monitor and control certain aspects of your vehicle. These computers assist in driving and maintaining optimal vehicle performance.

Besides storing data useful for troubleshooting, there is a system to record data in a crash or a near car crash event. This is called an Event Data Recorder (EDR).

In a crash or a near car crash event

The SRS airbag sensor assembly contains the EDR. In a crash or a near car crash event, this device may record some or all of the following information:

- 1 Engine speed
- 1 Whether the brake pedal was applied or not
- 1 Vehicle speed
- 1 To what extent the accelerator pedal was depressed
- 1 Position of the transmission shift lever
- 1 Whether the driver and front passenger wore seat belts or not
- 1 Driver's seat position
- 1 Front passenger's occupant classification
- 1 SRS airbag deployment data
- 1 SRS airbag system diagnostic data

The information above is intended to be used for the purpose of improving vehicle safety performance. Unlike general data recorders, the EDR does not record sound data such as conversation between passengers.

5-1. Essential information

Disclosure of the data

Toyota will not disclose the data recorded in an EDR to a third party except when:

- 1 An agreement from the vehicle's owner (or the leasing company for a leased vehicle) is obtained
- 1 Officially requested by the police or other authorities
- 1 Used as a defense for Toyota in a law suit
- 1 Ordered by a court

However, if necessary Toyota will:

- 1 Use the data for research on Toyota vehicle safety performance
- 1 Disclose the data to a third party for research purposes without disclosing details of the vehicle owner, and only when it is deemed necessary
- 1 Disclose summarized data cleared of vehicle identification information to a non-Toyota organization for research purposes



5-2. Steps to take in an emergency

If a warning light turns on or a warning buzzer sounds...

Calmly perform the following actions if any of the warning lights turn on or flash. If a light turns on or flashes, but then turns off, this does not necessarily indicate a malfunction in the system.

Stop the vehicle immediately. Continuing to drive the vehicle may be dangerous.

The following warning indicates a possible problem in the brake system. Immediately stop the vehicle in a safe place and contact your Toyota dealer.

Warning light	Warning light/Details
 (U.S.A.)	Brake system warning light (warning buzzer)* <ul style="list-style-type: none"> • Low brake fluid • Malfunction in the brake system This light also comes on when the parking brake is not released. If the light turns off after the parking brake is fully released, the system is operating normally.
 (Canada)	



*: Parking brake engaged warning buzzer:

A buzzer will sound if the vehicle is driven at a speed of approximately 3 mph (5 km/h) or more.

5-2. Steps to take in an emergency

Stop the vehicle immediately.

The following warning indicates the possibility of damage to the vehicle that may lead to an accident. Immediately stop the vehicle in a safe place and contact your Toyota dealer.

Warning light	Warning light/Details
	Charging system warning light Malfunction in the vehicle's charging system.
	Low engine oil pressure warning light Abnormal level of engine oil pressure. This warning light may turn on if the level of engine oil declines. The light should turn off after checking the oil and adding oil if necessary.

Have the vehicle inspected immediately.





Failing to investigate the cause of the following warnings may lead to the system operating abnormally and possibly cause an accident. Have the vehicle inspected by your Toyota dealer immediately.

Warning light	Warning light/Details
	Malfunction indicator lamp Malfunction in: <ul style="list-style-type: none"> • The emission control system; • The electronic engine control system; • The electronic throttle control system; or • The electronic automatic transmission control system.

5

When trouble arises





5-2. Steps to take in an emergency

Warning light	Warning light/Details
	<p>SRS warning light Malfunction in:</p> <ul style="list-style-type: none"> • The SRS airbag system; • The front passenger occupant classification system; or • The seat belt pretensioner system.
<p>ABS (U.S.A.)</p>  <p>(Canada)</p>	<p>ABS warning light Malfunction in:</p> <ul style="list-style-type: none"> • The ABS; or • The brake assist system.
	<p>Slip indicator light Malfunction in the Enhanced VSC or TRAC system.</p>
 <p>(if equipped)</p>	<p>Automatic headlight leveling system warning light Malfunction in the automatic headlight leveling system.</p>
	<p>Electric power steering system warning light Malfunction in the EPS (Electric Power Steering).</p>





5-2. Steps to take in an emergency

Follow the correction procedures.

After taking the specified steps to correct the suspected problem, check that the warning light turns off.

Warning light	Warning light/Details	Correction procedure
	Open door warning light (warning buzzer)*1 A door is not fully closed.	Check that all doors are closed.
	Driver's seat belt reminder light (warning buzzer)*2 Warns the driver to fasten his/her seat belt.	Fasten the seat belt.
 (On the center display)	Front passenger's seat belt reminder light (warning buzzer)*2 Warns the front passenger to fasten his/her seat belt.	Fasten the seat belt.
	Tire pressure warning light	
	When the light comes on: Low tire inflation pressure.	Adjust the tire inflation pressure.
	When the light comes on after blinking for 1 minute: Malfunction in the tire pressure warning system.	Have the system checked by your Toyota dealer.

5-2. Steps to take in an emergency

Warning light	Warning light/Details	Correction procedure
	Low fuel level warning light Indicates that remaining fuel is about 4.0 gal. (15.0 L, 3.3 Imp. gal.) or less	Refuel the vehicle.
 (if equipped)	Master warning light A buzzer sounds and the warning light comes on and flashes to indicate that the master warning system has detected a malfunction.	Take appropriate action in accordance with the message displayed on the multi-information display.
 (if equipped)	Low windshield washer fluid level warning light Indicates that the windshield washer fluid level is too low.	Add washer fluid.
 (AWD models)	Active Torque Control 4WD system warning light	
	When the light blinks: The system has been overloaded and front-wheel drive has been automatically engaged.	Drop your speed or stop the vehicle until the light stops blinking. (Do not stop the engine.)
	When the light comes on: Malfunction in the Active Torque Control 4WD system.	Have the system checked by your Toyota dealer.

5-2. Steps to take in an emergency

Warning light	Warning light/Details	Correction procedure
	Engine oil replacement reminder light	
	Illuminates for about 3 seconds and then flashes for about 15 seconds: Engine oil is scheduled to be changed.	Check and the engine oil, and change if necessary.
	Comes on and remains: Engine oil should be changed.	Check and change the engine oil.

*1: Open door warning buzzer:

The open door warning buzzer sounds to alert one or more of the doors is not fully closed (with the vehicle having reached a speed of 3 mph [5 km/h]).



*2: Driver's and front passenger's seat belt reminder buzzer:

The driver's and front passenger's seat belts reminder sounds to alert the driver and front passenger that his/her seat belt is not fastened. The buzzer sounds intermittently for 10 seconds after the vehicle had reached a speed of at least 12 mph (20 km/h). Then, if the seat belt is still unfastened, the buzzer will sound in a different tone for 20 more seconds.



5-2. Steps to take in an emergency

Follow the correction procedures. (smart key system)

After taking the specified steps to correct the suspected problem, check that the warning light turns off.

Interior buzzer	Exterior buzzer	Warning light	Warning light/Details	Correction procedure
Once	—	 (Comes on for 8 seconds.)	Smart key system warning light Indicates that the electronic key is not present when attempting to start the engine.	Confirm the location of the electronic key*.
Once	3 times		Smart key system warning light Indicates that a door other than the driver's door has been opened or closed with the "ENGINE START STOP" switch in any mode other than off and the electronic key outside of the detection area.	Confirm the location of the electronic key.

5-2. Steps to take in an emergency

Interior buzzer	Exterior buzzer	Warning light	Warning light/Details	Correction procedure
Once	3 times		Smart key system warning light Indicates that the driver's door has been opened or closed with the shift lever in "P", the "ENGINE START STOP" switch in any mode other than off and the electronic key outside of the detection area.	Turn the "ENGINE START STOP" switch off or confirm the location of the electronic key.
Continuous	Continuous		Smart key system warning light Indicates that the driver's door has been opened or closed with the shift lever not in "P", the "ENGINE START STOP" switch in any mode other than off and the electronic key outside of the detection area.	<ul style="list-style-type: none"> • Shift the shift lever to "P". • Confirm the location of the electronic key.

*: If the engine does not start when the electronic key is inside the vehicle, the electronic key battery may be depleted or there may be difficulties receiving the signal from the key. (→P. 593)

5
When trouble arises

5-2. Steps to take in an emergency

n **If the malfunction indicator lamp comes on while driving**

First check the following:

- l Is the fuel empty?
If it is, fill the fuel tank immediately.
- l Is the fuel tank cap loose?
If it is, tighten it securely.

The malfunction indicator lamp will go off after taking several driving trips. If the malfunction indicator lamp does not go off even after several trips, contact your Toyota dealer as soon as possible.

n **Key reminder buzzer (vehicles without smart key system)**

The buzzer indicates that the key has not been removed with the engine off and the driver's door opened.

n **Open moon roof warning buzzer**

The buzzer indicates that the moon roof is not fully closed with the engine off and the driver's door opened.

n **Front passenger detection sensor and passenger seat belt reminder**

- l If luggage is placed on the front passenger seat, the front passenger detection sensor may cause the warning light to flash, even if a passenger is not sitting in the seat.
- l If a cushion is placed on the seat, the sensor may not detect a passenger, and the warning light may not operate properly.

5-2. Steps to take in an emergency

n **SRS warning light**

This warning light system monitors the following:

- l The airbag sensor assembly
- l Front airbag sensors
- l The curtain shield airbag sensors
- l The side and curtain shield airbag sensors
- l The seat belt buckle switches
- l The driver's seat position sensor
- l The inflators
- l The interconnecting wiring and power sources
- l The front passenger occupant classification ECU
- l "AIR BAG ON" and "AIR BAG OFF" indicator lights
- l The seat belt pretensioners

n **Engine oil replacement reminder light (U.S.A. only)**

The engine oil replacement reminder light will come on and flash at approximately 4500 miles (7200 km) after an oil change. When the distance driven after an oil change exceeds approximately 5000 miles (8000 km), the light will come on and remain on.

5

When trouble arises

569

5-2. Steps to take in an emergency

n **Changing the engine oil (U.S.A. only)**

Make sure to reset the oil change system. (→P. 495)

n **The tire pressure warning light may come on due to natural causes**

The tire pressure warning light may come on due to natural causes such as natural air leaks or tire inflation pressure changes caused by temperature. In this case, adjusting the tire inflation pressure will turn off the warning light (after a few minutes).

n **When a tire is replaced with a spare tire**

The compact spare tire is not equipped with the tire pressure warning valve and transmitter. If a tire goes flat, the tire pressure warning light will not turn off even though the flat tire is replaced with the spare tire. Replace the spare tire with the repaired tire and adjust the proper tire inflation pressure. The tire pressure warning light will turn off after a few minutes.

5-2. Steps to take in an emergency

n If the tire pressure warning system is inoperative

The tire pressure warning system will be disabled in the following conditions:

(When the condition becomes normal, the system will work properly.)

- 1 If tires not equipped with tire pressure warning valves and transmitters are used.
- 1 If the ID code on the tire pressure warning valves and transmitters is not registered in the tire pressure warning computer.
- 1 If the tire inflation pressure is 73 psi (500 kPa, 5.1 kgf/cm² or bar) or higher.

The tire pressure warning system may be disabled in the following conditions:

(When the condition becomes normal, the system will work properly.)

- 1 If electronic devices or facilities using similar radio wave frequencies are nearby.
- 1 If a radio set at similar frequencies is in use in the vehicle.
- 1 If a window tint that affects the radio wave signals is installed.
- 1 If there is a lot of snow or ice on the vehicle, in particular around the wheels or wheel housings.
- 1 If non-genuine Toyota wheels are used. (Even if you use Toyota wheels, the tire pressure warning system may not work properly with some types of tires.)
- 1 If tire chains are used.

5-2. Steps to take in an emergency

n If the tire pressure warning light comes on after blinking for 1 minute frequently

▶ Vehicles with smart key system

If the tire pressure warning light comes on after blinking 1 minute frequently when the "ENGINE START STOP" switch is turned to IGNITION ON mode, have it checked by your Toyota dealer.

▶ Vehicles without smart key system

If the tire pressure warning light comes on after blinking 1 minute frequently when the engine switch is turned to the "ON" position, have it checked by your Toyota dealer.

⚠ CAUTION

n If the tire pressure warning light comes on

Be sure to observe the following precautions. Failure to do so could cause loss of vehicle control and result in death or serious injury.

- I** Stop your vehicle in a safe place as soon as possible. Adjust the tire inflation pressure immediately.
- I** If the tire pressure warning light comes on even after tire inflation pressure adjustment, it is probable that you have a flat tire. Check the tires. If the tire is flat, change to the spare tire and have the flat tire repaired by the nearest Toyota dealer.
- I** Avoid abrupt maneuvering and braking. If the vehicle tires deteriorate, you could lose control of the steering wheel or the brakes.

5-2. Steps to take in an emergency

⚠ CAUTION**n If a blowout or sudden air loss should occur**

The tire pressure warning system may not activate immediately.

n Maintenance of the tires

Each tire, including the spare (if provided), should be checked monthly when cold and inflated to the inflation pressure recommended by the vehicle manufacturer on the vehicle placard or tire inflation pressure label (tire and load information label). (If your vehicle has tires of a different size than the size indicated on the vehicle placard or tire inflation pressure label [tire and load information label], you should determine the proper tire inflation pressure for those tires.)

As an added safety feature, your vehicle has been equipped with a tire pressure monitoring system (TPMS-tire pressure warning system) that illuminates a low tire pressure telltale (tire pressure warning light) when one or more of your tires is significantly under-inflated. Accordingly, when the low tire pressure telltale (tire pressure warning light) illuminates, you should stop and check your tires as soon as possible, and inflate them to the proper pressure. Driving on a significantly under-inflated tire causes the tire to overheat and can lead to tire failure. Under-inflation also reduces fuel efficiency and tire tread life, and may affect the vehicle's handling and stopping ability.

Please note that the TPMS (tire pressure warning system) is not a substitute for proper tire maintenance, and it is the driver's responsibility to maintain correct tire pressure, even if under-inflation has not reached the level to trigger illumination of the TPMS low tire pressure telltale (tire pressure warning light).

5

When trouble arises

5-2. Steps to take in an emergency

CAUTION

Your vehicle has also been equipped with a TPMS (tire pressure warning system) malfunction indicator to indicate when the system is not operating properly. The TPMS (tire pressure warning system) malfunction indicator is combined with the low tire pressure telltale (tire pressure warning light). When the system detects a malfunction, the telltale will flash for approximately one minute and then remain continuously illuminated. This sequence will continue upon subsequent vehicle start-ups as long as the malfunction exists. When the malfunction indicator is illuminated, the system may not be able to detect or signal low tire pressure as intended.

TPMS (tire pressure warning system) malfunctions may occur for a variety of reasons, including the installation of replacement or alternate tires or wheels on the vehicle that prevent the TPMS (tire pressure warning system) from functioning properly. Always check the TPMS (tire pressure warning system) malfunction telltale after replacing one or more tires or wheels on your vehicle to ensure that the replacement or alternate tires and wheels allow the TPMS (tire pressure warning system) to continue to function properly.

NOTICE

n Precaution when installing a different tire

When a tire of a different specification or maker is installed, the tire pressure warning system may not operate properly.

5-2. Steps to take in an emergency If a warning message is displayed*

The multi-information display shows warnings of system malfunctions or incorrectly performed operations. When a message is shown, perform corrections as indicated in the message.

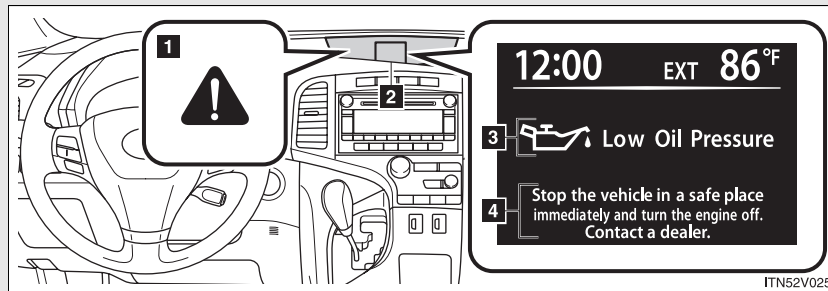

1 Master warning light

The master warning light comes on or flashes when a message is being shown on the multi-information display.

2 Multi-information display

3 Warning message

4 Correction procedure

n Warning buzzer

A buzzer may sound when a warning message is shown on the multi-information display.

n If the warning message is shown again after its correction procedure has been performed

Contact your Toyota dealer as soon as possible.

5

When trouble arises

*: If equipped

5-2. Steps to take in an emergency If you have a flat tire

Remove the flat tire and replace it with the spare provided.

n Before jacking up the vehicle

- 1 Stop the vehicle on a hard, flat surface.
- 1 Set the parking brake.
- 1 Shift the shift lever to "P".
- 1 Stop the engine.
- 1 Turn on the emergency flashers.

n Location of the spare tire, jack and tools

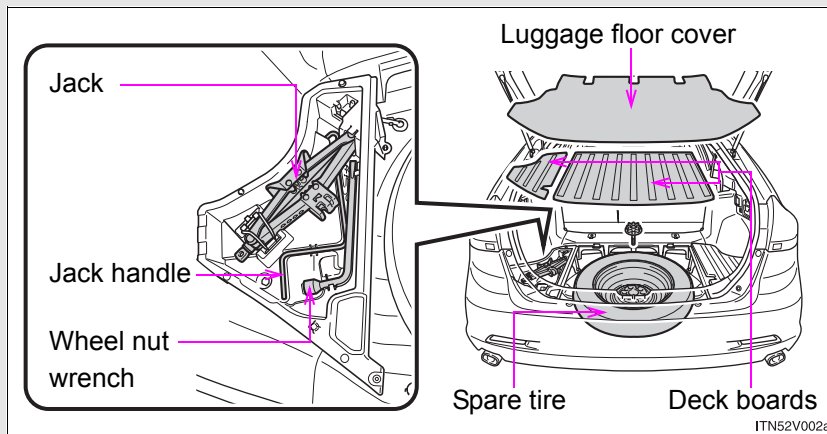

5-2. Steps to take in an emergency

n Compact spare tire

The compact spare tire saves space in your luggage compartment, and its lighter weight helps to enhance fuel economy and permits easier installation in case of a flat tire.

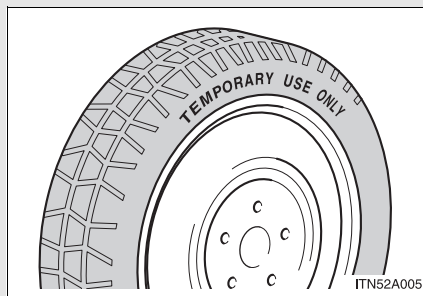

The compact spare tire is designed for temporary emergency use only.

Taking out the jack

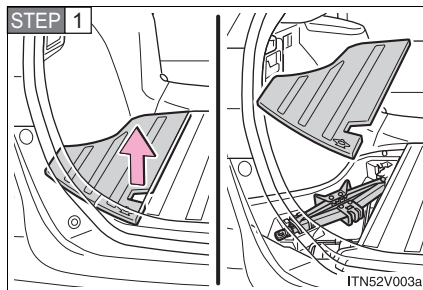

Remove the left side deck board.

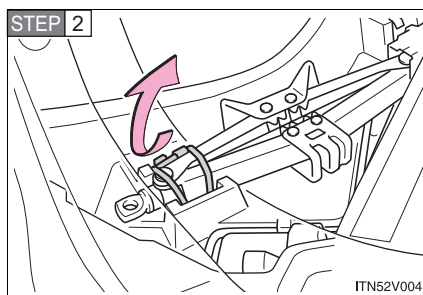

Unlock the tightening strap.

After storing the jack, make sure it is securely held by the tightening strap.

5

When trouble arises

5-2. Steps to take in an emergency

Taking out the spare tire

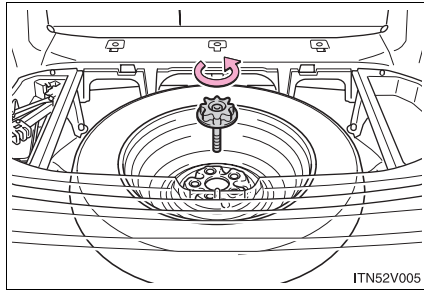

Loosen the center fastener that secures the spare tire.

Replacing a flat tire

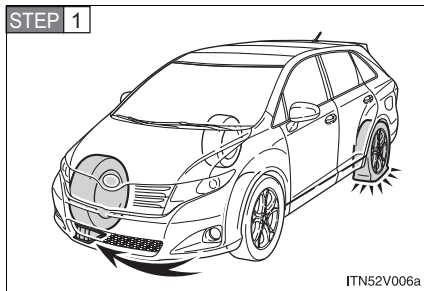

Chock the tires.

	Flat tire	Wheel chock positions
Front	Left-hand side	Behind the rear right-hand side tire
	Right-hand side	Behind the rear left-hand side tire
Rear	Left-hand side	In front of the front right-hand side tire
	Right-hand side	In front of the front left-hand side tire

5-2. Steps to take in an emergency

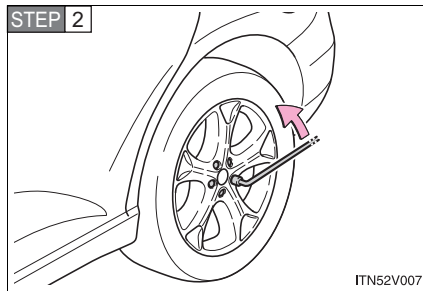

Slightly loosen the wheel nuts (one turn).

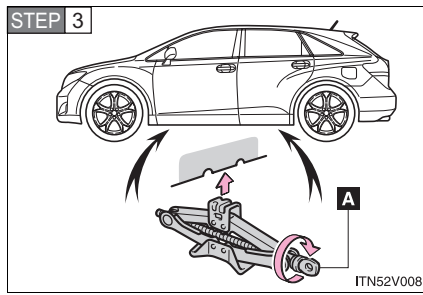

Turn the tire jack portion "A" by hand until the notch of the jack is in contact with the jack point.

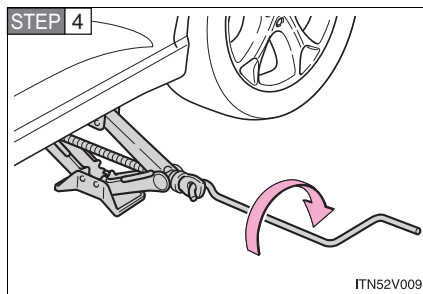

Raise the vehicle until the tire is slightly raised off the ground.

5

When trouble arises

5-2. Steps to take in an emergency

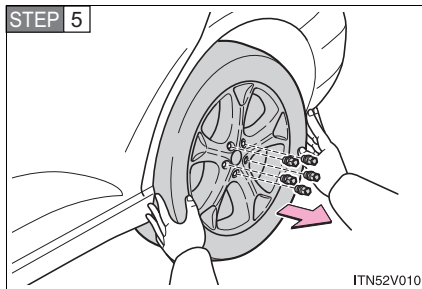

Remove all the wheel nuts and the tire.

When resting the tire on the ground, place the tire so that the wheel design faces up to avoid scratching the wheel surface.

Installing the spare tire

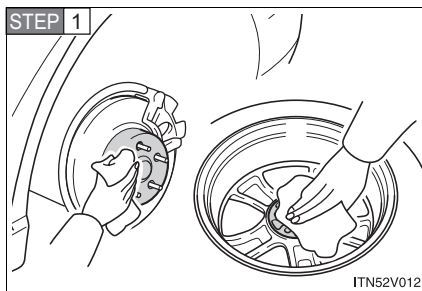

Remove any dirt or foreign matter from the wheel contact surface.

If foreign matter is on the wheel contact surface, the wheel nuts may loosen while the vehicle is in motion, and the tire may come off the vehicle.

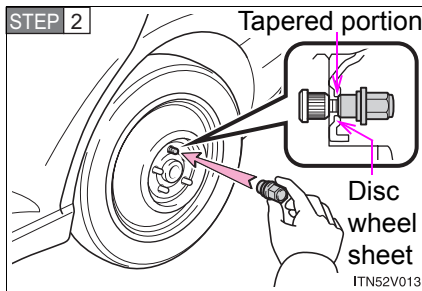

Install the spare tire and loosely tighten each nut by hand to approximately the same amount.

Tighten the wheel nuts until the tapered portion comes into loose contact with the disc wheel sheet.

5-2. Steps to take in an emergency

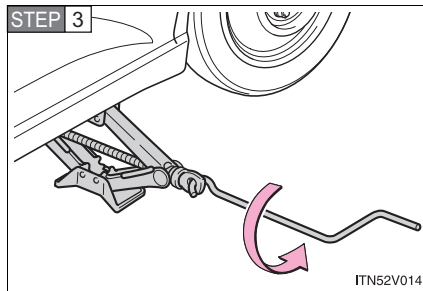

Lower the vehicle.

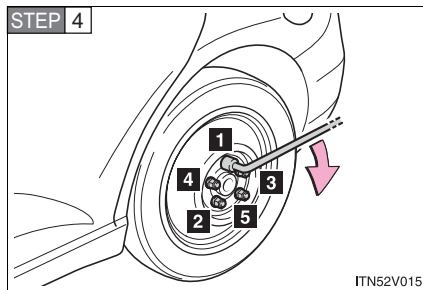

Firmly tighten each nut two or three times in the order shown in the illustration.

Tightening torque:
76 ft•lbf (103 N•m, 10.5 kgf•m)

STEP 5 Stow the flat tire, tire jack and all tools.

5

When trouble arises

5-2. Steps to take in an emergency

n **The compact spare tire**

- l The compact spare tire is identified by the label “TEMPORARY USE ONLY” on the tire sidewall.
Use the compact spare tire temporarily only in an emergency.
- l Make sure to check the tire inflation pressure of the compact spare tire. (→P. 620)

n **When using the compact spare tire**

As the spare tire is not equipped with the tire pressure warning valve and transmitter, low inflation pressure of the spare tire will not be warned. Also, if you replace the compact spare tire after the tire pressure warning light comes on, the light remains on.

n **If you have a flat front tire on a road covered with snow or ice**

Install the compact spare tire on the rear of the vehicle. Perform the following steps and fit tire chains to the front tires.

- STEP 1** Replace a rear tire with the compact spare tire.
- STEP 2** Replace the flat front tire with the tire removed from the rear of the vehicle.
- STEP 3** Fit tire chains to the front tires.

5-2. Steps to take in an emergency

CAUTION

n Using the tire jack

Improper use of the tire jack may lead to death or serious injuries due to the vehicle suddenly falling off the jack.

- I** Do not use the tire jack for any purpose other than replacing tires or installing and removing tire chains.
- I** Only use the tire jack that comes with this vehicle for replacing a flat tire.
Do not use it on other vehicles, and do not use other tire jacks for replacing tires on this vehicle.
- I** Always check that the tire jack is securely set to the jack point.
- I** Do not raise the vehicle while someone is in it.
- I** When raising the vehicle, do not put an object on or under the jack.
- I** Do not raise the vehicle to a height greater than that required to replace the tire.
- I** Use a jack stand if it is necessary to get under the vehicle.
- I** Do not put any part of your body under the vehicle supported by a jack.
- I** Do not start or run the engine while your vehicle is supported by the jack.

Take particular care when lowering the vehicle to ensure that no one working on or near the vehicle may be injured.

5

When trouble arises

5-2. Steps to take in an emergency

CAUTION

n Replacing a flat tire

Observe the following precautions to reduce the risk of death or serious injury.

- I** Have the wheel nuts tightened with a torque wrench to 76 ft•lbf (103 N•m, 10.5 kgf•m) as soon as possible after changing wheels. Failure to follow these precautions could cause the nuts to loosen and the wheels may fall off, which could lead to an accident causing death or serious injury.
- I** Do not attach a heavily damaged wheel ornament, as it may fly off the wheel while the vehicle is moving.

n When installing the wheel nuts

Be sure to install the wheel nuts with the tapered end facing inward.
(→P. 518)

5-2. Steps to take in an emergency

⚠ CAUTION**n When using the compact spare tire**

- ! Remember that your compact spare tire is specifically designed for use with your vehicle. Do not use your compact spare tire on another vehicle.
- ! Do not use two compact spare tires simultaneously.
- ! Replace the compact spare tire with a standard tire as soon as possible.
- ! Avoid sudden acceleration, deceleration and braking, as well as sharp cornering.

n Speed limit when using the compact spare tire

Do not drive at speeds in excess of 50 mph (80 km/h) when a compact spare tire is installed on the vehicle.

The compact spare tire is not designed for driving at high speeds. Failing to observe this precaution may lead to an accident causing death or serious injury.

n When the compact spare tire is attached

The vehicle speed may not be correctly detected, and the following systems may not operate correctly:

- ! ABS & Brake assist
- ! Enhanced VSC
- ! TRAC
- ! Cruise control system
- ! Navigation system (if equipped)

Also, not only can the AWD system not be utilized fully, it may actually negatively effect the drive-train components (AWD models only).

5

When trouble arises

5-2. Steps to take in an emergency

NOTICE

n Do not drive the vehicle with a flat tire

Do not continue driving with a flat tire.
Driving even a short distance with a flat tire can damage the tire and the wheel beyond repair.

n Be careful when driving over bumps with the compact spare tire installed on the vehicle

The vehicle becomes lower when driving with the compact spare tire compared to when driving with standard tires. Be careful when driving over uneven road surfaces.

n Driving with tire chains and the compact spare tire

Do not fit tire chains to the compact spare tire.
Tire chains may damage the vehicle body and adversely affect driving performance.

n When replacing the tires

- l** When removing or fitting the wheels, tires or the tire pressure warning valve and transmitter, contact your Toyota dealer as the tire pressure warning valve and transmitter may be damaged if not handled correctly.
- l** Replace the grommets for the tire pressure warning valves and transmitters as well.

n To avoid damage to the tire pressure warning valves and transmitters

When a tire is repaired with liquid sealants, the tire pressure warning valve and transmitter may not operate properly. If a liquid sealant is used, contact your Toyota dealer or other qualified service shop as soon as possible. Make sure to replace the tire pressure warning valve and transmitter when replacing the tire (→P. 507)

5-2. Steps to take in an emergency If the engine will not start

If the engine still does not start after following the correct starting procedure (→P. 159, 163) or releasing the steering lock (→P. 161, 164), confirm the following points.

n The engine will not start even if you are carrying the correct key.

One of the following may be the cause of the problem.

- 1 There may not be sufficient fuel in the vehicle's tank.
Refuel the vehicle.
- 1 The engine may be flooded.
Try to restart the engine once more following correct starting procedures. (→P. 159)
- 1 There may be a malfunction in the engine immobilizer system.
(→P. 97)

n The starter motor turn over slowly, the interior lights and headlights are dim, or the horn does not sound or sounds at a low volume.

One of the following may be the cause of the problem.

- 1 The battery may be discharged. (→P. 595)
- 1 The battery terminal connections may be loose or corroded.

5-2. Steps to take in an emergency

n The starter motor does not turn over (vehicles with smart key system).

The engine starting system may be malfunctioning due to an electrical problem such as an open circuit or a blown fuse. However, an interim measure is available to start the engine.
(→P. 589)

n The starter motor does not turn over, the interior lights and headlights do not turn on, or the horn does not sound.

One of the following may be the cause of the problem.

- 1 One or both of the battery terminals may be disconnected.
- 1 The battery may be discharged. (→P. 595)
- 1 There may be a malfunction in the steering lock system (vehicles with smart key system).

Contact your Toyota dealer if the problem cannot be repaired, or if repair procedures are unknown.

5-2. Steps to take in an emergency

Emergency start function (vehicles with smart key system)

When the engine does not start, the following steps can be used as an interim measure to start the engine if the “ENGINE START STOP” switch is functioning normally.

STEP 1 Set the parking brake.

STEP 2 Shift the shift lever to “P”.

STEP 3 Set the “ENGINE START STOP” switch to ACCESSORY mode.

STEP 4 Press and hold the “ENGINE START STOP” switch for about 15 seconds while depressing the brake pedal firmly.

Even if the engine can be started using the above steps, the system may be malfunctioning. Have the vehicle checked by your Toyota dealer.

5-2. Steps to take in an emergency If the shift lever cannot be shifted from “P”

If the shift lever cannot be shifted with your foot on the brake, there may be a problem with the shift lock system (a system to prevent accidental operation of the shift lever). Have the vehicle inspected by your Toyota dealer immediately.

The following steps may be used as an emergency measure to ensure that the shift lever can be shifted.

STEP 1 Set the parking brake.

STEP 2 Vehicles with smart key system: Turn the “ENGINE START STOP” switch to ACCESSORY mode.

Vehicles without smart key system: Turn the engine switch to the “ACC” position.

STEP 3 Depress the brake pedal.

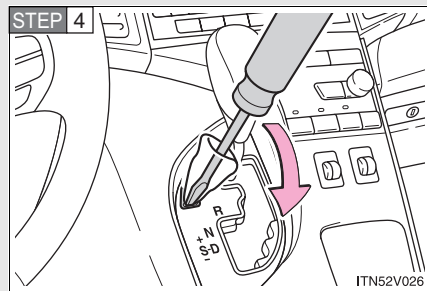

Pry the cover up with a flat-head screwdriver or equivalent.

To prevent damage to the cover, cover the tip of the screwdriver with a rag.

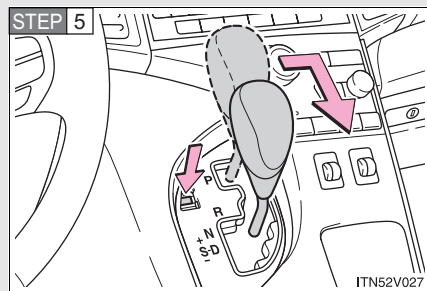

Press the shift lock override button.

The shift lever can be shifted while the button is pressed.

5-2. Steps to take in an emergency If you lose your keys

New genuine keys can be made by your Toyota dealer. Bring the other key and the key number stamped on the key number plate.

5

When trouble arises

591

5-2. Steps to take in an emergency

If the electronic key does not operate properly (vehicles with smart key system)

If communication between the electronic key and vehicle is interrupted (→P. 28) or the electronic key cannot be used because the battery is depleted, the smart key system and wireless remote control cannot be used. In such cases, the doors can be opened or the engine can be started by following the procedure below.

Locking and unlocking the doors and key linked functions

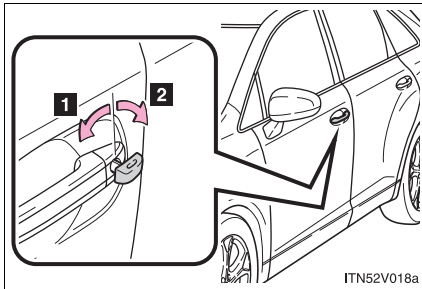

Using the mechanical key (→P. 27) in order to perform the following operations.

- 1** Locks all doors
- 2** Unlocks all doors

Turning the key rearward unlocks the driver's door. Turning the key once again within 3 seconds unlocks the other doors.

5-2. Steps to take in an emergency

Changing “ENGINE START STOP” switch modes and starting the engine

STEP 1 Shift the shift lever to “P” and apply the brakes.

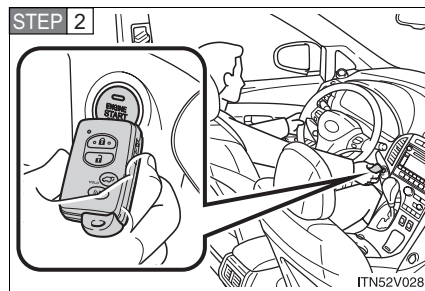

Touch the Toyota emblem side of the electronic key to the “ENGINE START STOP” switch.

An alarm will sound to indicate that the start function cannot detect the electronic key that is touched to the “ENGINE START STOP” switch if any of the doors is opened and closed while the key is touched to the switch.

STEP 3 To change “ENGINE START STOP” switch modes: Within 10 seconds of the buzzer sounding, release the brake pedal and press the “ENGINE START STOP” switch. Modes can be changed each time the switch is pressed. (→P. 160)
To start the engine: Press the “ENGINE START STOP” switch within 10 seconds after the buzzer sounds, keeping the brake pedal depressed.

In the event that the “ENGINE START STOP” switch cannot be operated, contact your Toyota dealer.

5

When trouble arises

5-2. Steps to take in an emergency

n **Stopping the engine**

Shift the shift lever to “P” and press the “ENGINE START STOP” switch as you normally do when stopping the engine.

n **Replacing the key battery**

As this above procedure is a temporary measure, it is recommended that the electronic key battery be replaced immediately when the battery depletes. (→P. 523)

n **Alarm**

Using the mechanical key to lock the doors will not set the alarm system. If a door is unlocked using the mechanical key when the alarm system is set, the alarm may be triggered. (→P. 100)

5-2. Steps to take in an emergency If the battery is discharged

The following procedures may be used to start the engine if the battery is discharged.

You can call your Toyota dealer or qualified repair shop.

If you have a set of jumper (or booster) cables and a second vehicle with a 12 volt battery, you can jump start your Toyota following the steps below.

STEP 1 Connecting the jumper cables.

▶ 2GR-FE engine

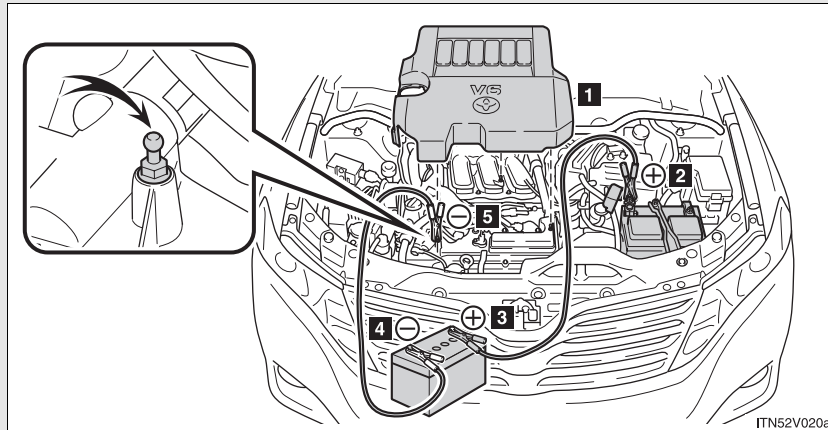

- 1** Remove the engine cover.
- 2** Positive (+) battery terminal on your vehicle
- 3** Positive (+) battery terminal on the second vehicle
- 4** Negative (-) battery terminal on the second vehicle
- 5** Connect the jumper cable to ground on your vehicles as shown in the illustration.

5

When trouble arises

5-2. Steps to take in an emergency

► 1AR-FE engine

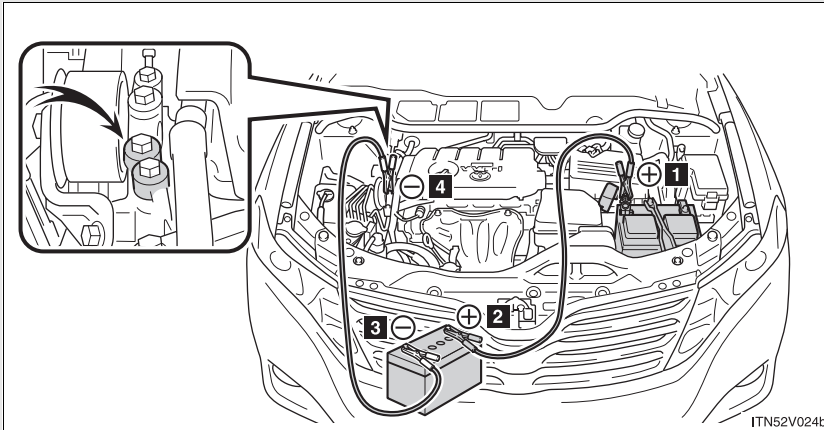

- 1** Positive (+) battery terminal on your vehicle
- 2** Positive (+) battery terminal on the second vehicle
- 3** Negative (-) battery terminal on the second vehicle
- 4** Connect the jumper cable to ground on your vehicles as shown in the illustration.

5-2. Steps to take in an emergency

- STEP 2** Start the engine of the second vehicle. Increase the engine speed slightly and maintain at that level for approximately 5 minutes to recharge the battery of your vehicle.
- STEP 3** Vehicles with smart key system: Open and close any of the doors with the “ENGINE START STOP” switch off.
- STEP 4** Maintain the engine speed of the second vehicle and turn the “ENGINE START STOP” switch to IGNITION ON mode (vehicles with smart key system) or turn the engine switch to the “ON” position (vehicles without smart key system), then start your vehicle’s engine.
- STEP 5** Once the vehicle’s engine has started, remove the jumper cables in the exact reverse order in which they were connected.

Once the engine starts, have the vehicle checked at your Toyota dealer as soon as possible.

5-2. Steps to take in an emergency

n **Starting the engine when the battery is discharged**

The engine cannot be started by push-starting.

n **Avoiding a discharged battery**

- l Turn off the headlights and the audio system while the engine is turned off.
- l Turn off any unnecessary electrical components when the vehicle is running at a low speed for an extended period, such as in heavy traffic, etc.

n **When the battery is removed or discharged**

The power back door must be initialized. (→P. 57)

CAUTION

n **Avoiding battery fires or explosions**

Observe the following precautions to prevent accidentally igniting the flammable gas that may be emitted from the battery.

- l Make sure the jumper cable is connected to the correct terminal and that it is not unintentionally in contact with any part other than the intended terminal.
- l Do not allow the jumper cables to come into contact with the “+” and “-” terminals.
- l Do not allow open flame or use matches, cigarette lighters or smoke near the battery.

5-2. Steps to take in an emergency

CAUTION

n Battery precautions

The battery contains poisonous and corrosive acidic electrolyte, while related parts contain lead and lead compounds. Observe the following precautions when handling the battery:

- I** When working with the battery, always wear safety glasses and take care not to allow any battery fluids (acid) to come into contact with skin, clothing or the vehicle body.
- I** Do not lean over the battery.
- I** If the battery fluid comes into contact with the skin or eyes, immediately wash the affected area with water and seek medical attention. Place a wet sponge or cloth over the affected area until medical attention can be received.
- I** Always wash your hands after handling the battery support, terminals, and other battery-related parts.
- I** Do not allow children near the battery.

NOTICE

n When handling jumper cables

Be careful that the jumper cables do not become tangled in the cooling fan or any of the belts when connecting or disconnecting them.

5

When trouble arises

5-2. Steps to take in an emergency If your vehicle overheats

If your engine overheats:

STEP 1 Stop the vehicle in a safe place and turn off the air conditioning system.

STEP 2 Check to see if steam is coming out from under the hood.

If you see steam:

Stop the engine. Carefully lift the hood after the steam subsides and then restart the engine.

If you do not see steam:

Leave the engine running and carefully lift the hood.

STEP 3 Check to see if the cooling fan is operating.

If the fan is operating:

Wait until the engine coolant temperature gauge begins to fall and then stop the engine.

If the fan is not operating:

Stop the engine immediately and call your local Toyota dealer.

5-2. Steps to take in an emergency

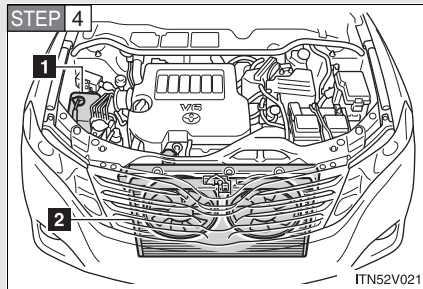

After the engine has cooled down sufficiently, check the engine coolant level and inspect the radiator core (radiator) for any leaks.

- 1 Engine coolant reservoir
- 2 Radiator

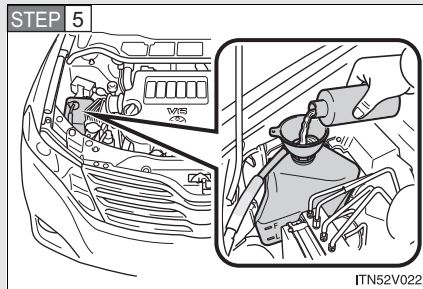

Add engine coolant if required.

Water can be used in an emergency measure if engine coolant is unavailable. (→P. 615)

Have the vehicle checked at the nearest Toyota dealer as soon as possible.

n Overheating

In the following situations, your vehicle may be overheating.

- 1 The engine coolant temperature gauge enters the red zone or a loss of power is experienced.
- 1 Steam is coming from under the hood.

5

When trouble arises

5-2. Steps to take in an emergency

CAUTION

n To prevent an accident or injury when inspecting under the hood of your vehicle

- I** If steam is seen coming from under the hood, do not open the hood until the steam has subsided. The engine compartment may be very hot, causing serious injury such as burns.
- I** Keep hands and clothing away from the fan and engine drive belt while the engine is running.
- I** Do not loosen the radiator cap while the engine and radiator are hot. Serious injury, such as burns, may result from hot coolant and steam released under pressure.

NOTICE

n When adding engine coolant

Wait until the engine has cooled down before adding engine coolant. When adding coolant, do so slowly. Adding cool coolant to a hot engine too quickly can cause damage to the engine.

5-2. Steps to take in an emergency If the vehicle becomes stuck

Carry out the following procedures if the tires spin or the vehicle becomes stuck in mud, dirt, or snow.

- STEP 1** Stop the engine. Set the parking brake and shift the shift lever in "P".
- STEP 2** Remove the mud, snow or sand from around the stuck tire.
- STEP 3** Place wood, stones or some other material to help provide traction under the tires.
- STEP 4** Restart the engine.
- STEP 5** Turn off Enhanced VSC. (→ P. 226)
- STEP 6** Shift the shift lever to "D" or "R" position and carefully apply the accelerator to free the vehicle.

CAUTION

n When attempting to free a stuck vehicle

If you choose to rock the vehicle back and forth to free it, make sure the surrounding area is clear, to avoid striking other vehicles, objects or persons. The vehicle may also lunge forward or lunge back suddenly as it becomes free. Use extreme caution.

n When shifting the shift lever

Be careful not to shift the shift lever with the accelerator pedal depressed. This may lead to unexpected rapid acceleration of the vehicle that may cause an accident and result in death or serious injury.

5

When trouble arises

5-2. Steps to take in an emergency

NOTICE

n To avoid damaging the transmission and other components

- l** Avoid spinning the wheels and do not rev the engine.
- l** If the vehicle remains stuck after trying these procedures, the vehicle may require towing to be freed.

5-2. Steps to take in an emergency If your vehicle has to be stopped in an emergency

Only in an emergency, such as if it becomes impossible to stop the vehicle in the normal way, stop the vehicle using the following procedure:

STEP 1 Steadily step on the brake pedal with both feet and firmly depress it.

Do not pump the brake pedal repeatedly as this will increase the effort required to slow the vehicle.

STEP 2 Shift the shift lever to N.

If the shift lever is shifted to N

STEP 3 After slowing down, stop the vehicle in a safe place by the road.

STEP 4 Stop the engine.

If the shift lever cannot be shifted to N

STEP 3 Keep depressing the brake pedal with both feet to reduce vehicle speed as much as possible.

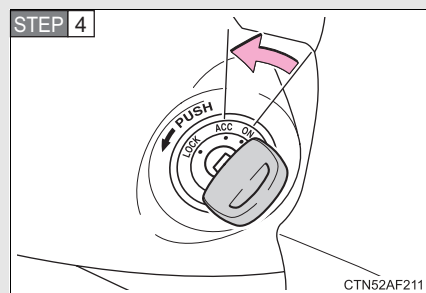

Vehicles without a smart key system: Stop the engine by turning the engine switch to the "ACC" position.

5-2. Steps to take in an emergency

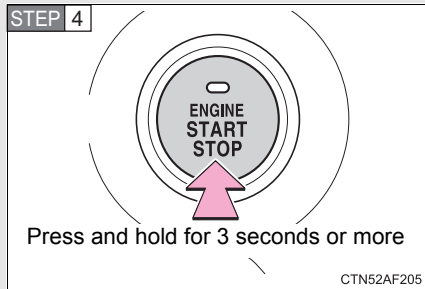

Vehicles with a smart key system: Stop the engine by pressing and holding the “ENGINE START STOP” switch for 3 consecutive seconds or more.

STEP 5 Stop the vehicle in a safe place by the road.

CAUTION

n If the engine has to be turned off while driving

- I** Power assist for the brakes and steering wheel will be lost, making the brake pedal harder to depress and the steering wheel heavier to turn. Decelerate as much as possible before turning off the engine.
- I** Vehicles without a smart key system: Never attempt to remove the key, as doing so will lock the steering wheel.

Vehicle specifications

6

6-1. Specifications

Maintenance data (fuel, oil level, etc.)	608
Fuel information	622
Tire information	625

6-2. Customization

Customizable features	640
-----------------------------	-----

6-3. Initialization

Items to initialize	647
---------------------------	-----

6-1. Specifications

Maintenance data (fuel, oil level, etc.)

Dimensions and weights

Overall length		189.0 in. (4800 mm)
Overall width		75.0 in. (1905 mm)
Overall height ^{*1}		63.4 in. (1610 mm)
Wheelbase		109.3 in. (2775 mm)
Tread	Front	64.2 in. (1630 mm)
	Rear	64.4 in. (1635 mm) ^{*2} 64.2 in. (1630 mm) ^{*3}
Vehicle capacity weight (Occupants + luggage)		895 lb. (405 kg)
Towing capacity (Trailer weight + cargo weight)	With towing package	3500 lb. (1585 kg) ^{*4} 2500 lb. (1135 kg) ^{*5}
	Without towing package	1000 lb. (450 kg)

- *1. Unladen vehicle
- *2. 2WD models
- *3. AWD models
- *4. 2GR-FE engine
- *5. 1AR-FE engine

Vehicle identification

▮ Vehicle identification number

The vehicle identification number (VIN) is the legal identifier for your vehicle. This is the primary identification number for your Toyota. It is used in registering the ownership of your vehicle.

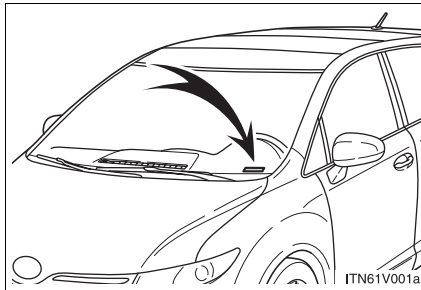

This number is stamped on the top left of the instrument panel.

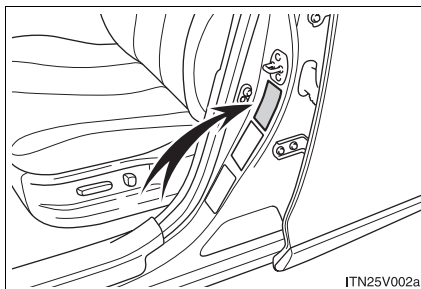

This number is also on the Certification Label.

6-1. Specifications

n Engine number

▶ 2GR-FE engine

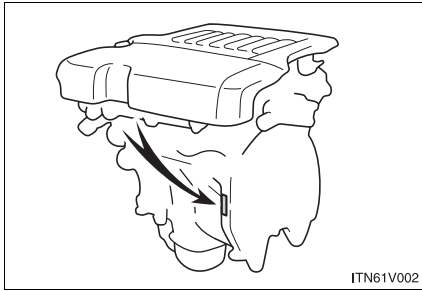

The engine number is stamped on the engine block as shown.

▶ 1AR-FE engine

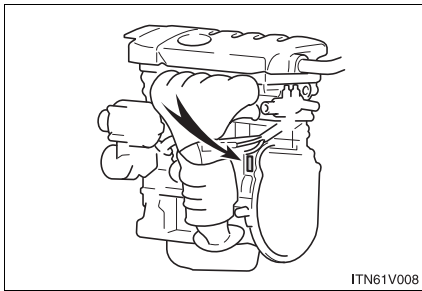

6-1. Specifications

Engine

Model	2GR-FE, 1AR-FE
Type	
▶ 2GR-FE engine	6-cylinder V type, 4-cycle, gasoline
▶ 1AR-FE engine	4-cylinder in line, 4-cycle, gasoline
Bore and stroke	
▶ 2GR-FE engine	3.70 × 3.27 in. (94.0 × 83.0 mm)
▶ 1AR-FE engine	3.54 × 4.13 in. (90.0 × 105.0 mm)
Displacement	
▶ 2GR-FE engine	210.9 cu.in. (3456 cm ³)
▶ 1AR-FE engine	163.1 cu.in. (2672 cm ³)
Valve clearance (engine cold)	Automatic adjustment
Drive belt tension	Automatic adjustment

Fuel

Fuel type	Unleaded gasoline only
Octane rating	87 (Research octane number 91) or higher
Fuel tank capacity (Reference)	17.7 gal. (67 L, 14.7 Imp.gal)

6-1. Specifications

Lubrication system

2GR-FE engine

Oil capacity
(Drain and refill —
reference)

With filter	6.4 qt. (6.1 L, 5.4 Imp.qt.)
Without filter	6.0 qt. (5.7 L, 5.0 Imp.qt.)

Engine oil selection

“Toyota Genuine Motor Oil” is used in your Toyota vehicle. Use Toyota approved “Toyota Genuine Motor Oil” or equivalent to satisfy the following grade and viscosity.

Oil grade: ILSAC multigrade engine oil

Recommended viscosity: SAE 5W-30

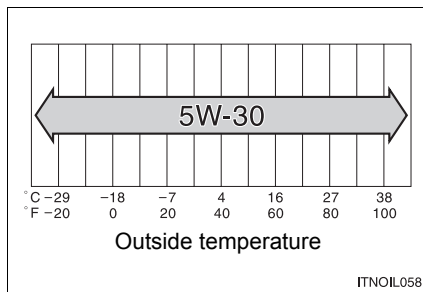

SAE 5W-30 is the best choice for good fuel economy and good starting in cold weather.

If SAE 5W-30 is not available, SAE 10W-30 oil may be used. However, it should be replaced with SAE 5W-30 at the next oil change.

The 5W portion of the oil viscosity rating indicates the characteristic of the oil which allows cold startability. Oils with a lower value before the W allow for easier starting of the engine in cold weather.

The 30 in 5W-30 indicates the oil viscosity when the oil is at its operating temperature. An oil with a higher viscosity may be better suited if the vehicle is operated at high speeds, or under extreme load conditions.

How to read oil container label:

The ILSAC (International Lubricant Standardization and Approval Committee) Certification Mark is added to some oil containers to help you select the oil you should use.



1AR-FE engine

Oil capacity	
Drain and refill (Reference)	
With filter	4.7 qt. (4.4 L, 3.9 Imp.qt.)
Without filter	4.2 qt. (4.0 L, 3.5 Imp.qt.)

n Engine oil selection

“Toyota Genuine Motor Oil” is used in your Toyota vehicle. Use Toyota approved “Toyota Genuine Motor Oil” or equivalent to satisfy the following grade and viscosity.

Oil grade: ILSAC multigrade engine oil

Recommended viscosity: SAE 5W-20 or 0W-20

6-1. Specifications

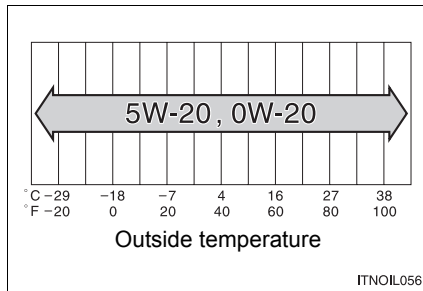

SAE 5W-20 or 0W-20 engine oil may be used. However, SAE 0W-20 is the best choice for good fuel economy and good starting in cold weather.

The 0W portion of the oil viscosity rating indicates the characteristic of the oil which allows cold startability. Oils with a lower value before the W allow for easier starting of the engine in cold weather.

The 20 in 0W-20 indicates the oil viscosity when the oil is at its operating temperature. An oil with a higher viscosity may be better suited if the vehicle is operated at high speeds, or under extreme load conditions.

How to read oil container label:

The ILSAC (International Lubricant Standardization and Approval Committee) Certification Mark is added to some oil containers to help you select the oil you should use.



6-1. Specifications

Cooling system

<p>Capacity</p> <p>▶ 2GR-FE engine</p> <p>▶ 1AR-FE engine</p>	<p>With towing package: 10.7 qt. (10.1 L, 8.9 Imp.qt.) Without towing package: 10.4 qt. (9.8 L, 8.6 Imp.qt.)</p> <p>7.3 qt. (6.9 L, 6.1 Imp.qt.)</p>
<p>Coolant type</p>	<p>Use either of the following:</p> <ul style="list-style-type: none"> • “Toyota Super Long Life Coolant” • Similar high-quality ethylene glycol-based non-silicate, non-amine, non-nitrite, and non-borate coolant with long-life hybrid organic acid technology <p>Do not use plain water alone.</p>

6-1. Specifications

Ignition system

Spark plug	
Make	DENSO
▶ 2GR-FE engine	FK20HR11
▶ 1AR-FE engine	SK16HR11
Gap	0.043 in. (1.1 mm)

 **NOTICE**

n Iridium-tipped spark plugs

Use only iridium-tipped spark plugs. Do not adjust gap when tuning engine.

Electrical system

Battery	
Open voltage at 68°F (20°C):	12.6 — 12.8 V Fully charged 12.2 — 12.4 V Half charged 11.8 — 12.0 V Discharged (Voltage is checked 20 minutes after the engine and all the lights are turned off.)
Charging rates	5 A max.

Rear differential (AWD models)

Oil capacity	0.52 qt. (0.50 L, 0.44 Imp.qt.)
Oil type	Hypoid gear oil API GL-5
Recommended oil viscosity	Above 0°F (-18°C): SAE 90 Below 0°F (-18°C): SAE 80W or SAE 80W-90

Automatic transaxle

Fluid capacity*	
▶ 2GR-FE engine	2WD models: 6.9 qt. (6.5 L, 5.7 Imp.qt.) AWD models: 7.1 qt. (6.7 L, 5.9 Imp.qt.)
▶ 1AR-FE engine	6.9 qt. (6.5 L, 5.7 Imp.qt.)
Fluid type	Toyota Genuine ATF WS

*: The fluid capacity is a reference quantity. If replacement is necessary, contact your Toyota dealer.

 NOTICE

n Automatic transaxle fluid type

Using transaxle fluid other than “Toyota Genuine ATF WS” may cause deterioration in shift quality, locking up of your transaxle accompanied by vibration, and ultimately damage the transaxle of your vehicle.

Transfer (AWD models)

Oil capacity	0.84 qt. (0.80 L, 0.70 Imp.qt.)
Oil type	Hypoid gear oil API GL-5
Recommended oil viscosity	Above 0°F (-18°C): SAE 90 Below 0°F (-18°C): SAE 80W or 80W-90

6-1. Specifications

Brakes

Pedal clearance ^{*1}	1.1 in. (28 mm) Min.
Pedal free play	0.04 — 0.12 in. (1.0 — 3.0 mm)
Brake pad wear limit	0.04 in. (1.0 mm)
Parking brake lining wear limit	0.04 in. (1.0 mm)
Parking brake adjustment ^{*2}	4 — 6 clicks
Fluid type	SAE J1703 or FMVSS No. 116 DOT 3

*1: Minimum pedal clearance when depressed with a force of 112 lbf (500 N, 51 kgf) while the engine is running.

*2: Parking brake pedal travel when depressed with a force of 67.4 lbf (300 N, 30.6 kgf).

Steering

Free play	Less than 1.2 in. (30 mm)
-----------	---------------------------

Tires and wheels

► Type A

Tire size	P245/50R20 102H
Tire inflation pressure (Recommended cold tire inflation pressure)	<p>Driving under normal conditions</p> <p>Front tires: 32 psi (220 kPa, 2.2 kgf/cm² or bar)</p> <p>Rear tires: 32 psi (220 kPa, 2.2 kgf/cm² or bar)</p> <p>Driving at high speeds above 99 mph (160 km/h) (in countries where such speeds are permitted by law)</p> <p>Add 3 psi (20 kPa, 0.2 kgf/cm² or bar) to the front tires and rear tires. Never exceed the maximum cold tire inflation pressure indicated on the tire sidewall.</p>
Wheel size	20 × 7 1/2 J
Wheel nut torque	76 ft•lbf (103 N•m, 10.5 kgf•m)

6-1. Specifications

► Type B

Tire size	P245/55R19 103S
Tire inflation pressure (Recommended cold tire inflation pressure)	<p>Driving under normal conditions</p> <p>Front tires: 32 psi (220 kPa, 2.2 kgf/cm² or bar)</p> <p>Rear tires: 32 psi (220 kPa, 2.2 kgf/cm² or bar)</p> <p>Driving at high speeds above 99 mph (160 km/h) (in countries where such speeds are permitted by law)</p> <p>Add 3 psi (20 kPa, 0.2 kgf/cm² or bar) to the front tires and rear tires. Never exceed the maximum cold tire inflation pressure indicated on the tire sidewall.</p>
Wheel size	19 × 7 1/2 J
Wheel nut torque	76 ft•lbf (103 N•m, 10.5 kgf•m)

► Spare tire

Tire size	T165/90D18 107M
Tire inflation pressure (Recommended cold tire inflation pressure)	60 psi (420 kPa, 4.2 kgf/cm ² or bar)
Wheel size	18 x 4T
Wheel nut torque	76 ft•lbf (103 N•m, 10.5 kgf•m)

Light bulbs

	Light Bulbs	Bulb No.	W	Type
Exterior	Headlights			
	Low beam (discharge bulbs*)	—	35	A
	Low beam (halogen bulbs*)	—	55	B
	High beam	9005	60	C
	Front turn signal/parking lights	3457 NAK	30/8	D
	Front side marker lights	168	5	E
	Front fog lights*	—	55	B
	Stop/tail and rear side marker lights	7443	21/5	E
	Tail lights	194	3.8	E
Rear turn signal lights	7440A	21	D	
Back-up lights	921	16	E	
License plate lights	W5W	5	E	
Interior	Front interior light	—	5	E
	Front personal lights	—	5	E
	Rear personal/interior lights	—	8	E
	Vanity lights	—	8	E
	Door courtesy lights	—	5	E
	Glove box light	74	1.2	E
	Luggage compartment light	—	5	F

A: D4S discharge bulbs
 B: H11 halogen bulbs
 C: HB3 halogen bulbs
 D: Wedge base bulbs (amber)

E: Wedge base bulbs (clear)
 F: Double end bulbs
 *: If equipped

6

Vehicle specifications

6-1. Specifications

Fuel information

Your vehicle must use only unleaded gasoline.

Select octane rating 87 (Research Octane Number 91) or higher. Use of unleaded gasoline with an octane rating lower than 87 may result in engine knocking. Persistent knocking can lead to engine damage.

At minimum, the gasoline you use should meet the specifications of ASTM D4814 in the U.S.A. and CGSB3.5-M93 in Canada.

n Fuel tank opening for unleaded gasoline

To help prevent incorrect fueling, your Toyota has a fuel tank opening that only accommodates the special nozzle on unleaded fuel pumps.

n If your engine knocks

l Consult your Toyota dealer.

l You may occasionally notice light knocking for a short time while accelerating or driving uphill. This is normal and there is no need for concern.

n Gasoline quality

In very few cases, driveability problems may be caused by the brand of gasoline you are using. If driveability problems persist, try changing the brand of gasoline. If this does not correct the problem, consult your Toyota dealer.

n Gasoline quality standards

- l Automotive manufacturers in the US, Europe and Japan have developed a specification for fuel quality called World-Wide Fuel Charter (WWFC) that is expected to be applied worldwide.
- l The WWFC consists of four categories that are based on required emission levels. In the US, category 4 has been adopted.
- l The WWFC improves air quality by lowering emissions in vehicle fleets, and customer satisfaction through better performance.

n Toyota recommends the use of gasoline containing detergent additives

- l Toyota recommends the use of gasoline that contains detergent additives to avoid build-up of engine deposits.
- l All gasoline sold in the US contains detergent additives to clean and/or keep clean intake systems.

n Toyota recommends the use of cleaner burning gasoline

Cleaner burning gasoline, including reformulated gasoline that contains oxygenates such as ethanol or MTBE (Methyl Tertiary Butyl Ether) is available in many areas.

Toyota recommends the use of cleaner burning gasoline and appropriately blended reformulated gasoline. These types of gasoline provide excellent vehicle performance, reduce vehicle emissions and improve air quality.

n Toyota does not recommend blended gasoline

- l Toyota allows the use of oxygenate blended gasoline where the oxygenate content is up to 10% ethanol or 15% MTBE.
- l If you use gasohol in your Toyota, be sure that it has an octane rating no lower than 87.
- l Toyota DOES NOT recommend the use of gasoline containing methanol.

6-1. Specifications

n Toyota does not recommend gasoline containing MMT

Some gasoline contains octane enhancing additive called MMT (Methylcyclopentadienyl Manganese Tricarbonyl).

Toyota DOES NOT recommend the use of gasoline that contains MMT. If fuel containing MMT is used, your emission control system may be adversely affected.

The malfunction indicator lamp on the instrument cluster may come on. If this happens, contact your Toyota dealer for service.

NOTICE

n Notice on fuel quality

I Do not use improper fuels. If improper fuels are used the engine will be damaged.

I Do not use leaded gasoline.
Leaded gasoline can cause damage to your vehicle's three-way catalytic converters causing the emission control system to malfunction.

I Do not use gasohol other than that stated here.
Other gasohol may cause fuel system damage or vehicle performance problems.

I Using unleaded gasoline with an octane number or rating lower than that stated here will cause persistent heavy knocking.
At worst, this will lead to engine damage.

n Fuel-related poor driveability

If after using a different type of fuel, poor driveability is encountered (poor hot starting, vaporization, engine knocking, etc.), discontinue the use of that type of fuel.

n When refueling with gasohol

Take care not to spill gasohol. It can damage your vehicle's paint.

6-1. Specifications

Tire information

Typical tire symbols

► Standard tire

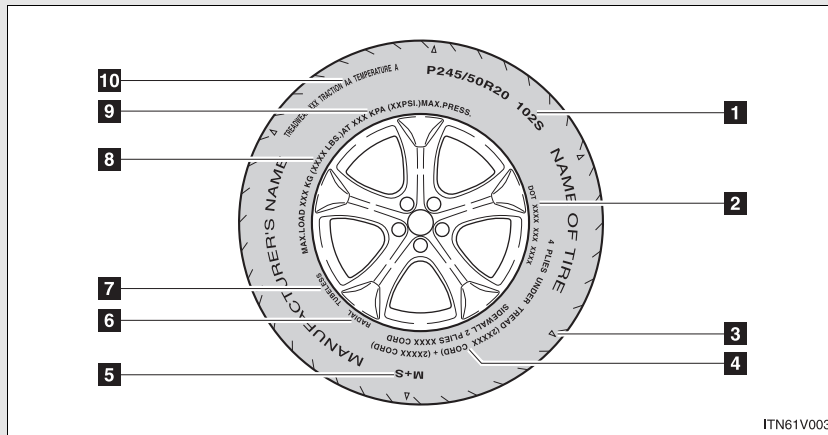

► Compact spare tire

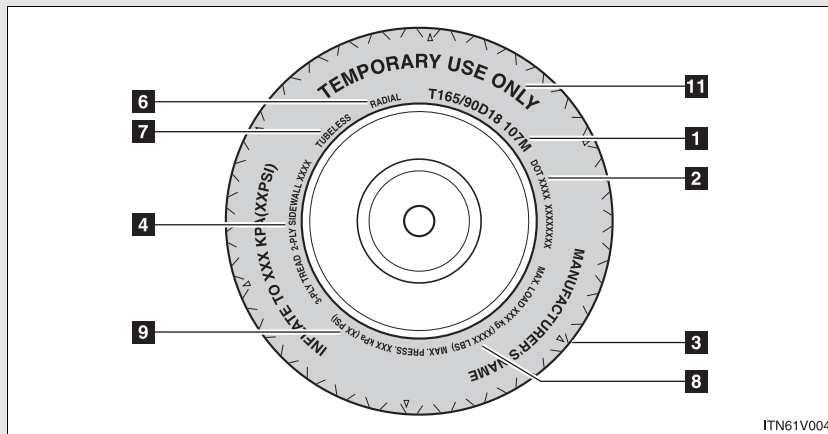

- 1** Tire size (→P. 628)
- 2** DOT and Tire Identification Number (TIN) (→P. 627)

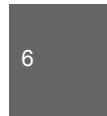

Vehicle specifications

6-1. Specifications

3 Location of treadwear indicators (→P. 506)

4 Tire ply composition and materials

Plies are layers of rubber-coated parallel cords. Cords are the strands which form the plies in a tire.

5 Summer tire or all season tire (→P. 509)

An all season tire has "M+S" on the sidewall. A tire not marked "M+S" is a summer tire.

6 Radial tires or bias-ply tires

A radial tire has RADIAL on the sidewall. A tire not marked RADIAL is a bias-ply tire.

7 TUBELESS or TUBE TYPE

A tubeless tire does not have a tube and air is directly filled in the tire. A tube type tire has a tube inside the tire and the tube maintains the air pressure.

8 Load limit at maximum cold tire inflation pressure (→P. 632)

9 Maximum cold tire inflation pressure (→P. 632)

This means the pressure to which a tire may be inflated.

10 Uniform tire quality grading

For details, see "Uniform Tire Quality Grading" that follows.

11 TEMPORARY USE ONLY (→P. 582)

A compact spare tire is identified by the phrase "TEMPORARY USE ONLY" molded into its sidewall. This tire is designed for temporary emergency use only.

Typical DOT and tire identification number (TIN)

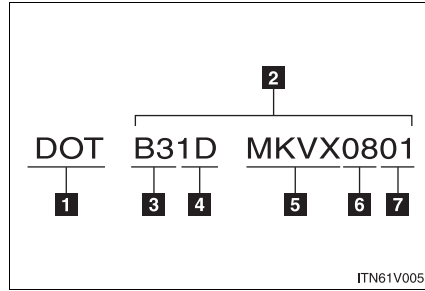

- 1** DOT symbol*
- 2** Tire Identification Number (TIN)
- 3** Tire manufacturer's identification mark
- 4** Tire size code
- 5** Manufacturer's optional tire type code (3 or 4 letters)
- 6** Manufacturing week
- 7** Manufacturing year

*: The DOT symbol certifies that the tire conforms to applicable Federal Motor Vehicle Safety Standards.

6-1. Specifications

Tire size

n Typical tire size information

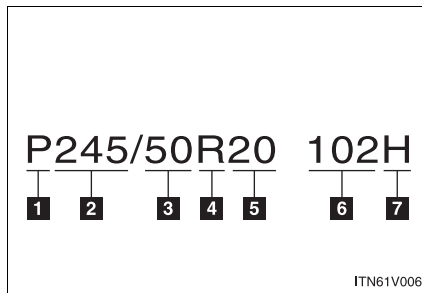

The illustration indicates typical tire size.

- 1** Tire use
(P = Passenger car,
T = Temporary use)
- 2** Section width (millimeters)
- 3** Aspect ratio
(tire height to section width)
- 4** Tire construction code
(R = Radial, D = Diagonal)
- 5** Wheel diameter (inches)
- 6** Load index (2 or 3 digits)
- 7** Speed symbol
(alphabet with one letter)

n Tire dimensions

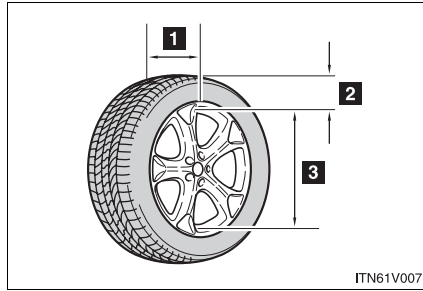

- 1 Section width
- 2 Tire height
- 3 Wheel diameter

Tire section names

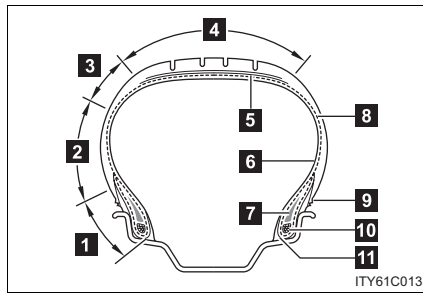

- 1 Bead
- 2 Sidewall
- 3 Shoulder
- 4 Tread
- 5 Belt
- 6 Inner liner
- 7 Reinforcing rubber
- 8 Carcass
- 9 Rim lines
- 10 Bead wires
- 11 Chafer

6

Vehicle specifications

6-1. Specifications

Uniform Tire Quality Grading

This information has been prepared in accordance with regulations issued by the National Highway Traffic Safety Administration of the U.S. Department of Transportation.

It provides the purchasers and/or prospective purchasers of Toyota vehicles with information on uniform tire quality grading.

Your Toyota dealer will help answer any questions you may have as you read this information.

n **DOT quality grades**

All passenger vehicle tires must conform to Federal Safety Requirements in addition to these grades. Quality grades can be found where applicable on the tire sidewall between tread shoulder and maximum section width.

For example: Treadwear 200 Traction AA Temperature A

n **Treadwear**

The treadwear grade is a comparative rating based on the wear rate of the tire when tested under controlled conditions on a specified government test course.

For example, a tire graded 150 would wear one and a half (1 - 1/2) times as well on the government course as a tire graded 100.

The relative performance of tires depends upon the actual conditions of their use, however, and may depart significantly from the norm due to variations in driving habits, service practices and differences in road characteristics and climate.

n Traction AA, A, B, C

The traction grades, from highest to lowest, are AA, A, B and C, and they represent the tire's ability to stop on wet pavement as measured under controlled conditions on specified government test surfaces of asphalt and concrete.

A tire marked C may have poor traction performance.

Warning: The traction grade assigned to this tire is based on braking (straight ahead) traction tests and does not include cornering (turning) traction.

n Temperature A, B, C

The temperature grades are A (the highest), B, and C, representing the tire's resistance to the generation of heat and its ability to dissipate heat when tested under controlled conditions on a specified indoor laboratory test wheel.

Sustained high temperature can cause the material of the tire to degenerate and reduce tire life, and excessive temperature can lead to sudden tire failure.

The grade C corresponds to a level of performance which all passenger car tires must meet under the Federal Motor Vehicle Safety Standard No. 109.

Grades B and A represent higher levels of performance on the laboratory test wheel than the minimum required by law.

Warning: The temperature grades for this tire are established for a tire that is properly inflated and not overloaded.

Excessive speed, underinflation, or excessive loading, either separately or in combination, can cause heat buildup and possible tire failure.

6-1. Specifications

Glossary of tire terminology

Tire related term	Meaning
Cold tire inflation pressure	Tire pressure when the vehicle has been parked for three hours or more, or has not been driven more than 1 mile or 1.5 km under that condition
Maximum inflation pressure	The maximum cold inflated pressure to which a tire may be inflated, shown on the sidewall of the tire
Recommended inflation pressure	Cold tire inflation pressure recommended by a manufacturer
Accessory weight	The combined weight (in excess of those standard items which may be replaced) of transmission, power steering, power brakes, power windows, power seats, radio and heater, to the extent that these items are available as factory-installed equipment (whether installed or not)
Curb weight	The weight of a motor vehicle with standard equipment, including the maximum capacity of fuel, oil and coolant, and if so equipped, air conditioning and additional weight optional engine
Maximum loaded vehicle weight	The sum of: (a) Curb weight (b) Accessory weight (c) Vehicle capacity weight (d) Production options weight

6-1. Specifications

Tire related term	Meaning
Normal occupant weight	150 lb. (68 kg) times the number of occupants specified in the second column of Table 1* that follows
Occupant distribution	Distribution of occupants in a vehicle as specified in the third column of Table 1* below
Production options weight	The combined weight of installed regular production options weighing over 5 lb. (2.3 kg) in excess of the standard items which they replace, not previously considered in curb weight or accessory weight, including heavy duty brakes, ride levelers, roof rack, heavy duty battery, and special trim
Rim	A metal support for a tire or a tire and tube assembly upon which the tire beads are seated
Rim diameter (Wheel diameter)	Nominal diameter of the bead seat
Rim size designation	Rim diameter and width
Rim type designation	The industry manufacturer's designation for a rim by style or code
Rim width	Nominal distance between rim flanges
Vehicle capacity weight (Total load capacity)	The rated cargo and luggage load plus 150 lb. (68 kg) times the vehicle's designated seating capacity

6

Vehicle specifications

6-1. Specifications

Tire related term	Meaning
Vehicle maximum load on the tire	The load on an individual tire that is determined by distributing to each axle its share of the maximum loaded vehicle weight, and dividing by two
Vehicle normal load on the tire	The load on an individual tire that is determined by distributing to each axle its share of curb weight, accessory weight, and normal occupant weight (distributed in accordance with Table 1* below), and dividing by two
Weather side	The surface area of the rim not covered by the inflated tire
Bead	The part of the tire that is made of steel wires, wrapped or reinforced by ply cords and that is shaped to fit the rim
Bead separation	A breakdown of the bond between components in the bead
Bias ply tire	A pneumatic tire in which the ply cords that extend to the beads are laid at alternate angles substantially less than 90 degrees to the centerline of the tread
Carcass	The tire structure, except tread and sidewall rubber which, when inflated, bears the load
Chunking	The breaking away of pieces of the tread or sidewall

6-1. Specifications

Tire related term	Meaning
Cord	The strands forming the plies in the tire
Cord separation	The parting of cords from adjacent rubber compounds
Cracking	Any parting within the tread, sidewall, or innerliner of the tire extending to cord material
CT	A pneumatic tire with an inverted flange tire and rim system in which the rim is designed with rim flanges pointed radially inward and the tire is designed to fit on the underside of the rim in a manner that encloses the rim flanges inside the air cavity of the tire
Extra load tire	A tire designed to operate at higher loads and at higher inflation pressures than the corresponding standard tire
Groove	The space between two adjacent tread ribs
Innerliner	The layer(s) forming the inside surface of a tubeless tire that contains the inflating medium within the tire
Innerliner separation	The parting of the innerliner from cord material in the carcass

6-1. Specifications

Tire related term	Meaning
Intended outboard sidewall	(a)The sidewall that contains a whitewall, bears white lettering, or bears manufacturer, brand, and/or model name molding that is higher or deeper than the same molding on the other sidewall of the tire, or (b)The outward facing sidewall of asymmetrical tire that has a particular side that must always face outward when mounted on a vehicle
Light truck (LT) tire	A tire designated by its manufacturer as primarily intended for use on lightweight trucks or multipurpose passenger vehicles
Load rating	The maximum load that a tire is rated to carry for a given inflation pressure
Maximum load rating	The load rating for a tire at the maximum permissible inflation pressure for that tire
Maximum permissible inflation pressure	The maximum cold inflation pressure to which a tire may be inflated
Measuring rim	The rim on which a tire is fitted for physical dimension requirements
Open splice	Any parting at any junction of tread, sidewall, or innerliner that extends to cord material
Outer diameter	The overall diameter of an inflated new tire
Overall width	The linear distance between the exteriors of the sidewalls of an inflated tire, including elevations due to labeling, decorations, or protective bands or ribs

6-1. Specifications

Tire related term	Meaning
Passenger car tire	A tire intended for use on passenger cars, multipurpose passenger vehicles, and trucks, that have a gross vehicle weight rating (GVWR) of 10,000 lb. or less
Ply	A layer of rubber-coated parallel cords
Ply separation	A parting of rubber compound between adjacent plies
Pneumatic tire	A mechanical device made of rubber, chemicals, fabric and steel or other materials, that, when mounted on an automotive wheel, provides the traction and contains the gas or fluid that sustains the load
Radial ply tire	A pneumatic tire in which the ply cords that extend to the beads are laid at substantially 90 degrees to the centerline of the tread
Reinforced tire	A tire designed to operate at higher loads and at higher inflation pressures than the corresponding standard tire
Section width	The linear distance between the exteriors of the sidewalls of an inflated tire, excluding elevations due to labeling, decoration, or protective bands
Sidewall	That portion of a tire between the tread and bead
Sidewall separation	The parting of the rubber compound from the cord material in the sidewall

6

Vehicle specifications

6-1. Specifications

Tire related term	Meaning
Snow tire	A tire that attains a traction index equal to or greater than 110, compared to the ASTM E-1136 Standard Reference Test Tire, when using the snow traction test as described in ASTM F-1805-00, Standard Test Method for Single Wheel Driving Traction in a Straight Line on Snow-and Ice-Covered Surfaces, and which is marked with an Alpine Symbol () on at least one sidewall
Test rim	The rim on which a tire is fitted for testing, and may be any rim listed as appropriate for use with that tire
Tread	That portion of a tire that comes into contact with the road
Tread rib	A tread section running circumferentially around a tire
Tread separation	Pulling away of the tread from the tire carcass
Treadwear indicators (TWI)	The projections within the principal grooves designed to give a visual indication of the degrees of wear of the tread
Wheel-holding fixture	The fixture used to hold the wheel and tire assembly securely during testing

6-1. Specifications

*: Table 1 — Occupant loading and distribution for vehicle normal load for various designated seating capacities

Designated seating capacity, Number of occupants	Vehicle normal load, Number of occupants	Occupant distribution in a normally loaded vehicle
2 through 4	2	2 in front
5 through 10	3	2 in front, 1 in second seat
11 through 15	5	2 in front, 1 in second seat, 1 in third seat, 1 in fourth seat
16 through 20	7	2 in front, 2 in second seat, 2 in third seat, 1 in fourth seat

6-2. Customization Customizable features

Your vehicle includes a variety of electronic features that can be personalized to your preferences. Programming these preferences requires specialized equipment and may be performed by an authorized Toyota dealership.

Some function settings are changed simultaneously with other functions being customized. Contact your Toyota dealer for further details.

▶ **Vehicles with TFT type multi-information display**

Some function settings can be changed by operating the multi-information display.

Customizable features

Item	Function	Default setting	Customized setting
Wireless remote control (→P. 43)	Wireless remote control	ON	OFF
	Unlocking operation*	Driver's door unlocked in one step, all doors unlocked in two steps	All doors unlocked in one step
	Automatic door locking function (if a door is not opened after being unlocked)*	ON	OFF
	Time elapsed before automatic door lock function is activated if door is not opened after being unlocked*	60 seconds	30 seconds
	120 seconds		

Item	Function	Default setting	Customized setting
Wireless remote control (→P. 43)	Operation signal (Emergency flashers)*	ON	OFF
	Operation signal (Buzzer)	ON	OFF
	Operation signal (Buzzer volume)	Level 7	Level 1 to 6
			OFF
	Open door warning function (when locking the vehicle)	ON	OFF
Panic function	ON	OFF	
Door lock (→P. 48)	Unlocking using a key	Driver's door unlocked in one step, all doors unlocked in two steps	All doors unlocked in one step
	Speed-detecting automatic door lock function*	OFF	ON
	Shifting the shift lever to position other than "P" locks all doors*	ON	OFF
	Shifting the shift lever to "P" unlocks all doors*	ON	OFF
	Opening driver's door unlocks all doors*	OFF	ON

6-2. Customization

Item	Function	Default setting	Customized setting
Smart key system (→P. 28)	Smart key system	ON	OFF
	Operation signal (Emergency flashers)	ON	OFF
	Operation signal (Buzzer)	ON	OFF
Automatic light control system (→P. 198)	Light sensor sensitivity	Level 3	Level 1 to 5
	Daytime running light system (U.S.A. only)	ON	OFF
	Automatic High Beam (if equipped)*	ON	OFF
	Time elapsed before headlights automatically turn off after doors are closed*	30 seconds	0 seconds
60 seconds			
90 seconds			
Alarm system (→P. 100)	Time elapsed before the alarm is set	14 seconds	30 seconds
Multi-information display (→P. 180)	Language selection*	English	French
			Spanish

Item	Function	Default setting	Customized setting
Illumination (→P. 391)	Time period before lights turn off*	15 seconds	7.5 seconds
			30 seconds
	Vehicles with smart key system: Operation after the "ENGINE START STOP" switch is turned off Vehicles without smart key system: Operation after the engine switch is turned to the "LOCK" position	ON	OFF
	Operation when the doors are unlocked	ON	OFF
	Operation when you approach the vehicle with the electronic key on your person (When the personal/interior light main switch is door position.) (vehicles with smart key system)	ON	OFF
Seat belt reminder (→P. 563)	Vehicle speed linked seat belt reminder buzzer	ON	OFF

*: For vehicles with TFT type multi-information display, the setting can be changed by operating the multi-information display. (→P. 644)

6-2. Customization

Customizing the features by using the multi-information display (vehicles with TFT type multi-information display)

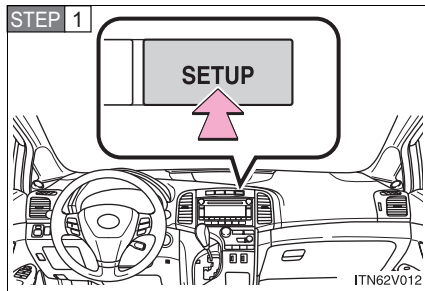

Press the “SETUP” button while the vehicle is stopped.

The “Custom Settings” screen is displayed on the multi-information display.

If left idle for approximately 10 seconds, the display will revert to the previous screen.

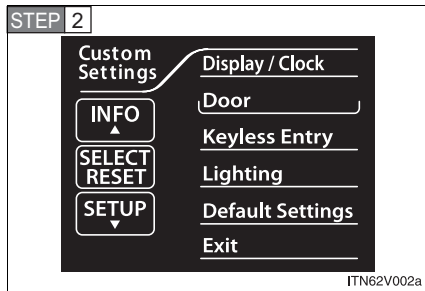

Select the setting you wish to change by pressing the “INFO” or “SETUP” button, and press the “SELECT RESET” button.

If you select “Exit” and press the “SELECT RESET” button, the display will revert to the previous screen.

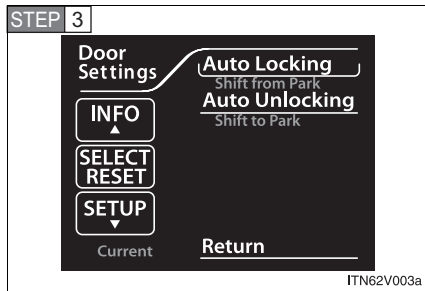

Select the setting you wish to change by pressing the “INFO” or “SETUP” button, and press the “SELECT RESET” button.

The illustration assumes that “Door” was chosen in **STEP 2**.

The current setting is indicated by yellow text.

If you select “Return” and press the “SELECT RESET” button, the display will revert to the “Custom Settings” screen.

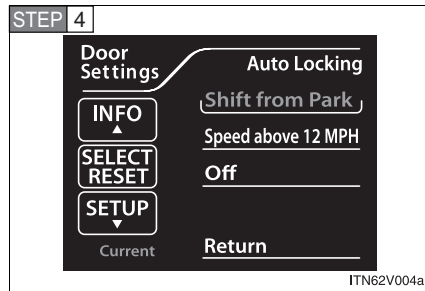

Choose a desired setting by pressing the "INFO" or "SETUP" button, and press the "SELECT RESET" button.

If any settings are changed, the display will revert to the previous screen.

The illustration assumes that "Auto Locking" was chosen in **STEP 3**.

The current setting is indicated by yellow text.

If you select "Return" and press the "SELECT RESET" button, the display will revert to the previous screen.

n Restoring default settings

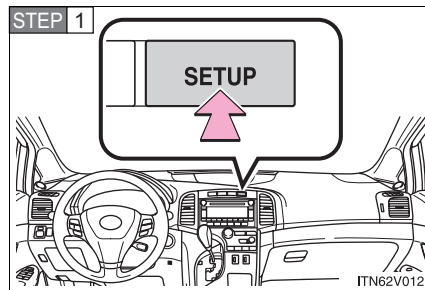

Press the "SETUP" button while the vehicle is stopped.

The "Custom Settings" screen is displayed on the multi-information display.

If left idle for approximately 10 seconds, the display will revert to the previous screen.

6-2. Customization

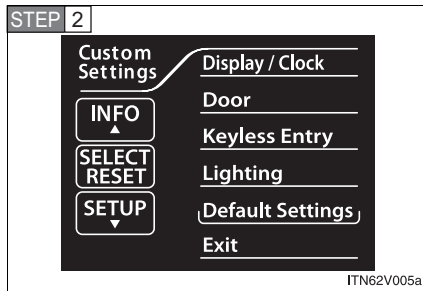

Select “Default Settings” by pressing the “INFO” or “SETUP” button, and press the “SELECT RESET” button.

If you select “Exit” and press the “SELECT RESET” button, the display will revert to the previous screen.

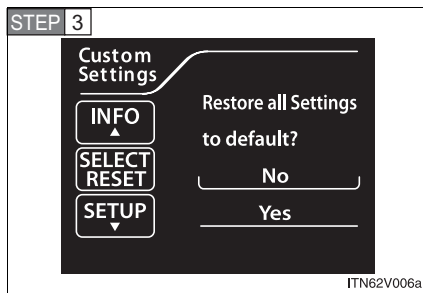

Select “Yes” by pressing the “INFO” or “SETUP” button, and press the “SELECT RESET” button.

“Default Settings Restored” is displayed, and the default settings are restored.

If you select “No” and press the “SELECT RESET” button, the display will revert to the “Custom Settings” screen without restoring the default settings.

n If the vehicle is moved while settings are being changed on the multi-information display

→P. 192

6-3. Initialization Items to initialize

The following items must be initialized for normal system operation in cases such as after the battery is reconnected, or maintenance is performed on the vehicle.

Item	When to initialize	Reference
Power back door	<ul style="list-style-type: none"> • After reconnecting or changing the battery • After changing a fuse 	P. 57
Engine oil maintenance data (U.S.A. only)	After changing engine oil	P. 495

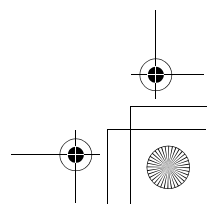
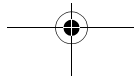
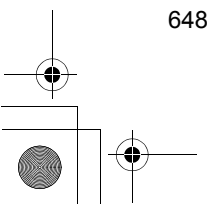
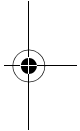
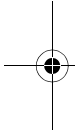
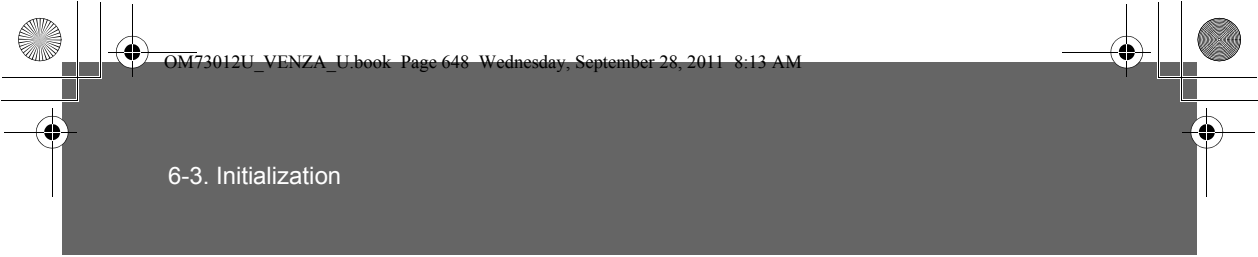

For owners

7

Reporting safety defects for U.S. owners	650
Seat belt instructions for Canadian owners (in French)	651
SRS airbag instructions for Canadian owners (in French)	653

Reporting safety defects for U.S. owners

If you believe that your vehicle has a defect which could cause a crash or could cause injury or death, you should immediately inform the National Highway Traffic Safety Administration (NHTSA) in addition to notifying Toyota Motor Sales, U.S.A., Inc. (Toll-free: 1-800-331-4331).

If NHTSA receives similar complaints, it may open an investigation, and if it finds that a safety defect exists in a group of vehicles, it may order a recall and remedy campaign. However, NHTSA cannot become involved in individual problems between you, your dealer, or Toyota Motor Sales, U.S.A., Inc.

To contact NHTSA, you may call the Vehicle Safety Hotline toll-free at 1-888-327-4236 (TTY: 1-800-424-9153); go to <http://www.safercar.gov>; or write to: Administrator, NHTSA, 1200 New Jersey Ave, S.E., Washington, DC 20590. You can also obtain other information about motor vehicle safety from <http://www.safercar.gov>.

Seat belt instructions for Canadian owners (in French)

The following is a French explanation of seat belt instructions extracted from the seat belt section in this manual.

See the seat belt section for more detailed seat belt instructions in English.

Utilisation adéquate des ceintures de sécurité

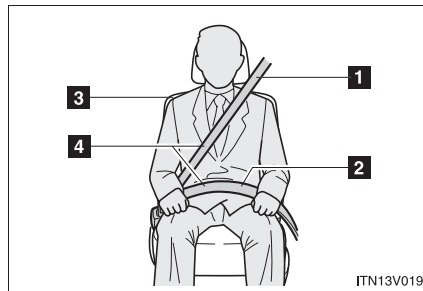

- 1** Tirez sur la ceinture épaulière jusqu'à ce qu'elle recouvre entièrement l'épaule; elle ne doit cependant pas toucher le cou ni glisser de l'épaule.
- 2** Placez la sangle abdominale le plus bas possible sur les hanches.
- 3** Réglez la position du dossier du siège. Tenez-vous assis dans le fond du siège, le dos droit.
- 4** Ne vrillez pas la ceinture de sécurité.

Entretien et soin

■ Ceintures de sécurité

Avec un tissu ou une éponge, nettoyez à l'aide d'un savon doux et de l'eau tiède. Vérifiez aussi les ceintures régulièrement pour vous assurer qu'elles ne présentent pas d'usure excessive, d'effilochage ou de coupures.

⚠ ATTENTION

■ Dommages et usure de la ceinture de sécurité

Vérifiez périodiquement le système de ceintures de sécurité. Assurez-vous qu'il n'y a pas de coupures, d'effilochures ni de pièces desserrées. N'utilisez pas une ceinture de sécurité endommagée avant qu'elle soit remplacée. Les ceintures de sécurité endommagées ne peuvent pas protéger les occupants contre les blessures.

SRS airbag instructions for Canadian owners (in French)

The following is a French explanation of SRS airbag instructions extracted from the SRS airbag section in this manual.

See the SRS airbag section for more detailed SRS airbag instructions in English.

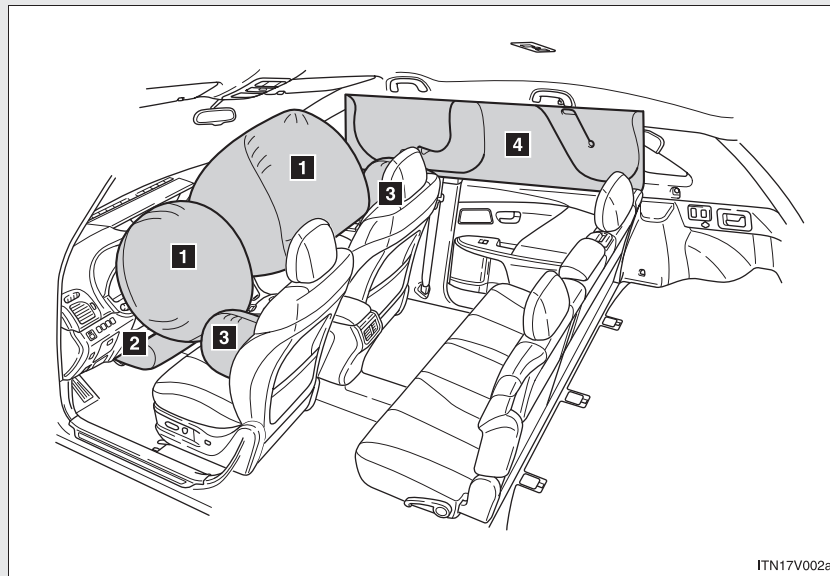

► Coussins gonflables avant

- 1** Coussins gonflables du conducteur/du passager avant
Peuvent protéger la tête et la poitrine du conducteur et du passager avant contre les impacts avec des composants intérieurs.
- 2** Coussin de protection des genoux
Peut protéger le conducteur.

7

For owners

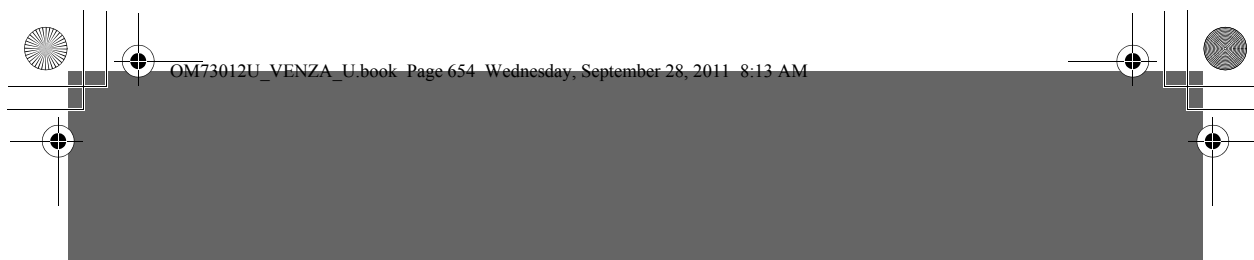

- ▶ Coussins gonflables latéraux et en rideau
- 3 Coussins gonflables latéraux
Peuvent protéger le torse des occupants des sièges avant.
- 4 Coussins gonflables en rideau
Peuvent surtout protéger la tête des occupants sièges avant et des occupants des sièges latéraux arrière.

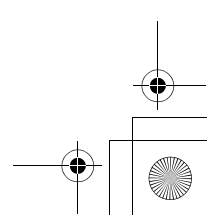
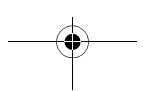
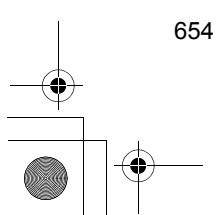
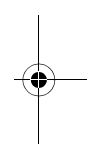
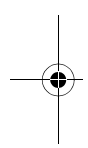

Composants du système de coussins gonflables

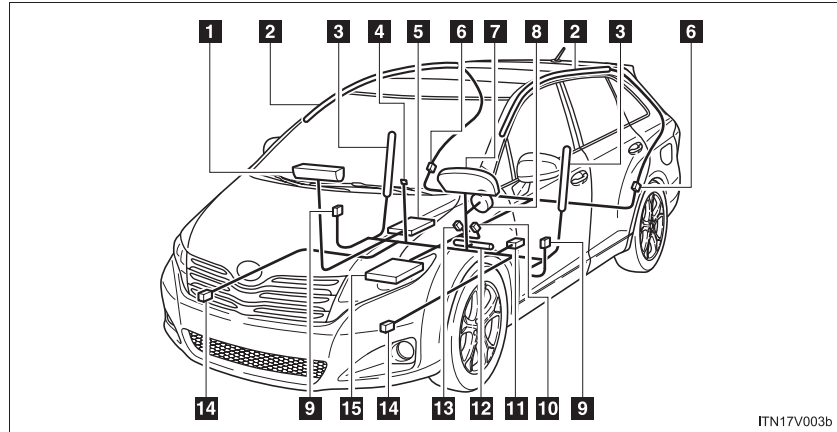

- | | |
|--|--|
| 1 Coussin gonflable du passager avant | 10 Contacteur de boucle de ceinture de sécurité du conducteur |
| 2 Coussin gonflable en rideau | 11 Capteur de position de siège du conducteur |
| 3 Coussin gonflable latéral | 12 Coussin de protection des genoux |
| 4 Lampe témoin "AIR BAG ON/OFF" | 13 Contacteur de boucle de ceinture de sécurité du passager avant |
| 5 Capteur de détection d'occupant | 14 Capteur de coussins gonflables avant |
| 6 Capteur du coussin gonflable en rideau | 15 Module de capteur de coussin gonflable |
| 7 Lampe témoin SRS | |
| 8 Coussin gonflable du conducteur | |
| 9 Capteur des coussins gonflables latéraux et en rideau | |

7

For owners

Votre véhicule est doté de COUSSINS GONFLABLES ÉVOLUÉS dont la conception s'appuie sur les normes de sécurité des véhicules à moteur américains (FMVSS208). Le système de coussins gonflables contrôle la puissance de déploiement des coussins du conducteur et du passager avant. Le système de coussin gonflable du conducteur est constitué du capteur de position du siège du conducteur, etc. Le système de coussin gonflable du passager avant est constitué du capteur de classification de l'occupant du siège du passager avant, etc.

Les composants principaux du système de coussins gonflables SRS sont illustrés ci-dessus. Le système de coussins gonflables SRS est contrôlé par le module de capteur de coussin gonflable. Le module de capteur de coussin gonflable est constitué d'un capteur de sûreté et d'un capteur de coussin gonflable.

Lors de certains types de collisions frontales ou latérales violentes, le système de coussins gonflables SRS déclenche les gonfleurs des coussins. Une réaction chimique se produit dans les gonfleurs et les coussins gonflables se remplissent rapidement d'un gaz non toxique pour empêcher tout mouvement des occupants.

 **ATTENTION**
■ Précautions relatives aux coussins gonflables SRS

Observez les précautions suivantes en ce qui concerne les coussins gonflables.

Les négliger pourrait occasionner des blessures graves, voire mortelles.

- Le conducteur et tous les passagers du véhicule doivent porter leur ceinture de sécurité de la manière appropriée.

Les coussins gonflables SRS sont des dispositifs supplémentaires qui doivent être utilisés de concert avec les ceintures de sécurité.

- Le coussin gonflable SRS du conducteur se déploie avec une force considérable et peut occasionner des blessures graves, voire mortelles, notamment lorsque le conducteur se trouve très près du coussin gonflable. La National Highway Traffic Safety Administration ("NHTSA"), aux États-Unis, donne les recommandations suivantes:

La zone à risque d'un coussin gonflable côté conducteur couvre 2 à 3 in. (50 à 75 mm) de la zone de déploiement du coussin gonflable. Pour assurer une marge de sécurité suffisante, restez à 10 in. (250 mm) du coussin gonflable. Cette distance est mesurée depuis le centre du volant jusqu'à votre sternum. Si vous vous tenez à moins de 10 in. (250 mm), vous pouvez changer votre position de conduite de plusieurs manières:

- Reculez votre siège à la position maximale vous permettant d'atteindre encore aisément les pédales.
- Inclinez légèrement le dossier du siège.
Même si les véhicules sont conçus différemment, la plupart des conducteurs peuvent maintenir une distance de 10 in. (250 mm), même si le siège se trouve complètement vers l'avant, simplement en inclinant un peu le dossier du siège vers l'arrière. Si la visibilité avant est moindre après avoir incliné le dossier du siège, utilisez un coussin ferme et non glissant pour être assis plus haut ou relevez l'assise du siège si cette option est disponible sur votre véhicule.
- Si votre volant est réglable en hauteur, inclinez-le vers le bas. Cela vous permet d'orienter le coussin gonflable vers votre buste plutôt que vers la tête et le cou.

Le siège doit être réglé de la manière recommandée ci-dessus par la NHTSA, tout en gardant le contrôle des pédales, du volant et la vue des commandes et des instruments.

ATTENTION

Précautions relatives aux coussins gonflables SRS

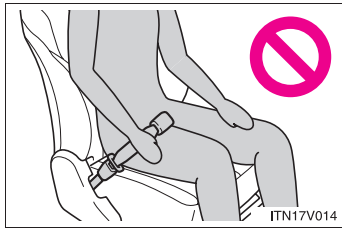

● Si la rallonge de ceinture de sécurité a été reliée à la boucle de ceinture de sécurité du conducteur sans avoir été attachée à la plaque de blocage de la ceinture de sécurité du conducteur, le système de coussin gonflable SRS du conducteur considérera que le conducteur porte tout de même sa ceinture même si elle n'est pas attachée. Le coussin gonflable du conducteur peut alors ne pas s'activer correctement lors d'une collision, ce qui représente un risque de blessures graves, voire mortelles. Bouclez toujours votre ceinture de sécurité lorsque vous utilisez la rallonge.

● Le coussin gonflable SRS du passager avant se déploie également avec une force considérable et peut occasionner des blessures graves, voire mortelles, notamment lorsque le passager avant se trouve très près du coussin gonflable. Le siège du passager avant doit se trouver le plus loin possible du coussin gonflable et le dossier doit être réglé de manière à ce que le passager avant soit assis bien droit.

 **ATTENTION****■ Précautions relatives aux coussins gonflables SRS**

- Le déploiement d'un coussin gonflable risque d'infliger des blessures graves, voire mortelles, aux bébés et aux enfants mal assis et/ou mal attachés. Un bébé ou un enfant trop petit pour utiliser une ceinture de sécurité doit être correctement retenu à l'aide d'un dispositif de retenue pour enfants. Toyota recommande vivement de placer et d'attacher correctement tous les bébés et enfants sur les sièges arrière du véhicule à l'aide de systèmes de retenue adaptés. Les sièges arrière constituent en effet l'endroit le plus sûr pour les bébés et les enfants.
- N'installez jamais un dispositif de retenue pour enfants de type dos à la route sur le siège du passager avant, même si la lampe témoin "AIR BAG OFF" s'allume. En cas d'accident, la force et la vitesse de déploiement du coussin gonflable du passager avant sont telles qu'elles pourraient infliger à l'enfant des blessures graves, voire mortelles, si le dispositif de retenue pour enfants du type dos à la route était installé sur le siège du passager avant.

! ATTENTION

■ Précautions relatives aux coussins gonflables SRS

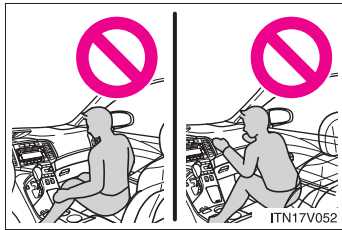

● Ne vous asseyez pas sur le bord du siège et ne vous appuyez pas sur le tableau de bord.

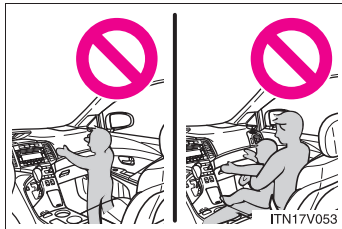

● Ne laissez pas un enfant se tenir face au coussin gonflable SRS du passager avant ou s'asseoir sur les genoux d'un passager avant.

● Ne conduisez pas le véhicule si vous ou le passager avez quelque chose sur les genoux.



● Ne vous appuyez pas sur la portière ou sur le longeron du toit, ni sur les montants avant, centraux ou arrière.



● Ne laissez personne s'agenouiller face à la portière sur le siège du passager ou sortir la tête ou les mains à l'extérieur du véhicule.

ATTENTION

Précautions relatives aux coussins gonflables SRS

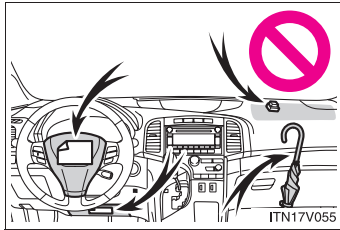

- Ne fixez et n'appuyez rien sur le tableau de bord, le tampon de volant ou la partie inférieure du bloc d'instrumentation. Ces objets peuvent se transformer en projectiles lorsque les coussins gonflables SRS du conducteur, du passager avant ou de protection des genoux se déploient.



- Ne fixez rien sur les portières, le pare-brise, les glaces latérales, les montants avant, central et arrière, le longeron du toit ou la poignée de maintien.

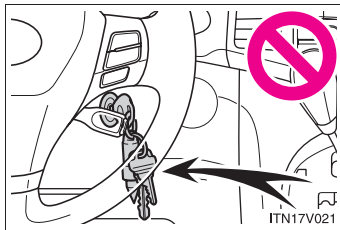

- N'accrochez pas de cintres ni d'autres objets rigides sur les crochets porte-vêtements. Tous ces objets pourraient se transformer en projectiles et vous occasionner des blessures graves, voire mortelles, en cas de déploiement du coussin gonflable SRS en rideau.

- Véhicules non dotés du système Smart key: N'accrochez pas d'objets lourds, aiguisés ou durs, par exemple des clés ou des accessoires, à la clé. Ces objets pourraient empêcher le déploiement du coussin SRS de protection des genoux ou être projetés dangereusement sur le siège du conducteur par la force du déploiement, et donc vous mettre en danger.

 **ATTENTION****■ Précautions relatives aux coussins gonflables SRS**

- Si le recouvrement de vinyle est placé sur la zone de déploiement du coussin SRS de protection des genoux, veillez à le retirer.
- N'utilisez pas d'accessoires recouvrant les parties du siège où les coussins gonflables SRS latéraux se déploient, car ceux-ci pourraient nuire au déploiement de ces coussins.
- Ne frappez pas et n'appliquez pas une pression importante à l'emplacement des composants de coussins gonflables SRS (→P. 653). Ces actions peuvent entraîner un mauvais fonctionnement des coussins gonflables SRS.
- Ne touchez à aucun composant des coussins gonflables SRS immédiatement après leur déploiement (gonflage), car ils pourraient être chauds.
- Si vous avez de la difficulté à respirer après le déploiement d'un coussin gonflable SRS, ouvrez une portière ou une glace pour laisser entrer l'air, ou quittez le véhicule si vous pouvez le faire en toute sécurité. Dès que possible, nettoyez tous les résidus afin d'éviter les irritations cutanées.
- Si les emplacements de stockage des coussins gonflables SRS, notamment le tampon de volant et les garnitures des montants avant, central et arrière, sont endommagés ou fissurés, faites-les remplacer par votre concessionnaire Toyota.

 **ATTENTION****■ Modification et mise au rebut des composants du système de coussins gonflables SRS**

Ne mettez pas le véhicule à la casse et n'effectuez aucune des modifications suivantes sans d'abord consulter votre concessionnaire Toyota.

Le coussin gonflable SRS pourrait fonctionner de manière incorrecte ou se déployer (gonfler) accidentellement, ce qui serait susceptible d'occasionner des blessures graves, voire mortelles.

- Installation, retrait, démontage et réparation des coussins gonflables SRS
- Réparations, modifications, retrait ou remplacement du volant, du bloc d'instrumentation, du tableau de bord, des sièges ou du capitonnage des sièges, des montants avant, central ou arrière et du longeron du toit
- Réparations ou modifications de l'aile ou du pare-chocs avant, ou du côté de l'habitacle
- Installation de lames de déneigement, de treuils, etc. sur la calandre avant (barre safari, barre kangourou, etc.)
- Modifications du système de suspension du véhicule
- Installation d'appareils électroniques tels qu'un émetteur-récepteur radio ou un lecteur de CD
- Modifications à votre véhicule pour une personne aux capacités physiques réduites

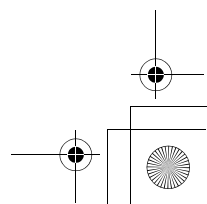
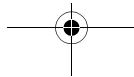
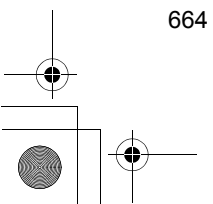
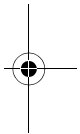
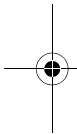
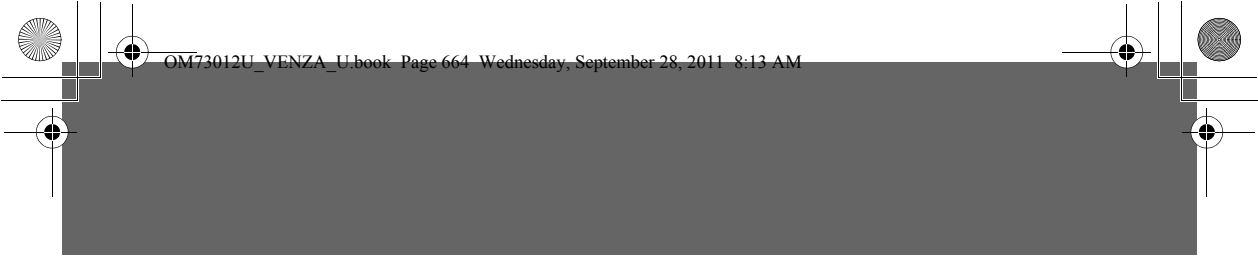

Index

Abbreviation list	666
Alphabetical index	668
What to do if.....	676

For details of equipment related to the navigation system and touch screen, such as the audio systems, refer to the "Navigation System Owner's Manual".

Abbreviation list

Abbreviation/Acronym list

ABBREVIATIONS	MEANING
2WD	2-Wheel Drive
4WD	4-Wheel Drive
ABS	Anti-lock Brake System
ACC	Accessory
ALR	Automatic Locking Retractor
AUX	Auxiliary
AWD	All-Wheel Drive
A/C	Air Conditioning
CRS	Child Restraint System
ECON	Economy
ECU	Electronic Control Unit
EDR	Event Data Recorder
ELR	Emergency Locking Retractor
EPS	Electric Power Steering
GAWR	Gross Axle Weight Rating
GVWR	Gross Vehicle Weight Rating
INFO	Information
I/M	Emission inspection and maintenance
LATCH	Lower Anchors and Tether for Children
LCD	Liquid Crystal Display
LED	Light Emitting Diode
MMT	Methylcy clopentadienyl Manganese Tricarbonyl
M+S	Mud and Snow
MTBE	Methyl Tertiary Butyl Ether

Abbreviation list

ABBREVIATIONS	MEANING
OBD	On Board Diagnostics
PASS	Passenger
PWR	Power
P/S	Power Steering
SRS	Supplemental Restraint System
TEMP	Temperature
TFT	Thin Film Transistor
TIN	Tire Identification Number
TPMS	Tire Pressure Warning System
TRAC	Traction Control
VIN	Vehicle Identification Number
VSC	Vehicle Stability Control

Alphabetical index

Alphabetical index

A

A/C

- Air conditioning filter.....520
- Automatic air conditioning system262
- Manual air conditioning system272

ABS224

Active head restraint65

Active Torque Control 4WD

- system224

Air conditioning filter.....520

Air conditioning system

- Air conditioning filter.....520
- Automatic air conditioning system262

Airbags

- Airbag operating conditions... 111
- Airbag precautions for your child 115
- Airbag warning light.....562
- Curtain shield airbag operating conditions..... 111
- Curtain shield airbag precautions 115
- Front passenger occupant classification system 122
- General airbag precautions... 115
- Locations of airbags 107
- Modification and disposal of airbags 120
- Proper driving posture... 105, 115
- Side airbag operating conditions..... 111
- Side airbag precautions 115
- SRS airbags 107

Alarm 100

Antenna.....290

Anti-lock brake system.....224

Armrest452

Audio input.....333

Audio system

- A/V input port380
- Antenna.....290
- Audio input333
- AUX port333
- CD player/changer293
- iPod.....313
- MP3/WMA disc303
- Optimal use.....328
- Portable music player333
- Radio.....284
- Rear seat entertainment system356
- Steering wheel audio switch.....334
- USB memory.....320
- Video CD.....374

Automatic air conditioning

- system262

Automatic headlight leveling

- system 198

Automatic High Beam202

Automatic light control

- system 198

Automatic transmission

- Automatic transmission..... 166
- If the shift lever cannot be shifted from "P" 590
- S mode.....168

AUX port333

Auxiliary box442

A/V input port.....380

B

Back door

- Back door.....54
- Wireless remote control key....43

Back-up lights

- Replacing light bulbs537
- Wattage.....621

Battery

- Checking502

	If the vehicle has discharged battery 595
	Preparing and checking before winter 242
	Bluetooth® audio..... 338
	Bluetooth® phone..... 391
	Bottle holder..... 441
	Brake
	Fluid..... 500
	Parking brake 172
	Brake assist..... 224
	Break-in tips 150
	Brightness control
	Instrument light control..... 175
C	Care
	Exterior 470
	Interior 473
	Seat belts 474
	Cargo capacity 235
	Cargo hooks 455
	CD player/changer 293
	Chains 244
	Child-protectors 50
	Child restraint system
	Booster seats, definition 127
	Booster seats, installation 133
	Convertible seats, definition..... 127
	Convertible seats, installation 133
	Front passenger occupant classification system 121
	Infant seats, definition 127
	Infant seats, installation..... 133
	Installing child restraint system with lower anchorage 134
	Installing child restraint system with seatbelts..... 137
	Installing child restraint system with top straps 142

	Child safety
	Airbag precautions 115
	Battery precautions 504, 526
	Child-protectors.....50
	Child restraint system.....127
	How your child should wear the seat belt75
	Installing child restraints.....133
	Moon roof precautions91
	Power window lock switch.....85
	Power window precautions88
	Removed key battery precautions523
	Seat belt extender precautions78
	Seat belt precautions76
	Seat heater precautions450
	Cleaning
	Exterior.....470
	Interior473
	Seat belts474
	Clock 180, 194
	Compass.....464
	Condenser499
	Console box436
	Cooling system
	Engine overheating600
	Cruise control.....213
	Cup holder439
	Curtain shield airbags107
	Customizable features.....640

D	Daytime running light system 199
	Defogger
	Rear window278
	Dimension.....608
	Dinghy towing259
	Display
	Shift position and shift range..... 168

Alphabetical index

Trip information 180, 194
 Warning messages575
Do-it-yourself maintenance.....482
Door courtesy lights
 Door courtesy lights430
 Wattage.....621
Door lock
 Back door54
 Side door.....48
 Wireless remote control key...43
Doors
 Back door54
 Side door.....48
 Side mirrors.....82
Driver's seat belt reminder light.....563
Driving
 Break-in tips 150
 Correct posture 105
 Procedures..... 148
 Utility vehicle precautions.....230
 Winter driving tips.....242

E **Electric power steering224**
Electronic key
 If your electronic key battery is discharged...523, 592
Emergency, in case of
 If a warning message is displayed.....575
 If the electronic key does not operate properly.....592
 If the engine will not start587
 If the shift lever cannot be shifted from "P"590
 If the vehicle has discharged battery595
 If the warning buzzer sounds560
 If the warning light turns on...560
 If you have a flat tire576
 If you lose your keys591

If you think something is wrong.....555
 If your vehicle becomes stuck 603
 If your vehicle has to be stopped in an emergency ...605
 If your vehicle needs to be towed.....551
 If your vehicle overheats.....600
Emergency flashers.....550
Engine
 Compartment490
 Engine switch..... 159, 163
 Hood486
 How to start the engine..... 159, 163
 Identification number.....609
 If the engine will not start587
 Ignition switch 159, 163
 Overheating600
Engine coolant
 Capacity615
 Checking497
 Preparing and checking before winter.....242
Engine coolant temperature gauge.....174
Engine immobilizer system97
Engine oil
 Capacity612
 Checking492
 Preparing and checking before winter.....242
Engine oil maintenance data495
Engine switch.....159
EPS.....224
Event data recorder558

F	Floor mat	453
	Fluid	
	Brake	500
	Washer	505
	Fog lights	
	Replacing light bulbs	537
	Switch	209
	Wattage	621
	Four-wheel drive system	224
	Front fog lights	
	Replacing light bulbs	537
	Switch	209
	Wattage	621
	Front passenger occupant classification system	121
	Front passenger's seat belt reminder light	563
	Front seats	
	Adjustment	64
	Front side marker light	
	Replacing light bulbs	537
	Wattage	621
	Front turn signal lights	
	Replacing light bulbs	537
	Wattage	621
	Fuel	
	Capacity	611
	Fuel gauge	174
	Fuel pump shut off system ...	557
	Information	622
	Refueling	93
	Type	622
	Fuel door	93
	Fuel filler door	93
	Fuel pump shut off system	557
	Fuses	527
G	Garage door opener	457
	Gauges	174
	Glove box	435
	Glove box light	435

H	Hands-free system (for cellular phone)	391
	Head restraints	
	Adjusting	70
	Headlights	
	Replacing light bulbs	537
	Switch	198
	Wattage	621
	Heaters	
	Seat heaters	450
	Side mirror	278
	Hill-start assist control	222
	Hood	486
	Hooks	
	Cargo hook	455
	Shopping bag hooks	455
	Horn	173
I	I/M test	481
	Identification	
	Engine	609
	Vehicle	609
	Ignition	
	Engine switch	159, 163
	Keys	26
	Ignition switch	159, 163
	Ignition switch	159, 163
	Illuminated entry system	430
	Indicator lights	177
	Initialization	
	Items to initialize	647
	Inside rear view mirror	80
	Instrument panel light control	175
	Interior lights	
	Interior lights	430
	Switch	431
	Wattage	621

Alphabetical index

J	<p>Jack</p> <ul style="list-style-type: none"> Positioning a floor jack 488 Vehicle-equipped jack 576 <p>Jack handle 576</p>	M	<p>Load capacity 240</p> <p>Lock steering column 159, 163</p> <p>Luggage compartment light</p> <ul style="list-style-type: none"> Switch 432 Wattage 621 <p>Luggage cover 455</p>
K	<p>Keyless entry 28</p> <p>Keys</p> <ul style="list-style-type: none"> Electronic key 26 If you lose your keys 591 If your electronic key battery is discharged... 523, 592 Ignition switch 159, 163 Keyless entry 28 Key number 26 Keys 26 Mechanical key 26 Wireless remote control key ... 43 <p>Knee airbag 107</p>	N	<p>Maintenance</p> <ul style="list-style-type: none"> Do-it-yourself maintenance ... 482 General maintenance 478 Maintenance data 608 Maintenance requirements ... 476 <p>Manual air conditioning system 272</p> <p>Meter</p> <ul style="list-style-type: none"> Instrument panel light control 175 Meters 174 <p>Mirrors</p> <ul style="list-style-type: none"> Inside rear view mirror 80 Side mirror heater 278 Side mirrors 82 Vanity mirrors 446 <p>Moon roof 89</p> <p>MP3 disc 303</p> <p>Multi-information display 180, 194</p>
L	<p>Language</p> <ul style="list-style-type: none"> Multi-information display 180, 640 <p>Licence plate lights</p> <ul style="list-style-type: none"> Replacing light bulbs 537 Wattage 621 <p>Light bulbs</p> <ul style="list-style-type: none"> Replacing 537 Wattage 621 <p>Lights</p> <ul style="list-style-type: none"> Door courtesy lights 430 Fog light switch 209 Headlights switch 198 Interior light switch 431 Personal light switch 432 Replacing light bulbs 537 Turn signal lever 171 Vanity lights 446 Wattage 621 	O	<p>Noise from under vehicle 556</p> <p>Odometer 174</p> <p>Oil</p> <ul style="list-style-type: none"> Engine oil 492 <p>Opener</p> <ul style="list-style-type: none"> Back door 54 Fuel filler door 93 Hood 486 <p>Outside rear view mirrors</p> <ul style="list-style-type: none"> Adjusting and folding 82 <p>Outside temperature display 180, 194</p>

P

- Overhead console** 438
- Overheating, Engine** 600
- Parking brake** 172
- Parking lights**
 - Replacing light bulbs 537
 - Switch 198
 - Wattage 621
- Personal lights**
 - Switch 432
 - Wattage 621
- Power back door** 54
- Power outlet** 447
- Power windows** 85

R

- Radiator** 499
- Radio** 284
- Rear seat entertainment system** 356
- Rear seats**
 - Adjustment 67
 - Folding down rear seatback ... 67
- Rear side marker lights**
 - Replacing light bulbs 537
 - Wattage 621
- Rear turn signal lights**
 - Replacing light bulbs 537
 - Wattage 621
- Rear view mirror**
 - Inside 80
 - Outside 82
 - Compass 464
- Rear view monitor system** 217
- Rear window defogger** 278
- Rear window wiper** 212
- Replacing**
 - Fuses 527
 - Key battery 523
 - Light bulbs 537
 - Tires 576
- Reporting safety defects for U.S. owners** 650

S

- Seat belts**
 - Adjusting the seat belt 73
 - Automatic Locking Retractor 74
 - Child restraint system installation 133
 - Cleaning and maintaining the seat belts 474
 - Emergency Locking Retractor 74
 - How to wear your seat belt 72
 - How your child should wear the seat belt 75
 - Pregnant women, proper seat belt use 74
 - Reminder light 563
 - Seat belt extenders 75
 - Seat belt instructions for Canadian owners 651
 - Seat belt pretensioners 73
- Seat heaters** 450
- Seating capacity** 240
- Seats**
 - Adjustment precautions 66
 - Child seats/child restraint system installation 133
 - Cleaning 473
 - Front seat adjustment 64
 - Head restraint 70
 - Properly sitting in the seat 105
 - Rear seat adjustment 67
 - Seat heaters 450
- Service reminder indicators** 177
- Shift lever**
 - Automatic transmission 166
 - If the shift lever cannot be shifted from P 590
- Shift lock system** 590
- Shopping bag hooks** 455
- Side airbags** 107

<p>Towing Dinghy towing 259 Emergency towing 551 Trailer towing 247 TRAC 224 Traction control 224 Trailer towing 247 Trip information display 180, 194 Trip meter 174 Turn signal lights Replacing light bulbs 537 Switch 171 Wattage 621</p> <p>U Utility vehicle precautions 230</p> <p>V Valet key 26 Vanity lights Vanity lights 446 Wattage 621 Vanity mirrors 446 Vehicle identification number 609 Vehicle stability control 224 VSC 224</p> <p>W Warning buzzers Brake system 560 Open door 563 Seat belt reminder 563 Warning lights Active Torque Control 4WD system 563 Automatic headlight leveling system 561 Anti-lock brake system 562 Brake system 560 Charging system 561</p>	<p>Electric power steering 561 Engine oil maintenance 563 Engine oil pressure 561 Low fuel level 563 Malfunction indicator lamp 561 Master warning 563 Open door 563 Seat belt reminder 563 SRS airbags 562 Tire pressure 563 Washer fluid 563 Warning messages 575 Washer Checking 505 Preparing and checking before winter 242 Switch 210 Washing and waxing 470 Weight Cargo capacity 235 Load limits 240 Weight 608 Wheels 517 Window glasses 85 Window lock switch 85 Windows Power windows 85 Rear window defogger 278 Washer 210 Windshield wiper de-icer 278 Windshield wipers 210, 472 Wireless remote control key Replacing the battery 523 Wireless remote control key 43 WMA disc 303</p>
--	---

*: Refer to the "Navigation System Owner's Manual".
675

What to do if... What to do if...

A tire punctures

P. 576 If you have a flat tire

The engine does not start

P. 97 Engine immobilizer system

P. 587 If the engine will not start

P. 595 If the battery is discharged

The shift lever cannot be moved out

P. 590 If the shift lever cannot be shifted from "P"

The engine coolant temperature gauge enters the red zone

P. 600 If your vehicle overheats

Steam can be seen coming from under the hood

The key is lost

P. 591 If you lose your keys

The battery runs out

P. 595 If the battery is discharged

The doors cannot be locked

P. 48 Side doors

P. 54 Back door

The horn begins to sound

P. 100 Alarm

The vehicle is stuck in mud or sand

P. 603 If the vehicle becomes stuck

What to do if...

The warning light or indicator light comes on

P. 560

If the warning light turns on or a warning buzzer sounds...

► Instrument cluster

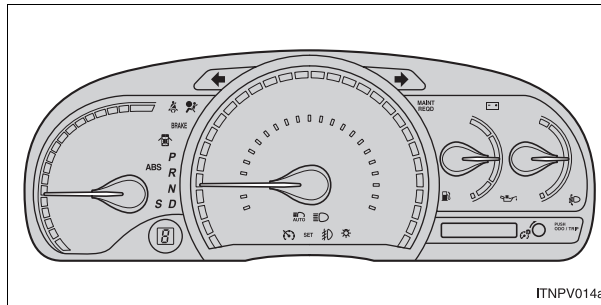



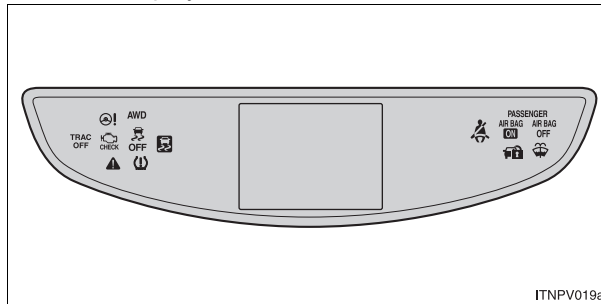











► Center display



What to do if...

n Warning lights

	Master warning light P. 563		Open door warning light P. 563
	Low engine oil pressure warning light P. 561		Tire pressure warning light P. 563
	Charging system warning light P. 561	MAINT REQD	Engine oil replacement reminder light P. 563
	Malfunction indicator lamp P. 561		Driver's seat belt reminder light P. 563
BRAKE	Brake system warning light		Front passenger's seat belt reminder light P. 563
or			Low fuel level warning light P. 563
	Automatic headlight leveling system warning light P. 561		Electric power steering system warning light P. 561
	SRS warning light P. 562		Low windshield washer fluid level warning light P. 563
ABS	ABS warning light		Smart key system warning light P. 566
or		AWD	Active Torque Control 4WD system warning light P. 563
	P. 562		

The warning message is displayed

P. 575 If a warning message is displayed

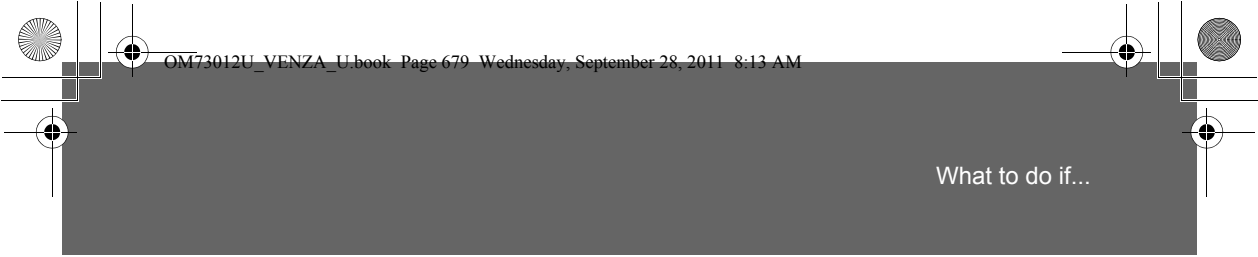

What to do if...

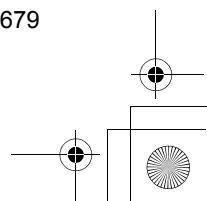
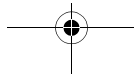
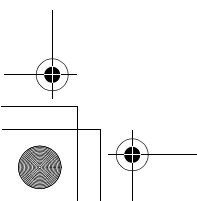
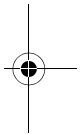
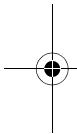

GAS STATION INFORMATION

Auxiliary catch lever
P. 486

Fuel filler door
P. 93

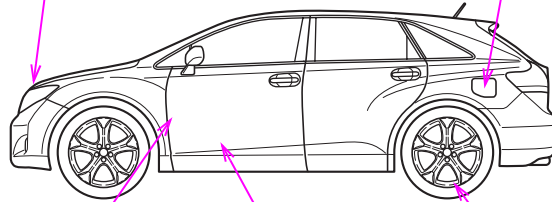

ITNPV015

Hood lock release lever
P. 486

Fuel filler door opener
P. 93

Tire inflation pressure
P. 619

Fuel tank capacity (Reference)	17.7 gal. (67 L, 14.7 Imp.gal.)	
Fuel type	Unleaded gasoline only	P. 94, 611
Cold tire inflation pressure	P. 619	
Engine oil capacity (Drain and refill — reference)	qt. (L, Imp.qt.)	
	With filter	2GR-FE engine 6.4 (6.1, 5.4) 1AR-FE engine 4.7 (4.4, 3.9)
	Without filter	2GR-FE engine 6.0 (5.7, 5.0) 1AR-FE engine 4.2 (4.0, 3.5)
Engine oil type	"Toyota Genuine Motor Oil" or equivalent Oil grade: ILSAC multigrade engine oil Recommended oil viscosity P. 612 2GR-FE engine: SAE 5W-30 1AR-FE engine: SAE 5W-20 or 0W-20	