

Video Cassette Recorder

Operating Instructions



***SLV-ED33ME/MJ/SG
SLV-ED25PS/TH
SLV-ED15PS***

WARNING

To prevent fire or shock hazard, do not expose the unit to rain or moisture.

To avoid electrical shock, do not open the cabinet. Refer servicing to qualified personnel only.

The mains lead must only be changed at a qualified service shop.

Precautions

Safety

- This unit operates on 110 – 240 V AC, 50/60 Hz. Check that the unit's operating voltage is identical with your local power supply.
- If anything falls into the cabinet, unplug the unit and have it checked by qualified personnel before operating it any further.
- The unit is not disconnected from the mains as long as it is connected to the mains, even if the unit itself has been turned off.
- Unplug the unit from the mains if you do not intend to use it for an extended period of time. To disconnect the lead, pull it out by the plug, never by the lead.

Installing

- Allow adequate air circulation to prevent internal heat buildup.
- Do not place the unit on surfaces (rugs, blankets, etc.) or near materials (curtains, draperies) that may block the ventilation slots.
- Do not install the unit near heat sources such as radiators or air ducts, or in a place subject to direct sunlight, excessive dust, mechanical vibration or shock.
- Do not install the unit in an inclined position. It is designed to be operated in a horizontal position only.
- Keep the unit and cassettes away from equipment with strong magnets, such as microwave ovens or large loudspeakers.
- Do not place heavy objects on the unit.
- If the unit is brought directly from a cold to a warm location, moisture may condense inside the VCR and cause damage to the video head and tape. When you first install the unit, or when you move it from a cold to a warm location, wait for about four hours before operating the unit.

Caution

Television programmes, films, video tapes and other materials may be copyrighted.

Unauthorized recording of such material may be contrary to the provisions of the copyright laws. Also, use of this recorder with cable television transmission may require authorization from the cable television transmitter and/or programme owner.

Compatible colour/TV systems

- This VCR is designed to record and play back using the PAL (B/G, D/K and I), MESECAM (B/G and D/K) and NTSC colour systems. Recording of video sources based on other colour systems cannot be guaranteed.
- NTSC colour signals can only be recorded through the line input.

Table of contents

Getting Started

- 4 Step 1: Unpacking
- 5 Step 2: Setting up the remote commander
- 6 Step 3: Connecting the VCR
- 7 Step 4: Tuning your TV to the VCR
- 9 Step 5: Selecting a language
- 10 Step 6: Presetting channels
- 16 Step 7: Setting the clock

Basic Operations

- 18 Playing a tape
- 22 Recording TV programmes
- 25 Recording TV programmes using the Easy Timer function
- 31 Setting the timer manually

Additional Operations

- 33 Playing/searching at various speeds
- 34 Setting the recording duration time
- 35 Checking/changing/cancelling timer settings
- 37 Searching the beginning of an Easy Timer recorded programme
- 38 Searching using the index function
- 40 Searching using the Time Search function
- 41 Adjusting the picture
- 43 Changing menu options
- 44 Editing with another VCR

Additional Information

- 46 Troubleshooting
- 49 Specifications
- 50 Index to parts and controls
- Back cover
- Index

Step 1

Unpacking

Check that you have received the following items with the VCR:

- Remote commander

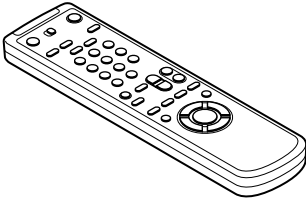

- Aerial cable

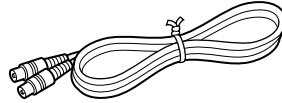

- R6 (size AA) batteries

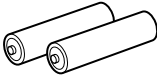

- Plug adaptor (SLV-ED33ME/MJ only)

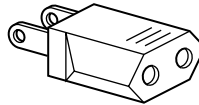

Checking your model name

The instructions in this manual are for the 6 models: SLV-ED33ME, ED33MJ, ED33SG, ED25PS, ED25TH and ED15PS. Check your model number by looking at the rear panel of your VCR. SLV-ED33ME is the model used for illustration purpose. Any difference in operation is clearly indicated in the text, for example, "SLV-ED15PS only."

Step 2

Setting up the remote commander

Inserting the batteries

Insert two R6 (size AA) batteries by matching the + and – on the batteries to the diagram inside the battery compartment.

Insert the negative (–) end first, then push in and down until the positive (+) end clicks into position.

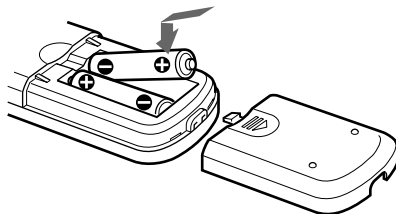

Using the remote commander

You can use this remote commander to operate this VCR and a Sony TV. Buttons marked with a dot (•) can be used to operate your Sony TV. If the TV does not have the  symbol near the remote sensor, this remote commander will not operate the TV.

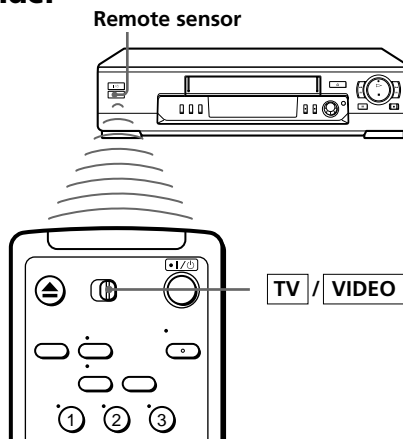

To operate	Set TV / VIDEO to
the VCR	VIDEO and point at the remote sensor on the VCR
a Sony TV	TV and point at the remote sensor on the TV

Notes

- The TV/VIDEO button selects an input source of the TV from either aerial in or line in. The button does not control this VCR.
- With normal use, the batteries should last about three to six months.
- If you do not use the remote commander for an extended period of time, remove the batteries to avoid possible damage from battery leakage.
- Do not use a new battery with an old one.
- Do not use different types of batteries.

Step 3

Connecting the VCR

Connect the aerial to your VCR and TV as shown below to watch TV programmes and VCR pictures on your TV. In addition, if your TV has audio/video (A/V) input jacks, we recommend you connect the VCR to your TV using an audio/video cable to get a better picture and sound.

Connecting the aerial

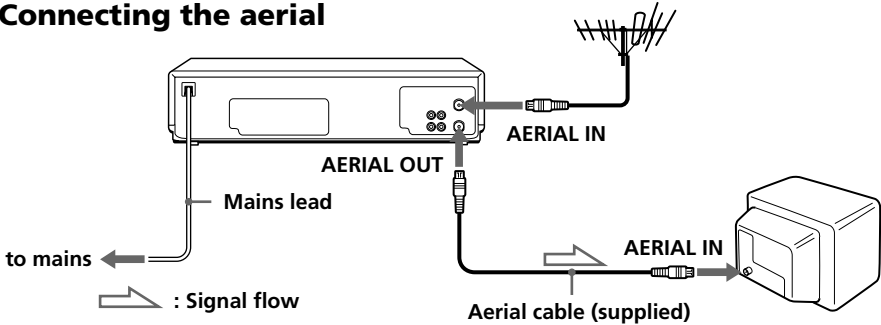

1

Disconnect the aerial cable from your TV and connect it to AERIAL IN on the rear panel of the VCR.

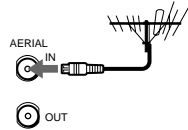

2

Connect AERIAL OUT of the VCR and the aerial input of your TV using the supplied aerial cable.

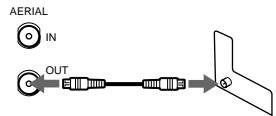

3

Connect the mains lead to the mains.

Additional connections

To a TV that has audio/video input jacks

This additional connection improves picture and sound quality. Connect the TV as shown on the right.

If you want to use the Trinitron TV Synchro Play function (see page 21), this connection is necessary. (If your TV has two or more inputs, connect the audio/video cable to the VIDEO IN 1 jacks.)

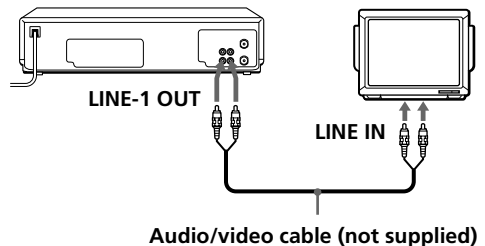

Step 4

Tuning your TV to the VCR

If you have connected your VCR to the TV using the audio/video cable, skip this step.

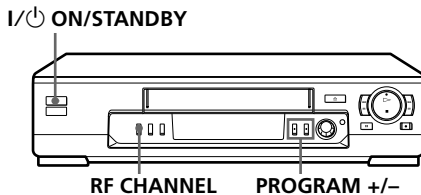

1  Press **I/ON/STANDBY** to turn on the VCR.

2  Press **RF CHANNEL** on the VCR.
The factory-preset RF channel flashes in the display window for about three seconds.
Press **RF CHANNEL** again while the RF channel is flashing.
The VCR signal is output through this channel to the TV.

e.g. SLV-ED25PS/TH and ED15PS

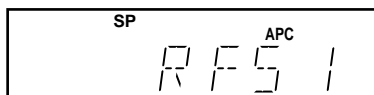

For SLV-ED33ME/MJ/SG: The factory-preset RF channel is "RF 32"

3 Turn on your TV and select a programme position for the VCR picture. This channel will now be referred to as the video channel.
Some TV has the programme position, such as 0, that is reserved for a VCR. In this case, select that programme position for the VCR picture. Refer to the instruction manual of your TV for details.

4  Press **RF CHANNEL**.
The TV system indicator appears in the display window.
Press **PROGRAM +/-** to select the correct TV system.

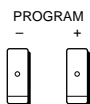

If your TV system is	Select
B/G	G
I	I
D/K	K

continued

Step 4: Tuning your TV to the VCR (continued)

e.g. SLV-ED25PS/TH
and ED15PS

Selected TV
system

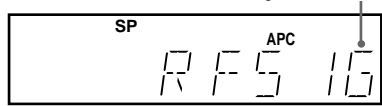

5

Tune the TV to the same channel as that shown in the display window so that the picture on the right appears on the TV screen.

Refer to your TV manual for tuning instructions.

If the picture does not appear clearly, see "To obtain a clear picture from the VCR" below.

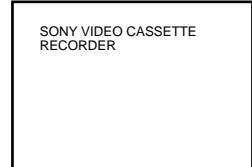

6



Press RF CHANNEL.

You have now tuned your TV to the VCR. From now on, whenever you want to play a tape, set the TV to the video channel.

To obtain a clear picture from the VCR

If the picture does not appear clearly in step 5 above, go to step 6 to finish this procedure once. Then start from step 2. After pressing RF CHANNEL twice in step 2 to display the RF channel, press PROGRAM +/- so that another RF channel appears. Then tune the TV to the new RF channel until a clear picture appears.

To set another RF channel number on the VCR, select a channel number that does not receive a broadcast signal in your area and is clear of interference from other channels.

If you cannot obtain a clear picture after performing this procedure, we recommend you connect the VCR and TV using the audio/video cable (see "To a TV that has audio/video input jacks" on page 6). If the same symptom persists, consult your nearest Sony dealer.

Note

- If you set the wrong TV system, you may have no sound or sound may be distorted (noisy sound).

Step 5

Selecting a language

You can change the on-screen display language from English to Arabic.

Before you start...

- Turn on your TV and set it to the video channel.

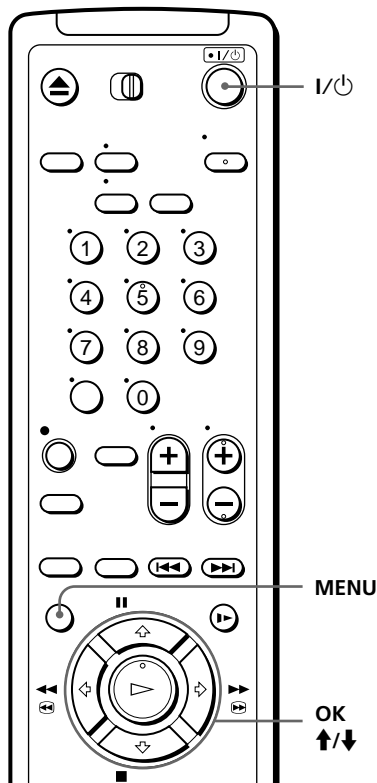

1  Press I/⏻ (on/standby) to turn on the VCR.

2  Press MENU, then press **⬆️/⬇️** to move the cursor (**▶**) to LANGUAGE and press OK.

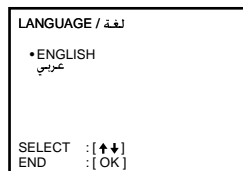

3  Press **⬆️/⬇️** to select the desired language, then press OK.

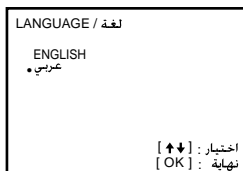

Step 6

Presetting channels

First, we recommend that you preset the receivable channels in your area using the One Touch Tuning function or the AUTO PRESET in the TUNER PRESET menu. Then, if some channels could not be preset automatically, set them manually; if there are any unwanted channels among the preset ones, you can disable the channels.

Presetting all receivable channels using the One Touch Tuning function

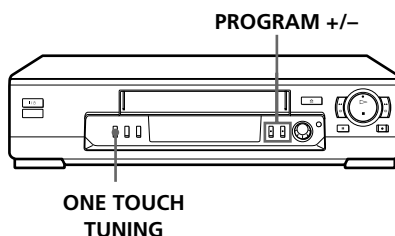

ONE TOUCH
TUNING



Press and hold ONE TOUCH TUNING on the VCR for more than three seconds.

The VCR starts presetting the channels.

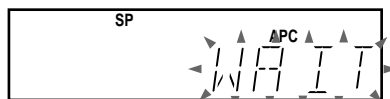

The WAIT indicator goes off when all receivable channels are preset.

To check if the channels are preset correctly

Set the TV to the video channel and press PROGRAM +/- on the VCR. If the TV screen changes to a different programme each time you press PROGRAM +/-, the channels are preset correctly.

If the sound is distorted or noisy, the VCR is set to a TV system different from your area's. Select the correct TV system and preset channels using the TUNER PRESET menu as shown on the next page.

Tip

- To stop the One Touch Tuning function, press ONE TOUCH TUNING or ■ STOP on the VCR during the setting.

Presetting all receivable channels automatically

Before you start...

- Turn on the VCR and the TV.
- Set the TV to the video channel.

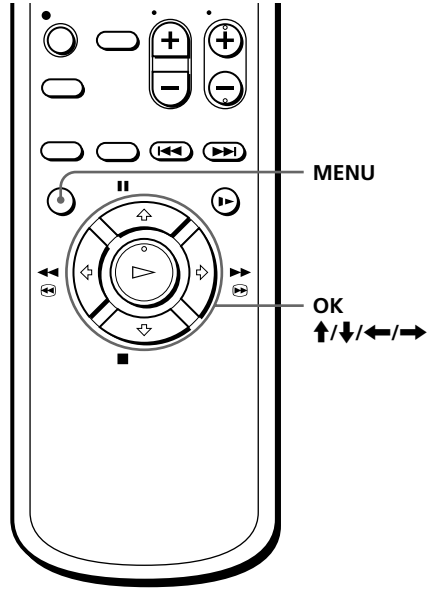

1



Press MENU, then press \uparrow/\downarrow to move the cursor (\blacktriangleright) to TUNER PRESET and press OK.

TUNER PRESET	PROG 1
SYSTEM	*B/G D/K I
NORMAL / CATV	•NORM CATV
AUTO PRESET	
▶CHANNEL SET	1
AFT	•ON OFF
FINE TUNING	
SELECT	:[\uparrow/\downarrow]
SET	:[\leftarrow/\rightarrow]

2



Press $\uparrow/\downarrow/\leftarrow/\rightarrow$ to move the cursor (\blacktriangleright) to SYSTEM, then select B/G, D/K or I, whichever is applicable in your area. If SYSTEM is set to the wrong position, the sound will be distorted or noisy.

TUNER PRESET	PROG 1
▶SYSTEM	*B/G D/K I
NORMAL / CATV	•NORM CATV
AUTO PRESET	
CHANNEL SET	1
AFT	•ON OFF
FINE TUNING	
SELECT	:[\uparrow/\downarrow]
SET	:[\leftarrow/\rightarrow]

3



Press $\uparrow/\downarrow/\leftarrow/\rightarrow$ to move the cursor (\blacktriangleright) to NORMAL / CATV, then select NORM.

To preset CATV channels, select CATV.

TUNER PRESET	PROG 1
SYSTEM	*B/G D/K I
▶NORMAL / CATV	•NORM CATV
AUTO PRESET	
CHANNEL SET	1
AFT	•ON OFF
FINE TUNING	
SELECT	:[\uparrow/\downarrow]
SET	:[\leftarrow/\rightarrow]

continued

Step 6: Presetting channels (continued)

4



Press **↑/↓** to move the cursor (▶) to **AUTO PRESET**, then press **OK**.

All receivable channels are preset in numerical sequence. When no more receivable channels can be found, presetting stops and the picture from the lowest numbered channel is displayed on the TV screen.

TUNER PRESET		PROG 1	
SYSTEM	•B/G	D/K	I
NORMAL / CATV	•NORM	CATV	
▶AUTO PRESET			
CHANNEL SET		1	
AFT	•ON	OFF	
FINE TUNING			
PLEASE WAIT			

Presetting channels manually

Before you start...

- Turn on the VCR and the TV.
- Set the TV to the video channel.

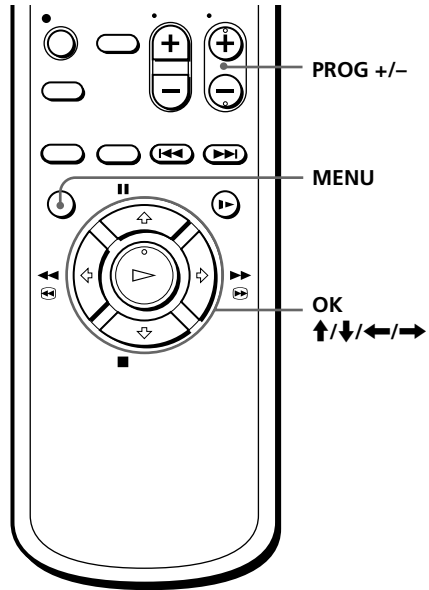

1

MENU



Press MENU, then press **↑/↓** to move the cursor (▶) to TUNER PRESET and press OK.

TUNER PRESET	PROG10
SYSTEM	•B/G D/K I
NORMAL / CATV	•NORM CATV
AUTO PRESET	
▶CHANNEL SET	21
AFT	•ON OFF
FINE TUNING	
SELECT	: [↑↓]
SET	: [←→]

2



Press **↑/↓/←/→** to move the cursor (▶) to NORMAL / CATV, then select NORM.
To preset CATV channels, select CATV.

TUNER PRESET	PROG10
SYSTEM	•B/G D/K I
NORMAL / CATV	•NORM CATV
AUTO PRESET	
▶CHANNEL SET	21
AFT	•ON OFF
FINE TUNING	
SELECT	: [↑↓]
SET	: [←→]

3



Press **↑/↓** to move the cursor (▶) to CHANNEL SET.

TUNER PRESET	PROG10
SYSTEM	•B/G D/K I
NORMAL / CATV	•NORM CATV
AUTO PRESET	
▶CHANNEL SET	21
AFT	•ON OFF
FINE TUNING	
SELECT	: [↑↓]
SET	: [←→]

continued

Step 6: Presetting channels (continued)

4



Press PROG +/- to select the programme position.

Selected programme position

TUNER PRESET	PROG13
SYSTEM	•B/G D/K I
NORMAL / CATV	•NORM CATV
AUTO PRESET	
▶CHANNEL SET	21
AFT	•ON OFF
FINE TUNING	
SELECT	: [↑↓]
SET	: [←→]

5



Press → repeatedly until the channel you want is displayed.
Pressing ← goes back to the previous channels.

The channels are scanned in the following order:

TUNER PRESET	PROG14
SYSTEM	•B/G D/K I
NORMAL / CATV	•NORM CATV
AUTO PRESET	
▶CHANNEL SET	35
AFT	•ON OFF
FINE TUNING	
SELECT	: [↑↓]
SET	: [←→]

Channel coverage	System B/G	System D/K	System I
VHF	E2–E12	R1–R12	SA4–SA13
UHF	E21–E69	R21–R69	B21–B69
CATV (TV distribution)	S1–S41, S01–S05	–	S1–S41, S01–S05

If you know the number of the channel you want, press the programme number buttons. For example, for channel 5, first press "0" and then press "5."

6



If the TV sound is distorted or noisy, press ↑/↓/←/→ to move the cursor (▶) to SYSTEM, then select B/G, D/K or I whichever is applicable in your area.

TUNER PRESET	PROG14
▶SYSTEM	•B/G D/K I
NORMAL / CATV	•NORM CATV
AUTO PRESET	
CHANNEL SET	35
AFT	•ON OFF
FINE TUNING	
SELECT	: [↑↓]
SET	: [←→]

7

To allocate another channel to another programme position, repeat steps 4 and 5.

8



Press OK.

Disabling unwanted programme positions

After presetting channels, you can disable unused programme positions. The disabled positions will be skipped later when you press the PROG +/- buttons.

- 1 In step 5 on page 14, press programme number button "0" twice to display the number "0" beside CHANNEL SET.
- 2 Press OK.

If the picture is not clear

Normally, the Auto Fine Tuning (AFT) function automatically tunes in channels clearly. If, however, the picture is not clear, you may also use the manual tuning function.

- 1 Press PROG +/- to select the programme number for which you cannot obtain a clear picture.
- 2 Press MENU, then select TUNER PRESET and press OK.
- 3 Select FINE TUNING.

The fine tuning meter appears.

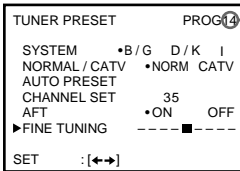

Selected programme position

- 4 Press ←/→ to get a clearer picture, then press OK.

Note that the AFT (Auto Fine Tuning) setting switches to OFF.

Note

- The menu disappears automatically if you do not proceed for more than a few minutes.

Step 7

Setting the clock

You must set the time and date on the VCR to be able to use the timer recording features properly.

Before you start...

- Turn on the VCR and the TV.
- Set the TV to the video channel.

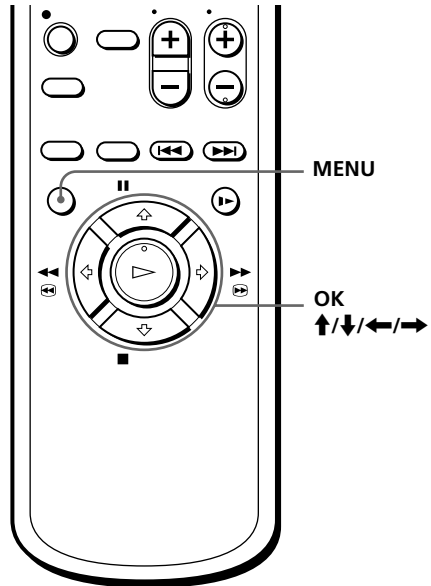

1



Press MENU, then press \uparrow/\downarrow to move the cursor (\blacktriangleright) to CLOCK SET and press OK.

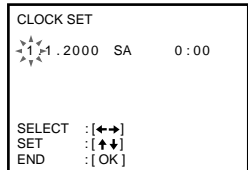

2



Press \uparrow/\downarrow to set the date.
The day of the week is set automatically.

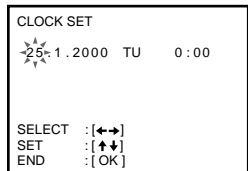

3



Press \rightarrow to flash the month and set the month using \uparrow/\downarrow .

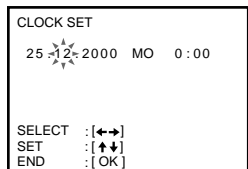

4



Set the year, hour and minute in sequence, using **→** to flash the item to be set, and **↑/↓** to select the digits.

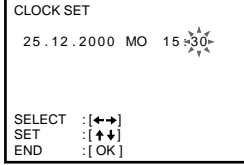

5



Press OK to start the clock.

Tip

- To change the digits during setting, press **←** to return to the item to be changed, and select the digits using **↑/↓**.

Note

- The menu disappears automatically if you do not proceed for more than a few minutes.

Playing a tape

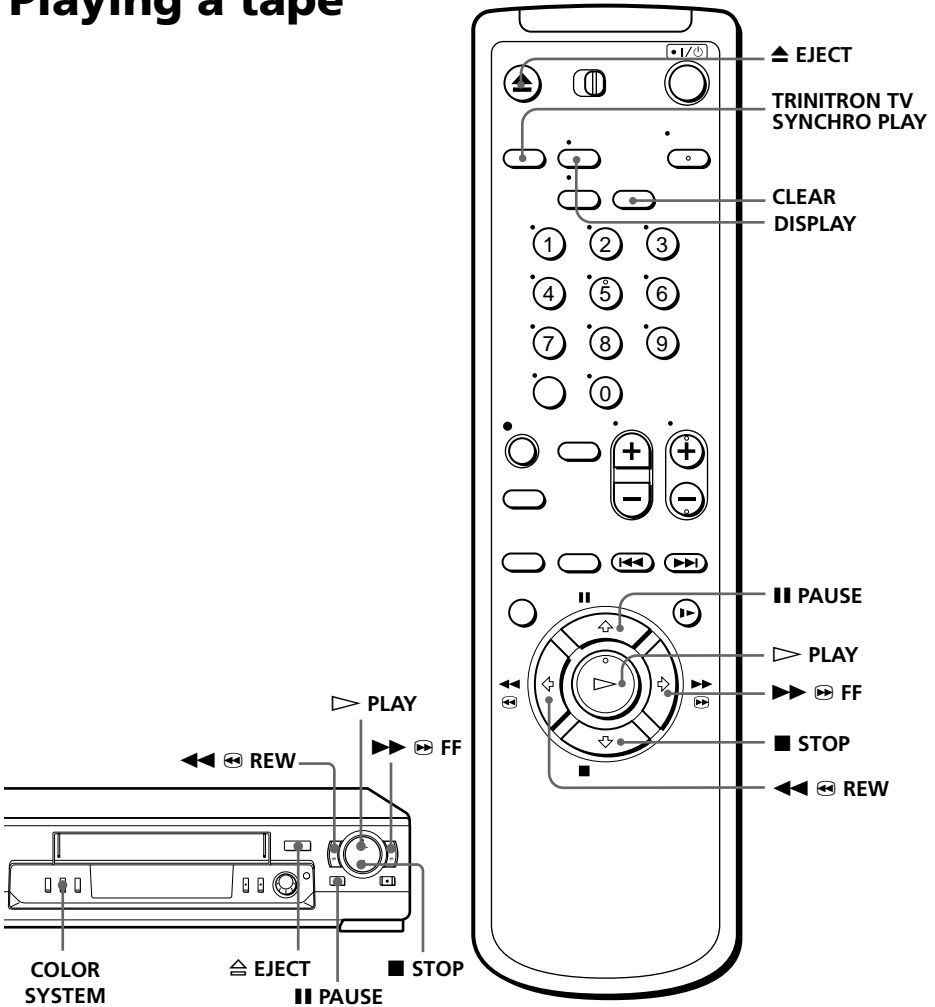

1

Turn on your TV and set it to the video channel.

2

Insert a tape.

The VCR turns on and starts playing automatically if you insert a tape with its safety tab removed.

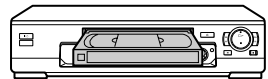

3

Press \triangleright PLAY.

When the tape reaches the end, it will rewind automatically.

Additional tasks

To	Press
Stop play	■ STOP
Pause play	PAUSE
Resume play after pause	PAUSE or \triangleright PLAY
Fast-forward the tape	$\blacktriangleright\blacktriangleright$ FF during stop
Rewind the tape	$\blacktriangleleft\blacktriangleleft$ REW during stop
Eject the tape	\blacktriangleup EJECT

To set the colour system

If streaks appear during playback, press COLOR SYSTEM on the VCR to conform to the system that the tape was recorded in. (Normally, the colour system is correctly set whenever the tape is inserted.)

If your tape was recorded in	Press COLOR SYSTEM until the indication below appears in the display window.
PAL	PAL
MESECAM	PAL
NTSC	NTSC

To play an NTSC-recorded tape

Set NTSC PB in the SET UP MENU according to the colour system of your TV. For details, see page 43.

If your TV is	Set NTSC PB to
PAL	ON PAL TV
NTSC 4.43	4.43
NTSC 3.58	3.58

continued

Playing a tape (continued)

To use the time counter

At the point on the tape that you want to find later, press CLEAR. The counter in the display window resets to "0:00:00." Search for the point afterwards by referring to the counter.

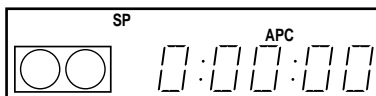

To display the counter on the TV screen, press DISPLAY.

Notes

- When you play back a tape recorded in the PAL or MESECAM colour system, streaks may appear even if the colour system setting is set to AUTO. If so, select the colour system, PAL or MESECAM in the PAL/MESECAM option of the SET UP MENU (see page 43 for details).
- The counter resets to "0:00:00" whenever a tape is reinserted.
- The counter stops counting when it comes to a portion with no recording.
- If a tape has portions recorded in both PAL and NTSC systems, the time counter reading will not be correct. This is due to the difference between the counting cycles of the two colour systems.
- Depending on your TV, the following may occur while playing an NTSC-recorded tape:
 - the picture is black and white
 - the picture shakes
 - no picture appears on the TV screen
 - black streaks appear horizontally on the TV screen
 - the colour density increases or decreases.
- Tapes recorded in the LP mode of NTSC system on other VCRs can be played back on this VCR, but the picture quality cannot be guaranteed.
- While setting the menu on the TV screen, you cannot use the ▷ PLAY, || PAUSE, ►► FF, ◀◀ REW or ■ STOP button. These buttons are used for menu operations.

Turning on the VCR and TV, and starting playback automatically (Trinitron TV Synchro Play)

You can only use this function if your TV is made by Sony (Trinitron TV).

How to connect to use this function

Connect the VCR and TV with the audio/video cable (see “To a TV that has audio/video input jacks” on page 6). Be sure to connect the audio/video cable to the VIDEO IN 1 jacks on the TV if the TV has two inputs or more. The TV must be placed where it will respond to the remote commander while you are pointing it at the VCR.

Operation

Make sure that the TV's main power is on.

Press TRINITRON TV SYNCHRO PLAY and hold the remote commander in place for about two seconds.

The VCR and TV turn on, and the TV is set to VCR reception. If there is a tape in the VCR, playback starts automatically.

Notes

- If the Trinitron TV Synchro Play function does not work properly:
 - Wait a few moments, and press the button again.
 - Replace both of the batteries with new ones, and press the button again.Note that this function may not operate some Sony TVs because of the remote commander's signal limitations.
- Do not press TRINITRON TV SYNCHRO PLAY while playing back a video tape. If you do so, the TV's input source will momentarily switch to the TV's tuner.

Recording TV programmes

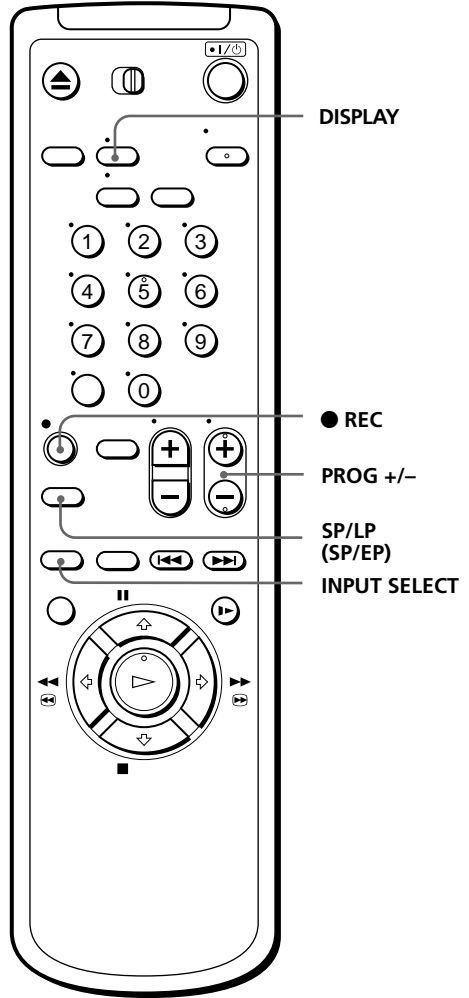

- 1** Turn on your TV and set it to the video channel.
- 2** Insert a tape with its safety tab in place.
- 3** Press **PROG +/-** to select the programme position you want to record.

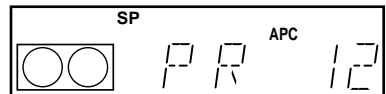

4



Press SP/LP (SP/EP) to select the tape speed, SP or LP.

LP (Long Play) provides recording time twice as long as SP (Standard Play), however, SP produces better picture and audio quality.

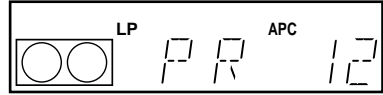

5



Press ● REC to start recording.

The recording indicator lights up red in the display window.

Recording indicator



To stop recording

Press ■ STOP.

To check the remaining tape length

Press DISPLAY. The white bar indicates the approximate length of tape remaining.

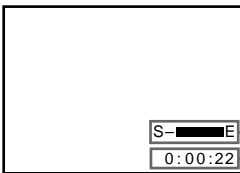

S — E — Remaining tape length
0:00:22 — Time counter

To watch another TV programme while recording

- 1 If the TV is connected to the VCR using an audio/video cable, set the TV to TV input. If the TV is connected to the VCR using only the aerial cable, skip this step.
- 2 Select another programme position on the TV.

To save a recording

To prevent accidental erasure, break off the safety tab as illustrated. To record on the tape again, cover the tab hole with adhesive tape.

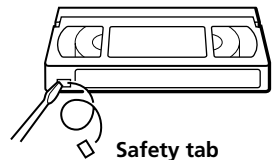

Safety tab

continued

Recording TV programmes (continued)

To record NTSC colour system programmes

NTSC colour signals can be recorded through the line input (LINE-1 IN) only. Display "L" in the display window using INPUT SELECT or PROG +/- in step 3.

For tape speed, select SP or EP in step 4.

EP provides recording time three times as long as SP, however, SP produces better picture and sound quality.

When playing back, the VCR automatically detects the tape speed.

Tips

- To select a programme position, you can use the programme number buttons on the remote commander. For two-digit numbers, press the -- (ten's digit) button followed by the programme number buttons.
- You can select a video source from the LINE-1 IN jacks. Press INPUT SELECT or PROG +/- to display "L" in the display window.
- The display appears on the TV screen indicating information about the tape, but the information will not be recorded on the tape.
- If you do not want to watch TV while recording, you can turn off the TV.

Notes

- The display does not appear during still (pause) mode or slow-motion playback.
- It may take up to one minute for the VCR to calculate and display the remaining tape length after you press DISPLAY.
- The remaining tape length does not appear while playing or recording in NTSC system.

Recording TV programmes using the Easy Timer function

The Easy Timer function allows you to make a timer recording of a programme without turning on your TV. Set the recording timer to record only one programme that will be broadcast within the next 24 hours using the EASY TIMER knob. If the VCR clock has not been set, you can also set the clock before setting the timer recording.

Setting the Easy Timer

Before you start...

- Insert a tape with its safety tab in place. Make sure the tape is longer than the recording time.

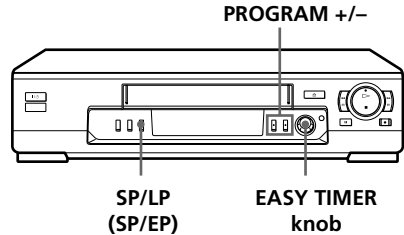

Press the EASY TIMER knob.

The START indicator appears in the display window.

If the clock has not been set, “-:-” appears. Go to step 2 in “Setting or changing the Easy Clock” on page 27.

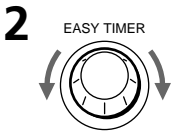
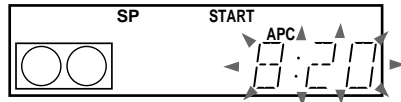

Set the recording start time by turning the EASY TIMER knob clockwise or counterclockwise to increase or decrease the time by 15 minutes.

To increase or decrease the time by one minute, press PROGRAM +/-.

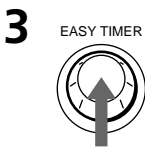
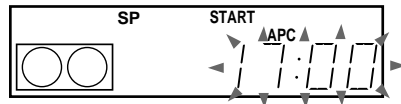

Press the EASY TIMER knob to confirm the start time setting.

The STOP indicator appears.

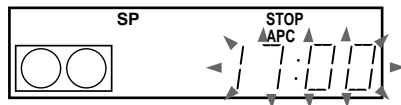

continued

Recording TV programmes using the Easy Timer function (continued)

4



Set the recording stop time in the same way as in step 2, then press the EASY TIMER knob.

A programme number flashes.

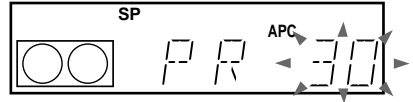

5



Turn the EASY TIMER knob clockwise or counterclockwise to select the programme you want to record.

To select the tape speed, press SP/LP (SP/EP).

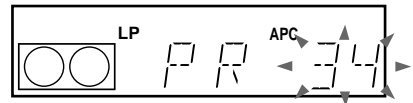

6



Press the EASY TIMER knob to confirm the setting.

The  indicator appears in the display window and the VCR stands by for recording.



Setting or changing the Easy Clock

When “-:-” is displayed in the display window, the VCR clock has not been set. You need to set the clock using the Easy Clock function before setting the timer. You can also change the current time using the Easy Clock function.

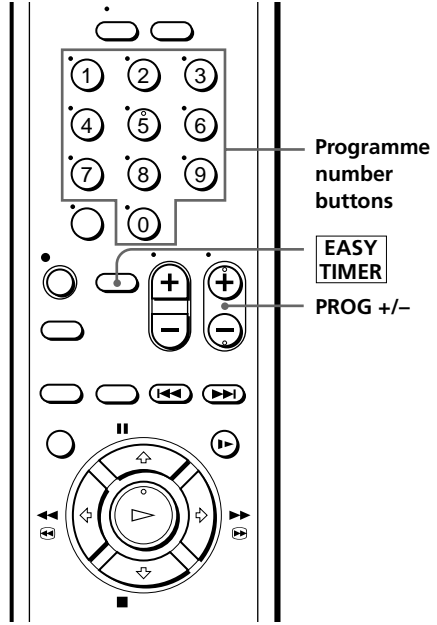
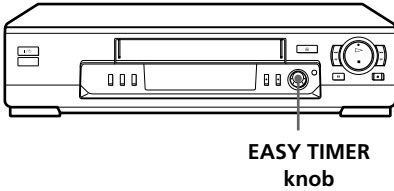

- When “-:-” is displayed in the display window, press EASY TIMER.
- To change the clock setting, press and hold the EASY TIMER knob on the VCR for more than three seconds.

The CLOCK indicator and the current clock setting appear in the display window.

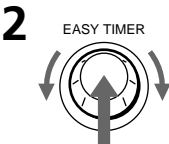
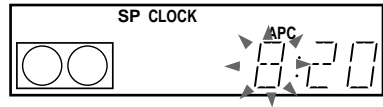

Set the current time using the EASY TIMER knob.

- 1** Turn the EASY TIMER knob clockwise or counterclockwise to enter the current hour.
- 2** Press the EASY TIMER knob to confirm the hour setting.
- 3** Turn the EASY TIMER knob to increase or decrease the minutes setting by a minute.

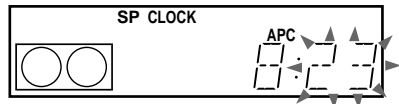

continued

Recording TV programmes using the Easy Timer function (continued)

3

EASY TIMER



Press the EASY TIMER knob to confirm the clock setting.

The VCR enters the timer recording setting mode.

To continue the Easy Timer setting, go to step 2 in “Setting the Easy Timer” on page 25.

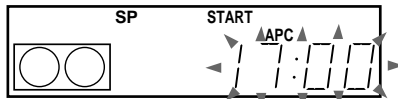

To quit the Easy Timer setting mode without changing any settings, press the EASY TIMER knob repeatedly until the ☺ indicator appears in the display window.

To set the timer and clock setting using the remote commander

You can also use the remote commander to set the Easy Timer and Easy Clock. The operations on the VCR and the remote commander correspond as follows:

To	Do this on the VCR	Do this on the remote commander
Confirm the setting and go to the next setting	Press EASY TIMER knob	Press EASY TIMER
Change the time by 15 minutes (in START/STOP mode)	Turn EASY TIMER knob or hold PROGRAM +/- down	Hold PROG +/- down
Change the time by one minute (in START/STOP mode)	Press PROGRAM +/-	Press PROG +/-
Select the programme	Turn EASY TIMER knob or press PROGRAM +/-	Press PROG +/- or INPUT SELECT
Change the hour/minute by one hour/minute (in CLOCK mode)	Turn EASY TIMER knob or press PROGRAM +/-	Press PROG +/-

You can also use the programme number buttons to set the clock, start and stop times, and the programme you want to record. Just press the programme number buttons to enter the hours and minutes. For example:

- To set the clock to “8:20”, press 0, 8, **EASY TIMER**, 2, 0 and **EASY TIMER** in sequence.
- To set the start or stop time to “8:20”, press 0, 8, 2, 0 and **EASY TIMER** in sequence.

If you make a mistake, re-enter the correct digits before pressing **EASY TIMER**.

To stop recording

To stop the VCR while recording, press ■ STOP.

To check or change the timer setting

Press the EASY TIMER knob repeatedly until the setting you want to check or change flashes. Then re-enter the new setting, if necessary. If you do not want to change any of the settings, press the EASY TIMER knob repeatedly until the ☺ indicator appears in the display window.

You can also change the timer setting using the TIMER SET/CHECK menu. For details, see page 35.

To cancel the timer setting

To cancel the Easy Timer setting while doing the setting, press CLEAR on the remote commander or press PROGRAM + and – on the VCR at the same time.

To use the VCR after setting the timer

To use the VCR before a timer recording begins, just press I/⏻. The ☺ indicator turns off and the VCR switches on. Remember to press I/⏻ to reset the VCR after using the VCR.

You can also do the following tasks while the VCR is recording:

- Reset the counter.
- Display tape information on the TV screen.
- Check the timer settings.
- Watch another TV programme.

To watch the recorded programme right after the Easy Timer recording

The SEARCH indicator starts flashing when the VCR finishes the Easy Timer recording. To watch the recorded programme, press the EASY TIMER knob. The VCR turns on, starts searching, then automatically starts playback from the beginning of the recording. For details, see page 37.

continued

Recording TV programmes using the Easy Timer function (continued)

Tips

- To record from a source connected to LINE-1 IN jacks, press INPUT SELECT or PROG +/- or turn the EASY TIMER knob to display "L" in the display window.
- To record NTSC signals, set the tape speed to SP or EP. To set to the EP mode, display "LP" in the display window.

Notes

- You cannot set the Easy Timer if eight programmes have already been set.
- You can set the timer for only one programme using the Easy Timer function. If you want to set the timer for other programmes, use the TIMER SET/CHECK menu. For details, see page 31.
- You cannot set the date using the Easy Timer function. Set the date using the CLOCK SET menu if you want to set the timer with the menu. For details, see page 16.
- The (⌚) indicator flashes in the display window when you complete the setting with no tape inserted.

Setting the timer manually

You can preset up to eight programmes at a time.

Before you start...

- Check that the VCR clock is set to the correct time.
- Insert a tape with its safety tab in place. Make sure the tape is longer than the total recording time.
- Turn on your TV and set it to the video channel.

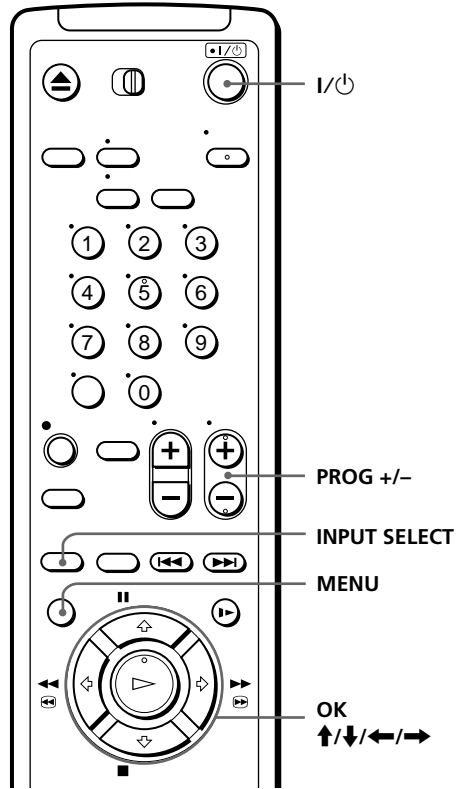

1

MENU



Press MENU and select TIMER SET / CHECK, then press OK.



TIMER SET / CHECK	DATE	START	STOP	PROG
▶---	---	---	---	---
---	---	---	---	---
---	---	---	---	---
---	---	---	---	---
---	---	---	---	---
---	---	---	---	---
---	---	---	---	---

2



Set the date, start and stop times, programme position, and tape speed:

1 Press → to flash each item in turn.

2 Press ↑/↓ to set each item.

To correct a setting, press ← to return to that setting and reset.

TIMER SET / CHECK	DATE	START	STOP	PROG
▼25.12MO	---	---	---	---
---	---	---	---	---
---	---	---	---	---
---	---	---	---	---
---	---	---	---	---
---	---	---	---	---
---	---	---	---	---
---	---	---	---	---

continued

Setting the timer manually (continued)

To record the same programme every day or the same day every week, press **↓** while the date is flashing. For details, see "Daily/weekly recording" below.

To record from a source connected to the LINE-1 IN jacks; press INPUT SELECT or PROG +/- to display "L" in the "PROG" position.

3



Press **→** to confirm the setting.

The cursor (**▶**) appears at the beginning of the line. To enter another setting, move the cursor to the next line and repeat step 2.

4



Press OK.

5



Press I/⏻ to turn off the VCR.

The ⏻ indicator appears in the display window and the VCR stands by for recording.

To record from other equipment, leave the connected equipment switched on.

To stop recording

To stop the VCR while recording, press **■** STOP.

Daily/weekly recording

In step 2 above, press **↓** to select the recording pattern. Each time you press **↓**, the indication changes as shown below. Press **↑** to change the indication in reverse order.

the current date → SU-SA (Sunday to Saturday) → MO-SA (Monday to Saturday) → MO-FR (Monday to Friday) → EVERY SA → EVERY MO → EVERY SU → 1 month later → (dates count down) → the current date

Tips

- To set the programme position, you can also use the PROG +/- or programme number buttons.
- To set the tape speed, you can also use the SP/LP (SP/EP) button.
- To record NTSC signals, set the tape speed to SP or EP. To set to the EP mode, display "LP" in the tape speed position.

Note

- The ⏻ indicator flashes in the display window when you press I/⏻ with no tape inserted.

Playing/searching at various speeds

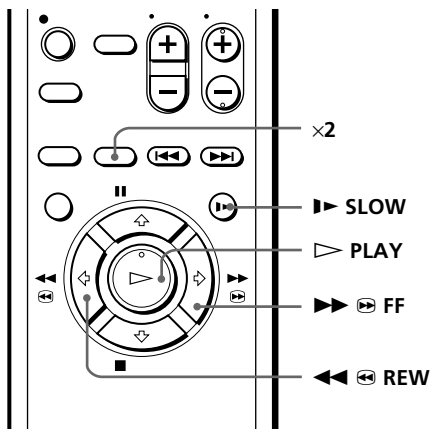
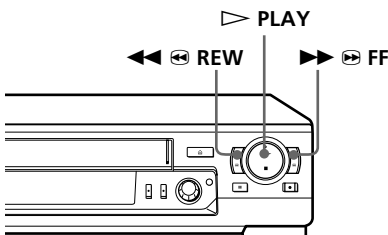

Playback options	Operation
View the picture during fast-forward or rewind	During fast-forward, hold ►► ►► FF down. During rewind, hold ◀◀ ◀◀ REW down.
Play at high speed	<ul style="list-style-type: none"> • During playback, press ►► ►► FF or ◀◀ ◀◀ REW on the remote commander. • During playback, hold ►► ►► FF or ◀◀ ◀◀ REW down. When you release the button, normal playback resumes.
Play at twice the normal speed	During playback or pause, press x2.
Play in slow motion	During playback or pause, press ►► SLOW.
Play frame by frame	During pause, press ►► ►► FF or ◀◀ ◀◀ REW on the remote commander. Hold the button down to play one frame each second.
Rewind and start play	During stop, press ►► PLAY on the VCR while holding ◀◀ ◀◀ REW down on the VCR.

To resume normal playback

Press ►► PLAY.

Tips

- Adjust the picture using TRACKING +/- on the VCR if:
 - streaks appear while playing in slow motion.
 - the picture shakes while pausing.
 To set tracking to the centre position, press both buttons (+/-) at the same time.
- If noise appears during pause or frame-by-frame playback, first switch to the slow motion playback, then adjust the picture using TRACKING +/- on the VCR.

Notes

- The playback sound is muted during these operations.
- In LP or EP mode, noise may appear or there may be no colour.
- The picture may have snow when playing at high speed in reverse.
- On-screen symbols may shake while playing or searching at various speeds.

Setting the recording duration time

After you have started recording in the normal way, you can have the VCR stop recording automatically after a specified duration.

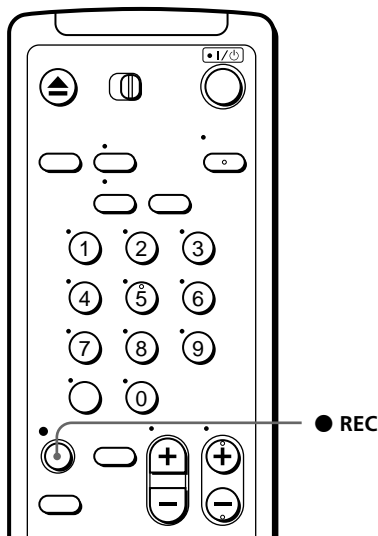

- 1 While recording, press ● REC.
The ⊖ indicator appears in the display window.

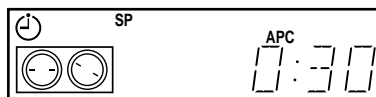

- 2 Press ● REC repeatedly to set the duration.
Each press advances the time in increments of 30 minutes.

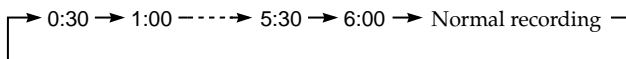

The tape counter decreases minute by minute to 0:00, then the VCR stops recording and turns off automatically.

To extend the duration

Press ● REC repeatedly to set to the new duration.

To cancel the duration

Press ● REC repeatedly until the ⊖ indicator disappears and the VCR returns to normal recording mode.

To stop recording

To stop the VCR while recording, press ■ STOP.

Checking/ changing/ cancelling timer settings

Before you start...

- Turn on your TV and set it to the video channel.

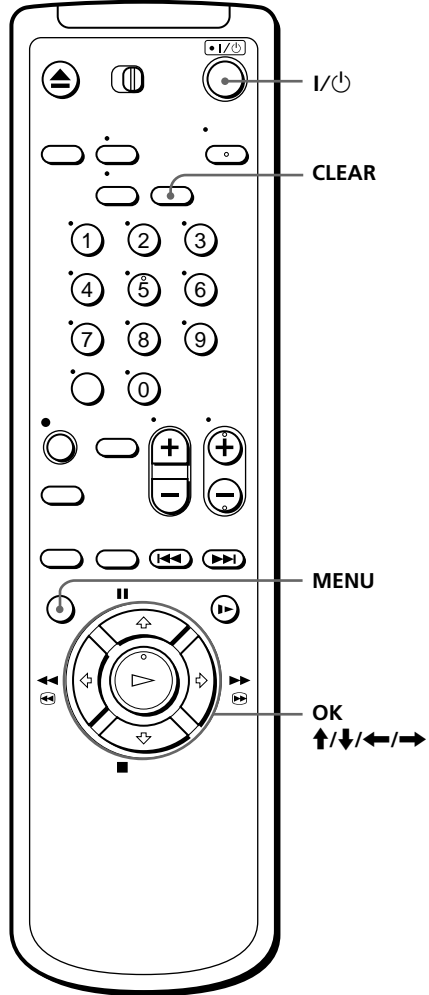

- 1 Press I/⏻ to turn on the VCR.
- 2 Press MENU, then select TIMER SET / CHECK:

- If you want to change or cancel a setting, go on to the next step.
- If you do not need to change the settings, press OK, then turn off the VCR to return to recording standby.

TIMER SET / CHECK	25 . 12 MO
DATE	START STOP PROG
▶ 6 . 1 SA	7 : 00 8 : 00 6 SP
8 . 1 MO	21 : 00 0 : 00 50 LP
MO - SA	0 : 12 13 : 00 27 LP
EVERY SU	23 : 00 0 : 00 L SP
---	---
---	---
---	---
---	---
---	---

continued

Checking/changing/cancelling timer settings (continued)

- 3** Press **↑/↓** to select the setting you want to change or cancel:
- To change the setting, press **←/→** to flash the item you want to change, and press **↑/↓** to reset it. Then, press **→** repeatedly until the cursor (**▶**) appears at the beginning of the line.
 - To cancel the setting, press **CLEAR**.
- 4** Press **OK**.
- If any timer settings remain, turn off the VCR to return to recording standby.

When the timer settings overlap

The programme that starts first has priority and the second programme starts recording only after the first programme has finished. If the programmes start at the same time, the programme listed first in the menu has priority.

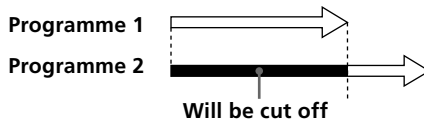

Searching the beginning of an Easy Timer recorded programme

If you record a programme using the Easy Timer function, you can easily find the beginning of the recording with this SEARCH function. The SEARCH indicator flashes when the VCR finishes the Easy Timer recording.

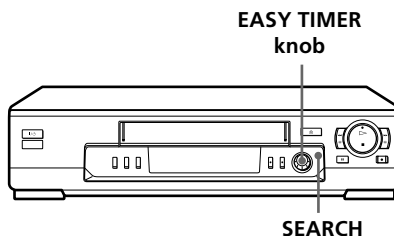

Press the EASY TIMER knob.

The VCR turns on, rewinds to the beginning of the recorded programme and starts playback automatically.

Tip

- To stop the flashing of the SEARCH indicator, first turn the VCR on, then press the SEARCH button. (Do not press any button at this point, otherwise this SEARCH mode will be cancelled.) To start the SEARCH function, press the SEARCH button once. If you press the SEARCH button repeatedly, you can enter the index search or Time Search mode.

For details, see pages 39 and 40.

Notes

- This SEARCH function will be cancelled (the SEARCH indicator turns off) if:
 - The VCR starts recording other programmes.
 - You press ▷ PLAY, ►► FF, ◀◀ REW or ⏏ EJECT button (while the VCR is on).
- With this SEARCH function, you can find the beginning of a programme recorded using the Easy Timer function only.

Searching using the index function

The VCR marks the tape with an index signal at the point where each recording begins. Use these signals as references to find a specific recording. The VCR can search up to 99 index signals ahead of or behind the current position. You can either use the INDEX SEARCH buttons on the remote commander or the SEARCH button and EASY TIMER knob on the VCR.

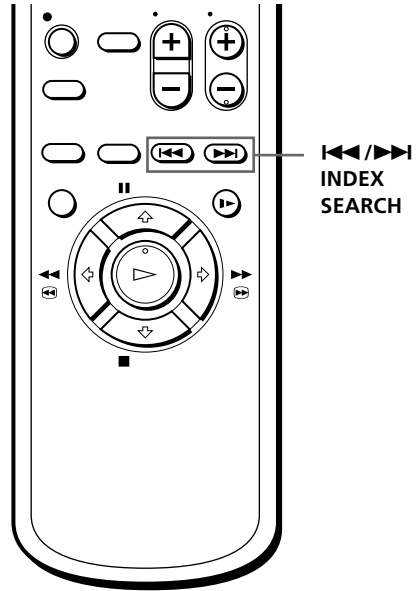

Using the INDEX SEARCH buttons on the remote commander

- 1 Insert an indexed tape into the VCR.
- 2 Press **◀◀/▶▶** INDEX SEARCH repeatedly to specify how many index signals ahead or behind you want to search:
 - To search ahead, press **▶▶** INDEX SEARCH.
 - To search backwards, press **◀◀** INDEX SEARCH.

The VCR starts searching and the index number on the TV screen counts down to zero. The playback starts from the point about five seconds ahead of the specified index mark.

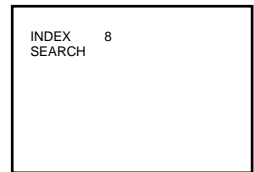

Using the SEARCH button and EASY TIMER knob on the VCR

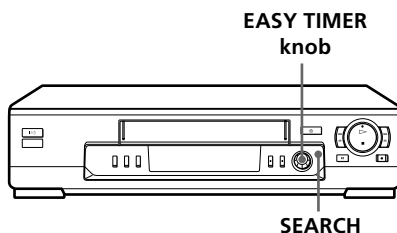

- 1 Press SEARCH on the VCR repeatedly until "INDEX" appears in the display window (the SEARCH indicator lights up).

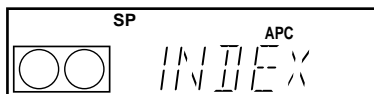

- 2 Turn the EASY TIMER knob to specify how many index signals ahead or behind you want to search:
 - To search ahead, turn the EASY TIMER knob clockwise.
 - To search backwards, turn the EASY TIMER knob counterclockwise.

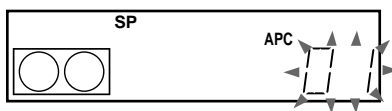

- 3 Press the EASY TIMER knob.

The VCR starts searching. The playback starts (the SEARCH indicator turns off) from the point about five seconds ahead of the specified index mark.

To stop searching

Press ■ STOP.

Note

- No index signal will be added when recording starts from recording pause. However, an index signal will be marked if you change the channel during recording pause.

Searching using the Time Search function

You can easily find a specific point on a tape by using the Time Search function. For example, you can find a recorded portion 15 minutes ahead of or behind the current position of a tape by using the Time Search function.

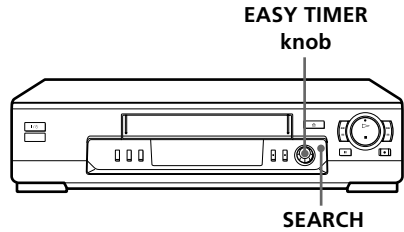

- 1 Press SEARCH repeatedly until "TIME" appears in the display window (the SEARCH indicator lights up).

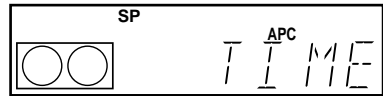

- 2 Turn the EASY TIMER knob clockwise or counterclockwise to set the length of the time portion you want the VCR to fast-forward or rewind the tape. Each turn on the knob increases or decreases the duration by 15 minutes.

For example, if you want to watch a recorded portion 15 minutes ahead of the current position, turn the EASY TIMER knob once clockwise.

To change the time by one minute, press PROGRAM +/-.



- 3 Press the EASY TIMER knob.

The VCR starts searching and the tape counter starts counting until it reaches the specified point.

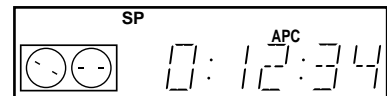

The VCR starts playback automatically when the tape counter reaches the specified point (the SEARCH indicator turns off).

To stop searching

Press ■ STOP.

Tip

- The VCR can search up to three hours ahead of or behind the current position of a tape.

Adjusting the picture

Adjusting the tracking

Although the VCR automatically adjusts the tracking when playing a tape (the  indicator flashes in the display window, then goes off), distortion may occur if the tape was recorded in poor condition. If so, manually adjust the tracking.

Press the TRACKING +/- buttons on the VCR to display the tracking meter. The distortion should disappear as you press one of the two buttons (the  indicator lights up). To resume automatic tracking adjustment, eject the tape and reinsert it.

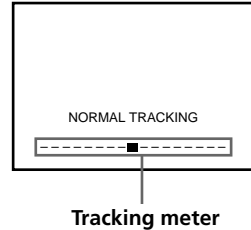

About the Adaptive Picture Control (APC) function

The Adaptive Picture Control (APC) function automatically improves recording and playback quality by adjusting the VCR to the condition of the video heads and tape. To maintain better picture quality, we recommend that you set APC to ON in the SET UP MENU (with the APC indicator in the display window lit).

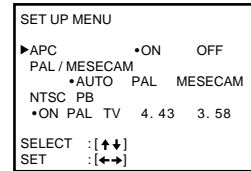

APC playback

The APC function automatically works on all types of tapes, including rental tapes and tapes that were not recorded with APC.

APC recording

Whenever you insert a tape and first start recording, the VCR adjusts the tape using the APC function (the APC indicator flashes rapidly). This adjustment is retained until the tape is ejected.

To deactivate the APC function

Press MENU and select SET UP MENU, then set APC to OFF. The APC indicator in the display window goes off.

continued

Adjusting the picture (continued)

Tip

- To set the tracking to the centre position, press the TRACKING + and – buttons at the same time.

Note

- There is a delay of a few seconds before the VCR actually starts recording while the VCR analyses the tape. To avoid the delay, first set the VCR to recording pause (the APC indicator flashes slowly) and press ● REC to have the VCR analyse the tape (the APC indicator flashes rapidly). After the APC indicator stops flashing, press ■■ PAUSE to start recording immediately. If you press ■■ PAUSE before the APC indicator stops flashing, the APC function is cancelled.

Changing menu options

- 1 Press MENU, then select SET UP MENU.

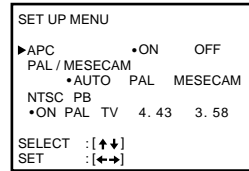

- 2 Press ↑/↓ to select the option to change, then press ←/→ to change the setting.
- 3 Press OK to return to the original screen.

Menu choices

Initial settings are indicated in bold print.

Menu option	Set this option to
APC	ON to switch on the APC (Adaptive Picture Control) function and improve picture quality. OFF to switch off APC.
PAL/MESECAM	AUTO to have the VCR automatically select the colour system for recording and playback. If the picture has no colour or unusual colours, set to PAL or MESECAM according to your local colour system.
NTSC PB	ON PAL TV to play back an NTSC-recorded tape on a PAL TV. 4.43 or 3.58 according to the colour system of your NTSC TV. For details, see page 19.

Editing with another VCR

How to connect to record on this VCR

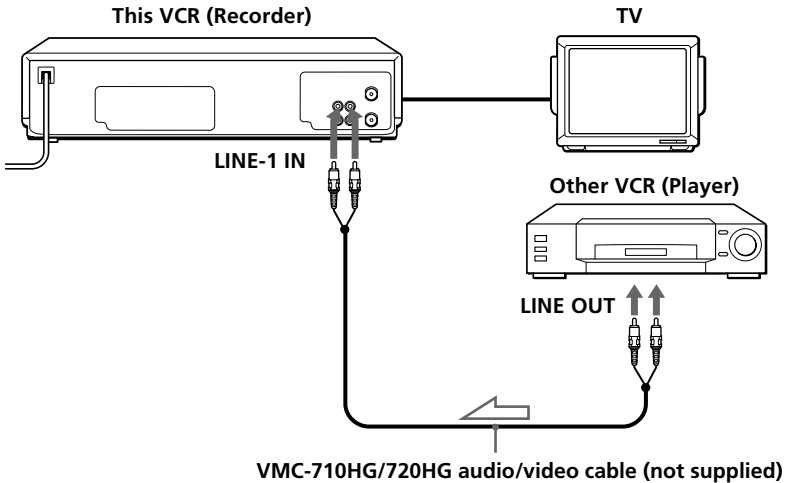

 : Signal flow

Tip

- Connect LINE-1 IN on this VCR to the line output jacks on the other VCR using a commercially available audio/video cable such as Sony VMC-710HG/720HG (not supplied). If the other VCR has the AUDIO L and R jacks, use a Sony VMC-910HG audio/video cable (not supplied).

Notes

- Make sure you connect the plugs to jacks of the same colour.
- If you connected this VCR to both the LINE IN and LINE OUT jacks of the other VCR, select the input correctly to prevent a humming noise.

Operation (when recording on this VCR)

Before you start editing

- Turn on your TV and set it to the video channel.
- Press INPUT SELECT or PROG +/- to display "L" in the display window.
- Press SP/LP (SP/EP) to select the tape speed (SP or LP for the PAL system, and SP or EP for the NTSC system).

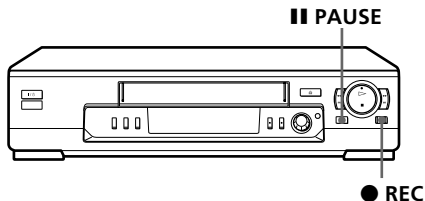

- 1 Insert a source tape with its safety tab removed into the other (playback) VCR. Search for the point to start playback and set it to playback pause.
- 2 Insert a tape with its safety tab in place into this (recording) VCR. Search for the point to start recording and press || PAUSE.
- 3 Press ● REC on this VCR and set it to recording pause.
- 4 To start editing, press the || PAUSE buttons on both VCRs at the same time.

To stop editing

Press the ■ STOP buttons on both VCRs.

Tips

- To edit more precisely, press the || PAUSE buttons on the VCRs to release pause.
- To cut out unwanted scenes while editing, press || PAUSE on this VCR when an unwanted scene begins. When it ends, press || PAUSE again to resume recording.

Note

- If you start recording following the procedure above, the VCR will not start recording with the APC function. To record a tape with the APC function, press ● REC again during recording pause in step 3 so that the VCR analyses the tape. Then when you start recording in step 4, press || PAUSE after the APC indicator stops flashing. If you press || PAUSE before the APC indicator stops flashing, the APC function is cancelled.

Troubleshooting

If you have any questions or problems not covered below, please consult your nearest Sony service facility.

	Symptom	Remedy
Power	The I/⏻ ON/STANDBY switch does not function.	<ul style="list-style-type: none"> • Connect the mains lead to the mains securely.
	The power is turned on but the VCR does not operate.	<ul style="list-style-type: none"> • Moisture condensation has occurred. Turn the power off, unplug the mains lead and leave the VCR to dry for over four hours.
Clock	The clock has stopped and “-:-” lights in the display window.	<ul style="list-style-type: none"> • The clock stops if the VCR is disconnected from the mains for more than eight hours (SLV-ED25PS/TH and ED15PS only) or 24 hours (SLV-ED33ME/MJ/SG only). Reset the clock (and timer).
Playback	The playback picture does not appear on the TV screen.	<ul style="list-style-type: none"> • Make sure the TV is set to the video channel. If you are using a monitor, set it to video input. • If you made connections using the aerial cable only, make sure the RF channel number is set correctly for your area.
	The playback picture has no colour or unusual colour.	<ul style="list-style-type: none"> • Set the PAL/MESECAM option in the SET UP MENU according to your local colour system.
	The picture or sound is distorted.	<ul style="list-style-type: none"> • Adjust the tracking with the TRACKING +/- buttons. • Make sure the colour system is set to the system that the tape was recorded in. • If you made connections using the aerial cable only, make sure the TV system is set correctly for your area.
Playback	The picture is not clear, or a message appears indicating that the video heads need cleaning.	<ul style="list-style-type: none"> • The video heads are dirty (page 48). Clean the video heads using the Sony T-25CLD, T-25CLW or E-25CLDR video head cleaning cassette. If these cleaning cassettes are not available in your area, have the heads cleaned at your nearest Sony service facility (a standard service charge will be required). Do not use a commercially available liquid type cleaning cassette other than Sony's, as they may damage the video heads. • If a message appears, this indicates that the Head Condition Sensor has detected dirty video heads. Follow the on-screen message. For details about the Head Condition Sensor, see page 48. • The video heads may have to be replaced. Consult your local Sony service facility for more information.
	The picture rolls vertically during picture search.	<ul style="list-style-type: none"> • Adjust the vertical hold control on the TV or monitor.
	The picture has no sound.	<ul style="list-style-type: none"> • The tape is defective. • If you made A/V connections, check the audio cable connection. • If you made connections using the aerial cable only, make sure the TV system is set correctly for your area.

	Symptom	Remedy
Recording	No TV programmes appear on the TV screen.	<ul style="list-style-type: none"> • Make sure the TV is set to the video channel. If you are using a monitor, set it to video input. • Select the correct source with the INPUT SELECT or PROG +/- buttons. Select a programme position when recording TV programmes; select "L" when recording from other equipment.
	TV reception is poor.	<ul style="list-style-type: none"> • Adjust the TV aerial. • Make sure SYSTEM (B/G, D/K or I) in the TUNER PRESET menu is set to the system in your area.
	The recorded picture has no colour or unusual colour.	<ul style="list-style-type: none"> • Set the PAL/MESECAM option in the SET UP MENU according to your local colour system.
	The tape starts playing as soon as it is inserted.	<ul style="list-style-type: none"> • The safety tab has been removed. To record on this tape, cover the tab hole.
	The tape is ejected when you press ● REC.	<ul style="list-style-type: none"> • Check that the safety tab has not been removed.
Timer recording	Nothing happens when you press ● REC.	<ul style="list-style-type: none"> • Make sure the tape is not at its end.
	The timer does not operate.	<ul style="list-style-type: none"> • Check that the clock is set. • Make sure a tape has been inserted. • Check that the safety tab has not been removed. • Make sure the tape is not at its end. • Make sure a programme has been set for timer recording. • Make sure your timer settings are past the current time. • The clock stops if the VCR is disconnected from the mains for more than eight hours (SLV-ED25PS/TH and ED15PS only) or 24 hours (SLV-ED33ME/MJ/SG only). Reset the clock and timer.
Others	A tape cannot be inserted.	<ul style="list-style-type: none"> • Check that a tape is not already in the tape compartment.
	The remote commander does not function.	<ul style="list-style-type: none"> • Make sure you are pointing the remote commander at the remote sensor on the VCR. • Replace all the batteries in the remote commander with new ones if they are weak. • Make sure the TV/VIDEO remote control switch is set correctly.
	The tracking meter does not appear on the screen.	<ul style="list-style-type: none"> • The recording condition of the tape is very poor and tracking cannot be adjusted.
	The VCR needs to be cleaned.	<ul style="list-style-type: none"> • Clean the cabinet, panel and controls with a dry, soft cloth, or a soft cloth slightly moistened with a mild detergent solution. Do not use any type of solvent, such as alcohol or benzine.

continued

Troubleshooting (continued)

Symptoms caused by contaminated video heads

- Normal picture



- Rough picture



initial
contamination

- Unclear picture



- No picture (or black & white screen appears)



terminal

Sapphire tape cleaner

The unit incorporates a sapphire tape cleaner which cleans a video tape when it is loaded. This cleaner can prevent the video heads from contamination by removing dust or mold from a tape with the sapphire edge.

Head Condition Sensor

The Head Condition Sensor checks the video heads condition. If the heads are dirty, a message will instruct you to insert a video head cleaning cassette.

Be sure to use the Sony T-25CLD, T-25CLW or E-25CLDR video head cleaning cassette. If these cleaning cassettes are not available in your area, have the heads cleaned at your nearest Sony service facility (a standard service charge will be required).

Specifications

System

Colour system

PAL, MESECAM, NTSC 3.58, NTSC 4.43

TV system

B/G, D/K, I

Channel coverage

B/G: VHF E2 to E12/UHF E21 to E69/

CATV S01 to S05, S1 to S41

D/K: VHF R1 to R12/UHF R21 to R69

I: VHF SA4 to SA13/UHF B21 to B69/

CATV S01 to S05, S1 to S41

RF output signal

UHF channels 21 to 69 (B/G, D/K, I)

Aerial out

75-ohm asymmetrical aerial socket

Inputs and outputs

LINE-1 IN

VIDEO IN, phono jack (1)

Input signal: 1 Vp-p, 75 ohms, unbalanced, sync negative

AUDIO IN, phono jack (1)

Input level: 327 mVrms

Input impedance: more than 47 kilohms

LINE-1 OUT

VIDEO OUT, phono jack (1)

Output signal: 1 Vp-p, 75 ohms, unbalanced, sync negative

AUDIO OUT, phono jack (1)

Standard output: 327 mVrms

Load impedance: 47 kilohms

Output impedance: less than 10 kilohms

General

Power requirements

110 – 240 V AC, 50/60 Hz

Power consumption

15 W

Operating temperature

5°C to 40°C

Storage temperature

-20°C to 60°C

Dimensions

Approx. 430 × 97 × 288 mm (w/h/d)

including projecting parts and controls

Mass

Approx. 4.1 kg

Power back-up

Built-in self-charging capacitor

Back-up duration: up to 8 hours at a time (SLV-ED25PS/TH and ED15PS only)

Back-up duration: up to 24 hours at a time (it may be differ in actual performance) (SLV-ED33ME/MJ/SG only)

Supplied accessories

Remote commander (1)

R6 (size AA) batteries (2)

Aerial cable (1)

Plug adaptor (1) (SLV-ED33ME/MJ only)

Design and specifications are subject to change without notice.

Index to parts and controls

Refer to the pages indicated in parentheses () for details.

Front panel

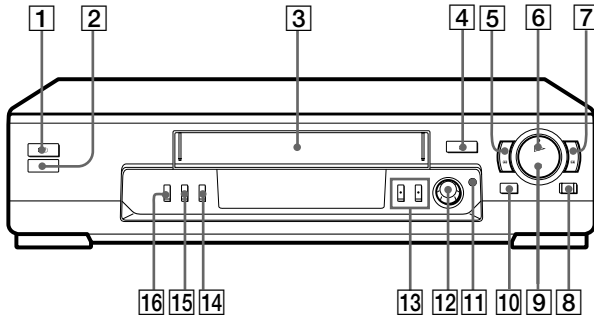

- 1 I/ON/STANDBY switch (7)
- 2 Remote sensor (5)
- 3 Tape compartment
- 4 EJECT button (19)
- 5 REW (rewind) button (19, 33)
- 6 PLAY button (19)
- 7 FF (fast-forward) button (19, 33)
- 8 REC (record) button (23)
- 9 STOP button (19)
- 10 PAUSE button (19)
- 11 SEARCH button/indicator (37, 39, 40)
- 12 EASY TIMER knob (25, 37, 39, 40)
- 13 PROGRAM/TRACKING +/- buttons (7, 41)
- 14 SP (Standard Play)/LP (Long Play)/EP (Extra Play) button (23)
- 15 COLOR SYSTEM button (19)
- 16 ONE TOUCH TUNING/RF (Radio Frequency) CHANNEL button (7, 10)

Display window

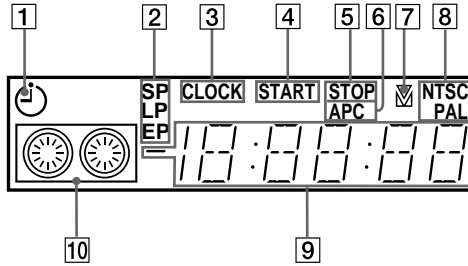

- | | |
|---|--|
| <ul style="list-style-type: none"> 1 Timer indicator (26) 2 Tape speed indicator (23) 3 CLOCK indicator (27) 4 START indicator (25) 5 STOP indicator (25) 6 APC (Adaptive Picture Control) indicator (41) | <ul style="list-style-type: none"> 7 Tracking indicator (41) 8 Colour system indicator (19) 9 Time counter/clock/line/programme/TV system indicator (8, 20, 22, 27, 45) 10 Tape/recording indicator (23) |
|---|--|

Rear panel

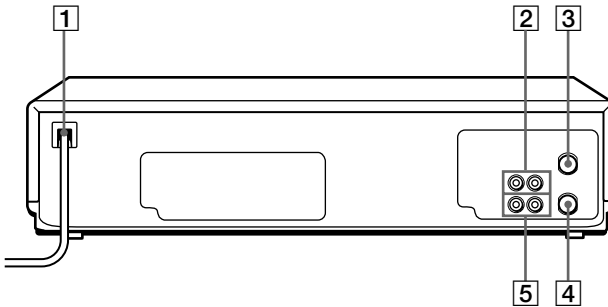

- | | |
|--|--|
| <ul style="list-style-type: none"> 1 Mains lead (6) 2 LINE-1 IN AUDIO/VIDEO jacks (44) 3 AERIAL IN connector (6) | <ul style="list-style-type: none"> 4 AERIAL OUT connector (6) 5 LINE-1 OUT AUDIO/VIDEO jacks (6) |
|--|--|

continued

Index to parts and controls (continued)

Remote commander

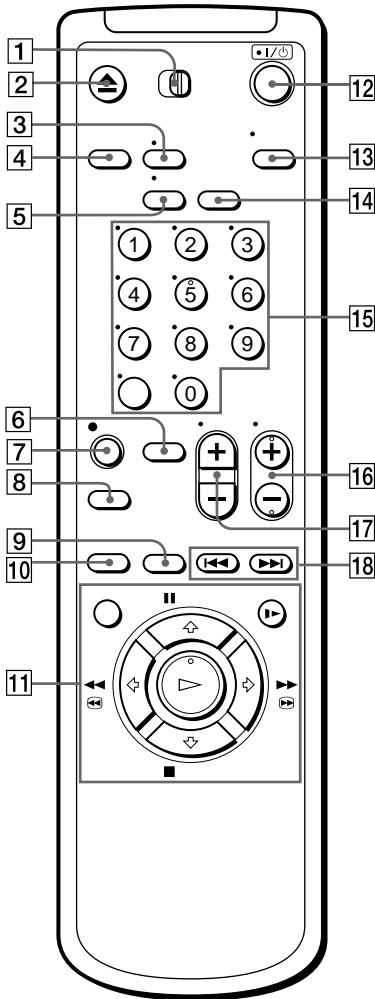

- 1 **TV / VIDEO** remote control switch (5)
- 2 **▲ EJECT** button (19)
- 3 **DISPLAY** button (23)
- 4 **TRINITRON TV SYNCHRO PLAY** button (21)
- 5 **TV/VIDEO** button (*for TV*) (5)
- 6 **EASY TIMER** button (28)
- 7 **● REC** button (23, 34)
- 8 **SP (Standard Play)/LP (Long Play)/EP (Extra Play)** button (23)
- 9 **×2** button (33)
- 10 **INPUT SELECT** button (24, 32)
- 11 **Tape/menu operation buttons**
 - MENU button (9, 43)
 - ⏸ **PAUSE/▲** button (19)
 - **STOP/▼** button (19)
 - ◀ **REW (rewind)/◀** button (19, 33)
 - ▶▶ **FF (fast-forward)/▶** button (19, 33)
 - ▷ **PLAY/OK** button (19)
 - ▶ **SLOW** button (33)
- 12 **I/⏻ (on/standby)** switch (32)
- 13 **AUDIO MONITOR** button (*This button doesn't work for this model*)
- 14 **CLEAR** button (20, 36)
- 15 **Programme number /-/-- (ten's digit) buttons** (28)
- 16 **PROG (programme) +/-** buttons (22)
- 17 **VOL (volume) +/-** buttons (*for TV*)
- 18 **◀◀/▶▶** **INDEX SEARCH** buttons (38)

Index

A, B

- Accessories supplied 4
- Adjusting
 - picture 15, 33, 41
 - tracking 33, 41
- Aerial hookup 6
- AFT (Auto Fine Tuning) 15
- APC (Adaptive Picture Control) 41
- AV (audio/video) connection 6

C

- Cancelling timer settings 35
- Changing timer settings 35
- Checking timer setting 35
- Cleaning the video heads 46
- Clock setting 16
- Colour system
 - compatible colour systems 2
 - setting 19, 43
- Connecting
 - the VCR and your TV 6
 - to a TV with audio/video jacks 6
- Counter 20

D

- Disabling programme position 15
- Dubbing. *See* Editing

E, F, G

- Easy Clock 27
- Easy Timer recording 25
- Editing 44
- EP mode 24

H

- Head Condition Sensor 48

I, J, K

- Index searching 38

L, M

- Language selecting 9
- LP mode 23

N, O

- NTSC-recorded tapes 19
- One Touch Tuning 10

P, Q

- Picture adjustment 15, 33, 41
- Playback 18
 - at various speeds 33
 - frame-by-frame 33
 - slow motion 33
- Presetting channels 10
 - automatically 11
 - manually 13
- One Touch Tuning 10

R

- Recording 22
 - duration time 34
 - saving 23
 - using the Easy Timer function 25
 - while watching another programme 23
- Remote commander 5

S

- Safety tab 23
- Searching
 - at various speeds 33
 - the beginning of an Easy Timer recorded programme 37
 - using the index function 38
 - using the Time Search function 40
- SP mode 23

T, U, V, W, X, Y, Z

- Time Search 40
- Timer recording 31
 - cancelling timer settings 35
 - changing timer settings 35
 - checking timer settings 35
 - daily/weekly recording 32
 - Easy Timer 25
 - overlapping timer recordings 36
- Tracking adjustment 33, 41
- Trinitron TV Synchro Play 21
- Tuning your TV to the VCR 7
- TV system 2, 8, 14