

Digital Still Camera

Operating Instructions

Before operating the unit, please read this manual thoroughly, and retain it for future reference.

Owner's Record

The model and serial numbers are located on the bottom. Record the serial number in the space provided below. Refer to these numbers whenever you call upon your Sony dealer regarding this product.

Model No. _____

Serial No. _____

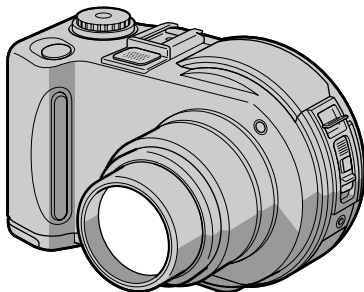

MVC-CD300

CD Mavica



MVC-CD200/CD300

WARNING

To prevent fire or shock hazard, do not expose the unit to rain or moisture.

For the Customers in the U.S.A.

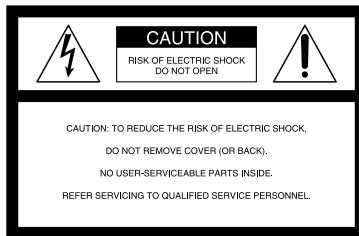

This symbol is intended to alert the user to the presence of uninsulated “dangerous voltage” within the product’s enclosure that may be of sufficient magnitude to constitute a risk of electric shock to persons.



This symbol is intended to alert the user to the presence of important operating and maintenance (servicing) instructions in the literature accompanying the appliance.

CAUTION

The use of optical instruments with this product will increase eye hazard. As the laser beam used in this camera is harmful to eyes, do not attempt to disassemble the cabinet.
Refer servicing to qualified personnel only.

If you have any questions about this product, you may call:

Sony Customer Information Center
1-800-222-SONY (7669)

The number below is for the FCC related matters only.

Regulatory Information

Declaration of Conformity

Trade Name: SONY
Model No.: MVC-CD200
Responsible Party: Sony Electronics Inc.
Address: 680 Kinderkamack
Road, Oradell, NJ
07649 USA

Telephone No.: 201-930-6972

This device complies with Part 15 of the FCC Rules. Operation is subject to the following two conditions: (1) This device may not cause harmful interference, and (2) this device must accept any interference received, including interference that may cause undesired operation.

Declaration of Conformity

Trade Name: SONY
Model No.: MVC-CD300
Responsible Party: Sony Electronics Inc.
Address: 680 Kinderkamack
Road, Oradell, NJ
07649 USA

Telephone No.: 201-930-6972

This device complies with Part 15 of the FCC Rules. Operation is subject to the following two conditions: (1) This device may not cause harmful interference, and (2) this device must accept any interference received, including interference that may cause undesired operation.

CAUTION

You are cautioned that any changes or modifications not expressly approved in this manual could void your authority to operate this equipment.

Note:

This equipment has been tested and found to comply with the limits for a Class B digital device, pursuant to Part 15 of the FCC Rules. These limits are designed to provide reasonable protection against harmful interference in a residential installation. This equipment generates, uses, and can radiate radio frequency energy and, if not installed and used in accordance with the instructions, may cause harmful interference to radio communications. However, there is

no guarantee that interference will not occur in a particular installation. If this equipment does cause harmful interference to radio or television reception, which can be determined by turning the equipment off and on, the user is encouraged to try to correct the interference by one or more of the following measures:

- Reorient or relocate the receiving antenna.
- Increase the separation between the equipment and receiver.
- Connect the equipment into an outlet on a circuit different from that to which the receiver is connected.
- Consult the dealer or an experienced radio/TV technician for help.

The supplied interface cable must be used with the equipment in order to comply with the limits for a digital device pursuant to Subpart B of Part 15 of FCC Rules.

About Ferrite Core

Be sure to attach the supplied ferrite core to the cable of the AC power adaptor. This ferrite core can reduce noises. Refer to the addendum for the details.

For the Customers in the U.S.A. and Canada

DISPOSAL OF LITHIUM ION BATTERY.

LITHIUM ION BATTERY.

DISPOSE OF PROPERLY.

You can return your unwanted lithium ion batteries to your nearest Sony Service Center or Factory Service Center.

Note:

In some areas the disposal of lithium ion batteries in household or business trash may be prohibited.

For the Sony Service Center nearest you call 1-800-222-SONY (United States only)
For the Sony Factory Service Center nearest you call 416-499-SONY (Canada only)

Caution:

Do not handle damaged or leaking lithium ion battery.

For the Customers in the United Kingdom

A moulded plug complying with BS 1363 is fitted to this equipment for your safety and convenience.

Should the fuse in the plug supplied need to be replaced, a 5 AMP fuse approved by ASTA or BSI to BS 1362, (i.e. marked with ⚡ or ⚡ mark) must be used.

If the plug supplied with this equipment has a detachable fuse cover, be sure to attach the fuse cover after you change the fuse. Never use the plug without the fuse cover. If you should lose the fuse cover, please contact your nearest Sony service station.

For the Customers in Germany

Directive: EMC Directive 89/336/EEC, 92/31/EEC

This equipment complies with the EMC regulations when used under the following circumstances:

- Residential area
- Business district
- Light-industry district

(This equipment complies with the EMC standard regulations EN55022 Class B.)

For the Customers in Europe

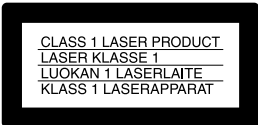

CLASS 1 LASER PRODUCT
LASER KLASSE 1
LUOKAN 1 LASERLÄITE
KLASSE 1 LASERAPPARAT

Attention

The electromagnetic fields at the specific frequencies may influence the picture and sound of this camera.

This product has been tested and found compliant with the limits sets out on the EMC Directive for using connection cables shorter than 3 meters (9.8 feet).

Be sure to read the following before using your camera

Operating instructions

Before operating the unit, please read this manual thoroughly, and retain it for future reference.

The instructions in this manual are for the two models: MVC-CD200, MVC-CD300. The MVC-CD300 is the model used for illustration purposes.

Otherwise, the model name is indicated in the illustrations. Any differences in operation are clearly indicated in the text, for example, "MVC-CD300 only."

As you read through this manual, buttons and settings on the camera are shown in capital letters.

e.g. Press DISPLAY/LCD BACK LIGHT ON/OFF.

This digital still camera uses 8 cm CD-Rs/CD-RWs as recording media. "CD-R" or "CD-RW" mentioned above is indicated as "disc" in this manual. When a distinction between CD-Rs and CD-RWs is necessary, "disc" is indicated as "CD-R" or "CD-RW."

- We recommend that you use this camera with Mavica discs*.
- While the image is being recorded on the disc, the ACCESS lamp lights up (red). When this lamp is lit, do not shake or strike the camera.

* The Mavica disc is an 8 cm CD-R/CD-RW with the Mavica logo.

Trial recording

Before you record one-time events, you may want to make a trial recording to make sure that the camera is working correctly.

No compensation for contents of the recording

Contents of the recording cannot be compensated for if recording or playback is not made due to a malfunction of your camera or recording medium, etc.

Notes on image data compatibility

- This camera conforms with the Design rule for Camera File system universal standard established by the JEITA (Japan Electrics

and Information Technology Industries Association).

- Playback of images recorded with your camera on other equipment and playback of images recorded or edited with other equipment on your camera are not guaranteed.

Precaution on copyright

Television programs, films, video tapes, and other materials may be copyrighted.

Unauthorized recording of such materials may be contrary to the provision of the copyright laws.

Do not shake or strike the camera

In addition to malfunctions and inability to record images, this may render the discs unusable or image data breakdown, damage or loss may occur.

LCD screen, finder (only models with a finder) and lens

- The LCD screen and the finder are manufactured using extremely high-precision technology so over 99.99% of the pixels are operational for effective use. However, there may be some tiny black points and/or bright points (white, red, blue or green in color) that constantly appear on the LCD screen and the finder. These points are normal in the manufacturing process and do not affect the recording in any way.
- Be careful when placing the camera near a window or outdoors. Exposing the LCD screen, the finder or the lens to direct sunlight for long periods may cause malfunctions.

Do not get the camera wet

When taking pictures outdoors in the rain or under similar conditions, be careful not to get the camera wet. If moisture condensation occurs, refer to page 87 and follow the instructions on how to remove it before using the camera.

Back up recommendation

To avoid the potential risk of data loss, always copy (back up) data to a disc.

When the camera is used for long periods

Note that the camera body may become hot.

Handling of the movable lens

This camera uses a movable lens. Be careful not to strike or apply excessive force to the lens portion.

Table of contents

Introduction	6
--------------------	---

Getting started

Identifying the parts	7
Preparing the power supply	9
Setting the date and time	14
Inserting a disc	16

Basic operations

► Recording

Initializing a disc (INITIALIZE)	18
Recording still images	20
Recording moving images	26

► Playback

Playing back still images	28
Playing back moving images	29
Preparation for viewing images using a computer	31
Viewing images using a computer ...	35
Image file storage destinations and image file names	43

Advanced operations

Before performing advanced operations

How to use the mode dial	45
How to use the control button	46
How to use the jog dial	48
Menu settings	49
Setting the image size (IMAGE SIZE)	53

► Various recording

Recording with the exposure fixed (AE LOCK)	55
Recording with the manual adjustments	56
Recording images according to shooting conditions (SCENE SELECTION)	58
Recording three images continuously (BURST) (only for MVC-CD300)	59
Recording still images for e-mail (E-MAIL)	59
Adding audio files to still images (VOICE)	60

Recording text documents (TEXT) ...	61
Recording still images as uncompressed files (TIFF)	62
Recording three images with the exposure shifted (only for MVC-CD300) (EXP BRKTG)	63
Creating Clip Motion Files	64
Setting the distance to the subject	66
Recording images in macro	66
Adjusting the exposure (EXPOSURE)	67
Adjusting the white balance (WHITE BALANCE)	68
Enjoying picture effects (P. EFFECT)	69
Recording the date and time on the still image (DATE/TIME)	70
Using the Spot light-metering function	71

► Various playback

Playing back three or nine images at once	72
Enlarging a part of the still image (Zoom and trimming)	73
Playing back the still images in order (SLIDE)	74
Rotating a still image (ROTATE)	75
Viewing images on a TV screen	76

► Editing

Deleting images (DELETE)	77
Preventing accidental erasure (PROTECT)	78
Changing the recorded still image size (RESIZE)	80
Selecting still images to print (PRINT)	81
Formatting a CD-RW	82
Changing the setup settings (SET UP)	84

Additional information

Precautions	87
On discs	89
Using your camera abroad	90
About "InfoLITHIUM" battery pack	91
Troubleshooting	93
Warning and notice messages	100
Self-diagnosis display	102
Specifications	103
LCD screen indicators	105
Index	Back cover

Introduction

Captures images with your computer

You can easily copy images onto your computer through a CD-ROM drive, CD-R drive, CD-RW drive, or the USB cable and view and modify images on your computer using application software. When using a CD-ROM drive to view images on your computer, the finalization is required (page 32).

Flow chart for disc operations

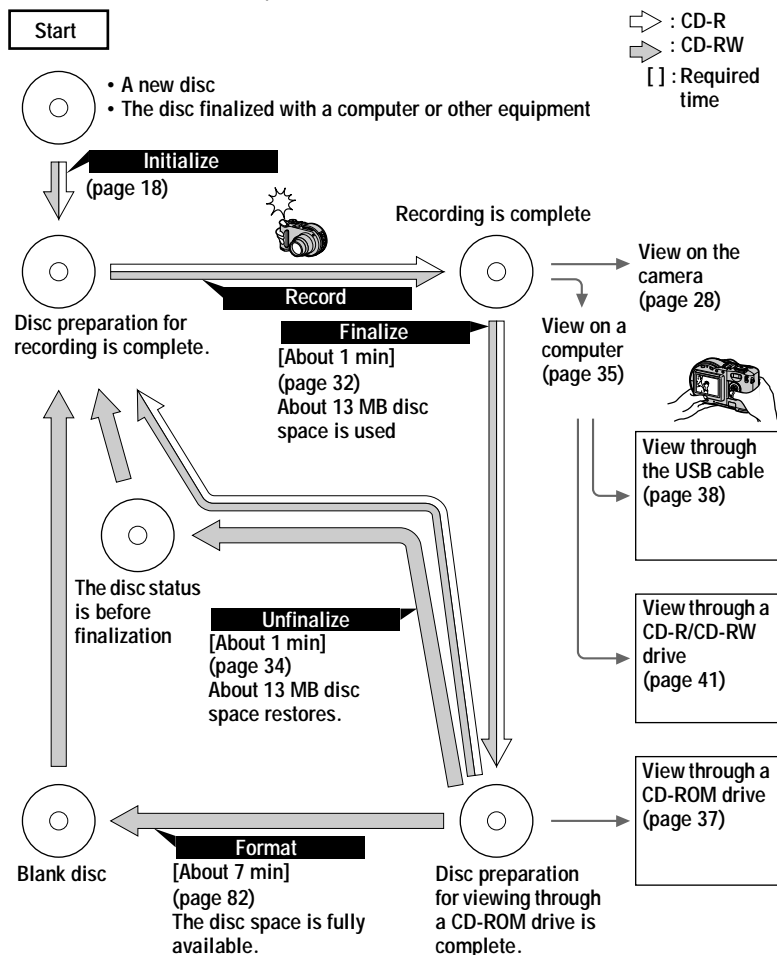

Identifying the parts

See the pages in parentheses for details of operation.

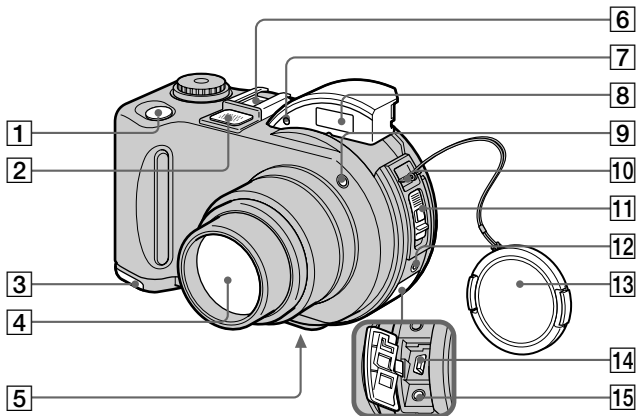

1 Shutter button (20, 26)

2 Built-in microphone

Do not touch while recording.

3 Battery cover (bottom surface) (9)

4 Lens

5 Tripod receptacle (bottom surface)

Use a tripod with a screw length of less than 6.5 mm (7/32 inch). You cannot firmly secure the camera to tripods having longer screws, and may damage the camera.

6 Accessory shoe

7 Photocell window for flash

Do not block while recording with the flash.

8 Flash (24)

9 Self-timer lamp/AF illuminator (24, 25)

10 Hook for strap and lens cap

11 Disc cover OPEN lever (16)

12 ACC (Accessory) jack

Connects an external flash or other equipment.

13 Lens cap (supplied)

14 USB jack (38)

15 A/V OUT (MONO) jack (76)

Audio output is monaural.

About the Carl Zeiss lens (MVC-CD300 only)

This camera is equipped with a Carl Zeiss lens which is capable of reproducing fine images. The lens for this camera uses the MTF* measurement system for cameras developed jointly by Carl Zeiss, in Germany, and Sony Corporation, and offers the same quality as other Carl Zeiss lenses.

* MTF is an abbreviation of Modulation Transfer Function/Factor, a numeric value indicating the amount of light from a specific part of the subject gathered at the corresponding position in the image.

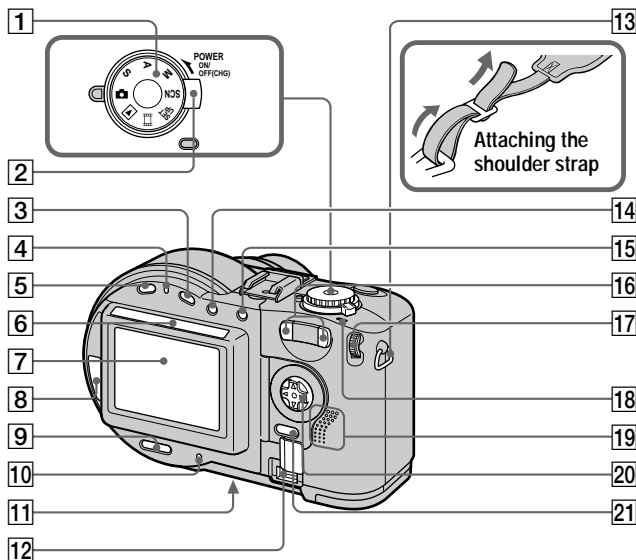

- | | |
|---|--|
| 1 Mode dial (45) | 13 Hook for strap |
| 2 POWER switch (14) | 14 [•] (Spot meter) button (71) |
| 3 (Exposure) button (67) | 15 AE LOCK button (55) |
| 4 /CHG (Charge) lamp (10, 25) | 16 Zoom W/T buttons (22) |
| 5 FOCUS button (66) | 17 Jog dial (48) |
| 6 Photocell window for LCD screen
The LCD screen becomes brighter when exposed to sunlight. | 18 POWER ON/OFF (CHG) lamp (14) |
| 7 LCD screen | 19 Speaker |
| 8 Disc window | 20 Control button (46) |
| 9 DISPLAY/LCD BACK LIGHT ON/OFF button (23) | 21 MENU button (46) |
| 10 ACCESS lamp (20) | |
| 11 Reset button (99) | |
| 12 DC IN cover/DC IN jack (10, 13) | |

Preparing the power supply

Installing the battery pack

Your camera operates only with the NP-FM50 (supplied) “InfoLITHIUM” battery pack* (M series). See page 91 for more information about “InfoLITHIUM” battery pack.

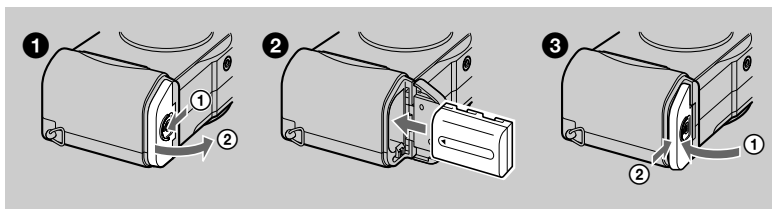

- 1 Open the battery cover.**
Slide the battery cover in the direction of the arrow.
- 2 Install the battery pack.**
Insert the battery pack with the ▲ mark facing toward the battery compartment as illustrated.
- 3 Close the battery cover.**

To remove the battery pack

Open the battery cover. Slide the battery eject lever in the arrow direction, and remove the battery pack.

Be careful not to drop the battery pack when removing it.

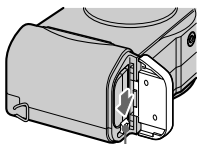

Battery eject lever

* What is “InfoLITHIUM”?

“InfoLITHIUM” is a lithium ion battery pack which can exchange information such as battery consumption with compatible video equipment. “InfoLITHIUM” M series battery packs have the  mark. “InfoLITHIUM” is a trademark of Sony Corporation.

Charging the battery pack

When the camera is turned on, you cannot charge the battery pack. Be sure to turn off the power of the camera.

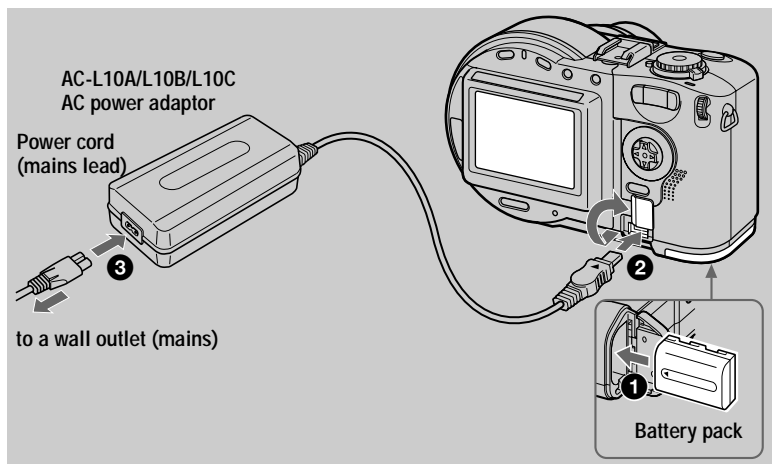

- 1** Insert the battery pack into your camera.
- 2** Open the DC IN cover and connect the AC power adaptor to the DC IN jack of your camera with the ▲ mark facing up.
- 3** Connect the power cord (mains lead) to the AC power adaptor and then to a wall outlet (mains).
The ⚡/CHG lamp (orange) above the LCD screen lights up when charging begins. When the ⚡/CHG lamp goes off, **full charge** is completed.

After charging the battery pack

Disconnect the AC power adaptor from the DC IN jack on your camera.

Battery remaining indicator

The LCD screen on the camera shows the remaining time for which you can still record or play back images.

This indication may not be entirely accurate depending on the conditions of use and the operating environment.

Charging at a room temperature of 10°C to 30°C (50°F to 86°F) is recommended.

Using your camera abroad

For details, see page 90.

NP-FM50 (supplied) battery pack

When you record images in an extremely cold location or using the LCD backlight, the operating time becomes short. When using the camera in an extremely cold location, place the battery pack in your pocket or other places to keep it warm, then insert the battery pack into the camera just before recording. When using a pocket heater, take care not to let the heater directly contact the battery.

Note on the /CHG lamp during charging

The /CHG lamp may flash:

- When a malfunction occurs in the battery pack (page 99).

The /CHG lamp does not light up:

- When the battery pack is not installed properly.

Charging time

Battery pack	Full charge (min.)
NP-FM50 (supplied)	Approx. 150

Approximate time to charge a completely discharged battery pack at a temperature of 25°C (77°F).

Battery life and number of images that can be recorded/played back

Still image recording/playback

	NP-FM50 (supplied)	
	Battery life (min.)	Number of images
Continuous recording*	Approx. 75	Approx. 800
Continuous playback**	Approx. 120	Approx. 1000

Approximate battery life and number of images that can be recorded/played back at a temperature of 25°C (77°F) with a fully charged battery pack, using 640×480 image size, standard image quality, and NORMAL recording mode.

* Recording at about 5-second intervals

** Playing back single-displayed images continuously at about 7-second intervals

Moving image recording

	NP-FM50 (supplied)
	Battery life (min.)
Continuous recording	Approx. 120

Approximate time that can be recorded 160×112-sized images at a temperature of 25°C (77°F) with a fully charged battery pack.

Notes

- The battery life and number of images will be decreased when using at low temperature, using the flash, turning the power on/off frequently, or using the zoom.
- The numbers of images shown on tables above are as a guide. The numbers may be smaller depending on conditions.
- If sufficient battery remaining time is indicated but the power runs out soon, fully charge the battery so that the correct battery remaining time appears.
- Do not short the DC plug of the AC power adaptor with a metallic object, as this may cause a malfunction.

Using the AC power adaptor

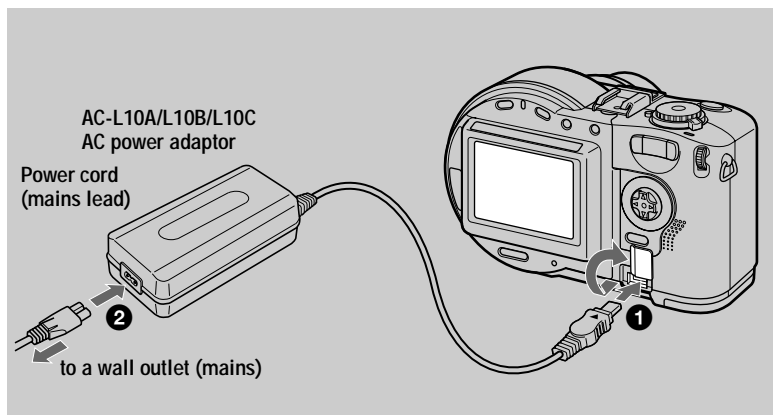

- 1** Open the DC IN cover and connect the AC power adaptor to the DC IN jack of your camera with the ▲ mark facing up.
- 2** Connect the power cord (mains lead) to the AC power adaptor and then to a wall outlet (mains).

Using a car battery

Use a Sony DC adaptor/charger.

When using the AC power adaptor

Be sure to use it near the wall outlet (mains). If a malfunction occurs, disconnect the plug from the wall outlet (mains).

Setting the date and time

When you first use your camera, set the date and time. If these are not set, the CLOCK SET screen appears whenever you turn on your camera.

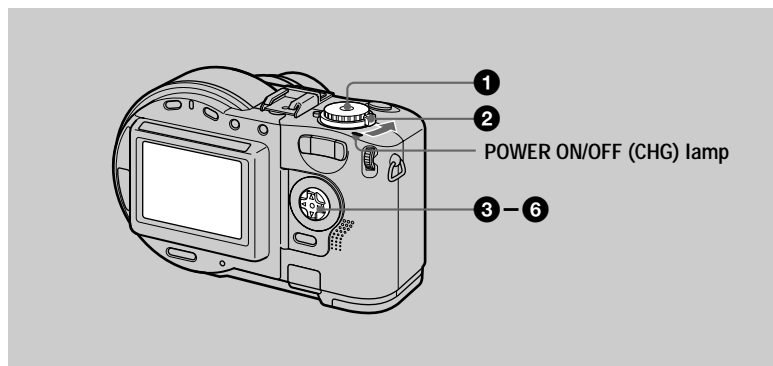

1 Set the mode dial to , S, A, M, , SCN, or .

2 Push the POWER switch in the arrow direction to turn on the power.

The POWER ON/OFF (CHG) lamp (green) lights up.

The CLOCK SET screen appears.

When resetting the date and time once you set, set the mode dial to SET UP (page 84), and then follow the procedure from step **3**.

3 Select the desired date display format with / on the control button, then press the center .

Select from [Y/M/D] (year/month/day), [M/D/Y] (month/day/year), or [D/M/Y] (day/month/year).

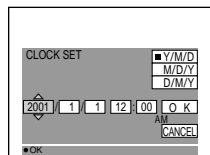

4 Select the year, month, day, hour or minute item you want to set with / on the control button.

The item to be set is indicated with / .

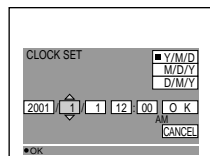

- 5** Set the numeric value with ▲/▼ on the control button, then press the center ● to enter it.

After entering the number, ▲/▼ moves to the next item. If you selected [D/M/Y] in step 3, set the time on a 24-hour cycle.

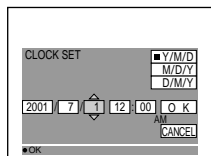

- 6** Select [OK] with ► on the control button, then press the center ● at the desired moment to begin clock movement.

The date and time are entered.

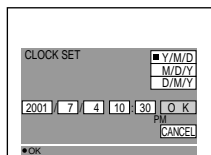

To cancel the date and time setting

Select [CANCEL] with ▲/▼/◀/▶ on the control button, then press the center ●.

Note

If the rechargeable button battery is ever fully discharged (page 89), the CLOCK SET screen will appear again. When this happens, reset the date and time, by starting from step 3 above.

Inserting a disc



You can use only the 8 cm CD-Rs or 8 cm CD-RWs that have these marks.

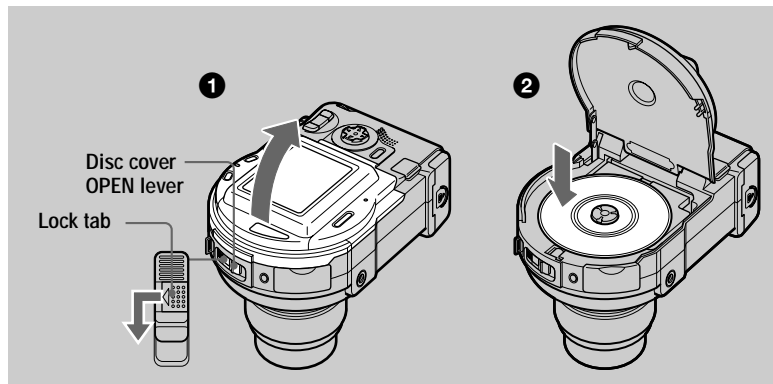

- 1 While sliding the lock tab to the left, slide down the disc cover OPEN lever.**

Open the disc cover by your hand after the cover is unlocked.

- 2 Place a disc with the printed side up.**

Push down the center of the disc until it clicks. When installing, do not push with too much force and do not touch the pickup lens.

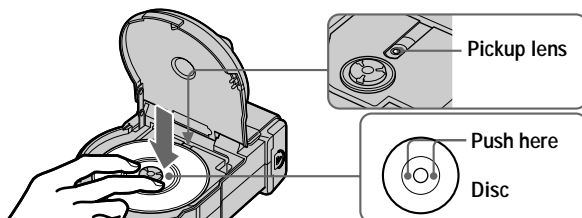

- 3 Close the disc cover.**

Removing the disc

While sliding the lock tab to the left, slide down the disc cover OPEN lever, and open the disc cover after the cover is unlocked. Then, remove the disc as illustrated below.

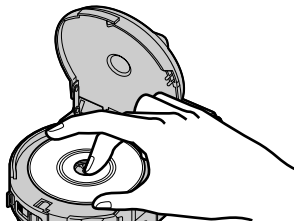





Notes

- Before removing the disc, be sure to check that the disc is not rotating.
- Do not open the disc cover while the ACCESS lamp is lit. If you do, the recorded image may be damaged or the disc may become unusable.
- When writing data on a disc or connecting with a computer using the USB connection, the disc cover OPEN lever is locked.

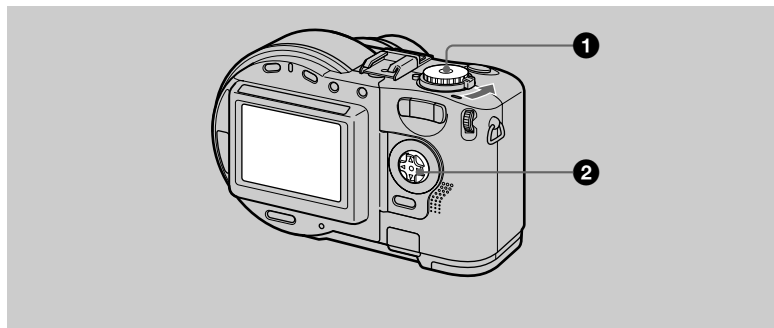
Initializing a disc (INITIALIZE)



When you use a new disc or the disc which was finalized with other equipment than this camera (page 32), you have to initialize the disc. Before initializing the disc, push the POWER switch in the arrow direction to turn on the power and insert the disc.



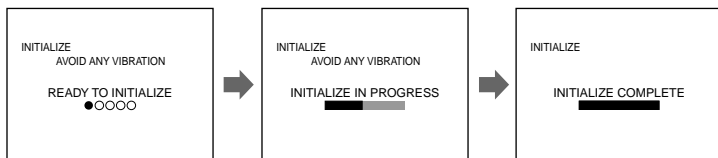



- 1 **Set the mode dial to , S, A, M, SCN, or .**
 "INITIALIZE PLACE ON LEVEL SURFACE" appears on the LCD screen.
 Be sure to avoid any vibration during the initialization in step 2.
- 2 **Select [OK] with  on the control button, then press the center .**
 Initialization starts.



To cancel the initialization

Select [CANCEL] with  on the control button, then press the center .

To initialize after canceling the initialization

Open and close the disc cover. Or set the mode dial to , S, A, M, SCN, or , press  on the control button, then press the center .

What is initialization?

The initialization is required to record images on a disc.

In case that you have executed the finalization (page 32) using the camera to view images on a CD-ROM drive, the initialization is automatically executed. You can continuously record images. When executing the finalization using a computer or other equipment, execute the initialization to record new images. Images recorded before finalization will remain on the disc.

Tip

You can also execute the initialization using [] (DISC TOOL) in the setup settings (page 84).

Recording still images

Still images are recorded in JPEG format. Before recording still images, push the POWER switch in the arrow direction to turn on the power and insert a disc.

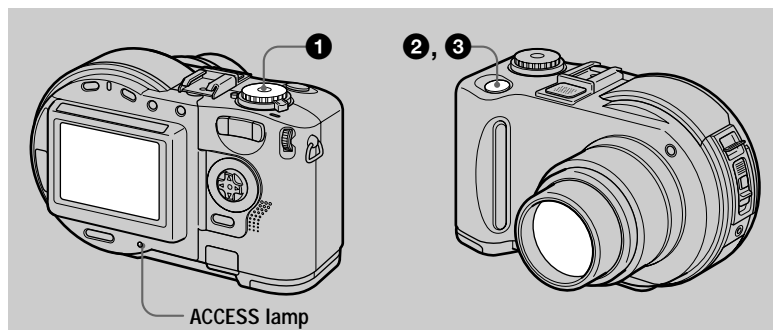

1 Set the mode dial to , S, A, M, or SCN.

2 Press and hold the shutter button halfway down.

The beeps sound. However, **the image has not been recorded yet**. While the AE/AF lock indicator ● is flashing, the camera automatically adjusts the exposure and focus of the captured image. When the camera finishes the automatic adjustments, **the AE/AF lock indicator ● stops flashing, then lights up, and the camera is ready for recording**.

If you release the shutter button, the recording will be canceled.

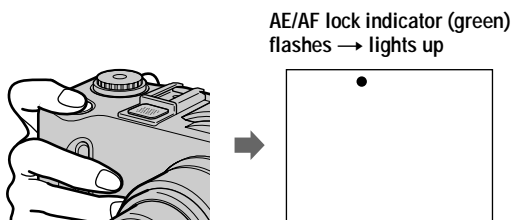

3 Press the shutter button fully down.

The shutter clicks. "RECORDING" appears on the LCD screen, and the image will be recorded on the disc. When "RECORDING" disappears from the LCD screen, you can start the next recording.

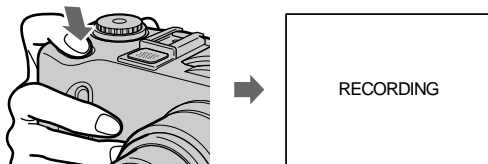

For the number of images you can record on a disc



See page 54.

Auto power-off function

If you do not operate the camera for about three minutes with the battery pack used as a power source, the camera turns off automatically to prevent wearing down the battery pack. To use the camera again, push the POWER switch in the arrow direction to turn on the camera again. However, when a device is connected to the USB or AV/OUT (MONO) jack, or when a moving image is played back, the auto power-off function does not work. (When using the slide show function, the power is automatically turned off after about 20 minutes regardless of the power source (the battery pack or the AC power adaptor).)

While the image is being recorded on a disc, the ACCESS lamp lights. When this lamp is lit, do not shake or strike the camera. Also, do not turn the power off, not remove the battery pack/disc, or not open the disc cover. Otherwise, an image data breakdown may occur or the disc may become unusable.

Notes

- When using a CD-R, even if you delete images, the disc remaining space does not increase.
- Only when using a CD-RW, the disc remaining space increases after deleting the last-recorded image if the  is indicated on the LCD screen before deleting. If you modify an image, or open and close the disc cover,  will disappear.
- When recording bright subjects, the color of the LCD screen may change after the AE is locked. However, this will not affect the recorded image.
- After you change the disc, "REPAIRING DATA" appears on the LCD screen and it may take about 10 minutes to get ready for recording depending on the disc condition.
- When you press the shutter button fully down at once, the camera starts recording after the automatic adjustment is complete. However, the recording cannot be carried out while the  / CHG lamp (page 8) is flashing. (During this time, the camera is charging the flash.)
- When the AE/AF lock indicator flashes slowly, the subject may be hard to focus on because it is too dark or no contrast, or it may be too close to the camera. Release the shutter button, and focus on it again.

Checking the last recorded image (Quick Review)

You can check the last recorded image by clearing the menu from the screen (page 46) and pressing ◀ (⊖) on the control button.

To return to the normal recording mode: press the shutter button lightly, or press ◀ (⊖) again.

To delete the image: 1. Press MENU. 2. Select [DELETE] with ▶, then press the center ●. 3. Select [OK] with ▲, then press the center ●.

Adjusting the brightness of the LCD screen

Adjust the brightness with the [LCD BRIGHTNESS] item in the setup settings (page 85). This adjustment does not affect the brightness of the images recorded on the disc.

To turn off the LCD backlight

Press DISPLAY/LCD BACK LIGHT ON/OFF repeatedly to turn off the LCD backlight (page 23). The battery life will be longer.

Using the zoom feature

The lens part moves in/out while zooming. Be careful not to touch the lens.

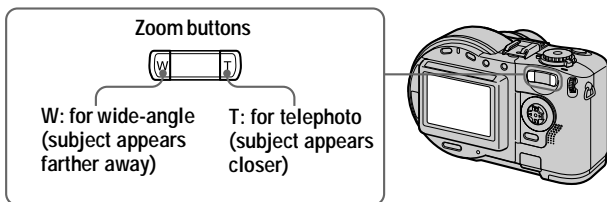

Minimum focal distance to the subject

W side: Approx. 50 cm (19 3/4 inches) (MVC-CD200)

Approx. 50 cm (19 3/4 inches) (MVC-CD300)

T side: Approx. 60 cm (23 5/8 inches) (MVC-CD200)

Approx. 50 cm (19 3/4 inches) (MVC-CD300)

To record even closer subjects, see page 66.

Digital zoom function

This camera has a digital zoom function.

Digital zoom enlarges the image by digital processing, and it starts to function when the zoom exceeds 3×.

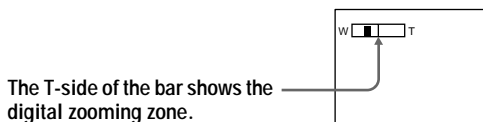

Using digital zoom

- The maximum zoom magnification is 6×.
- Digital zooming deteriorates the picture quality. When digital zoom is not necessary, set [DIGITAL ZOOM] to [OFF] in the setup settings (page 84).

Notes

- Digital zoom does not work for moving images.
- The zoom function does not work while recording a moving image. Set the zoom position before you start recording (MVC-CD300 only).
- The AF frame (page 105) does not appear on the LCD screen.

The indicators on the LCD screen during recording

Each time you press DISPLAY/LCD BACK LIGHT ON/OFF, the status of the LCD screen changes as follows:

The LCD backlight is turned on/all the available indicators are turned on

→ The LCD backlight is turned on/warning messages and manual adjustment items which are set using the jog dial are turned on

→ The LCD backlight is turned off/warning messages and manual adjustment items which are set using the jog dial are turned on

See page 105 for a detailed description of the indicators.

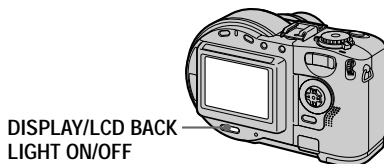

Notes

- You cannot turn off the  (self-timer) indicator and some of the indicators used in advanced operations.
- The indicators on the LCD screen are not recorded.

Using the self-timer

When you use the self-timer function, the subject is recorded about 10 seconds after you press the shutter button.

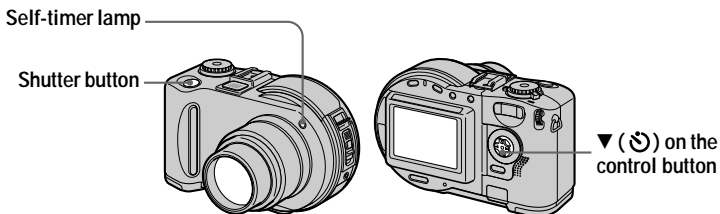

Clear the menu (page 46), then press the control button ▼ (⌚). The ⌚ (self-timer) indicator appears on the LCD screen, and about 10 seconds after you press the shutter button, the subject is recorded. The self-timer lamp flashes and the beep sounds after you press the shutter button until the shutter is released. To cancel the self-timer recording, press the control button ▼ (⌚) again.

Recording images with the flash

The initial setting is AUTO (no indication). In this mode, the flash automatically pops up and strobes if the camera senses that the surroundings become dark. To change the flash mode, clear the menu (page 46), then press ▲ (⚡) on the control button repeatedly so that the flash mode indicator on the LCD screen changes.

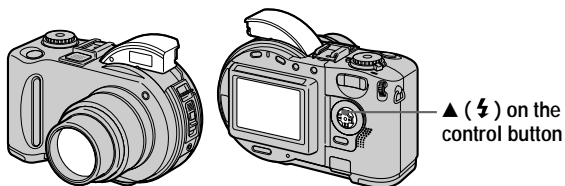

Each time you press the button, the indicator changes as follows.

(No indication) → ⚡ → ⌚ → (No indication)

⚡ Forced flash : The flash strobes regardless of the surrounding brightness.

⌚ No flash : The flash does not strobe.

Pop down the flash by your hand after recording.

You can change the amount of flash light with [⚡ ±] (FLASH LEVEL) in the menu settings (page 50).

To reduce the red-eye phenomenon

Set [RED EYE REDUCTION] to [ON] in the setup settings (page 84), the flash strobes before recording to reduce the red-eye phenomenon. When [ON] is selected,  appears on the LCD screen.

Notes

- When [ISO] is set to [AUTO] in the menu settings (page 49), the recommended shooting distance is 0.3 to 2.5 m (11 7/8 inches to 8 1/3 feet) (MVC-CD200) or 0.3 to 3.0 m (11 7/8 inches to 9 feet 10 1/8 inches) (MVC-CD300). When it is not set to [AUTO], the flash may be ineffective even if the flash level is changed.
- Attaching a conversion lens (optional) may block the light from the flash and the recorded image may be eclipsed.
- You cannot use the built-in flash and an external strobe (optional) at the same time.
- The RED EYE REDUCTION function may not produce the desired red-eye reduction effects depending on individual differences, the distance to the subject, if the subject does not see the pre-strobe, or other conditions.
- Red-eye reduction effects are also difficult to obtain if you select a slow shutter speed in shutter speed priority mode.
- The flash effect is not obtained easily when you use forced flash in a bright location.
- While charging the flash, the /CHG lamp flashes. After the charging is complete, the lamp goes out.
- The flash does not function when recording moving images or recording in EXP BRKTG or BURST mode (MVC-CD300 only) (pages 59, 63).

Recording images with the AF illuminator

The AF illuminator is fill light to focus on a subject easily. Set [AF ILLUMINATOR] to [ON] in the setup settings, ON appears on the LCD screen and the AF illuminator emits light when the shutter button is pressed halfway under dark situations. It keeps emitting light until the focus is locked.

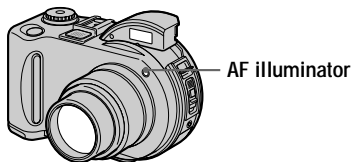

Notes

- If AF illuminator light does not reach the subject sufficiently or the subject has no contrast, focus will not be achieved. Approximate 0.3 to 3.0 m (11 7/8 inches to 9 feet 10 1/8 inches) distance is recommended.
- In TWILIGHT mode of the SCENE SELECTION function (page 58), the AF illuminator will emit only when the flash mode is set to  (Forced flash).
- The AF illuminator will not emit when the LANDSCAPE mode of the SCENE SELECTION function (page 58) is selected or [CONVERSION LENS] is set to [ON] in the setup settings (page 85). ([CONVERSION LENS] is only for MVC-CD300.)
- Focus is achieved as long as AF illuminator light reaches the subject even if its light is slightly out of the middle position of the subject.
- AF illuminator light is safe for persons. However, do not use the AF illuminator with its light emitted directly to person eyes at point-blank range as its light is very strong.
- When using the focus preset function (page 66), you cannot use the AF illuminator.

Recording moving images

Moving images with audio are recorded in MPEG format. Before recording moving images, push the POWER switch in the arrow direction to turn on the power and insert a disc.

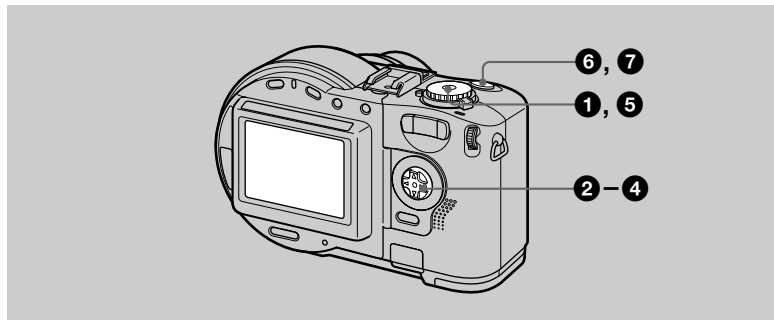

1 Set the mode dial to SET UP.

The setup screen appears.

2 Select [CAMERA] with ▲/▼ on the control button, then press ►.

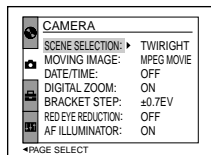

3 Select [MOVING IMAGE] with ▲/▼ on the control button, then press ►.

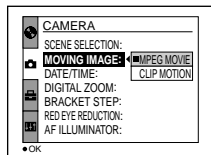

4 Select [MPEG MOVIE] with ▲/▼ on the control button, then press the center ●.

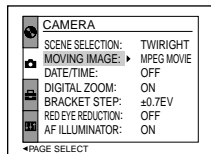

5 Set the mode dial to .

The preparation for recording a moving image is complete.

6 Press the shutter button fully down.

“REC” appears on the LCD screen and the image and sound are recorded on the disc.

7 Press the shutter button fully down again to stop recording.

The recording automatically stops in the following time even if you do not press the shutter button again.

When selecting the 320 (HQ) size: Approximate 15 seconds

When selecting the 320×240 size: Approximate 1 minute

When selecting the 160×112 size: Approximate 4 minutes

For details on the image size, see “Setting the image size (IMAGE SIZE)” on page 53.

Adjusting the brightness of the LCD screen, zooming or using the self-timer

See pages 22 to 24.

The indicators on the LCD screen during recording

Press DISPLAY/LCD BACK LIGHT ON/OFF to turn on/off the indicators on the LCD screen.

These indicators are not recorded. See page 105 for a detailed description of the indicators.

Playing back still images

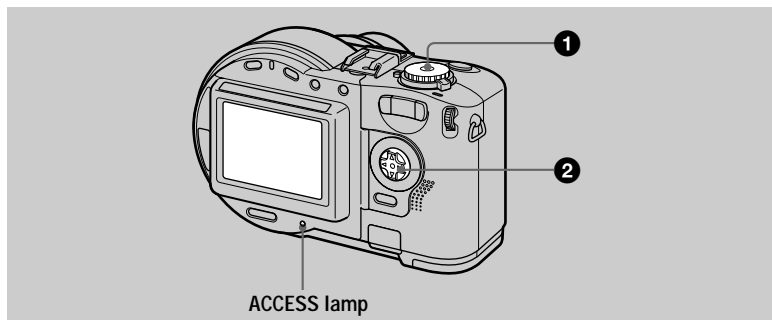

1 Set the mode dial to .

The ACCESS lamp lights and the last recorded image (still or moving) appears on the LCD screen.

2 Select the desired still image with / on the control button.

: To display the preceding image.

: To display the next image.

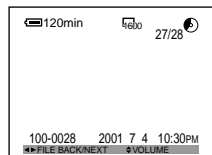

The indicators on the LCD screen during still image playback

Each time you press DISPLAY/LCD BACK LIGHT ON/OFF, the status of the LCD screen changes as follows: all available indicators on → indicators off → LCD backlight off.

See page 106 for a detailed description of the indicators.

Playing back moving images

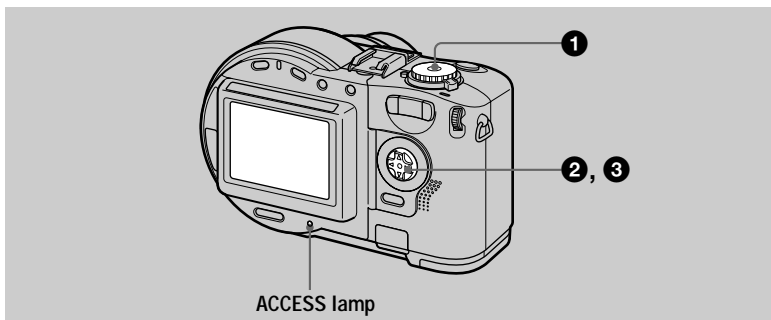



1 Set the mode dial to .

The ACCESS lamp lights and the last recorded image (still or moving) appears on the LCD screen.

2 Select the desired moving image with on the control button.

Moving images are displayed one size smaller than still images except when you shot at the 320 (HQ) (page 53) size.

: To display the preceding image.

: To display the next image.

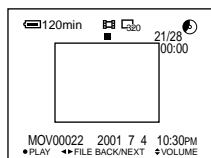

3 Press the center on the control button to start the playback.

The moving image and sound are played back.

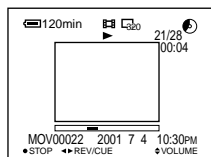

During playback,  (playback) appears on the LCD screen.



To stop the playback

Press the center  on the control button to stop the playback.

To advance or rewind the moving image

Press   on the control button during playback. To return to the normal playback, press the center .

Moving images recorded with the image of [320 (HQ)] (page 54)

The images are displayed over the entire screen in steps 2 and 3.

Adjusting the volume

Press ▲/▼ on the control button to adjust the volume.



The indicators on the LCD screen during moving image playback

Each time you press DISPLAY/LCD BACK LIGHT ON/OFF, the status of the LCD screen changes as follows: all available indicators on → indicators off → LCD backlight off.

See page 107 for a detailed description of the indicators.

Preparation for viewing images using a computer

Using the supplied 8 cm CD adaptor

When your disc drive does not conform to 8 cm CD, use the supplied 8 cm CD adaptor.

- 1 Slide the disc into the inner groove and under two of the tabs on the inner circle of adaptor in the numbered order.**

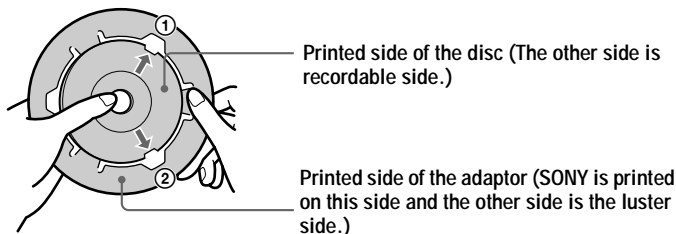

- 2 Pull the third tab out away from the disc and the disc will slip into place. Release the third tab and the disc will be held firmly in place.**

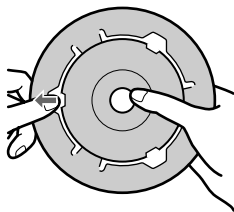

- 3** Check that the disc is set correctly in the grooves of the adaptor, that all the tabs are even with the surface of the adaptor, and that the disc is not protrude from the adaptor.

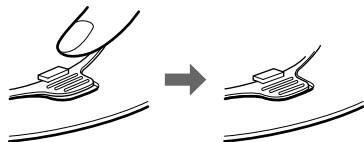
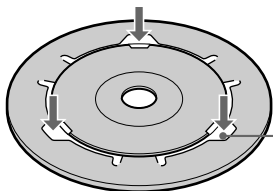

If the tabs protrude, press them back down into place. Otherwise, it may cause malfunction of your disc drive.

Notes

- The supplied adaptor may not be used with your disc drive. For details, refer to the operating instructions of the disc drive.
- Use the adaptor at a low-speed (8-speed or lower).
- Do not place the adaptor under direct sunlight or near the heat.
- The adaptor is only used with Mavica discs. This cannot be used with other 8 cm CD-Rs/CD-RWs.

Preparing for viewing images on CD-ROM drives (FINALIZE)

You can play back the disc recorded with this camera on CD-ROM drives. You have to execute the finalization before viewing images on a CD-ROM drive. A disc that has not been executed the finalization cannot be read with CD-ROM drives.

What is finalization?

- The finalization is required to view images on a CD-ROM drive.
- You can record new images on the finalized disc if you execute the initialization on it again. The initialization will be automatically executed when the finalization is executed using the camera. You have to execute the finalization to view new images on a CD-ROM drive. Each time you execute the finalization, approximate 13 MB of the disc will decrease. We recommend that you execute the finalization onto compiled data at a time.
- You can execute the finalization onto the disc later, even if you remove it from the camera.
- The CD-ROM drive must conform to the MultiRead type to read the disc that was finalized.

Executing the finalization

- 1 Set the mode dial to SET UP.**
The setup screen appears on the LCD screen.

- 2 Select [DISC TOOL] with ▲/▼ on the control button, then press ►.**

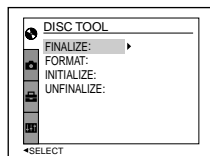

- 3 Select [FINALIZE] with ▲/▼ on the control button, then press ►.**

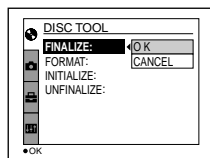



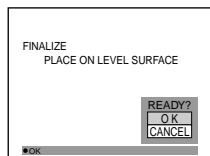

- 4 Select [OK] with ▲ on the control button, then press ●.**

“FINALIZE PLACE ON LEVEL SURFACE” appears on the LCD screen. Be sure to avoid any vibration during the finalization.



- 5 Select [OK] with ▲ on the control button, then press ●.**

Finalization starts and the disc remaining indicator changes from  to , or from  to .

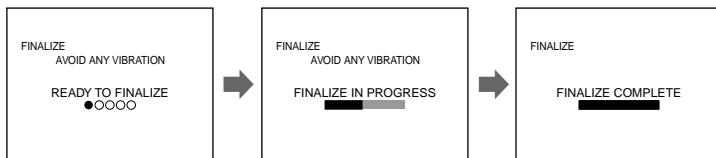

To cancel the finalization



Select [CANCEL] with ▼ on the control button in step **4** or **5**, then press the center ●. Once the finalization starts, you cannot cancel it.

Notes





- It takes for about one minute to execute the finalization. Do not shake or jar the camera during this operation. Place the camera on a stable surface during the finalization.
- When you execute the finalization, we recommend that you use the external power source (page 13).

Canceling the finalization (UNFINALIZE) (only for CD-RWs)

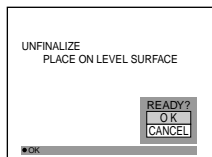
When using CD-RWs, you can cancel the last-executed finalization. Once you cancel it, the disc space for executing the finalization is recovered.



- 1** Set the mode dial to the , **S, A, M, SCN**, or .
“UNFINALIZE PLACE ON LEVEL SURFACE” appears on the LCD screen. Be sure to avoid any vibration during the unfinalization.

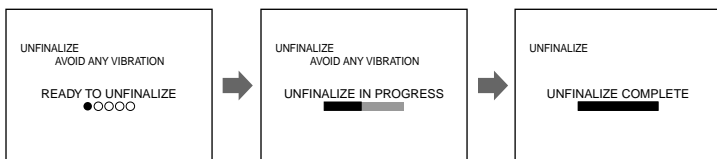

- 2** Select [OK] with  on the control button, then press .
Unfinalization starts and the disc remaining indicator changes from  to .



To cancel the unfinalization

Select [CANCEL] with  on the control button in step **2**, then press the center .
When it is canceled, you can continuously record an image on the CD-RW.

To unfinalize after canceling the unfinalization

Set the mode dial to SET UP, then execute [UNFINALIZE] from [] (DISC TOOL) in the setup settings (page 84).

Notes

- Unfinalization cannot be executed when you record a new image or edit an image on the CD-RW after executing the finalization.
- It takes about one minute to execute the unfinalization. Do not shake or jar the camera during this operation. Place the camera on a stable surface during the unfinalization.

Tip

You can also execute the unfinalization using [] (DISC TOOL) in the setup settings (page 84).

Viewing images using a computer

You can view data recorded with your camera on a computer. This section describes the general method for viewing images on a computer and installing the driver into a computer. Be sure to also see the operation manuals for your computer and application software. To view images on the CD-RW using a CD-ROM drive or CD-R drive, the drive must conform to the MultiRead type. Whether your drive conforms to the MultiRead type or not, consult the drive manufacturer.

<<Recommended Windows environment>>

You can view images on a Windows computer in the following three ways, **A**, **B**, and **C**. Check the computer environment below, then follow the procedures described on pages 37 to 42.

A Viewing images with a CD-ROM drive (page 37)

Finalize the disc beforehand (page 32).

OS:Microsoft Windows 98, Windows 98SE, Windows Me, Windows 2000 Professional

The above OS is required to be installed at the factory.

Operation is not assured in an environment upgraded to the operating systems described above.

B Viewing images with a computer connected with the USB cable (page 38)

There are two ways to make the USB connection, which are the normal connection and the PTP connection (page 86). This is set using [USB CONNECT] in the setup settings. However, any OS does not conform to [PTP] as of February 2001. Here describes the way using the [NORMAL] setting.

You do not need to finalize the disc. You have to install the USB driver and the software, DirectCD included in the supplied CD-ROM. For details on DirectCD, refer to the software operating instructions of DirectCD.

OS:Microsoft Windows 98, Windows 98SE, Windows Me, Windows 2000 Professional

The above OS is required to be installed at the factory.

Operation is not assured in an environment upgraded to the operating systems described above.

CPU:MMX Pentium 200 MHz or faster

The USB connector must be provided as standard.

The CD-ROM drive is required for installing the USB driver.

Notes

- Operations are not guaranteed if you connect two or more USB equipment to a single computer at the same time (except for the USB keyboard and mouse which are provided as standard), or when using a hub.
- Depending on the type of USB equipment that is used simultaneously, some equipment may not operate.
- Operations are not guaranteed for all the recommended computer environments mentioned above.

C Viewing images with a CD-R/CD-RW drive (page 41)

You do not need to finalize the disc. You have to install the software, DirectCD included in the supplied CD-ROM. For details on Windows environment, refer to the software operating instructions of DirectCD.

<<Recommended Macintosh environment>>

You cannot view images on a Macintosh computer by USB connection.

Install the driver, Adaptec UDF Volume Access included in the supplied CD-ROM into your computer and finalize the disc to view images.

Macintosh computer with the Mac OS 8.5.1/8.6/9.0 standard installation
QuickTime 3.0 or later must be installed.

Note

Operations are not guaranteed for all the recommended computer environments mentioned above.

Notes on using your computer

Software

- Data recorded with your camera is stored in the following formats. Make sure that applications that support these file formats are installed on your computer.
 - Still image (except TEXT mode, uncompressed mode and Clip Motion): JPEG format
 - Moving image/Voice memo: MPEG format
 - Uncompressed mode still image: TIFF mode
 - TEXT mode/Clip Motion: GIF format.
- Depending on your application software, the file size may increase when you open a still image file.
- When you copy the image to the camera from your computer, which was modified with a retouching software and was converted to another file format, the “FILE ERROR” message may appear and you may be unable to open the image.
- Depending on your application software, only the first frame of the Clip Motion file may be played back.

Communications with your computer (for Windows only)

Communications between your camera and your computer may not recover after recovering from Suspend or Sleep.

- Windows and ActiveMovie, DirectShow are either registered trademarks or trademarks of Microsoft Corporation in the United States and /or other countries.
- Macintosh and Mac OS, QuickTime are either registered trademarks or trademarks of Apple Computer, Inc.
- DirectCD is a trademark of Adaptec, Inc.
- All other product names mentioned herein may be the trademarks or registered trademarks of their respective companies. Furthermore, “™” and “®” are not mentioned in each case in this manual.

Viewing images on a Windows computer

When playing back moving images, Real Player or Windows Media Player must be installed into your computer.

A Viewing images with a CD-ROM drive

Finalize the disc beforehand (page 32).

E.g., for Windows Me users

- 1 Start up your computer and insert the disc into the CD-ROM drive of your computer.**
- 2 Open [My Computer] and double click the drive recognizing the disc (Example:[CD-ROM (D:)]).**
- 3 Double-click the desired data file.**
For the detailed folder and file names, see “Image file storage destinations and image file names” (page 43).

Desired file type	Double-click in this order
Still image	“DCIM” folder → “100MSDCF” folder → Image file
Moving image*	“MSSONY” folder → “MOML0001” folder → Image file
Audio*	“MSSONY” folder → “MOMLV100” folder → Audio file
Clip Motion image	“DCIM” folder → “100MSDCF” folder → Image file
E-mail image Tiff image (uncompressed)	“MSSONY” folder → “IMCIF100” folder → Image file

* Copying a file to the hard disk of your computer before viewing is recommended. If you play back the file directly from the disc, the image and sound may break off.

B Viewing images with a computer connected with the USB cable

Once you install DirectCD included in the supplied CD-ROM, you do not need to finalize the disc to view images on the disc.

You can exchange data between the camera and a computer using the supplied USB cable and CD-ROMs.

Installing the USB driver

Do not connect the camera to the computer yet.

Before connecting your camera to your computer, install the USB driver to the computer. The USB driver is contained in the supplied CD-ROM (SPVD-006).

If the drive is not recognized, see “Troubleshooting” on page 93.

E.g., for Windows Me users

-
- 1 Turn on your computer and allow Windows to load.**
Do not connect the USB cable in this step.

 - 2 Insert the supplied CD-ROM (SPVD-006) in the CD-ROM drive of your computer**
If the setup screen of DirectCD appears, click [Exit] on the screen.

 - 3 Open [My Computer] on Windows and right-click the CD-ROM drive (Example: CD-ROM (D:)), then select [Open (O)].**
The file list of the CD-ROM appears. If other application software works, quit the application software.

 - 4 Double-click the [SONY USB] folder in the file list, and then double-click [SET UP].**
The installer of device driver starts and the necessary files are automatically copied to the computer.

 - 5 Restart the computer.**
If the message appears after the installation to verify that you restart the computer, restart the computer. In other cases, restart it manually.

 - 6 Prepare the camera before connecting the computer.**
 - Connect the AC power adaptor to the camera.
 - Turn on the camera.
-

- 7** Connect the USB jack on your camera with the USB connector on your computer using the supplied USB cable.

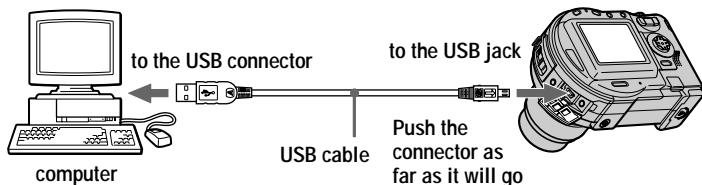

- 8** The computer automatically recognizes the camera. Open [My Computer], the newly recognized drive (Example: (E:)) is added. Installing driver is complete.
- 9** Insert the disc into the camera, connect the AC power adaptor to the camera, then turn on the power of the camera. Go to "Viewing images" below. If you remove the disc without viewing an image, be sure to read "Before disconnecting the USB cable" on page 40.

Viewing images

When you view images on the disc which was not finalized, you have to install DirectCD included in the supplied CD-ROM. For details on DirectCD, refer to the software operating instructions of DirectCD.

E.g., for Windows Me users

- 1** Turn on your computer and allow Windows to load.
- 2** Connect the USB jack on your camera with the USB connector on your computer using the supplied USB cable.

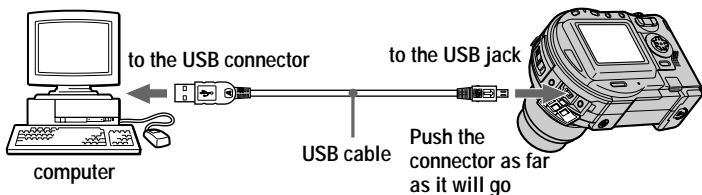

- 3** Insert the disc into the camera, connect the AC power adaptor to the camera, then turn on the power of the camera. "USB MODE" appears on the LCD screen of the camera.

4 Open [ My Computer] on Windows and double-click the newly recognized drive. (Example: [ CD Mavica (E:)])

The folders inside the disc are displayed, and the disc cover of the camera will be locked. To remove the disc, carry out the operation for removing the disc described on the software operating instructions of DirectCD.

If the drive is not recognized, see “Troubleshooting” on page 93.

5 Select and double-click the desired image/sound file from the folder.

For the detailed folder and file names, see “Image file storage destinations and image file names” (page 43).

Desired file type	Double-click in this order
Still image	“DCIM” folder → “100MSDCF” folder → Image file
Moving image*	“MSSONY” folder → “MOMLV001” folder → Image file
Audio*	“MSSONY” folder → “MOMLV100” folder → Audio file
Clip Motion image	“DCIM” folder → “100MSDCF” folder → Image file
E-mail image Tiff image (uncompressed)	“MSSONY” folder → “IMCIF100” folder → Image file

* Copying a file to the hard disk of your computer before viewing is recommended. If you play back the file directly from the disc, the image and sound may break off.

Before you remove the disc, be sure to read “Before disconnecting the USB cable” on page 40.

Copying a file in the disc to a computer

Select the desired file, and drag it to the desired drive or folder.

Copying a file in a computer to a disc

Once you install DirectCD included in the supplied CD-ROM into your computer, you can drag and drop the desired file to the disc. To view the image using this camera, the file name format must be as follows, “DSC0□□□□.JPG”.

For details, see “Image file storage destinations and image file names” (page 43).

Before disconnecting the USB cable

Before disconnecting the USB cable, you must carry out the operation for removing the disc. This operation is described in “Removing the disc” of the software operating instructions of DirectCD.

The data in the disc may be broken if you do not carry out this operation. Refer to the procedure below.

1 Remove the disc.

For details, refer to the software operating instructions of DirectCD.

2 When using Windows Me, Windows 2000 Professional:

- ① Select the applicable drive from [] on the task bar, then stop it.
- ② After the message informing you that the drive has been removed safely appears, disconnect the USB cable.

When using other operating systems than above:

Simply, disconnect the USB cable.

C Viewing images using a CD-R/CD-RW drive

You do not need to finalize the disc. You have to install DirectCD included in the supplied CD-ROM. For details on DirectCD, refer to the software operating instructions of DirectCD.

Viewing images on a Macintosh computer

Viewing images with a CD-ROM drive

Finalize the disc beforehand (page 32). You have to install the driver, Adaptec UDF Volume Access included in the supplied CD-ROM (SPVD-006).

- ① Start up your computer and allow the Mac OS to load.
- ② Insert the supplied CD-ROM (SPVD-006) in the CD-ROM drive of your computer.
- ③ Double-click the CD-ROM drive icon to open the window.
- ④ Double-click the icon of the hard disk containing the OS to open the window.
- ⑤ Move the driver, “Adaptec UDF Volume Access” from the window opened in step ③ to the “System Folder” folder in the window opened in step ④ (drag and drop).
- ⑥ When “Put these items into the Extensions folder?” appears, click “OK.”
- ⑦ Restart your computer.

Viewing images

- ① Start up your computer and insert the disc into the CD-ROM drive of your computer.

2 Double click the disc folder.

3 Double-click the desired data file.

For the detailed folder and file names, see “Image file storage destinations and image file names” (page 43).

Desired file type	Double-click in this order
Still image	“DCIM” folder → “100MSDCF” folder → Image file
Moving image*	“MSSONY” folder → “MOML0001” folder → Image file
Audio*	“MSSONY” folder → “MOMLV100” folder → Audio file
Clip Motion image	“DCIM” folder → “100MSDCF” folder → Image file
E-mail image Tiff image (uncompressed)	“MSSONY” folder → “IMCIF100” folder → Image file

* Copying a file to the hard disk of your computer before viewing is recommended. If you play back the file directly from the disc, the image and sound may break off.

Image file storage destinations and image file names

Image files recorded with your camera are grouped in folders by recording mode. The meanings of the file names are as follows. □□□□ stands for any number within the range from 0001 to 9999.

E.g., for Windows Me users (The drive recognizing the camera is "E.")

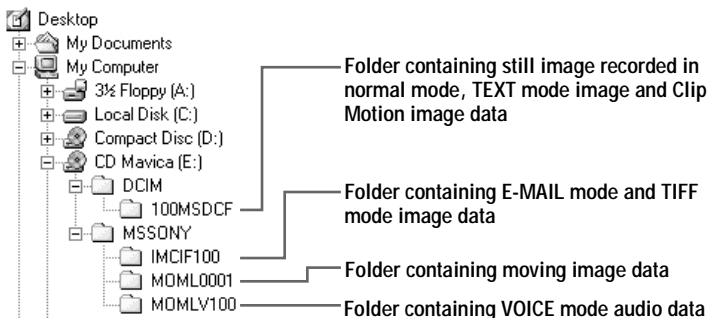

Folder	File	Meaning
100MSDCF	DSC0□□□□.JPG	<ul style="list-style-type: none"> • Still image file recorded normally • Still image file recorded in <ul style="list-style-type: none"> — E-MAIL mode (page 59) — TIFF mode (page 62) — VOICE mode (page 60)
	CLP0□□□□.GIF	• Clip Motion file recorded in NORMAL mode (page 64)
	CLP0□□□□.THM	• Index image file of Clip Motion file recorded in NORMAL mode
	MBL0□□□□.GIF	• Clip Motion file recorded in MOBILE mode (page 64)
	MBL0□□□□.THM	• Index image file of Clip Motion file recorded in MOBILE mode
	TXT0□□□□.GIF	• Still image file recorded in TEXT mode (page 61)
	TXT0□□□□.THM	• Index image file of still image file recorded in TEXT mode

Folder	File	Meaning
IMCIF100	DSC0□□□□.JPG	• Small-size image file recorded in E-MAIL mode (page 59)
	DSC0□□□□.TIF	• Uncompressed image file recorded in TIFF mode (page 62)
MOML0001	MOV0□□□□.MPG	• Moving image file recorded normally
MOMLV100	DSC0□□□□.MPG	• Audio file recorded in VOICE mode (page 60)

The numerical portions of the following files are the same.

- A small-size image file recorded in E-MAIL mode and its corresponding image file
- An uncompressed image file recorded in TIFF mode and its corresponding image file
- An audio file recorded in VOICE mode and its corresponding image file
- An image file recorded in TEXT mode and its corresponding index image file
- An image file recorded with Clip Motion and its corresponding index image file

Tip

The digital still camera saves recorded images as digital data. The format of the saved data is called as the file format. The formats that can be used with this camera are as follows:

JPEG format

Most digital still cameras, operating systems of computers, and browser software adopt this format. This format is able to compress files without appreciable deterioration. However, if the image is compressed and saved on repeated occasions, the image will deteriorate. This camera records still images using the JPEG format for normal recording.

GIF format

Using this format, the image will not deteriorate even if the image is compressed and saved on repeated occasions. This format limits the number of colors to 256 colors. This camera records still images using the GIF format in Clip Motion (page 64) or TEXT mode (page 61).

TIFF format

Stores shooting images without compression, so the image does not deteriorate. Most of operating systems and applications correspond to this format. This camera records still images using the TIFF format for the TIFF mode (page 62).

MPEG format

This format is very typical for moving images. This camera records audio using the MPEG format for the moving images recording and the VOICE mode (page 60).



Before performing advanced operations

This section describes the basic control methods that are frequently used for “Advanced operations.”

How to use the mode dial

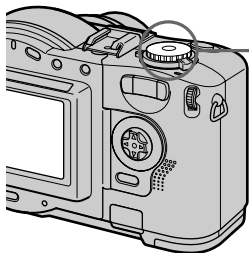
The mode dial switches the function which is used for recording, playback, or editing. The SET UP position changes the settings of infrequently-used items (page 84). Set the dial as follows before starting to operate your camera.



-  : To record still images, VOICE memos
- S:** To record in the shutter speed priority mode
- A:** To record in the aperture priority mode
- M:** To record with the shutter speed and aperture set manually
- SCN:** To record in the SCENE SELECTION mode
- SET UP:** To display the setup items
-  : To record moving images or Clip Motion images
-  : To play back or edit images

How to use the control button

When the menu or setup screen is displayed, the control button is used to select the buttons, images and menu items displayed on the LCD screen of your camera and modify the settings. The operation methods that are frequently used for “Advanced operations” are described below.

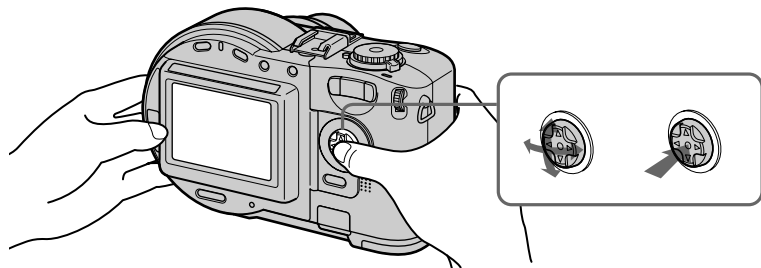

Turning on/off the operation buttons (menu) on the LCD screen

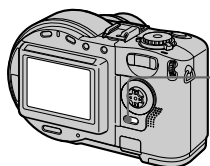

Press MENU to display/clear the menu on the LCD screen.

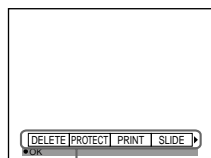





Menu

Setting up the items in the setup or menu



- 1 Set the mode dial to SET UP so that the setup screen appears, or press MENU so that the menu appears.



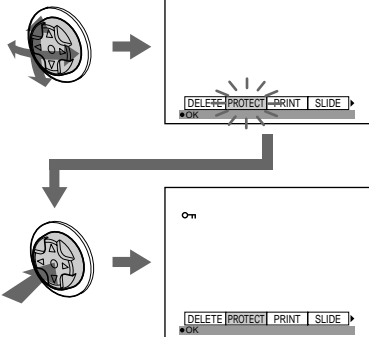

2 When the mode dial is set to SET UP or :

- 1 Press /// on the control button to select the item or setting you want to set up. The selected setting turns yellow.
- 2 Press the center  to enter the item.

Example: 



When the mode dial is set to , S, A, M, SCN, or :

Press /// on the control button to select the setting of the item. The selected setting turns yellow, and the setup is complete.

Example: 



How to use the jog dial

The functions which are used frequently are set up using the jog dial and the following direct buttons. The jog dial is used to change the value in manual adjustments.

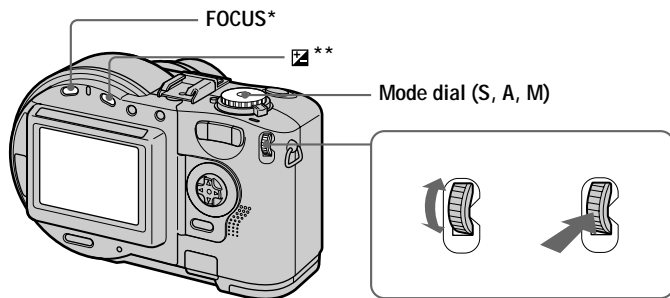

* This button is available when the mode dial is set to , S, A, M, SCN, or .

** This button is available when the mode dial is set to , S, A, SCN, or .

1 Press FOCUS or , or set the mode dial to S, A, or M.

2 Turn the jog dial to select the item or value number you want to adjust.

- When the indication ◀ at the right end on the LCD screen is in yellow, you can select the item. In such cases, go to step **3**.



Yellow

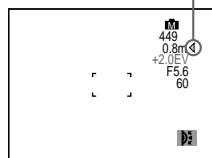

- When the value number at the right end on the LCD screen is in yellow, you can adjust the value. (When you press FOCUS, the mark appears on value number position.)
When you adjust only the value, the adjustment is complete.

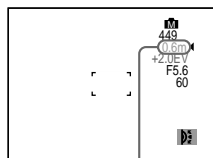

Yellow

3 Press the jog dial.

The value number turns to yellow. To adjust the value, repeat step

2.



Viewing the next/previous image using the jog dial during playback



When viewing an image in single-image mode (page 72), you can easily view the next/previous image by turning the jog dial.

Menu settings

Menu items that can be modified differ depending on the positions of the mode dial. The LCD screen shows only the items you can operate at the moment. Initial settings are indicated with ■.

When the mode dial is set to /S/A/M/SCN

Item	Setting	Description
WB (WHITE BAL)	ONE PUSH ■ AUTO IN DOOR OUT DOOR	Sets the white balance (page 68).
ISO	400 200 100 ■ AUTO	Selects the ISO film speed. When recording under dark situations or recording a fast-moving subject, use a high-number setting. When you record high-quality images, use a low-number setting (except when the mode dial is set to SCN).
 (IMAGE SIZE)	MVC-CD200 ■ 1600×1200 1600 (3:2) 1024×768 640×480 MVC-CD300 ■ 2048×1536 2048 (3:2) 1600×1200 1280×960 640×480	Selects the image size when recording still images (page 53).





Item	Setting	Description
 (P. QUALITY)	<input checked="" type="checkbox"/> FINE STANDARD	Records still images in the fine image quality mode. Records still images in the standard image quality mode.
	MODE (REC MODE) TIFF TEXT VOICE E-MAIL EXP BRKTG (MVC-CD300 only) BURST (MVC-CD300 only) <input checked="" type="checkbox"/> NORMAL	Records a TIFF (uncompressed) file in addition to the JPEG file (page 62). Records a GIF file in black-and-white (page 61). Records an audio file (with a still image) in addition to the JPEG file (page 60). Records a small-size (320×240) JPEG file in addition to the selected image size (page 59). Records three images with the exposure value of each image shifted a little (page 63). Records three images continuously (page 59). Records an image using the normal recording mode.
 (FLASH LEVEL)	<input type="checkbox"/> HIGH <input checked="" type="checkbox"/> NORMAL <input type="checkbox"/> LOW	Makes the flash level higher than normal. Normal setting. Makes the flash level lower than normal.
PFX (P. EFFECT)	SOLARIZE B&W SEPIA NEG.ART <input checked="" type="checkbox"/> OFF	Sets the image special effects (page 69).
<input type="checkbox"/> (SHARPNESS)	+2 to -2	Adjusts the sharpness of the image. The <input type="checkbox"/> indicator appears (except when the setting is 0).

When the mode dial is set to  ([MOVING IMAGE] is set to [MPEG MOVIE] in the setup settings.)

Item	Setting	Description
WB (WHITE BAL)	ONE PUSH <input checked="" type="checkbox"/> AUTO IN DOOR OUT DOOR	Sets the white balance (page 68).
 (IMAGE SIZE)	320 (HQ) 320×240 <input checked="" type="checkbox"/> 160×112	Selects the MPEG image size when recording moving images (page 53).



Item	Setting	Description
PFX (P. EFFECT)	SOLARIZE B&W SEPIA NEG.ART ■ OFF	Sets the image special effects (page 69).

When the mode dial is set to  ([MOVING IMAGE] is set to [CLIP MOTION] in the setup settings.)

Item	Setting	Description
WB (WHITE BAL)	ONE PUSH ■ AUTO IN DOOR OUT DOOR	Sets the white balance (page 68).
 (IMAGE SIZE)	■ NORMAL MOBILE	Selects the Clip Motion image size (page 53).
 ± (FLASH LEVEL)	HIGH ■ NORMAL LOW	Makes the flash level higher than normal. Normal setting. Makes the flash level lower than normal.
PFX (P. EFFECT)	SOLARIZE B&W SEPIA NEG.ART ■ OFF	Sets the image special effects (page 69).
 (SHARPNESS)	+2 to -2	Adjusts the sharpness of the image. The  indicator appears (except when the setting is 0).

When the mode dial is set to 

Item	Setting	Description
DELETE	OK CANCEL	Deletes the displayed image (page 77). Cancels deleting of the image.
PROTECT	–	Protects images against accidental erasure (page 78).
PRINT	–	Marks the print mark on still images (page 81).

Item	Setting	Description
SLIDE*	INTERVAL REPEAT START CANCEL	Sets the slide show interval. ■ 5 sec/10 sec/30 sec/1 min A slide show can be repeated for up to approx. 20 minutes. ■ ON/OFF Starts the slide show. Cancels the slide show.
RESIZE*	MVC-CD200 1600×1200 1024×768 640×480 CANCEL MVC-CD300 2048×1536 1600×1200 1280×960 640×480 CANCEL	Changes the recorded image size (page 80).
ROTATE*	  OK CANCEL	Rotates the still image (page 75).

* Only in single-image mode.

Setting the image size (IMAGE SIZE)

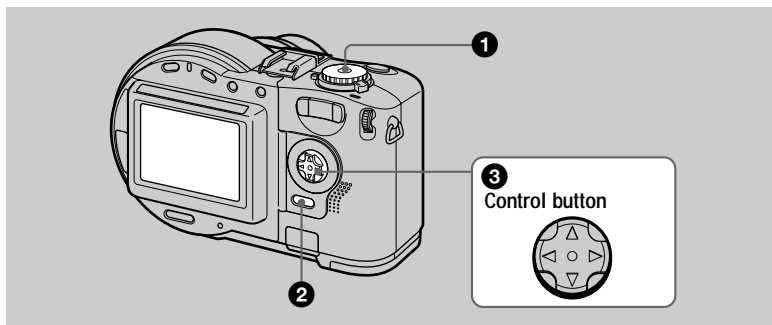

- 1** Set the mode dial to , S, A, M, SCN, or .
- 2** Press MENU.
The menu appears.
- 3** Select the desired image size with / on the control button from (IMAGE SIZE).

Still image sizes:

MVC-CD200: 1600×1200, 1600 (3:2)*, 1024×768, 640×480

MVC-CD300: 2048×1536, 2048 (3:2)*, 1600×1200, 1280×960, 640×480

* The image is recorded in the ratio of three to two to fit the printing paper size. Using this image size, the margin of an image is not printed out. However, the slight amount of the upper and lower black portions are displayed on the LCD screen.

Moving image (MPEG movie) sizes:

320 (HQ)*, 320×240, 160×112

* High Quality mode

Moving image (Clip Motion) sizes:

MOBILE (80×72), NORMAL (160×120)

The number of images* or the time** that you can record on a disc

MVC-CD200

Image size	Quality	
	STANDARD	FINE
1600×1200	Approx. 237	Approx. 132
1600 (3:2)	Approx. 237	Approx. 132
1024×768	Approx. 500	Approx. 321
640×480	Approx. 1300	Approx. 663
320 (HQ)	Approx. 355 (15) sec **	
320×240	Approx. 1420 (60) sec **	
160×112	Approx. 5400 (240) sec **	
MOBILE	Approx. 1430	
NORMAL	Approx. 560	

MVC-CD300

Image size	Quality	
	STANDARD	FINE
2048×1536	Approx. 147	Approx. 81
2048 (3:2)	Approx. 147	Approx. 81
1600×1200	Approx. 237	Approx. 132
1280×960	Approx. 349	Approx. 197
640×480	Approx. 1300	Approx. 663
320 (HQ)	Approx. 355 (15) sec **	
320×240	Approx. 1420 (60) sec **	
160×112	Approx. 5400 (240) sec **	
MOBILE	Approx. 1430	
NORMAL	Approx. 560	

* When MODE (REC MODE) is set to NORMAL.

** The numbers in parentheses indicate the maximum recording time in continuous recording

Note

The number of images recordable on a disc may decrease depending on conditions.

Tip

The size of the image is indicated by the pixel unit. The higher the number of pixels, the more information is included. So, an image that is saved using a large number of pixels is suitable for a large-format print and one that is saved using a smaller number of pixels is suitable for attaching to an E-mail. Normally, an image is recorded in the ratio of four to three to fit the monitor ratio. This camera can also record the image in the ratio of three to two to accommodate the most common printing paper size. This is the same ratio as the one used in photo-developing shops.



2048×1536



2048 (3:2)

► Various recording

Recording with the exposure fixed (AE LOCK)

Mode dial: /S/A/SCN

Once you press AE LOCK, the exposure, now captured, is fixed. For instance, this function is convenient in the following use:

Measure the exposure of the desired portion of the subject using the spot light-metering function and fix its exposure value by pressing AE LOCK. Then, recompose the picture.

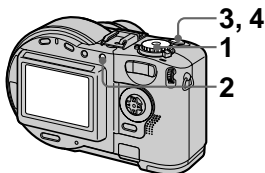

- 1 Set the mode dial to , S, A, or SCN.**
- 2 Target the subject that has desired exposure value, then press AE LOCK.**
The exposure is fixed and the AE-L mark appears.
- 3 Target the subject you want to record and press and hold the shutter button halfway down.**
The focus is automatically adjusted.
- 4 Press down the shutter button.**

To release AE LOCK

Carry out one of the followings:

- Press AE LOCK again after step **2**.
- Release your finger from the shutter button after step **3**.
- Press down the shutter button in step **4**.

Recording with the manual adjustments

Mode dial: S/A/M

Shutter speed priority mode

Once the shutter speed is adjusted manually, the aperture will be automatically adjusted to the suitable value to attain correct exposure according to the brightness of the subject. Using the higher shutter speed, you can record a fast-moving subject with its motion frozen. And using the lower shutter speed, you can record the flow motion of a moving subject.



- 1 Set the mode dial to S.**
- 2 Select a shutter speed with the jog dial, then press the jog dial.**

The shutter speed can be selected from 8" to 1/800 (MVC-CD200) or 8" to 1/1000 (MVC-CD300) by 1/3 step.

Aperture priority mode

Once the aperture is adjusted manually, the shutter speed will be automatically adjusted to the suitable value to attain correct exposure according to the brightness of the subject. As selecting a narrow aperture, the lens iris opens. Using a narrow aperture, you can record a subject with its background unclear. And using a wide aperture, you can record both the subject and the background stand out clearly.



- 1 Set the mode dial to A.**
- 2 Select an aperture value with the jog dial, then press the jog dial.**

The aperture value can be selected from F2.8 to F11 (MVC-CD200) or from F2 to F8 (MVC-CD300) by 1/3 step.

Manual exposure mode

You can manually adjust the shutter speed and aperture values to achieve the desired shooting condition according to your purpose. The exposure value appears on the LCD screen (page 67). And you can also adjust this value according to your taste. 0 EV is the most suitable value set by the camera.

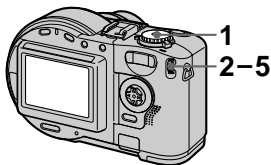

Note

If the setting is not appropriate in aperture priority mode, shutter speed priority mode, or manual exposure mode, the setting value indicator on the LCD screen flashes when the shutter button is pressed halfway down. You can record in this setting, we, however, recommend that you adjust the flashed-value again.

1 Set the mode dial to M.

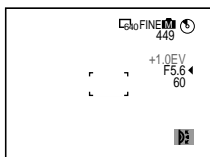

- 2 Select the aperture value indication with the jog dial, then press the jog dial.
- 3 Select the aperture value with the jog dial, then press the jog dial.
- 4 Select the shutter speed value indication with the jog dial, then press the jog dial.
- 5 Select the shutter speed value with the jog dial.

For details on available values, see “Shutter speed priority mode” on page 56, or “Aperture priority mode” on page 56.

Recording images according to shooting conditions (SCENE SELECTION)

Mode dial: SCN

This camera has preset three SCENE SELECTION modes. Each mode is suitable for the following situations; night scene, landscape, and portrait.

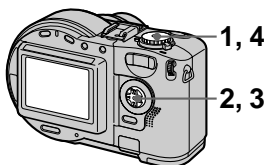

- 1 Set the mode dial to SET UP.**
The setup screen appears.
- 2 Select [] (CAMERA) with ▲/▼, [SCENE SELECTION] with ►/▲/▼, then press ►.**
- 3 Select the desired setting, then press ●.**

🌙 TWILIGHT mode

You can record the subject without losing the dark atmosphere of the surroundings. We recommend that you use a tripod to prevent camera-shake as the shutter speed is set slow in this mode.

🏞️ LANDSCAPE mode



Focuses only on a distant subject to record landscapes, etc.

👤 PORTRAIT mode



Suits for portrait recordings. Backgrounds blurred away, and the frontward person is sharpened.

- 4 Set the mode dial to SCN.**
The selected setting is loaded.

To cancel the SCENE SELECTION function

Set the mode dial to , S, A, M, SET UP, , or .

Notes

- You can focus only on distant subjects in LANDSCAPE mode.
- Set the forced flash  when you use the flash in the following modes:
 - TWILIGHT mode
 - LANDSCAPE mode
- When using the SCENE SELECTION mode, the AF illuminator (page 25) does not emit in the following conditions:
 - TWILIGHT mode: when the flash mode is not set to the  forced flash mode
 - LANDSCAPE mode: you cannot use the AF illuminator.

Tip

Under normal recording conditions, the camera automatically makes various adjustments, such as those for the focus, iris, exposure, and white balance, as it shoots. However, you may not be able to carry out your desired shooting depending on shooting conditions. The SCENE SELECTION function provides you with near-optimum adjustments to suit your shooting situation.

Recording three images continuously (BURST) (only for MVC-CD300)

Mode dial: /S/A/M/SCN

This mode is used for a continuous recording. Press the shutter button in this mode, the camera records three images continuously.

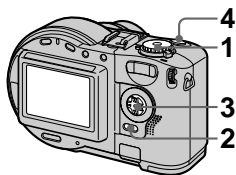

- 1 Set the mode dial to , S, A, M, or SCN.
- 2 Press MENU.
The menu appears.
- 3 Select [MODE] (REC MODE) with , [BURST] with .
- 4 Record the image.

To return to normal recording mode

Select [NORMAL] with in step 3.

Notes

- You cannot use the flash in this mode.
- During recording in this mode, the image is not displayed on the LCD screen. Make the composition before pressing the shutter button.
- The recording interval is approximate 0.6 second.
- The shutter speed more than 1" cannot be selected in BURST mode.

Recording still images for e-mail (E-MAIL)

Mode dial: /S/A/M/SCN

In the E-MAIL mode, a small-size image which is suitable for e-mail transmission is also recorded at the same time as recording a normal still image. (The size of the normal still image is set using (IMAGE SIZE) in the menu settings (page 53).)

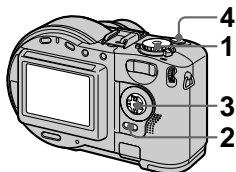

- 1 Set the mode dial to , S, A, M, or SCN.
- 2 Press MENU.
The menu appears.
- 3 Select [MODE] (REC MODE) with , [E-MAIL] with .
- 4 Record the image.

The number of images that you can record on a disc in E-MAIL mode

MVC-CD200

Image size	Quality	
	STANDARD	FINE
1600×1200	Approx. 216	Approx. 126
1600 (3:2)	Approx. 216	Approx. 126
1024×768	Approx. 416	Approx. 285
640×480	Approx. 855	Approx. 524

MVC-CD300

Image size	Quality	
	STANDARD	FINE
2048×1536	Approx. 138	Approx. 79
2048 (3:2)	Approx. 138	Approx. 79
1600×1200	Approx. 216	Approx. 126
1280×960	Approx. 306	Approx. 182
640×480	Approx. 855	Approx. 524

To return to normal recording mode

Select [NORMAL] with ▲/▼ in step 3.

Adding audio files to still images (VOICE)

Mode dial:  /S/A/M/SCN

In the VOICE mode, the audio is also recorded at the same time as recording a still image. You can vividly record the situation with audio.

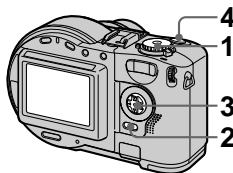

- 1 Set the mode dial to , S, A, M, or SCN.**
- 2 Press MENU.**
The menu appears.
- 3 Select [MODE] (REC MODE) with ◀▶, [VOICE] with ▲/▼.**
- 4 Record the image.**
If you press and release the shutter button, sound is recorded for five seconds.
If you hold down the shutter button, sound is recorded until you release the shutter button for up to 40 seconds.

The number of images that you can record on a disc in VOICE mode*

MVC-CD200

Image size	Quality	
	STANDARD	FINE
1600×1200	Approx. 203	Approx. 121
1600 (3:2)	Approx. 203	Approx. 121

Image size	Quality	
	STANDARD	FINE
1024×768	Approx. 369	Approx. 262
640×480	Approx. 677	Approx. 451

MVC-CD300

Image size	Quality	
	STANDARD	FINE
2048×1536	Approx. 133	Approx. 77
2048 (3:2)	Approx. 133	Approx. 77
1600×1200	Approx. 203	Approx. 121
1280×960	Approx. 280	Approx. 172
640×480	Approx. 677	Approx. 451

* When recording 5-second audio.

To return to normal recording mode

Select [NORMAL] with ▲/▼ in step 3.

Recording text documents (TEXT)

Mode dial: 

The TEXT mode is suitable for recording a document to emphasize its character by the black and white colors. The LCD screen also turns to black and white, and the image is recorded in the GIF format.

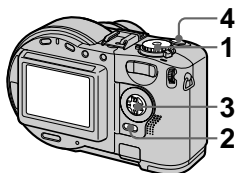

- 1 Set the mode dial to .
- 2 Press MENU.
The menu appears.
- 3 Select [MODE] (REC MODE) with ◀▶, [TEXT] with ▲/▼.
- 4 Record the image.

The number of images that you can record on a disc in TEXT mode*

MVC-CD200

Image size	
1600×1200	Minimum 330
1600 (3:2)	Minimum 361
1024×768	Minimum 618
640×480	Minimum 974

MVC-CD300

Image size	
2048×1536	Minimum 221
2048 (3:2)	Minimum 244
1600×1200	Minimum 330

Image size	
1280×960	Minimum 462
640×480	Minimum 974

* The maximum number of recordable images depends on the document condition, such as the amount of text portions.

To return to normal recording mode

Select [NORMAL] with ▲/▼ in step 3.

Notes

- If the subject is not evenly illuminated, you may be unable to record a clear image.
- Reading and writing data takes more time than normal image recording.
- When the mode dial is set to M or SCN, the image may be bleached out or may be turned black.
- The number of recordable images is the same regardless of whether [] (P. QUALITY) is set to [STANDARD] or [FINE].

Recording still images as uncompressed files (TIFF)

Mode dial: /S/A/M/SCN

Records the images without compression, so the image does not deteriorate. Images recorded in this mode are suitable for printing with a high-quality image. The JPEG (compressed) format image is also recorded with the TIFF format image.

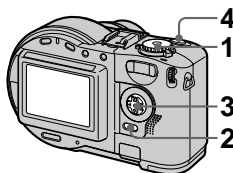

- 1 Set the mode dial to , S, A, M, or SCN.**
- 2 Press MENU.**
The menu appears.
- 3 Select [MODE] (REC MODE) with /▶, [TIFF] with ▲/▼.**
- 4 Record the image.**

The number of images that you can record on a disc in TIFF mode

MVC-CD200

Image size	Quality	
	STANDARD	FINE
1600×1200	Approx. 20	Approx. 19
1600 (3:2)	Approx. 22	Approx. 21

MVC-CD300

Image size	Quality	
	STANDARD	FINE
2048×1536	Approx. 12	Approx. 11
2048 (3:2)	Approx. 14	Approx. 13

To return to normal recording mode

Select [NORMAL] with ▲/▼ in step 3.

Notes

- JPEG images are recorded in the image size selected by the [] (IMAGE SIZE) menu (page 53). TIFF images are recorded in [1600×1200] (MVC-CD200) or [2048×1536] (MVC-CD300) size other than when [1600 (3:2)] (MVC-CD200) or [2048 (3:2)] (MVC-CD300) is selected.
- Writing data takes more time than in normal recording.

Recording three images with the exposure shifted (only for MVC-CD300) (EXP BRKTG)

Mode dial:  /S/A/M/SCN

The camera continuously records three images with each exposure value shifted. The exposure compensation value can be set between ± 1.0 EV from the correct exposure value by 1/3 EV.

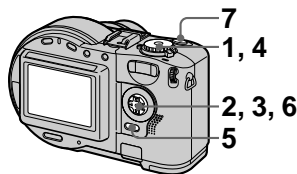

1 Set the mode dial to SET UP.

The setup screen appears.

2 Select [] (CAMERA) with ▲/▼, [BRACKET STEP] with ►/▲/▼, then press ►.

3 Select the desired bracket step value with ▲/▼, then press ●.

± 1.0 EV: Shifts the exposure value by plus or minus 1.0EV.

± 0.7 EV: Shifts the exposure value by plus or minus 0.7EV.

± 0.3 EV: Shifts the exposure value by plus or minus 0.3EV.

4 Set the mode dial to , S, A, M, or SCN.

5 Press MENU.

The menu appears.

6 Select [MODE] (REC MODE) with ◀/▶, [EXP BRKTG] with ▲/▼.

7 Record the image.

To return to normal recording mode
Select [NORMAL] with ▲/▼ in step 6.

Notes

- You cannot use the flash in this mode.
- During recording, the image is not displayed on the LCD screen. Make the composition before pressing the shutter button.
- Focus and white balance are adjusted against the first image and this setting is also used for the other images.
- When the exposure is manually adjusted, the adjusted value is used for the center value.
- The recording interval is approximate 0.6 second.

Creating Clip Motion Files

Mode dial: 

Clip Motion is an animation function that plays back still images in succession. The images are stored in GIF format, which is convenient for creating home pages or attaching images to an e-mail.

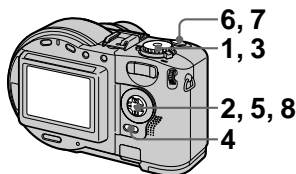

1 Set the mode dial to SET UP.
The setup screen appears.

2 Select [] (CAMERA) with ▲/▼, [MOVING IMAGE] with ►/▲/▼, [CLIP MOTION] with ▲/▼, then press ●.

3 Set the mode dial to .

4 Press MENU.
The menu appears.

5 Select [] (IMAGE SIZE) with ◀/▶, the desired mode with ▲/▼.

NORMAL (160×120)

Clip Motion of up to 10 frames can be recorded.

This is suitable for use on home pages, etc.

MOBILE (80×72)

Clip Motion of up to 2 frames can be recorded.

This is suitable for use with portable data terminals.

6 Record the image for the first frame.

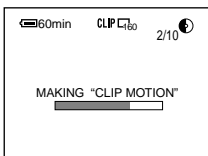

Before carrying out step 8, the images are temporarily stored in memory. These images are not recorded on the disc, yet.

7 Record the image for the next frame.

Image recording can be repeated up to the maximum number of recordable frames.

8 Press ●.

All the frame images are recorded on the disc.

To delete some of the frame images or all the frame images

① Press ◀ (Ⓢ) in step 6 or 7.

The recorded frame images are played back in turn.

② Press MENU, and select [DELETE LAST] or [DELETE ALL], then press ●.

③ Select [OK] with ▲/▼, then press ●.

When [DELETE LAST] is selected in step ②, each time you repeat steps ① – ③, the recorded frame is deleted from the newest one.

The number of Clip Motion frames that you can record on a disc

Image size	
NORMAL (160×120)	Approx. 560*
MOBILE (80×72)	Approx. 1430**

* When recording 10 frames per Clip Motion file

** When recording 2 frames per Clip Motion file

Notes

- You cannot change the image size partway through a Clip Motion recording.
- Reading and writing data takes more time than normal image recording.
- Due to the limitations of the GIF format, the number of colors for Clip Motion images is reduced to 256 colors or less. Therefore, the picture quality may deteriorate for some images.
- The file size is reduced in MOBILE mode, so the picture quality deteriorates.
- GIF files not created on this camera may not be displayed correctly.
- All the frame images are immediately recorded on the disc if the mode dial is switched or the power is turned off.

Setting the distance to the subject

Mode dial: / S / A / M / SCN /

Normally the focus is automatically adjusted. This function is useful when the auto focus does not work well such as in dark places.



- 1 Set the mode dial to , S, A, M, SCN, or .**
- 2 Press FOCUS.**
The focus is fixed and the (manual focus) indicator appears.
- 3 Turn the jog dial to select the desired focus setting.**
You can select from 15 focus settings (unit: m) including the position:
0.1, 0.2, 0.3, 0.5, 0.8, 1.0, 1.5, 2, 3, 5, 7, 10, 15, and ∞ (infinity)

To reactivate auto focusing

Press FOCUS again and the focal point information disappears.

Notes

- Focal point information may not completely show the correct distance. Use the information as a guide.
- The focus preset does not work properly when attaching a conversion lens.
- If you shoot a subject within 0.5 m (19 3/4 inches) with the zoom is set to the T side, you may not get a clear focus. In such cases, the focal point information flashes. Press the zoom W button until the indicator stops flashing.

Recording images in macro

Mode dial: / S / A / M / SCN /

The macro recording is used when zooming up a little subject, such as flowers, insects.



- 1 Set the mode dial to , S, A, M, SCN, or .**
- 2 Press the control button (↓) with the menu cleared.**
The (macro) indicator appears on the LCD screen.
With the zoom set to the W side, you can shoot a subject that is about 3 cm (1 3/16 inch) (MVC-CD200) or 4 cm (1 5/8 inch) (MVC-CD300) away from the lens surface in macro mode.

To return to normal recording mode

Press the control button (↓) again. The indicator disappears.

Note

You cannot record images in macro with the LANDSCAPE mode of the SCENE SELECTION function.

Adjusting the exposure (EXPOSURE)

Mode dial: /S/A/SCN/

Adjusts the exposure value which is set in the automatic adjustment.

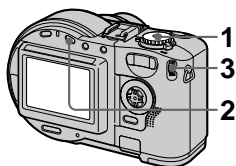

1 Set the mode dial to , S, A, SCN, or .

2 Press .

3 Select the desired exposure value with the jog dial.

Adjust the exposure value while checking the brightness of the background. You can select values ranging from +2.0 EV to -2.0 EV in steps of 1/3 EV.

Note

If a subject is under extremely bright or dark situations, or the flash is used, the exposure adjustment may not be effective.

Tip

Normally, the camera automatically adjusts the exposure. If the color of the image is too dark or bright as illustrated below, we recommend that you adjust the exposure manually. When recording a backlit subject or a subject in the snow, set it toward +, and when recording a dark subject with fully displayed on the LCD screen, set it toward -.

Set the exposure toward +



Set the exposure toward -

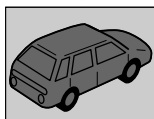
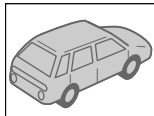

Adjusting the white balance (WHITE BALANCE)

Mode dial: / S / A / M / SCN /

Normally, the white balance is automatically adjusted (AUTO). When you record with the shooting condition fixed or under the specific lighting condition, you can manually adjust the white balance.

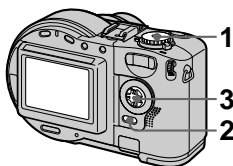

- 1 Set the mode dial to , S, A, M, SCN, or .**
- 2 Press MENU.**
The menu appears.
- 3 Select [WB] (WHITE BAL) with /, the desired setting with /.**

ONE PUSH ()

Adjusting the white balance depending on the light source

AUTO (No indicator)

Adjusts the white balance automatically

IN DOOR ()

- Places where the lighting condition changes quickly
- Under bright lighting such as photography studios
- Under sodium or mercury lamps

OUT DOOR ()

Recording a sunrise/sunset, night scene, neon signs, or fireworks

To shoot in one-push white balance mode

- ① Select [ONE PUSH].** The indicator appears.
- ② Shoot a white object** such as paper full under the same situation you will shoot.
- ③ Press .**
The indicator flashes quickly. When the white balance has been adjusted and stored in the memory, the indicator stops flashing.

To reactivate auto adjustment
Select [AUTO] with / in step 3.

Notes

- Select [AUTO] when shooting with fluorescent lighting.
- The indicator means:
Slow flashing: white balance is not set or was not able to be set.
Quick flashing: white balance is being adjusted (after you press).
Lit steady: white balance has been set.
- If the indicator keeps flashing even when you press record in automatic white balance mode.

Tip

The image is susceptible to lighting conditions. The image looks blue under sunlight in the summer, and looks red under mercury lamps. Human eyes can resolve these problems. However, the camera cannot resolve the problem by making adjustments. Normally, the camera adjusts it automatically, but, if the image appears in strange colors, we recommend that you change the white balance mode.

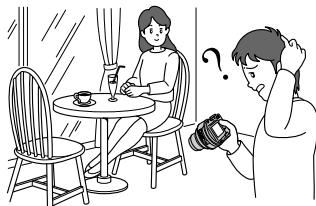

Enjoying picture effects (P. EFFECT)

Mode dial: /S/A/M/SCN/

You can digitally process images to obtain special effect.

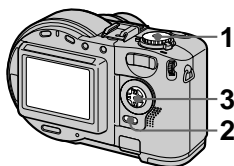

- 1** Set the mode dial to , S, A, M, SCN, or .
- 2** Press MENU.
The menu appears.
- 3** Select [PFX] (P. EFFECT) with , the desired mode with .

SOLARIZE

The light contrast is clearer and the picture looks like an illustration.

B&W

The picture is monochrome (black and white).

SEPIA

The picture is sepia-toned like an old photograph.

NEG.ART

The color and brightness of the picture are reversed as in a negative.

OFF

Does not use the picture effect function.

To cancel PICTURE EFFECT

Select [OFF] with /▼ in step 3.

Recording the date and time on the still image (DATE/TIME)

Mode dial:  / S / A / M / SCN

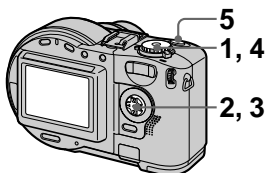

1 Set the mode dial to SET UP.

The setup screen appears.

2 Select [] (CAMERA) with ▲/▼, [DATE/TIME] with ►/▲/▼, then press ►.

3 Select the date and time setting with ▲/▼, then press ●.

DAY & TIME

Imposes the date, hour, and minute.

DATE

Imposes the year, month, and day.

OFF

Does not impose the date and time.

4 Set the mode dial to , S, A, M, or SCN.

5 Record the image.

The date and time do not appear on the LCD screen during shooting. These appear during playback only.



Notes

- If you select [DATE] in step 3, the date is imposed onto the image in the order selected with “Setting the date and time” (page 14).
- The date and time are not superimposed onto Clip Motion images.

Using the Spot light-metering function

Mode dial:  /S/A/M/SCN/

Use this function when there is backlight or when there is strong contrast between the subject and the background, etc.

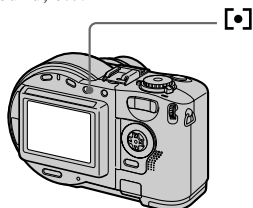

Press  to activate the spot light-metering function. Position the point you want to record at the spot light-metering cross hair.

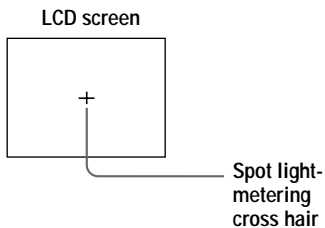

► Various playback

Playing back three or nine images at once

Mode dial: 

You can display multiple images on the LCD screen at one time using the zoom buttons.



- 1 Set the mode dial to .
- 2 Press the zoom W/T buttons repeatedly.

The LCD screen display changes as follows:

- Single (single-image) screen

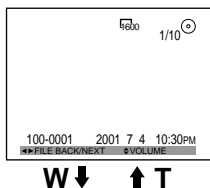

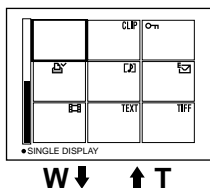

- Index (nine-image) screen



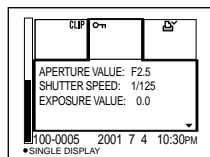



- Triple-image screen



The image indicated by the yellow frame in the index screen is displayed in the middle of the triple-image screen with the recording information. To display the other information, press / .

The following marks are displayed on each image according to the image type and settings.

-  : Moving image file
-  : VOICE mode file
-  : E-mail file
-  : Print mark
-  : Protect mark
- TEXT: TEXT file
- TIFF: TIFF file
- CLIP: Clip Motion file
- (No mark): Normal recording (no settings)

To display the next (previous) index screen

Press / / / .

To return to normal playback (single-image)

- Press the zoom T button repeatedly.
- Press .

Note

When viewing an image recorded in Clip Motion or TEXT mode on the index screen, the image may appear different from the actual image.





Tip

When the triple-image screen is displayed, pressing MENU opens the menu including [PRINT], [PROTECT], and [DELETE]. For details on items, see pages 77, 78, and 81. To close the menu, press MENU again. The menu disappears and the recording information is indicated.

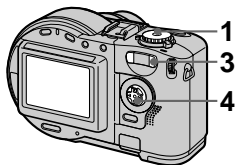
Enlarging a part of the still image (Zoom and trimming)





Mode dial: 



- 1 Set the mode dial to .
- 2 Display the image to be enlarged.
- 3 Zoom in the image with the zoom T button.
- 4 Press  repeatedly to select the desired portion of the image.
 - ▲: The image moves downward
 - ▼: The image moves upward
 - ◀: The image moves rightward
 - ▶: The image moves leftward

To return to the normal size
Press .

To record an enlarged image (trimming)

- ① Press MENU after zooming.
 - ② Select [TRIMMING] with , then press .
 - ③ Select the image size with , then press .
- The image is recorded and the image on the LCD screen returns to the normal size after recording.

Notes

- Zoom scaling is up to 5× regardless of the original image size.
- The quality of enlarged images may be deteriorated.
- The original data is left even if you enlarge the image.
- The enlarged image is recorded as the newest file.
- If you trim an image, the disc space will be decrease.
- If the disc space is not sufficient, you may be unable to trim an image.
- Moving images cannot be enlarged.
- The still images recorded in TEXT mode can be enlarged, but these images cannot be trimmed.
- You cannot trim to an image of 3:2.
- You cannot trim uncompressed (TIFF) images.

Playing back the still images in order (SLIDE)





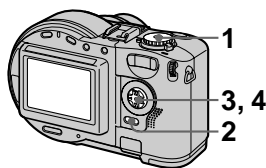

Mode dial: 

This function is useful for checking the recorded images or for presentations, etc.



1 Set the mode dial to .

2 Press **MENU**.
The menu appears.

3 Select **[SLIDE]** with , then press .
Set the following items with , , , and .

INTERVAL



You can select from 1 min (one minute), 30 sec (30 seconds), 10 sec (10 seconds), or 5 sec (5 seconds).

REPEAT

ON: Plays back images in a continuous loop (The slide show stops in approximately 20 minutes*).

OFF: After all images have been played back, the slide show ends.

* The slide show does not end until all the images are played back, even if it takes more than 20 minutes.

4 Select **[START]** with , then press .
The slide show begins.

To cancel the SLIDE SHOW setting

Select [CANCEL] with ▲▼/◀▶ in step 3, then press ●.

To stop the SLIDE SHOW playback

Press ●, select [EXIT] with ▶, then press ●.

To skip to the next/previous image during the SLIDE SHOW

Select ◀▶ at the lower-left on the LCD screen.

Note

The interval setting time may vary depending on the image size.

Rotating a still image (ROTATE)

Mode dial: ▶

You can rotate the image recorded in portrait orientation and display it in landscape orientation.

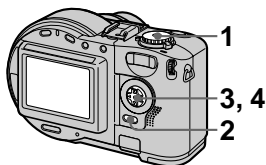

1 Set the mode dial to ▶, and display the image to rotate.

2 Press MENU.
The menu appears.

3 Select [ROTATE] with ◀▶, then press ●.

4 Select [↙, ↘] with ▲▼, then rotate the image with ◀▶. Select [OK] with ▲▼, then press ●.

To cancel rotation

Select [CANCEL] with ▲▼ in step 4, then press ●.

Notes

- You cannot rotate protected or uncompressed images, or images recorded in TEXT mode.
- You may not be able to rotate images recorded with other equipment.
- Also, when viewing images on a computer, the image rotation information may not be reflected depending on the application software.
- If you rotate an image, the disc space will decrease.
- If the disc space is not sufficient, you may not be able to rotate an image.

Viewing images on a TV screen

Mode dial: 

Before connecting your camera, be sure to turn off the TV.

Set the TV/VIDEO switch to "VIDEO".

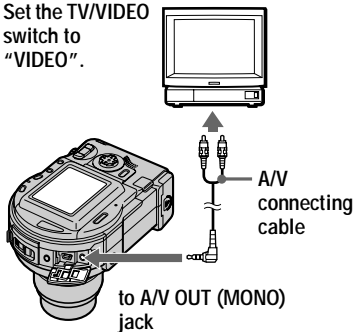

- 1 Set the mode dial to .
- 2 Connect the A/V connecting cable to the A/V OUT (MONO) jack of your camera and to the audio/video input jacks of the TV.

If your TV has stereo type input jacks, connect the audio plug (black) of the A/V connecting cable to the Lch jack.

- 3 Turn on the TV and start playback on your camera.
The playback image appears on the TV screen.

Notes

- You cannot use a TV that has an antenna (aerial) connector only.
- When viewing a still image on the TV, the black band may appear around the image.
- When images are not displayed on the TV screen, check that the VIDEO OUT item (page 85) is set to the appropriate position.









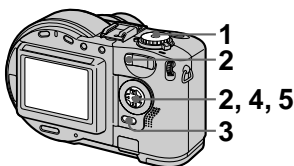



Deleting images (DELETE)

Mode dial: 

Protected images cannot be deleted.







In single-image or triple-image mode

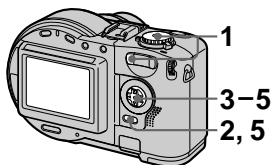

- 1 Set the mode dial to .
 - 2 In single-image mode:
Display the image you want to delete with  .
 - In triple-image mode:
Press the zoom W button twice to turn to the triple-image mode.
Display the image you want to delete with  .
- 3 Press MENU.
The menu appears.
 - 4 Select [DELETE] with   in single-image mode, or with   in triple-image mode, then press .
 - 5 Select [OK] with  , then press .
- The image (or the middle-positioned image in triple-image mode) is deleted.

In index mode



- 1 Set the mode dial to , then display the index screen with the zoom W button.
- 2 Press MENU.
The menu appears.
- 3 Select [DELETE] with  , then press .
- 4 Select [ALL] or [SELECT] with  , then press .

5 When you select [ALL]

Select [ENTER] with ◀▶, then press ●.

All the unprotected images are deleted.

When you select [SELECT]

The frame of the selected image turns green.

- 1 Select the image to be deleted with ▲▼/◀▶, then press ●. To cancel, press ● again. Repeat this step to select other images. The  (delete) indicator appears on the selected images.

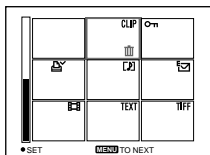



- 2 Press MENU.
- 3 Select [OK] with ◀▶, then press ●.

To cancel deleting

Select [CANCEL] with ◀▶ in step 4 or [EXIT] with ◀▶ in step 5, then press ●.

Notes

- When using a CD-R, even if you delete images, the disc remaining space does not increase.
- Only when using a CD-RW, the disc remaining space increases after deleting the last-recorded image if the  is indicated on the LCD screen before deleting. If you modify an image, or open and close the disc cover,  will disappear.
- If the disc space is not sufficient, you may not be able to delete an image.
- If the lower four-digit file number of an image is the same as the number of the selected image, that image also will be deleted.



Preventing accidental erasure (PROTECT)

Mode dial: 

Protects images against accidental erasure. Once you format a CD-RW (page 82), images recorded on the CD-RW are all deleted even if they are protected images.

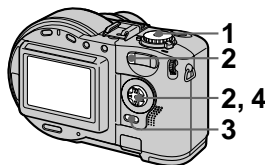
In single-image or triple-image mode







- 1 Set the mode dial to .
- 2 **In single-image mode**
Display the image you want to protect with ◀▶.
In triple-image mode
Press the zoom W button twice to turn to the triple-image mode. Display the image you want to protect with ◀▶.
- 3 Press MENU.
The menu appears.
- 4 **Select [PROTECT] with ◀▶ in single-image mode, or with ▲▼ in triple-image mode, then press ●.**
The displayed image (or the middle-positioned image in triple-image mode) is protected. The  (protect) indicator appears on the image.

To release protection

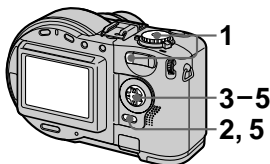
Press ● again in step 4. The  indicator disappears.

In index mode



- 1 Set the mode dial to , then display the index screen with the zoom W button.
- 2 Press MENU.
The menu appears.
- 3 Select [PROTECT] with , then press ●.
- 4 Select [ALL] or [SELECT] with , then press ●.





5 When you select [ALL]

Select [ON] with , then press ●.

All the images in the disc are protected.

When you select [SELECT]



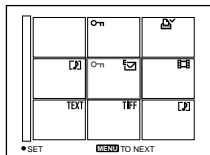

The frame of the selected image turns green.

- ① Select the image to be protected with , , , then press ●. To cancel, press ● again. Repeat this step to select other images. The  indicator appears on the selected images.





- ② Press MENU.
- ③ Select [OK] with , then press ●.

To release protection

If you selected [ALL] in step 4, select [OFF] with , then press ●. If you selected [SELECT] in step 4, select the image to be unprotected with , , , then press ●. Repeat this step to select other images. Press MENU and select [OK] with , then press ●.

To cancel protection

Select [CANCEL] with  in step 4 or [EXIT] with  in step 5, then press ●.

Notes

- If you protect an image, the disc space will decrease. Also, if you release protection, the disc space will decrease.
- If the disc space is not sufficient, you may not be able to protect an image.

Changing the recorded still image size (RESIZE)

Mode dial: 

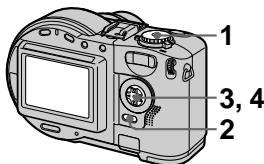

You can change the image size of the recorded image.





1 Set the mode dial to , then display the image of which you want to change the size.

2 Press MENU.
The menu appears.

3 Select [RESIZE] with , then press .

4 Select the desired size with , then press .
MVC-CD200: 1600×1200,
1024×768, 640×480
MVC-CD300: 2048×1536,
1600×1200, 1280×960, 640×480
The resized image is recorded.

To cancel changing the size
Select [CANCEL] with , then press .

Notes

- When you change from a small size to a large size, the picture quality deteriorates.
- The original image is retained even after resizing.
- You cannot change the size of images recorded in TEXT mode, moving images, uncompressed images, or Clip Motion images.
- The resized image is recorded as the newest file.
- If you resize an image, the disc space will decrease.
- If the disc space is not sufficient, you may not be able to resize an image.
- You cannot resize to an image of 3:2.
- When you resize a 3:2 image, the upper and lower black portions are displayed on the LCD screen.

Selecting still images to print (PRINT)

Mode dial:

You can mark a print mark on still images recorded with your camera. This mark is convenient when you have images printed at a shop that conforms with the DPOF (Digital Print Order Format) standard.

In single-image or triple-image mode

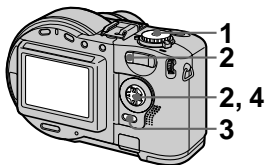

- 1 Set the mode dial to .
- 2 **In single-image mode**
Display the image you want to print with .
In triple-image mode
Press the zoom W button twice to turn to the triple-image mode. Display the image you want to print with .
- 3 **Press MENU.**
The menu appears.
- 4 **Select [PRINT] with in single-image mode, or with in triple-image mode, then press .**
The (print) mark is marked on the displayed image (or the middle-positioned image in triple-image mode).

To unmark the print mark
Press again in step 4. mark disappear.

In index mode

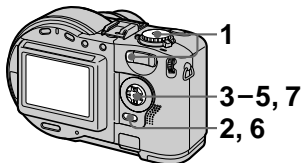

- 1 Set the mode dial to , then display the index screen with the zoom W button.
- 2 **Press MENU.**
The menu appears.
- 3 **Select [PRINT] with , then press .**
- 4 **Select [SELECT] with , then press .**
When marking the mark, you cannot select [ALL].
The frame of the selected image turns green.
- 5 **Select the image to be marked with , then press .**
To cancel, press again.
Repeat this step to select other images. The mark appears on the selected image.

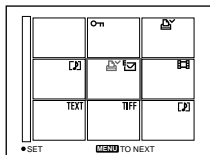

6 Press MENU.

The menu appears.

7 Select [OK] with ◀▶, then press ●.

To unmark selected print marks

Select the image to be unmarked in step 5 with ▲▼/◀▶, then press ●.

To unmark all the print marks

Select [ALL] with ◀▶ in step 4, then press ●. Select [OFF] with ◀▶, then press ●.

The 🖨️ marks on all images are unmarked.

To cancel marking the print mark

Select [CANCEL] with ◀▶ in step 4, then press ●, or select [EXIT] with ◀▶ in step 7, then press ●.

Notes

- You cannot mark moving images, Clip Motion images or images recorded in TEXT mode.
- If you mark an image recorded in TIFF mode with a print mark, only the uncompressed image is printed, and the JPEG image recorded at the same time is not printed.
- If you mark an image with a print mark, the disc space will decrease. Also, if you unmark the print mark, the disc space will decrease.
- If the disc space is not sufficient, you may not be able to mark an image with a print mark.

Formatting a CD-RW

When deleting all the images in the CD-RW or using the CD-RW formatted with other equipment than this camera, format the CD-RW. When you format a CD-RW, all data stored on the disc will be deleted. Check the contents of the disc before formatting. The initialization is also executed after the format.



- 1 Insert only the CD-RW you want to format.**
- 2 Set the mode dial to SET UP.**
The setup screen appears.
- 3 Select [DISC TOOL] with ▲▼, [FORMAT] with ▶/▲▼, then press ▶.**
- 4 Select [OK] with ▲▼, then press ●.**
“FORMAT PLACE ON LEVEL SURFACE” appears on the LCD screen.
- 5 Select [OK] with ▲▼, then press ●.**

To cancel formatting

Select [CANCEL] with ▲▼ in step 3, then press ●.

Notes

- When you format, be sure to use a fully charged battery pack or the AC power adaptor as the power source.
- CD-Rs cannot be formatted.
- The disc which is formatted using other equipment than this camera cannot be used with this camera. Format the disc again with this camera.
- It takes about seven minutes to execute the format.
- About 300 times formatting can be available on a CD-RW.
- Once you format the CD-RW, protected images are also deleted.

Changing the setup settings (SET UP)

Set the mode dial to SET UP. The setup screen appears. You can set up the following items with the control button.

DISC TOOL

Item	Setting	Description
FINALIZE	OK	Finalizes a disc (page 32).
	CANCEL	Cancels the finalization.
FORMAT	OK	Formats a CD-RW (page 82).
	CANCEL	Cancels formatting of the CD-RW.
INITIALIZE	OK	Initializes a disc (page 18).
	CANCEL	Cancels the initialization.
UNFINALIZE	OK	Unfinalizes a CD-RW (page 34).
	CANCEL	Cancels the unfinalization.

CAMERA

Item	Setting	Description
SCENE SELECTION	■ TWILIGHT LANDSCAPE PORTRAIT	Selects the SCENE SELECTION mode that is assigned to the SCN position (page 58).
MOVING IMAGE	■ MPEG MOVIE CLIP MOTION	Records the MPEG movie (page 26). Records the Clip Motion.
DATE/TIME	DAY & TIME DATE ■ OFF	Sets whether to insert the date and time into the still image (page 70).
DIGITAL ZOOM	■ ON OFF	Uses digital zoom (page 23). Does not use digital zoom.
BRACKET STEP (MVC-CD300 only)	±1.0EV ■ ±0.7EV ±0.3EV	Sets the exposure plus minus value when recording three images with each exposure value shifted (page 63).
RED EYE REDUCTION	ON ■ OFF	Reduces the red-eye phenomenon (page 24).
AF ILLUMINATOR	■ ON OFF	Uses when it is hard to focus on the subject under dark situations (page 25).

SETUP 1

Item	Setting	Description
FILE NUMBER	SERIES	Assigns numbers to files in sequence even if the disc is changed.
	■RESET	Resets the file number that starts from 0001 each time the disc is changed.
CONVERSION LENS (MVC-CD300 only)	ON	Set to [ON] when using the VCL-MHG07 conversion lens (not supplied). At this time, the zoom function does not work. Also, note that the VAD-S70 adaptor ring needed to mount the conversion lens to your camera is not sold in some countries and regions.
	■OFF	
言語 / LANGUAGE	■ENGLISH	Displays the menu items in English.
	日本語 / JPN	Displays the menu items in Japanese.
CLOCK SET	OK	Sets the date and time (page 14).
	CANCEL	

When [CONVERSION LENS] is set to [ON]:

- The SCENE SELECTION and zoom functions are not activated.
- When the mode dial is set to S or M, the iris value can be selected only from F4 or more.
- The focus preset is not activated.
- The macro recording is not activated.

SETUP 2

Item	Setting	Description
LCD BRIGHTNESS	BRIGHT	Selects the LCD brightness (page 22).
	■NORMAL DARK	
LCD BACKLIGHT	BRIGHT	Selects the brightness of the LCD backlight.
	■NORMAL	
BEEP	SHUTTER	Turns on the shutter sound only. (The shutter sound is heard when you press the shutter button.)
	■ON	Turns on the beep/shutter sound (when you press the control button/shutter button).
	OFF	Turns off the beep/shutter sound.
VIDEO OUT	NTSC	Sets the video output signal to NTSC mode (e.g., Japan, the USA).
	PAL	Sets the video output signal to PAL mode (e.g., Europe).

Item	Setting	Description
USB CONNECT	PTP <input checked="" type="checkbox"/> NORMAL	Switches the USB mode (page 35).
DEMO	<input checked="" type="checkbox"/> ON OFF	This is activated only when using the AC power adaptor. [DEMO] is set to [STBY] at the factory and the demonstration starts about 10 minutes after you have set the mode dial to  , S, A, M, or SCN. To cancel the demonstration, turn off the power.

Additional information

Precautions

The set is not disconnected from the AC power source (mains) as long as it is connected to the wall outlet, even if the set itself has been turned off.

On handling the camera

Do not carry the camera by holding the disc cover

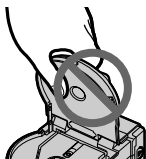

Do not touch the rotating disc

This may cause serious injuries.

On pickup lens cleaning

When the pickup lens is dirty and the camera cannot read any image, clean the pickup lens using a commercially available blower.

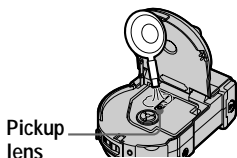

On cleaning

Cleaning the LCD screen

Wipe the screen surface with a cleaning cloth (not supplied) or an LCD cleaning kit (not supplied) to remove fingerprints, dust, etc.

Cleaning the camera surface

Clean the camera surface with a soft cloth slightly moistened with water, then wipe the surface dry. Do not use any type of solvent such as thinner, alcohol or benzene as this may damage the finish or the casing.

After using your camera at the seashore or other dusty locations

Clean your camera carefully. Otherwise, the salty air may corrode the metal fittings or dust may enter the inside of your camera, causing a malfunction.

On operating temperature

Your camera is designed for use between the temperatures of 0°C to 40°C (32°F to 104°F). Recording in extremely cold or hot places that exceed this range is not recommended.

On moisture condensation

If the camera is brought directly from a cold to a warm location, or is placed in a very damp room, moisture may condense inside or outside the camera. Should this occur, the camera will not operate properly.

Moisture condensation occurs easily when:

- The camera is brought from a cold location such as a ski slope into a warmly heated room.
- The camera is taken from an air-conditioned room or car interior to the hot outdoors, etc.

How to prevent moisture condensation

When bringing the camera from a cold place to a warm place, seal the camera in a plastic bag and allow it to adapt to conditions at the new location over a period of time (about an hour).

If moisture condensation occurs

Turn off the camera and wait about an hour for the moisture to evaporate. Note that if you attempt to record with moisture remaining inside the lens, you will be unable to record clear images.

On pickup lens

Do not touch the pickup lens inside the disc cover. And do not open the disc cover except when inserting or removing a disc to keep dust out.

On AC power adaptor

- Unplug the unit from the wall outlet (mains) when you are not using the unit for a long time. To disconnect the power cord (mains lead), pull it out by the plug. Never pull the power cord (mains lead) itself.
- Do not operate the unit with a damaged cord (mains lead) or if the unit has been dropped or damaged.
- Do not bend the power cord (mains lead) forcibly, or place a heavy object on it. This will damage the cord (mains lead) and may cause fire or electrical shock.
- Prevent metallic objects from coming into contact with the metal parts of the connecting section. If this happens, a short may occur and the unit may be damaged.
- Always keep metal contacts clean.
- Do not disassemble the unit.
- Do not apply mechanical shock or drop the unit.
- While the unit is in use, particularly during charging, keep it away from AM receivers and video equipment. AM receivers and video equipment disturb AM reception and video operation.
- The unit becomes warm during use. This is not a malfunction.

- Do not place the unit in locations that are:
 - Extremely hot or cold
 - Dusty or dirty
 - Very humid
 - Vibrating

On battery pack

- Use only the specified charger with the charging function.
- To prevent accident from a short circuit, do not allow metal objects to come into contact with the battery terminals.
- Keep the battery pack away from fire.
- Never expose the battery pack to temperatures above 60°C (140°F), such as in a car parked in the sun or under direct sunlight.
- Keep the battery pack dry.
- Do not expose the battery pack to any mechanical shock.
- Do not disassemble nor modify the battery pack.
- Attach the battery pack to the camera securely.
- Charging while some capacity remains does not affect the original battery capacity.

On the built-in rechargeable lithium battery

Your camera is supplied with a built-in rechargeable lithium battery installed so as to retain the date and time, etc., regardless of the setting of the POWER switch. The built-in rechargeable lithium battery is always charged as long as you are using your camera. The battery, however, will get discharged gradually if you do not use your camera. It will be completely discharged in about one month if you do not use your camera at all. Even if the built-in rechargeable lithium battery is not charged, it will not affect the camera operation. To retain the date and time, etc., charge the battery if the battery is discharged.

Charging the built-in rechargeable lithium battery:

- Connect your camera to house current (mains) using the AC power adaptor supplied with your camera, and leave your camera with the power turned off for more than 24 hours.
- Or install the fully charged battery pack in your camera, and leave your camera with the power turned off for more than 24 hours.

If any problem occurs, unplug your camera and contact your nearest Sony dealer.

On discs

Be sure to use only 8 cm CD-Rs/CD-RWs. You cannot read or write data on other type discs that do not correspond to this camera.

On cleaning

- Do not clean a disc using a cleaner before recording. Use a commercially available blower to remove dust.
- If fingerprints, dust, drop of water, or oil makes the recordable side (the other side of the printed side) of a disc dirty, the camera may not properly record an image on the disc. You should handle a disc with a lot of care.
- If a disc does become dirty, wipe it in a straight line from center to edge with a soft dry cloth or a soft cloth lightly moistened with a mild detergent solution. You can use a commercially available CD cleaner.

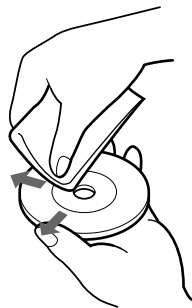

- Do not use any solvent (benzine, thinner, static protection product, record cleaner, etc.) to clean a disc.

Notes

- Do not remove the disc while reading or writing data.

- Data may be damaged if:
 - You remove the disc or turn off the power while reading or writing data.
 - You use the camera in a location subject to the effects of static electricity or noise.
- Do not attach any material on the surface of a disc. This causes a nonuniform rotating speed and this may cause a malfunction of the camera.
- You can write only on the label surface of a disc. When you write, use only a felt-tip marker and do not touch it until it is in dry state, and do not heat it. Do not use a sharp-pointed tool, such as a ballpoint pen.
- Hold a disc at the edges while pressing the center hole lightly. Do not touch the recordable side (the other side of the printed side) of a disc.

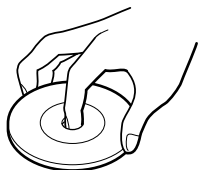

- When you carry or store a disc, put it in its case.
- Do not strike, bend or drop a disc, or rub the edge of a disc.
- Do not store a disc in the following locations:
 - In dusty or dirty places
 - Under direct sunlight
 - Near heaters
 - In dump places
- If you play back the disc on which any image has not been recorded using a CD-ROM drive, the CD-ROM drive may malfunction or the disc may be scratched.

Using your camera abroad

Power sources

You can use your camera in any country or area with the supplied battery charger within 100 V to

240 V AC, 50/60 Hz. Use a commercially available AC plug adaptor [a], if necessary, depending on the design of the wall outlet (mains) [b].

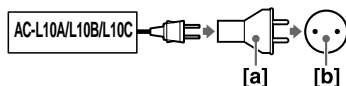

Watching the playback picture on TV

If you want to view the playback picture on a TV, you need a TV having a video input jack and a video connecting cable.

The color system of the TV must be the same as that of your digital still camera. Check the following list:

NTSC system

Bahama Islands, Bolivia, Canada, Central America, Chile, Columbia, Ecuador, Jamaica, Japan, Korea, Mexico, Peru, Surinam, Taiwan, the Philippines, the U.S.A., Venezuela, etc.

PAL system

Australia, Austria, Belgium, China, Denmark, Finland, Germany, Great Britain, Holland, Italy, Kuwait, Malaysia, New Zealand, Norway, Portugal, Singapore, Spain, Sweden, Switzerland, Thailand, etc.

PAL-M system

Brazil

PAL-N system

Argentina, Paraguay, Uruguay

SECAM system

Bulgaria, Czech Republic, France, Guiana, Hungary, Iran, Iraq, Monaco, Poland, Russia, Slovak Republic, Ukraine, etc.

About “InfoLITHIUM” battery pack

What is the “InfoLITHIUM” battery pack?

The “InfoLITHIUM” battery pack is a lithium-ion battery pack that has functions for communicating information related to operating conditions between your camera and the AC power adaptor.

The “InfoLITHIUM” battery pack calculates the power consumption according to the operating conditions of your camera, and displays the remaining battery time in minutes.

Charging the battery pack

- Be sure to charge the battery pack before you start using your camera.
- We recommend charging the battery pack in an ambient temperature of between 10°C to 30°C (50°F to 86°F) until the /CHG lamp goes out, indicating that the battery pack is fully charged. If you charge the battery pack outside of this temperature range, you may not be able to efficiently charge the battery pack.
- After charging is completed, either disconnect the AC power adaptor from the DC IN jack on your camera or remove the battery pack.

Effective use of the battery pack

- Battery performance decreases in low-temperature surroundings. So, the time that the battery pack can be used is shorter in cold places. We recommend the following to use the battery pack longer:
 - Put the battery pack in a pocket close to your body to warm it up, and insert it in your camera immediately before you start taking shots.
- Frequently operating the zoom wears out the battery pack faster.
- Be certain to turn the POWER switch to off when not taking shots or playing back on your camera.
- We recommend having spare batteries handy for two or three times the expected shooting time, and make a trial shots before taking the actual shots.
- Do not expose the battery pack to water. The battery pack is not water-resistant.

Remaining battery time indicator

- If the power goes off although the battery remaining indicator indicates that the battery pack has enough power to operate, charge the battery pack fully again so that the indication on the battery remaining indicator is correct. Note, however, that the correct battery indication sometimes will not be restored if it is used in high temperatures for a long time or left in a fully charged state, or the battery pack is frequently used. Regard the remaining battery time indication as the approximate shooting time.

- The  mark indicating there is little remaining battery time sometimes flashes depending on the operating conditions or ambient temperature and environment even if the remaining battery time is 5 to 10 minutes.

How to store the battery pack





- Even if the battery pack is not used for a long time, store it in a dry, cool place after fully charging it once per year and then using the battery pack up on your camera. This is to maintain the battery pack's functions.
- To use the battery pack up on your camera, leave the POWER switch to on in  mode until the power goes off without a disc inserted.

Battery life







- The battery life is limited. Battery capacity decreases little by little as you use it more and more, and as time passes. When the battery operating time is shortened considerably, a probable cause is that the battery pack has reached the end of its life. Please buy a new battery pack.
- The battery life varies according to how it is stored and operating conditions and environment for each battery pack.

Troubleshooting

If you experience trouble with your camera, first check the following items. Should your camera still not operate properly after you have made these checks, press the reset button located on the bottom. (If you press the reset button, the date and time setting is cleared.) Should your camera still not operate properly, consult your Sony dealer or local authorized Sony service facility. **If code displays (C:□□:□□) appear on the LCD screen, the self-diagnosis display function is working (page 102).**

Symptom	Cause and/or Solution
Your camera does not work.	<ul style="list-style-type: none">• You are not using an “InfoLITHIUM” battery pack. →Use an “InfoLITHIUM” battery pack (page 9).• The disc is not inserted properly. →Eject the disc, and insert it again (page 16).• The battery level is too low. (The  indicator appears.) →Charge the battery pack fully (page 10).• The AC power adaptor is not connected securely. →Connect it securely to the DC IN jack and a wall outlet (mains) (page 10, 13).• The malfunction occurs inside the camera. →Turn off the power, and turn on after one minute, then check that the camera works properly.
Your camera cannot record images.	<ul style="list-style-type: none">• The mode dial is set to  or SET UP. →Set it to , S, A, M, SCN, or  (pages 20, 26).• No disc is inserted into your camera. →Insert a disc (page 16).• The disc has not been initialized. →Initialize the disc (page 18).

Symptom	Cause and/or Solution
The picture is out of focus.	<ul style="list-style-type: none"> • Your camera is not in macro recording mode when you shoot a subject that is about 3 to 50 cm (1 3/16 to 19 3/4 inches) (MVC-CD200) or about 4 to 50 cm (1 5/8 to 19 3/4 inches) (MVC-CD300) away from the lens. <ul style="list-style-type: none"> →Set the macro recording mode (page 66). →Press the zoom W button repeatedly. • The LANDSCAPE mode of the SCENE SELECTION function is selected. <ul style="list-style-type: none"> →Cancel the function. • The focus preset is selected. <ul style="list-style-type: none"> →Cancel the function. • [CONVERSION LENS] is set to [ON] in the setup settings (MVC-CD300 only). <ul style="list-style-type: none"> →Set it to [OFF] (page 85).
The resizing function does not work.	<ul style="list-style-type: none"> • You cannot resize moving images, text images, Clip Motion images, and uncompressed images.
You cannot display a print mark.	<ul style="list-style-type: none"> • You cannot display print marks on moving images, text images and Clip Motion images.
The picture is noisy.	<ul style="list-style-type: none"> • Your camera is placed near a TV or other equipment that uses strong magnets. <ul style="list-style-type: none"> →Move your camera away from the TV, etc.
The picture is too dark.	<ul style="list-style-type: none"> • You are shooting a subject with a light source behind the subject. <ul style="list-style-type: none"> →Adjust the exposure (page 67). • The brightness of the LCD screen is too low. <ul style="list-style-type: none"> →Adjust the brightness of the LCD screen (page 22).

Symptom	Cause and/or Solution
The flash does not work.	<ul style="list-style-type: none"> • The flash is set to  . →Set the flash to (no indication) or  (page 24). • The mode dial is set to , SET UP, or  (MPEG MOVIE). →Set it to , S, A, M, SCN, or  (CLIP MOTION). • The camera is in one of the following SCENE SELECTION modes: TWILIGHT or LANDSCAPE. →Cancel the SCENE SELECTION function or set the flash to  (page 24, 58). • [MODE] (REC MODE) is set to [EXP BRKTG] or [BURST] (MVC-CD300 only) in the menu settings. →Set it to the other modes.
The date and time are recorded incorrectly.	<ul style="list-style-type: none"> • The date and time are not set correctly. →Set the correct date and time (page 14).
Vertical streaks appear when you are shooting a very bright subject.	<ul style="list-style-type: none"> • This is called the smear phenomenon. This is not a malfunction. →Set the exposure toward – (page 67).
The zoom does not work. (MVC-CD300 only)	<ul style="list-style-type: none"> • [CONVERSION LENS] is set to [ON] in the setup settings. →Set it to [OFF] (page 85). • The zoom cannot be used when recording a moving image with [MOVING IMAGE] set to [MPEG MOVIE].
Digital zoom does not function.	<ul style="list-style-type: none"> • The digital zoom cannot be used when recording a moving image with [MOVING IMAGE] set to [MPEG MOVIE]. • [DIGITAL ZOOM] is set to [OFF]. →Set [DIGITAL ZOOM] to [ON] in the menu settings (page 23).
The image is in monochrome.	<ul style="list-style-type: none"> • You shot the image in TEXT mode. →Cancel the TEXT mode (page 61). • [PFX] (P. EFFECT) is set to [B&W] in the menu settings. →Cancel the B&W mode (page 69).

Symptom	Cause and/or Solution
<p>The image cannot be played back on the CD-ROM drive of your computer.</p>	<ul style="list-style-type: none"> • The disc has not been finalized. →Finalize the disc (page 32). • An error occurs during recording by vibration. →Possibly, you may be able to play back images if you connect the camera to your computer with the USB cable. • The CD-ROM drive does not correspond to the packet-write system or does not conform to the MultiRead type. →Consult the computer or the CD-ROM drive manufacturer. • Causes not described above are occurred. →Consult the computer or software manufacturer.
<p>Your camera cannot delete an image.</p>	<ul style="list-style-type: none"> • The disc is not initialized. →Initialize the disc (page 18). • The disc space is not sufficient. →This is not a malfunction. • The image is protected. →Cancel the protection (page 78).
<p>The power turns off suddenly.</p>	<ul style="list-style-type: none"> • If you do not operate the camera for about three minutes while the power is on, the camera turns off automatically to prevent wearing down the battery pack. →Turn on the camera. • The battery pack is discharged. →Replace it with a fully charged battery pack.
<p>The image does not appear on the TV screen.</p>	<ul style="list-style-type: none"> • The [VIDEO OUT] setting of your camera is incorrect. →Change the setting (page 85).
<p>The SLIDE SHOW function stops automatically.</p>	<ul style="list-style-type: none"> • The SLIDE SHOW function stops after about 20 minutes. →To continue the slide show, select [START] again (page 74).
<p>The macro function does not work.</p>	<ul style="list-style-type: none"> • [SCENE SELECTION] is set to [LANDSCAPE] in the setup settings. →Cancel the SCENE SELECTION function (page 58). • [CONVERSION LENS] is set to [ON] in the setup settings (MVC-CD300 only). →Set it to [OFF] (page 85).

Symptom	Cause and/or Solution
The TEXT mode recording cannot be properly done.	<ul style="list-style-type: none"> • The subject is not under even lighting situations. →Change lighting. • The mode dial is set to S, A, M, or SCN. →Set it to .
Your computer does not recognize your camera.	<ul style="list-style-type: none"> • The battery level is low. →Use the AC power adaptor (page 13). • The camera is turned off. →Turn on the camera. • The USB cable is not connected firmly. →Disconnect the USB cable, and connect it again firmly. Make sure that “USB MODE” is displayed on the LCD screen (page 38). • The USB connectors on your computer are connected to other equipment besides the keyboard, the mouse, and your camera. →Disconnect the USB cables except for the ones connected to the keyboard, the mouse, and your camera. • The USB driver is not installed. →Install the USB driver (page 38). • [USB CONNECT] is set to [PTP] in the setup settings. →Set it to [NORMAL] (page 86). • Since the camera is connected to a computer with the USB cable before installing the USB driver, the drive is not recognized by the computer. →Delete the drive which is not recognized, then install the USB driver. For details, see the procedure below.

Reinstall the USB driver when using Windows 98, Windows 98SE, Windows Me and Windows 2000 Professional

Perform all steps without skipping.

- 1 Turn on your computer and allow Windows to load.**
- 2 Connect the USB jack on the camera and the computer with the supplied USB cable.**
- 3 Insert a disc.**
- 4 Connect the AC power adaptor to your camera and then to a wall outlet (mains), and turn on the power of your camera.**

5 Open “Device Manager” on Windows.

For Windows 98, Windows 98SE and Windows Me users:

- ① Open [Control Panel] from [My Computer], then double-click [System].
- ② “System properties” is displayed. Click the [Device Manager] tab located at the top.
- ③ Click [CD Mavica] in [Other devices], then click the [Remove] button located at the lower-right corner.

For Windows 2000 Professional users:

* Log in with the permission of administrator.

- ① Open [Control Panel] from [My Computer], then double-click [System].
- ② “System properties” is displayed. Click the [Hardware] tab located at the top, then click the [Device Manager (D)] button.
- ③ Click [View] in [Device Manager], then click [Devices by type (E)].
- ④ Right-click [CD Mavica] in [Other devices], then click [Uninstall...].



6 After the message appears to verify that you delete the device manager, click “OK.”

7 Turn off the camera, disconnect the USB cable, and restart the computer.

8 Install the USB driver in the supplied CD-ROM to the computer following the procedure on page 38.

Battery packs



Symptom	Cause and/or Solution
The battery pack cannot be charged.	<ul style="list-style-type: none">• The power of the camera is turned on. → Turn off the power of the camera (page 10).
The battery life is short.	<ul style="list-style-type: none">• You are recording/playing back images under extremely cold temperatures.• The battery pack is not charged enough. → Charge the battery pack fully.• The battery pack is dead. → Replace the battery pack with a new one.

Symptom	Cause and/or Solution
The indication of the battery remaining time is not proper, or the power is immediately turned off even if the battery remaining indicator indicates that the battery level is sufficient.	<ul style="list-style-type: none"> • You are using the camera for many hours under extremely hot or cold temperatures. • The battery pack is dead. → Replace the battery pack with a new one (page 9). • The battery level is too low. → Install the fully charged battery pack (page 9, 10). • A deviation has occurred in the remaining battery time. → Charge the battery pack fully (page 10).
The  /CHG lamp flashes when charging a battery pack.	<ul style="list-style-type: none"> • A malfunction has occurred in the battery pack. → Contact your Sony dealer or local authorized Sony service facility.
The  /CHG lamp does not light up when charging a battery pack.	<ul style="list-style-type: none"> • The AC power adaptor is not connected. → Connect the power cord firmly to a wall outlet (mains) (page 10). • The battery pack is not installed properly. → Install it properly (page 9). • Charging of the battery pack is complete.
No function works though the power is on.	<ul style="list-style-type: none"> • — → Remove the battery pack, then install it again after about one minute. If the function still do not work, press the reset button located on the bottom using a sharp-pointed object. (If you press the reset button, the date and time setting is cleared.)

Warning and notice messages

Various messages appear on the LCD screen. Check the corresponding descriptions in the following list.

Message	Meaning
LENS CAP ATTACHED	The lens cap is attached.
COVER OPEN	The disc cover is opened.
NO DISC	No disc is inserted.
DRIVE ERROR	There is trouble with the disc drive or the camera.
DISC ERROR	An unusable disc is inserted or there is trouble with the disc.
DEW ERROR	A moisture condensation has occurred inside the camera.
DISC PROTECT	The disc was protected with a computer.
DIRECTORY ERROR	The same directory exists.
NOT ENOUGH DISC SPACE	The remaining capacity of the disc is not enough to operate other than executing the finalization.
NOT INITIALIZED	Since the disc has not been initialized, the camera cannot record any image on the disc.
ALREADY INITIALIZED	It is not necessary to execute the initialization, the disc was initialized.
ALREADY FINALIZED	It is not necessary to execute the finalization, the disc was finalized.
NO FILE	No image is recorded on the disc.
FILE ERROR	Trouble has occurred during playback.
IMAGE SIZE OVER	You tried to play back images with an image size larger than the maximum playback size of this camera.
INVALID OPERATION	You try to play back the image recorded with other equipment.
FILE PROTECT	The image is protected.
For "InfoLITHIUM" BATTERY ONLY	The battery is not the "InfoLITHIUM" type.
NOT ENOUGH BATTERY	The battery level is too low to execute the initialization or finalization.

Message	Meaning
	The battery level is too low.
CAN NOT UNFINALIZE	A CD-R or the disc that is not finalized is inserted.
CAN NOT FORMAT	A CD-R is inserted.
FORMAT ERROR	The disc that is formatted using other equipment than this camera is inserted.
TURN THE POWER OFF AND ON AGAIN	A malfunction occurs on the lens (MVC-CD300 only).
	The amount of light is not sufficient or the shutter speed is too slow.

Self-diagnosis display

Your camera has a self-diagnosis display. This function displays the camera condition on the LCD screen with a combination of a letter and four digits of numbers. If this appears, check the following code chart. The code informs you of the camera's current condition. The last two digits (indicated by □□) will differ depending on the state of the camera.

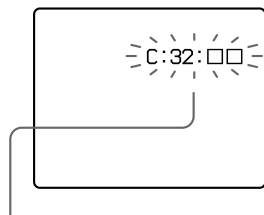

Self-diagnosis display

- C: □□: □□

You can repair the camera yourself.

- E: □□: □□

Contact your Sony dealer or local authorized Sony service facility.

Code	Cause and/or Corrective Action
C:32:□□	<ul style="list-style-type: none">• There is trouble with the disc drive. → Turn the power off and on again.
C:13:□□	<ul style="list-style-type: none">• A disc not compatible with this camera is inserted or the data is broken. → Change the disc. (page 16)
E:61:□□ E:91:□□	<ul style="list-style-type: none">• A camera malfunction that you cannot repair has occurred. → Contact your Sony dealer or local authorized Sony service facility and inform them of the 5-digit indication. (example: E:61:10)

If you are unable to rectify the problem even if you try corrective actions a few times when C:□□:□□ is indicated, contact your Sony dealer or local authorized Sony service facility.

Specifications

System

Image device

MVC-CD200: 6.64 mm
(1/2.7 type) color CCD
MVC-CD300: 8.93 mm
(1/1.8 type) color CCD

Lens

3× zoom lens
MVC-CD200: $f = 6.1 - 18.3$ mm (1/4 - 3/4 inches)
(39 - 117 mm (1 9/16 - 4 5/8 inches) when converted into a 35 mm still camera)
MVC-CD300: $f = 7 - 21$ mm (9/32 - 27/32 inches) (34 - 102 mm (1 3/8 - 4 1/8 inches) when converted into a 35 mm still camera)
MVC-CD200: $F = 2.8 - 2.9$
MVC-CD300: $F = 2.0 - 2.5$

Exposure control

Automatic exposure, Shutter speed priority, Aperture priority, Manual exposure

White balance

Automatic, Indoor, Outdoor, One-push

Data system

Movie: MPEG1
Still: JPEG, GIF (in TEXT mode, Clip Motion), TIFF
Audio with still image: MPEG1 (Monaural)

Recording medium

8 cm CD-R/CD-RW

Recommended flash recording distance (ISO is set to AUTO):

MVC-CD200: 0.3 m to 2.5 m (11 7/8 inches to 8 1/3 feet)
MVC-CD300: 0.3 m to 3 m (11 7/8 inches to 9 feet 10 1/8 inches)

Drive

Read: Maximum ×8
Write: ×4

Readout

Noncontact optical readout (using semiconductor laser)

Laser

Wavelength: 777 to 787 nm
NA: 0.5
Maximum output: 23 mW
Emission duration: 600 ns

Input and Output connector

A/V OUT (MONO) (Monaural)

Minijack Video:
1 V_{p-p}, 75 Ω, unbalanced, sync negative
Audio: 327 mV (at a 47 kΩ load)

Output impedance: 2.2 kΩ

ACC jack

Mini-minijack (Ø 2.5 mm)

USB jack

mini-B

LCD screen

LCD panel

TFT (Thin Film Transistor active matrix) drive

LCD size

2.5 type

Total number of dots

123 200 (560×220) dots

General

Application

Sony battery pack NP-FM50 (supplied)

Power requirements

7.2 V

Power consumption (During shooting with the LCD backlight turned on)

MVC-CD200: 3.0 W
MVC-CD300: 3.5 W

Operating temperature

0°C to 40°C (32°F to 104°F)

Storage temperature

-20°C to +60°C (-4°F to +140°F)

Dimensions (Approx.)

MVC-CD200: 143×92×89 mm (5 3/4×3 5/8×3 5/8 inches) (w/h/d)
MVC-CD300: 143×92×94 mm (5 3/4×3 5/8×3 3/4 inches) (w/h/d)

Mass (Approx.)

MVC-CD200: 610 g (1 lb 6 oz)
MVC-CD300: 650 g (1 lb 7 oz) (including NP-FM50 battery pack, disc and lens cap, etc.)

Built-in microphone

Electret condenser microphone

Built-in speaker

Dynamic speaker

AC-L10A/L10B/L10C

AC power adaptor

Power requirements

100 to 240 V AC, 50/60 Hz

Rated output voltage

DC 8.4 V, 1.5 A in operating mode

Operating temperature

0°C to 40°C (32°F to 104°F)

Storage temperature

-20°C to +60°C (-4°F to +140°F)

Dimensions (Approx.)

125×39×62 mm (5×1 9/16×2 1/2 inches) (w/h/d)

Mass (Approx.)

280 g (10 oz)

NP-FM50 battery pack

Battery type

Lithium ion

Maximum output voltage

DC 8.4 V

Mean output voltage

DC 7.2 V

Capacity

8.5 Wh (1180 mAh)

Operating temperature

0°C to 40°C (32°F to 104°F)

Dimensions (Approx.)

38.2×20.5×55.6 mm

(1 9/16×13/16×2 1/4 inches)

(w/h/d)

Mass (Approx.)

76 g (3 oz)

Accessories

AC-L10A/L10B/L10C

AC power adaptor (1)

Power cord (mains lead) (1)

Ferrite Core (1)

USB cable (1)

NP-FM50 battery pack (1)

A/V connecting cable (1)

8 cm CD adaptor (1)

Mavica disc (2) (CD-R (1),

CD-RW (1))

Shoulder strap (1)

Lens cap (1)

Lens cap strap (1)

CD-ROM (2)

Operating instructions (2)

Design and specifications
are subject to change
without notice.

LCD screen indicators

The indicators during recording

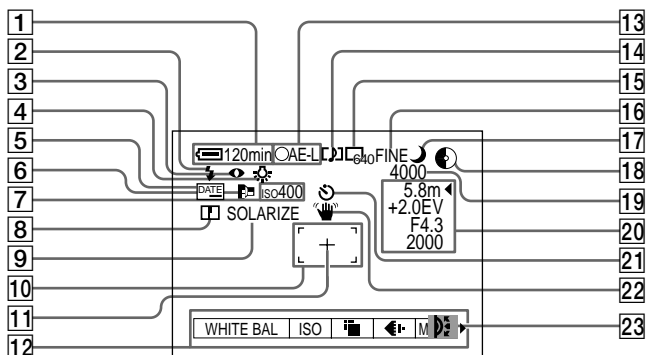

- | | |
|---|--|
| 1 Battery remaining indicator | 15 Image size indicator |
| 2 Flash level indicator/Flash mode indicator | 16 Image quality indicator |
| 3 Red-eye reduction indicator | 17 SCENE SELECTION indicator |
| 4 White balance indicator | 18 Remaining disc capacity indicator |
| 5 DATE indicator | 19 Remaining number of recordable images/Recording time indicator/Self-diagnosis function indicator |
| 6 AF illuminator indicator | 20 Manual adjustment indicators |
| 7 ISO number indicator | 21 Self-timer indicator |
| 8 Sharpness indicator | 22 Light amount warning indicator |
| 9 Picture effect indicator | 23 Jog dial indicator |
| 10 AF frame | |
| 11 Spot light-metering cross hair | |
| 12 Menu
Pressing MENU switches the menu on/off. | |
| 13 AE/AF lock indicator | |
| 14 Recording mode/Clip Motion indicator | |

The indicators during still image playback

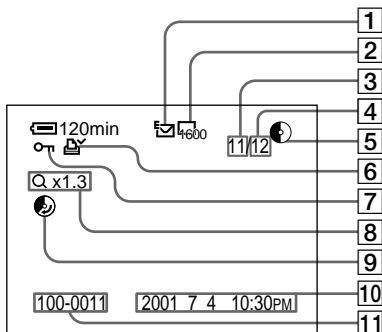

- 1** Recording mode/Clip Motion indicator
- 2** Image size indicator
- 3** Image number
- 4** Number of stored images on a disc
- 5** Remaining disc capacity indicator
- 6** Print mark indicator
- 7** Protect indicator
- 8** Zoom scaling indicator
- 9** Disc space recoverable indicator
- 10** Recording date of the playback image*
- 11** File name*

* When the menu is displayed, this indicator disappears from the screen.

The indicators during moving image playback

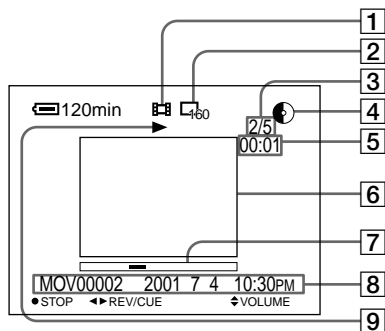

- 1** Recording mode indicator
- 2** Image size indicator
- 3** Image number/number of stored images on a disc
- 4** Remaining disc capacity indicator
- 5** Time counter
- 6** Playback image
- 7** Playback bar
- 8** Menu and guide menu
- 9** Playback/pause indicator
 - ▶ is displayed during playback, and ■ during stop.

Index

A

- AC power adaptor..... 10, 13
- ACC jack7
- Adjusting brightness
 - LCD screen.....22
- AE (auto exposure).....20
- Auto power-off function..21

B

- Battery pack
 - Charging10
 - Installing.....9
 - Remaining time10
 - Usable time.....11
- BEEP.....85

C

- Charging10
- Cleaning.....87
- Clip Motion.....64
- CLOCK SET.....14
- Control button.....46

D

- DELETE77
- DIGITAL ZOOM23
- Disc
 - Format82
 - Inserting.....16
 - Number of recordable images 54, 59, 60, 61, 62, 65
 - Usable type.....89
- DISC TOOL.....84
- DPOF.....81

E

- Editing
 - DELETE.....77
 - PROTECT78
- E-MAIL59
- EXP BRKTG63

F

- FILE NUMBER.....85
- FINALIZE32
- FLASH LEVEL.....50
- Focus preset66
- Focusing.....66

Printed on recycled paper

Printed using vegetable oil ink with less than 1% VOC (Volatile Organic Compound).

<http://www.world.sony.com/>

Sony Corporation Printed in Japan

- FORMAT82
- Full charge10

G

- GIF 44, 61, 64

I

- Image
 - Deleting77
 - File name43
 - Print mark81
 - Protect78
 - Size53
- Index screen72
- Indicators on the LCD screen.....105
- “InfoLITHIUM” battery pack9, 91
- INITIALIZE18

J

- Jog dial48
- JPEG20, 44

M

- Macro recording.....66
- Manual focusing66
- MOBILE mode64
- Mode dial45
- Moisture condensation.....87
- Moving image
 - Playback29
 - Recording26
- MPEG26, 44

N

- Number of recordable images
 - Clip Motion65
 - E-mail mode59
 - Image size54
 - TEXT mode61
 - TIFF mode.....62
 - VOICE mode.....60

P

- PICTURE EFFECT69
- Playing back
 - Index screen72
 - Moving images.....29
 - Slide show74
 - Still images.....28
 - Viewing images on a computer.....35

- Viewing images on a TV screen.....76

Power source

- AC power adaptor13
- Battery pack9
- PRINT MARK.....81
- PROTECT.....78

R

- REC MODE.....50
- Recording
 - Clip Motion64
 - E-mail mode59
 - In macro66
 - Moving image26
 - Still image20
 - TEXT mode.....61
 - TIFF mode.....62
 - VOICE mode.....60
 - With flash24
- RESIZE.....80
- ROTATE.....75

S

- SCENE SELECTION.....58
- Self timer24
- Self-diagnosis display...102
- SET UP84
- Setting the date and time..14
- SHARPNESS.....50
- Single display.....72
- SLIDE SHOW74
- Spot light-metering71
- Still image
 - Playback28
 - Recording.....20

T

- TEXT mode61
- TIFF44, 62

U

- UNFINALIZE.....34
- USB.....35
- Using flash24
- Using your camera abroad90

V

- Viewing images using a computer.....35
- VOICE60

W

- Warning messages100
- WHITE BALANCE.....68

Z

- Zoom.....22



3 0 6 7 9 5 1 1 2