

Digital Photo Frame

DPF-D82/D92

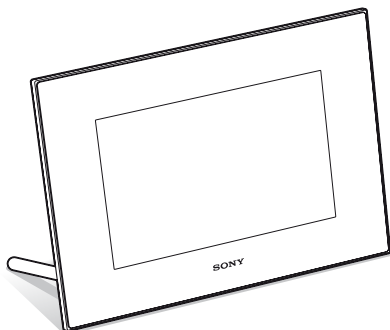

Operating Instructions

Before operating this unit, please read this manual thoroughly and retain it for future reference.

Owner's Record

The model and serial numbers are located at the rear.
Record the serial number in the space provided below. Refer to these numbers whenever you call upon your Sony dealer regarding this product.

Model No. DPF-D82/D92

Serial No. _____

Before operation

Basic operations

Advanced operations

Using an external device
(with Bluetooth)

Using an external device
(with a computer)

Error messages

Troubleshooting

Additional information



WARNING

To reduce fire or shock hazard, do not expose the unit to rain or moisture.

Do not expose the batteries to excessive heat such as sunshine, fire or the like.

CAUTION

Replace the battery with the specified type only. Otherwise, fire or injury may result. Dispose of used batteries according to the instructions.

For the customers in the U.S.A.

CAUTION

You are cautioned that any changes or modifications not expressly approved in this manual could void your authority to operate this equipment.

If you have any questions about this product, you may call:

*Sony Customer Information Services Center
1-800-222-SONY (7669)*

The number below is for the FCC related matters only.

Regulatory Information

Declaration of Conformity

Trade Name: SONY
Model No.: DPF-D92
Responsible Party: Sony Electronics Inc.
Address: 16530 Via Esprillo, San Diego,
CA 92127 U.S.A.
Telephone No.: 858-942-2230

This device complies with part 15 of the FCC Rules. Operation is subject to the following two conditions:

(1) This device may not cause harmful interference, and (2) this device must accept any interference received, including interference that may cause undesired operation.

Declaration of Conformity

Trade Name: SONY
Model No.: DPF-D82
Responsible Party: Sony Electronics Inc.
Address: 16530 Via Esprillo, San Diego,
CA 92127 U.S.A.
Telephone No.: 858-942-2230

This device complies with part 15 of the FCC Rules. Operation is subject to the following two conditions:

(1) This device may not cause harmful interference, and (2) this device must accept any interference received, including interference that may cause undesired operation.

Note:

This equipment has been tested and found to comply with the limits for a Class B digital device, pursuant to Part 15 of the FCC Rules.

These limits are designed to provide reasonable protection against harmful interference in a residential installation. This equipment generates, uses, and can radiate radio frequency energy and, if not installed and used in accordance with the instructions, may cause harmful interference to radio communications. However, there is no guarantee that interference will not occur in a particular installation. If this equipment does cause harmful interference to radio or television reception, which can be determined by turning the equipment off and on, the user is encouraged to try to correct the interference by one or more of the following measures:

- Reorient or relocate the receiving antenna.
- Increase the separation between the equipment and receiver.
- Connect the equipment into an outlet on a circuit different from that to which the receiver is connected.
- Consult the dealer or an experienced radio/TV technician for help.

For the State of California, USA only

Perchlorate Material - special handling may apply, See

www.dtsc.ca.gov/hazardouswaste/perchlorate

Perchlorate Material: Lithium battery contains perchlorate.

For the Customer in Europe

This product has been tested and found compliant with the limits set out in the EMC Directive for using connection cables shorter than 3 meters (9.8 feet).

Attention

The electromagnetic fields at the specific frequencies may influence the picture of this digital photo frame.

Notice

If static electricity or electromagnetism causes data transfer to discontinue midway (fail), restart the application or disconnect and connect the communication cable (USB, etc) again.

Disposal of Old Electrical & Electronic Equipment (Applicable in the European Union and other European countries with separate collection systems)



This symbol on the product or on its packaging indicates that this product shall not be treated as household waste. Instead it shall be handed over to the applicable collection point for the recycling of electrical and electronic equipment. By ensuring this product is disposed of correctly, you will help prevent potential negative consequences for

the environment and human health, which could otherwise be caused by inappropriate waste handling of this product. The recycling of materials will help to conserve natural resources. For more detailed information about recycling of this product, please contact your local Civic Office, your household waste disposal service or the shop where you purchased the product.

Disposal of waste batteries (applicable in the European Union and other European countries with separate collection systems)



This symbol on the battery or on the packaging indicates that the battery provided with this product shall not be treated as household waste. By ensuring these batteries are disposed of correctly, you will help prevent potentially negative consequences for

the environment and human health which could otherwise be caused by inappropriate waste handling of the battery. The recycling of the materials will help to conserve natural resources. In case of products that for safety, performance or data integrity reasons require a permanent connection with an incorporated battery, this battery should be replaced by qualified service staff only. To ensure that the battery will be treated properly, hand over the product at end-of-life to the applicable collection point for the recycling of electrical and electronic equipment. For all other batteries, please view the section on how to remove the battery from the product safely. Hand the battery over to the applicable collection point for the recycling of waste batteries.

For more detailed information about recycling of this product or battery, please contact your local Civic Office, your household waste disposal service or the shop where you purchased the product.

Notice for the customers in the countries applying EU Directives

The manufacturer of this product is Sony Corporation, 1-7-1 Konan Minato-ku Tokyo, 108-0075 Japan. The Authorized Representative for EMC and product safety is Sony Deutschland GmbH, Hedelfinger Strasse 61, 70327 Stuttgart, Germany. For any service or guarantee matters please refer to the addresses given in separate service or guarantee documents.

Duplication, edition, or printing of a CD, TV programs, copyrighted materials such as pictures or publications, or any other materials except for your own recording or creation is limited to private or domestic use only. Unless you hold copyright or have permission of copyright holders for the materials to be duplicated, use of those materials beyond this limit may infringe the provisions of the copyright law and be subject to the copyright holders claim for damages.

When using photo images with this digital photo frame, pay special attention not to infringe the provisions of the copyright law. Any unauthorized use or modification of there's portrait may also infringe their rights.

For some demonstrations, performances, or exhibits, photography may be forbidden.

Backup recommendations

To avoid potential risk of data loss caused by accidental operation or malfunction of the digital photo frame, we recommend that you save a backup copy of your data.

Information



IN NO EVENT SHALL SELLER BE LIABLE FOR ANY DIRECT, INCIDENTAL OR CONSEQUENTIAL DAMAGES OF ANY NATURE, OR LOSSES OR EXPENSES RESULTING FROM ANY DEFECTIVE PRODUCT OR THE USE OF ANY PRODUCT.

Sony shall assume no responsibility for any accidental or consequential damages or loss of the recording contents which may be caused by use or malfunction of the digital photo frame or memory card.

Notes on LCD screen

- Do not press against the LCD screen. The screen may be discolored and that may cause a malfunction.
- Exposing the LCD screen to direct sunlight for long periods may cause malfunctions.
- The LCD screen is manufactured using extremely high-precision technology, so over 99.99% of the pixels are operational for effective use. However, there may be some tiny black points and/or bright points (white, red, blue or green in color) that constantly appear on the LCD screen. These points are normal in the manufacturing process and do not affect the viewing in any way.
- Images may trail across on the LCD screen in a cold location. This is not a malfunction.

On trademarks and copyrights

- **S-Frame**, Cyber-shot, , "Memory Stick", **MEMORY STICK**, "Memory Stick Duo", **MEMORY STICK DUO**, "MagicGate Memory Stick", "Memory Stick PRO", **MEMORY STICK PRO**, "Memory Stick PRO Duo", **MEMORY STICK PRO DUO**, "Memory Stick PRO-HG Duo", **MEMORY STICK PRO-HG DUO**, "Memory Stick Micro", **MEMORY STICK MICRO**, **M2**, "Memory Stick-ROM", **MEMORY STICK-ROM**, "MagicGate", and **MAGIC GATE** are trademarks or registered trademarks of Sony Corporation.
- Microsoft, Windows, and Windows Vista are registered trademarks of Microsoft Corporation in the United States and/or other countries.
- Macintosh and Mac OS are registered trademarks of Apple Inc. in the United States and/or other countries.
- CompactFlash is a trademark of SanDisk Corporation in the U.S.A.
-  or xD-Picture Card™ is a trademark of FUJIFILM Corporation.
- The Bluetooth word mark and logos are owned by the Bluetooth SIG, Inc. and any use of such marks by Sony Corporation is under licence. Other trademarks and trade names are those of their respective owners.
- Contains iType™ and fonts from Monotype Imaging Inc. iType™ is a trademark of Monotype Imaging Inc.
- All other companies and product names mentioned herein may be the trademarks or registered trademarks of their respective companies. Furthermore, "™" and "®" are not mentioned in each case in this manual.
- This unit is equipped with face recognition feature. Sony Face Recognition technology developed by Sony is used.

Notice for users

Program © 2009 Sony Corporation
Documentation © 2009 Sony Corporation

All rights reserved. This manual or the software described herein, in whole or in part, may not be reproduced, translated or reduced to any machine readable form without prior written approval from Sony Corporation.

IN NO EVENT SHALL SONY CORPORATION BE LIABLE FOR ANY INCIDENTAL, CONSEQUENTIAL OR SPECIAL DAMAGES, WHETHER BASED ON TORT, CONTACT, OR OTHERWISE, ARISING OUT OF OR IN CONNECTION WITH THIS MANUAL, THE SOFTWARE OR OTHER INFORMATION CONTAINED HEREIN OR THE USE THEREOF.

Sony Corporation reserves the right to make any modification to this manual or the information contained herein at any time without notice. The software described herein may also be governed by the terms of a separate user license agreement.

Any design data such as sample pictures provided in this software cannot be modified or duplicated except for the purpose of personal use. Any unauthorized duplication of this software is prohibited under copyright law.

Please note that unauthorized duplication or modification of portraits or copyrighted work could infringe the rights reserved by rights holders.

On the illustrations and screen shots used in this manual

The illustrations and screen shots used in this manual are of the DPF-D92 unless noted otherwise.

The illustrations and screen shots used in this manual may not be identical to those actually used or displayed.

Table of Contents

Before operation

Enjoying your photo frame in various ways	8
Features	9
Checking included items	11
Identifying the parts	11

Basic operations

Preparing the remote control	15
Setting the stand	16
To display the photo frame on the wall	17
Connecting to the AC power source	18
Turning the photo frame on	19
Setting the current time	20
Inserting a memory card	21
Changing the display	23
Slideshow display	24
Clock and calendar display	25
Single view mode	26
Index image display	27

Advanced operations

Enjoying a slideshow	29
Changing the settings of the slideshow	29
Refresh mode	32

Adding images to the internal memory	32
Exporting an image	34
Deleting an image	36
Registering a mark	37
Searching for an image (Filtering)	39
Specifying the playback device	40
Adjusting the image size and position	40
Enlarging/reducing an image	40
Rotating an image	41
Changing the settings of the auto power on/off function	42
Using the alarm function	43
Setting the alarm	43
Setting the time to be alarmed	44
Changing the settings	44
Setting procedure	44
Items to set	46
Displaying images on a USB memory	48

Using an external device (with Bluetooth)

Transferring images using Bluetooth	49
---	----

Using an external device (with a computer)

Connecting to a computer	51
System requirements	51

Connecting to a computer to exchange images51
Disconnecting your computer52

Error messages

If an error message appears53

Troubleshooting

If trouble occurs55

Additional information

Precautions60
 Safety60
 Installation60
 Cleaning60
 Restrictions on duplication61
 Disposing of the photo frame61
About memory cards61
 “Memory Stick”61
 SD memory card62
 xD-Picture Card62
 CompactFlash card62
 Notes on using a memory card63
Specifications64
Index66

Enjoying your photo frame in various ways

The Sony DPF-D82/D92 is a digital photo frame for easily displaying images taken with a digital camera or other device, without using a computer.

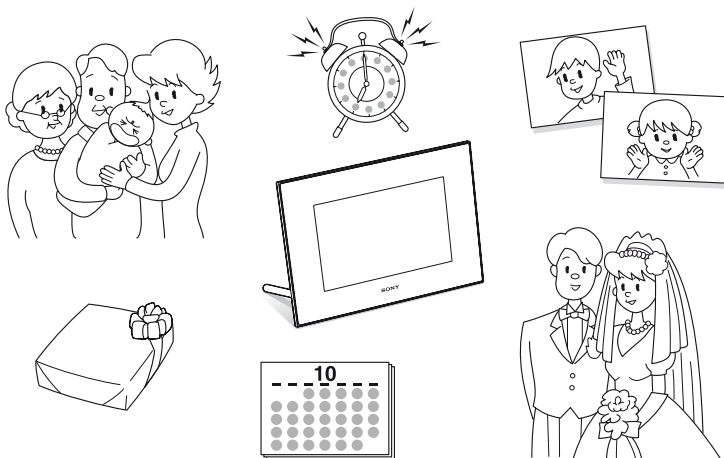

Features

■ Support for various memory cards*

Supports various memory cards and other devices, such as a “Memory Stick”, CompactFlash card, SD memory card, xD-Picture Card, and USB memory. Just insert a memory card removed from a digital camera or other device, and you will be able to view the images immediately. (➡ page 21, 48)

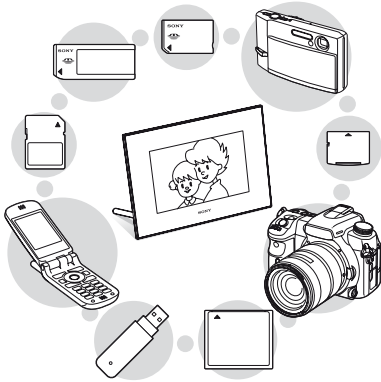

■ Various display functions

You can enjoy various viewing modes, such as the slideshow display, Clock and calendar display, Single view mode, and Index image display. (➡ page 23)



■ Various modes

The displayed image can be switched automatically as though you are turning the pages of an album yourself. You can select from various modes, including just images, a clock, or calendar view. You can also change playback settings such as the playback order. (➡ page 29)

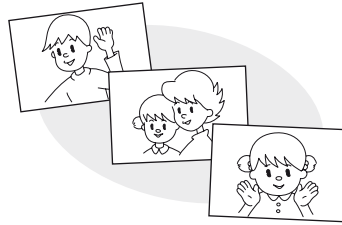

■ Adding images to internal memory

The images you add to the album are saved in internal memory. (➡ page 32)

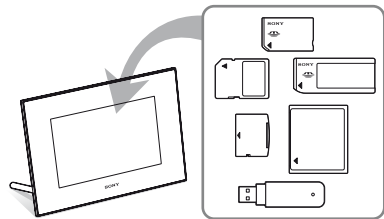

■ Exporting images

You can export images in the album to your memory card. (➡ page 34)

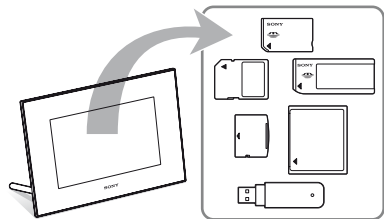

■ Search function

You can search for images by the date, folder, image direction, and mark.

(➡ page 39)

■ Alarm function

The photo frame announces the specified time on the image and using sound.

(➡ page 43)

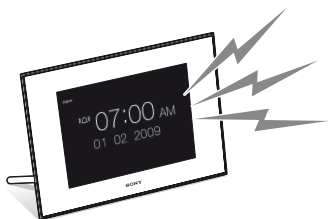

■ Automatic rotation of images

The photo frame automatically rotates images to their proper orientation. Images are also automatically rotated when the photo frame is set in either the portrait or landscape position. (➡ page 16)

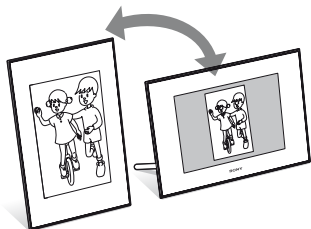

■ Easy transfer of images taken with a Bluetooth compatible mobile phone or other device*

You can transfer images to the photo frame's internal memory from a Bluetooth compatible device via a Bluetooth adaptor (optional). (➡ page 49)

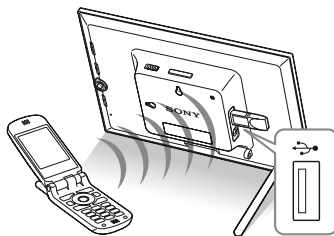

■ Displaying images on a wall

You can hang the photo frame on the wall.

(➡ page 17)

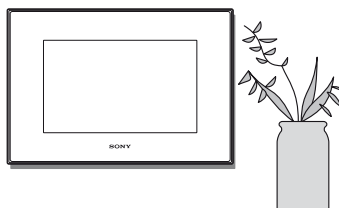

* We do not guarantee proper operations for all types of devices.

Checking included items

Make sure that the following items are included.

- Digital photo frame (1)
- Stand (1)
- Remote control (1)
- AC adaptor (1)
- Operating Instructions (this manual) (1)
- Read This First (1)
- Warranty (1)
(In some regions, the warranty is not supplied.)

Identifying the parts

For details, see the pages indicated in the parentheses.

The illustrations and names of buttons and connectors of the DPF-D82 are identical to those of the DPF-D92, although the LCD screen size and shape is different.

Front

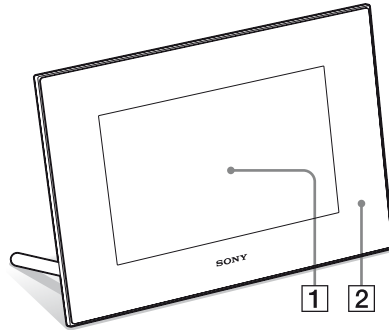

1 LCD screen

2 Remote sensor

When using the supplied remote control, point it at this sensor.

Rear

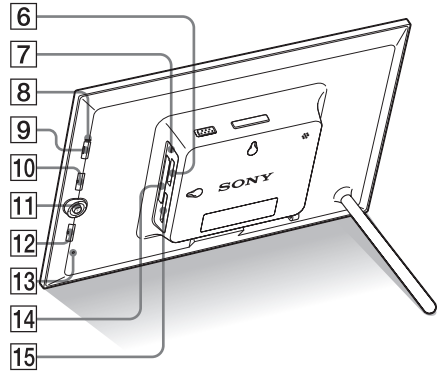
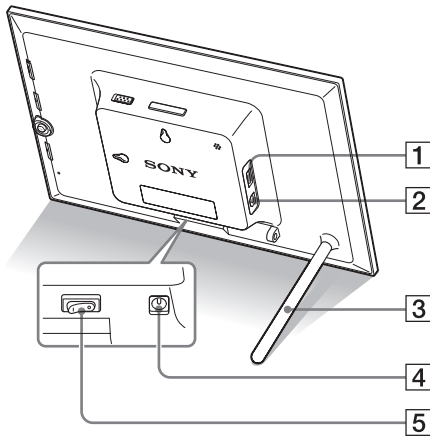

1 Connector for USB A/Bluetooth adaptor (→ page 49)

Connect a Bluetooth adaptor (optional: DPPA-BT1) when you want to transfer images wirelessly from a BLUETOOTH compatible mobile phone or digital camera. You can also connect a USB memory compatible with USB mass storage.

2 USB B connector (→ page 51)

Connect a USB cable when you want to use the photo frame with a computer.

3 Stand (→ page 16)

4 DC IN 12 V jack (→ page 18)

Insert the plug of the supplied AC adaptor to this jack, and connect to the wall outlet.

5 Power Switch (→ page 19)

6 “Memory Stick PRO” (Standard/Duo) slot (→ page 21)

7 Access lamp





8 Standby indicator





9  (on/standby) button

10 MENU button

Displays the menu.

From the menu, you can operate the same functions as those of the buttons on the remote control, such as [Slideshow Settings], [Rotate], [Add to album] and [Date/time settings].

11 Direction (///) buttons, 

Press /// to select the menu items. Then press  to enter the selection.

12 BACK button

Returns to the previous screen.

13 Reset switch (→ page 58)

The date/time setting, alarm settings, and the auto power on/off settings return to their factory default setting. Use a long, thin object, such as a pin, to push the switch.

14 CompactFlash card/Microdrive slot (→ page 21)

15 SD memory card/MMC/xD-Picture Card slot (→ page 21)

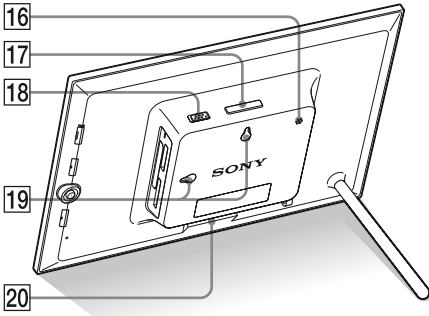

- 16 Buzzer
- 17 VIEW MODE button (→ page 23)
- 18 Alarm switch (→ page 43)
- 19 Holes for hanging unit on the wall (→ page 17)
- 20 Space for storing the stand

Remote control

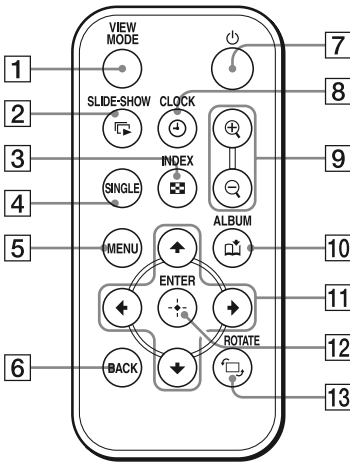

- 1 VIEW MODE button (→ page 23)
- 2 SLIDE-SHOW (↔) button (→ page 23)
- 3 INDEX (☐) button (→ page 23)
- 4 SINGLE (SINGLE) button (→ page 23)
- 5 MENU button
- 6 BACK button
- 7 ⏻ (on/standby) button
- 8 CLOCK (🕒) button (→ page 23)
- 9 Zoom in (🔍)/Zoom out (🔍) buttons (→ page 40)
- 10 ALBUM (📁) button (→ page 32)
- 11 Direction (←/→/↑/↓) buttons
- 12 ⏏ (enter) button
- 13 ROTATE (↻) button (→ page 40)

Preparing the remote control

The supplied lithium battery (CR2025) has already been inserted into the remote control. Pull out the protective sheet before use as shown in the figure.

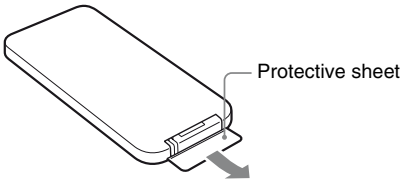

Using the remote control

Point the top end of the remote control towards the remote sensor on the photo frame.

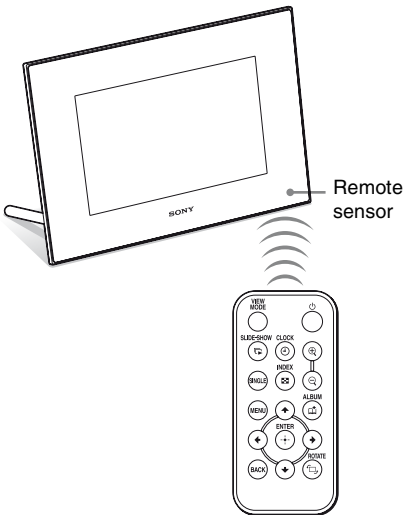

Note

The photo frame may fall if you use the buttons on the photo frame when it is hanging on the wall. Operate the photo frame using the remote control.

Replacing the battery of the remote control

If the remote control stops working, replace the battery (CR2025 lithium battery) with a new one.

- 1 Pull out the battery holder. While pressing in the tab of the battery holder, pull out the battery holder.

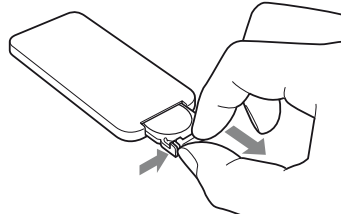

- 2 Remove the old battery from the battery holder and then insert a new battery. Insert the battery so that "+" is facing upwards.

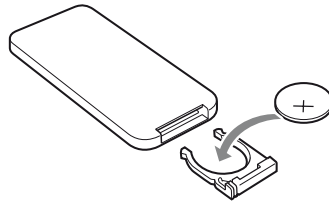

- 3 Reinsert the battery holder into the remote control.

WARNING

Battery may explode if mistreated. Do not recharge, disassemble or dispose of in fire.

Notes

- When the lithium battery becomes weak, the operating distance of the Remote control may shorten, or the Remote control may not function properly. In this case, replace the battery with a Sony CR2025 lithium battery. Use of another battery may present a risk of fire or explosion.

- Using a battery other than the specified one may result in the battery rupturing.
- Dispose of used batteries as specified by the local authorities.
- Do not leave the remote control in a very hot and humid place.
- Take care that no foreign objects get inside the remote control when you, for example, replace the battery.
- Incorrect use of the battery may cause leaking and corrosion.
 - Do not recharge the battery.
 - When the remote control will not be used for a long period of time, remove the battery from the remote control to prevent leaking and corrosion.
 - Incorrectly inserting, shorting, dismantling, or heating the battery, or throwing it into a fire may cause the battery to rupture or leak.

About descriptions in this manual

The operations described in this manual are based on remote control operation. When an operation is performed differently, for example, with the remote control and the buttons on the photo frame, it will be explained in a tip.

Setting the stand

- 1 Hold the photo frame tightly and insert the stand straight into the screw hole on the rear panel.

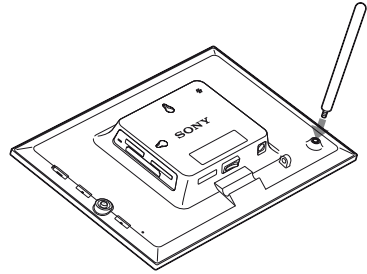

- 2 Screw the stand into the screw hole firmly until the stand stops turning.

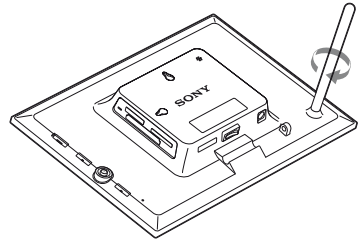

Setting to portrait or landscape orientation

You can set the photo frame to portrait or landscape orientation by rotating it without moving the stand.

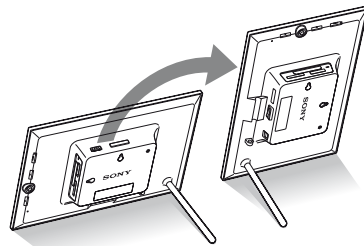

When the photo frame is placed in the portrait orientation, the image is also automatically rotated to its proper orientation.

The directions indicated on the direction button on the rear panel depend on the orientation of the photo frame.

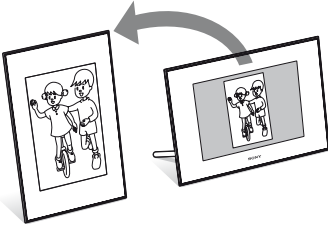

Notes

- Check whether the stand is stable. If the stand is not set properly, the photo frame may fall over.
- When the photo frame is placed in the portrait orientation, the Sony logo doesn't light up.
- The photo frame does not detect and rotate the orientation of images when [Auto display orientation] of [General Settings] on the  (Settings) tab is set to [OFF].
- A magnet is contained in the storage portion of the stand. Do not keep anything that is easily affected by magnetism, such as a cash card or credit card, near the photo frame. If you place the photo frame near a CRT-based television, the color of the TV's display may be changed.

Tip

It is easier to turn the stand if you wind or wrap a rubber band tightly around the stand when you remove the stand from the photo frame.

To display the photo frame on the wall

You can hang the photo frame on the wall using the following procedure.

- 1 Prepare screws (not supplied) suitable for the screw holes on the rear panel.

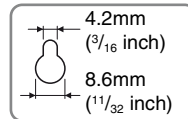
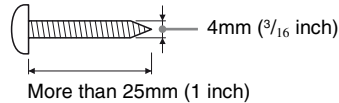

Holes for hanging the unit on the wall

- 2 Screw the screws (not supplied) into the wall.

Be sure the screws (not supplied) protrude between 2.5 to 3mm ($1/8$ inch) from the surface of the wall.

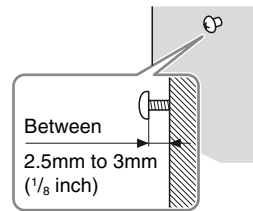

- 3 Hang the photo frame on the wall by fitting the hole on the rear panel to the screws on the wall.

Notes

- Use screws suitable for the quality of the material of the wall. The screws may be damaged, depending on the type of material used in the wall. Set the screws in a pillar or stud in the wall.

Continued

- When you want to re-insert the memory card, remove the photo frame from the wall, then eject and re-insert the memory card while the photo frame is placed on a stable surface.
- Store the stand in the place provided when you hang the photo frame on the wall.
- Connect the plug of the supplied AC adaptor to the photo frame and set the power switch to ON. And then connect the AC adaptor to the wall outlet after hanging the photo frame on the wall.
- We take no responsibility for any accidents or damage caused by defects of attachment, misuse, or natural disasters, etc.

Connecting to the AC power source

- 1 Insert the plug of the AC adaptor into the DC IN 12 V jack on the rear of the photo frame.
- 2 Connect the AC adaptor to the wall outlet.

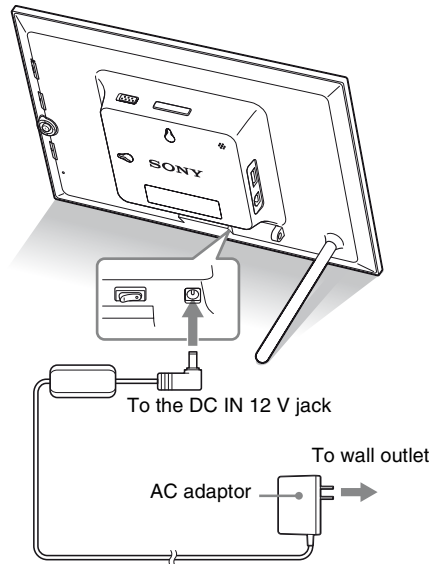

Notes

- The socket outlet should be as close as possible to the unit, and easily accessible.
- Do not place the photo frame in an unsteady location such as on an unsteady table or tilted surface.
- Connect the AC adaptor to an easily accessible wall outlet close by. If trouble occurs while using the adaptor, immediately shut off the power by disconnecting the plug from the wall outlet.
- Do not short the plug of the AC adaptor with a metal object. Doing so may cause a malfunction.
- Do not use the AC Adaptor placed in a narrow space, such as between a wall and furniture.

- Insert the plug of the AC adaptor firmly, if the connection is loose, the photo frame may turn off when it is moved.
- After use, remove the AC adaptor from the DC IN 12 V jack of the photo frame, and remove the AC adaptor from the outlet.
- Even if your photo frame is turned off, AC power (house current) is still supplied to it while connected to the wall outlet via the AC adaptor.
- Do not turn the photo frame off or disconnect the AC adaptor from the photo frame before the standby indicator turns red. Doing so may damage the photo frame.

Turning the photo frame on

When the power switch is set to off

When the power switch is set to on, the standby indicator turns green and the Sony logo on the front panel lights up.

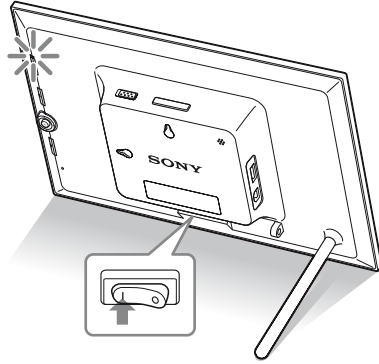

When the power switch is set to on

Press  (on/standby) on the photo frame or remote control to turn on the power. The standby indicator turns to green from red. The Sony logo on the front panel lights up.

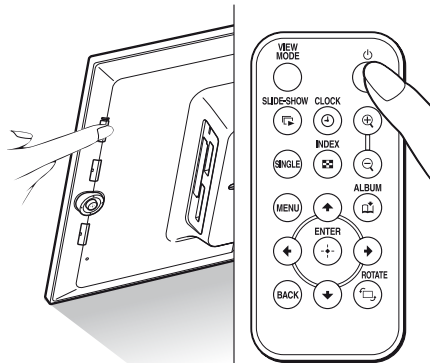

Continued

Turning off the power

Hold \odot (on/standby) on the photo frame or remote control until the power turns off. The standby indicator turns to red from green.

Note

Do not turn the photo frame off or disconnect the AC adaptor from the photo frame before the standby indicator turns red. Doing so may damage the photo frame.

Operations in an initial state

When the photo frame is turned on without a memory card connected, the initial display below appears on the screen.

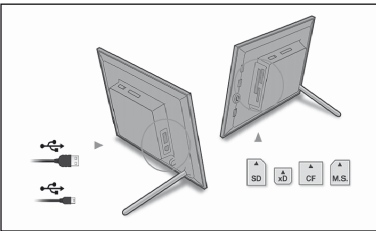

If the photo frame is not operated for 10 seconds, the demo mode is displayed. If any other button than the power button is pressed, the screen returns to the initial display.

First, press MENU during the initial display, and then set the date and time.

Setting the current time

The clock of the photo frame needs to be adjusted in order to display an accurate time in the clock and calendar view modes.

- 1 Press MENU.
The menu screen is displayed.
- 2 Press \leftarrow/\rightarrow to select the  (Settings) tab.
The settings screen is displayed.

Tip

You can use the \leftarrow/\rightarrow button only when a memory card is inserted in the photo frame, an external device is connected, or anything other than the clock and calendar settings item (page 25) are selected.

- 3 Press \downarrow/\uparrow to select [Date/time settings] and then press \oplus .
The Date/time settings screen is displayed.

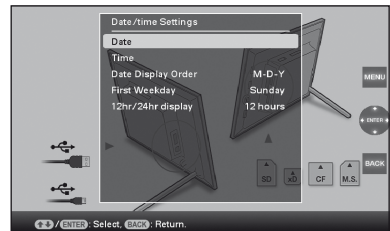

- 4 Adjust the date.
 - ① Press \downarrow/\uparrow to select [Date] and then press \oplus .
 - ② Press \leftarrow/\rightarrow to select month, day, and year, and then press \downarrow/\uparrow to select a value, then press \oplus .
- 5 Adjust the time.
 - ① Press \downarrow/\uparrow to select [Time] and then press \oplus .
 - ② Press \leftarrow/\rightarrow to select hour, minute, and second, and then press \downarrow/\uparrow to select a value, then press \oplus .

- 6** Select the format of the date.
- ① Press $\blacktriangledown/\blacktriangle$ to select [Date Display Order] and then press \oplus .
 - ② Press $\blacktriangledown/\blacktriangle$ to select a format and then press \oplus .
 - Y-M-D
 - M-D-Y
 - D-M-Y

- 7** Set the day to start the week for the calendar.

You can set the day that appears on the very left when the calendar is displayed.

- ① Press $\blacktriangledown/\blacktriangle$ to select [First Weekday] and then press \oplus .
- ② Press $\blacktriangledown/\blacktriangle$ to select [Sunday] or [Monday] and then press \oplus .

- 8** Select the time display.

- ① Press $\blacktriangledown/\blacktriangle$ to select [12hr/24hr display] and then press \oplus .
- ② Press $\blacktriangledown/\blacktriangle$ to select [12 hours] or [24 hours] and then press \oplus .

- 9** Press MENU.

The menu screen is closed.

Inserting a memory card

Insert the memory card firmly into the corresponding slot with its label side facing toward you (when you are facing the back side of the photo frame).

The access lamp flashes when the memory card is inserted correctly. Reinsert the memory card after checking the label side of the memory card if the access lamp does not flash.

For details on the memory cards you can use with this photo frame, see pages 61 to 63.

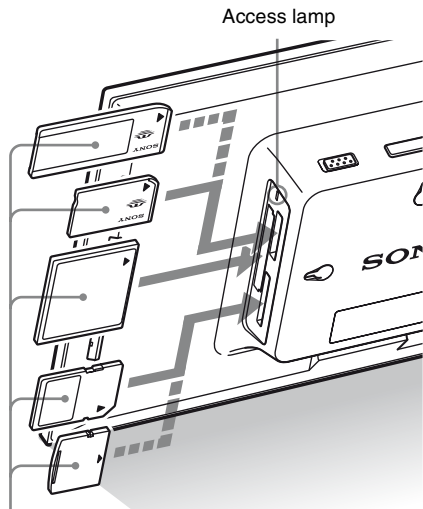

Insert the memory card firmly into the corresponding slot with its label side facing toward you. The slot order from the top is "Memory Stick" ("Memory Stick Duo"), CompactFlash card, SD memory card and xD-Picture Card.

To remove a memory card

Remove the memory card from its slot in the opposite direction from which it was inserted.

Notes

- When inserting the memory card, it will only insert part of the way, so do not try to force it as this could damage the memory card and/or photo frame.
- This photo frame has a slot that is both a “Memory Stick” standard and Duo size compatible slot, so you do not need a “Memory Stick” adaptor.
- The SD memory card/xD-Picture Card dual-purpose slot automatically detects the card type.
- Before using a memory card, see “About memory cards” on page 61.

Display priority of images

If a memory card is inserted or an external device is connected, the images of the inserted memory card or connected device are displayed automatically.

To manually change the memory card or external device to be displayed, specify it in  (Select device) menu (page 40).

The photo frame displays the images of the memory card in the following priorities.

- **Memory card / The device connected to the USB A/Bluetooth connector** → **internal memory**
- **If multiple memory cards are inserted when the photo frame is turned on**, the images of the first memory card you inserted take priority and are displayed.
- **If multiple devices are inserted while the photo frame is turned off, and then the photo frame is turned on**, the images of the device displayed when the photo frame is turned off take the first priority and are displayed. A device connected to the USB A/Bluetooth connector, however, may not be able to take priority.
- **If a memory card is replaced while the photo frame is turned off, and then the photo frame is turned on**, the images are displayed in the following priorities:
“Memory Stick” → CompactFlash card
→ SD memory card → xD-Picture Card → the device connected to the USB A/Bluetooth connector → internal memory
- **If no memory card is inserted and no device is connected**, the images saved in the album in the internal memory are displayed.

Notes



- Due to one of the characteristics of the internal memory device, images stored for long time or read many times may be subject to data error when read too often.
- For the file formats that the photo frame can display, see page 64.

Changing the display

- 1 Press VIEW MODE.
The view mode screen is displayed.



- 2 Select the group you want.

Group	Explanation
 Slide show	Displays a slideshow display style.
 Clock and calendar	Displays a clock or calendar style.
SINGLE	Displays a single image style.
 Index	Displays a thumbnail list style.

Tip

Select the group you want using \leftarrow/\rightarrow after moving the cursor to the group area using $\leftarrow/\rightarrow/\downarrow/\uparrow$, when you operate the photo frame using the buttons on the photo frame.

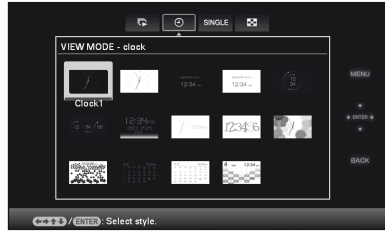

- 3 Press $\leftarrow/\rightarrow/\downarrow/\uparrow$ or VIEW MODE to select the style you want and then press \oplus .

Note

If you have not operated the photo frame for an extended period of time, the style the cursor is on will be selected automatically.

Slideshow display

Group	Image	Style	Explanation
 Slideshow	A	Single view	Displays one image after another.
	B	Multi image view	Displays multiple images at the same time.
	C	Clock view	Displays images with the present date and time.
	D	Calendar view	Displays images, one after another, while showing a calendar. The present date and time is displayed.
	E	Time Machine	Displays images with the shooting date and time. The present date and time cannot be displayed.
	F	Random view	Displays images while randomly switching between a number of different slideshow styles and effects.

A



B



C



D



E



F



Tips

- If the power is on, and no memory card is inserted, and no device is connected, the images stored in internal memory are displayed. If no images are saved in internal memory, demonstration mode starts automatically. Demonstration mode ends if a button other than  (on/standby) is pressed.
- For details on the playback order in a slideshow display, see page 46.

- You can set the interval, effect, listing order, or color effect when you select the slideshow display. Refer to “Slideshow Settings” (page 31).
- You can select the single view mode when you press  on the photo frame when the image you want appears in the slideshow display.
- You can use the VIEW MODE button on the photo frame.

Clock and calendar display



Clock1

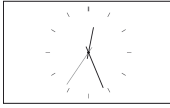

Clock2

Clock3



Clock4

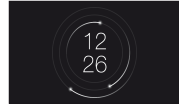

Clock5

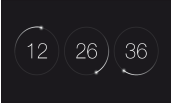

Clock6



Clock7



Clock8



Clock9

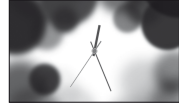

Clock10



Clock11



Calendar1



Calendar2



Calendar3

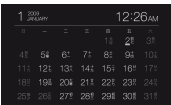

Lunar Calendar
(when you select
[Simplified
Chinese] in
[Language setting])



Arabic Calendar
(when you select
[Arabic] in
[Language setting])



Farsi Calendar
(when you select
[Persian] in
[Language setting])

Note

You can select only the  (Settings) tab when the Clock and calendar display is displayed.

Tip

You can use the VIEW MODE button on the photo frame.

Single view mode

Group	Image	Style	Explanation
SINGLE	A	Entire image	Displays an entire image in the screen. You can switch the images to be displayed by pressing \leftarrow/\rightarrow .
	B	Fit to screen	Displays an image over the whole screen. You can switch the images to be displayed by pressing \leftarrow/\rightarrow .
	C	Entire image (with Exif)	Displays image information, such as the image number, file name, and shooting date while displaying the entire image. You can switch the images to be displayed by pressing \leftarrow/\rightarrow . Refer to “About the information display” (page 28) for details on the image information.
	D	Fit to screen (with Exif)	Displays image information, such as the image number, file name, and shooting date in fit to screen mode. You can switch the images to be displayed by pressing \leftarrow/\rightarrow . Refer to “About the information display” (page 28) for details on the image information.

A



B



C



D



Tips

- If the power is on, and no memory card is inserted, and no device is connected, the images stored in internal memory are displayed. If no images are saved in internal memory, demonstration mode starts automatically. Demonstration mode ends if a button other than \odot (on/standby) is pressed.
- You can set the image display mode by pressing VIEW MODE and pressing \leftarrow/\rightarrow to select either entire image or fit to screen mode. Not all images are able to use the fit to screen mode.
- You can use the VIEW MODE button on the photo frame.

Index image display

Group	Image	Style	Explanation
Index	A	Index 1	Displays a list of large thumbnails. You can select an image by pressing $\leftarrow/\rightarrow/\downarrow/\uparrow$.
	B	Index 2	Displays a list of thumbnails. You can select an image by pressing $\leftarrow/\rightarrow/\downarrow/\uparrow$.
	C	Index 3	Displays a list of small thumbnails. You can select an image by pressing $\leftarrow/\rightarrow/\downarrow/\uparrow$.

A



B



C



Tips

- A thumbnail is a small-sized image for index use that is recorded in the pictures taken by a digital camera.
- If the power is on, and no memory card is inserted, and no device is connected, the images in internal memory are displayed. If no images are saved in internal memory, demonstration mode starts automatically. Demonstration mode ends if a button other than ⏻ (on/standby) is pressed.
- You can select the single view mode when you press ⏻ on the photo frame when the image you want appears in the index image display.
- You can use the VIEW MODE button on the photo frame.

About the information display

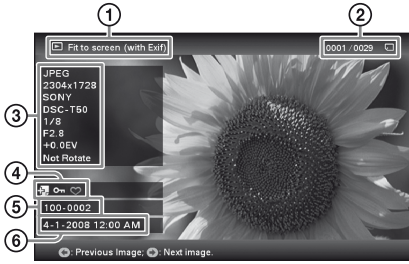

The following information is displayed.

- ① Display type
 - Entire image
 - Fit to screen
 - Entire image (with Exif)
 - Fit to screen (with Exif)
- ② Ordinal number of the displayed image/Total number of images
Input media indication for the displayed image is shown as follows:

Icons	Meaning
	“Memory Stick” input
	SD Memory Card input
	CompactFlash input
	xD-Picture Card input
	External Device input
	Internal memory input

- ③ Image details
 - File format (JPEG(4:4:4), JPEG(4:2:2), JPEG(4:2:0), RAW)
 - Number of pixels (width × height)
 - Manufacturer name of image input device
 - Model name of image input device
 - Shutter speed (e.g.: 1/8)
 - Aperture value (e.g.: F2.8)
 - Exposure value (e.g.: +0.0EV)
 - Rotation information

④ Setting information

Icons	Meaning
	Protect indication
	Associated file indication (Displayed when there is an associated file such as a motion file or a miniature e-mail image file.)
	Displays when you have registered a mark.

- ⑤ Image number (folder-file number)
This is displayed if the image is DCF compliant.
If the image does not comply with DCF, up to 10 characters of its file name are displayed.
- ⑥ Shooting date/time







Enjoying a slideshow

You can display images stored in the internal memory or on a memory card, one after another, automatically.





When you turn on the photo frame, the slideshow plays continuously from the previous play.

- 1 Press VIEW MODE.
The view mode screen is displayed.
- 2 Select  (slideshow).

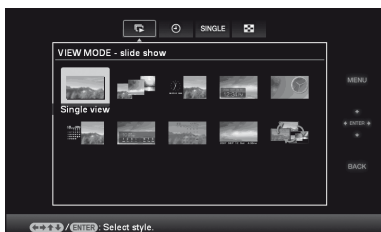
Tip

Select  (slideshow) using / after moving the cursor to the group area using // when you operate the photo frame using the buttons on the photo frame.





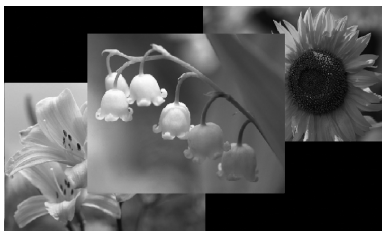



- 3 Press /// to select the style you want, then press .





Refer to “Slideshow display” (page 24) for details on the slideshow styles.

Changing the settings of the slideshow

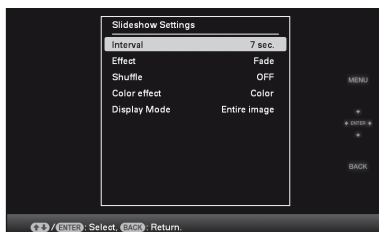
- 1 Press MENU.
The menu is displayed.
- 2 Press / to select the  (Settings) tab.
The settings screen is displayed.
- 3 Press / to select [Slideshow Settings] and then press .
The slideshow settings screen is displayed.



- 4 Press / to select the item and then press .
- Refer to the tables on the next page for details on the setting items.

Notes

- Note the following when you select a slideshow using the image stored on the memory card.
 - Due to one of the characteristics of the memory card devices, images may be subject to data error when read too often.
 - Do not run a slideshow for a long time with a small number images. This may cause data error.
 - We recommend you back up images on the memory card often.
- When the photo frame is, for instance, displaying a slideshow, changes to the settings of some items are unavailable. These items are displayed in gray and cannot be selected.
- The slideshow starts from the first image if you set the power switch to OFF before entering the standby mode, if you reset the photo frame.

- When the screen is too bright, it may make you feel nauseous. Be careful that you do not make the brightness settings too bright when you use the photo frame.

Tip

You can also use the VIEW MODE button on the photo frame.

*: Factory default settings

Item	Setting	Description	
Slideshow Settings	Interval	Set a value from 3 sec., 7 sec.*, 20 sec., 1 min., 5 min., 30 min., 1 hour, 3 hours, 12 hours, 24 hours for the interval between images. Note An image may not switch at the intervals you set on the menu, depending on the style of the slideshow, color effect, or image size.	
	Effect	Center cross	Transitions to the next image as though the previous image is being pushed from the center to the four corners.
		Vert. blinds	Transitions to the next image as though blinds are being lowered vertically.
		Horiz. blinds	Transitions to the next image as though blinds are being pulled horizontally.
		Fade*	Transitions to the next image by fading out the current image and fading in the next image.
		Wipe	Transitions to the next image as though the current image is being wiped off the screen to reveal the next image.
		Random	Uses the above five effects randomly.
	Shuffle	ON	Displays images randomly.
		OFF*	Displays images according to the [Listing Order] setting of [General Settings].
	Color effect	Color*	Displays an image in color.
		Sepia	Displays an image in a sepia color.
		Monochrome	Displays an image in monochrome.
	Display Mode	Select the desired display size from the following: Note The original image data will not change.	
		Entire image*	Displays an entire image enlarged to proper size. (An image may be displayed with margins on the top, bottom, left and right.)
		Fit to screen	Zooms in at the center of the image enough to fill the whole screen. Note An image may not display with the display size you set on the menu, depending on the style of the slideshow.

Refresh mode

Due to one of the characteristics of the device, images stored for a long time or read many times may be subject to data error when read too often.

This photo frame refreshes the internal memory automatically to prevent these errors, depending on the status of the internal memory.

The confirmation screen used for refreshing the internal memory is displayed automatically when the refresh is needed.

The refresh starts when you select [OK]. The Refresh also starts automatically when no operation is attempted for 30 seconds. If you select [Cancel], the confirmation screen used for refreshing the internal memory is displayed the next time.

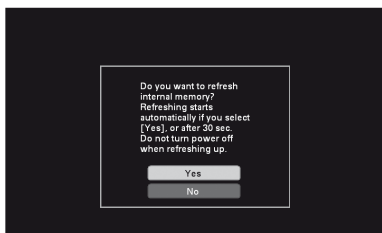

Do not turn the photo frame to OFF while the internal memory is being refreshed. It may cause a malfunction.

It may take approximately 5 minutes to refresh the internal memory.

Notes

- We recommend that you perform a backup of your data periodically to avoid losing it.
- Do not run a slideshow with less than 10 images continuously if you have set the interval time for the slideshow to 3 seconds. You may not be able to protect some images in the internal memory.

Adding images to the internal memory

You can use the photo frame as a digital album, saving important images in the internal memory.





Tip

In [Image file size] of the menu, you can preset whether to optimize the size of images or save images as is, without compressing them, when you save them to the internal memory (page 46).

When [Image file size] is set to [Album], up to approx. 2,000 images can be added to the album. When set to [Original], the number of images that can be saved may vary, depending on the original image file size.

- 1 Press  (Album) when an image stored on the memory card or the external device is displayed on the screen.

Tip

Select [Add to album] using / after pressing the MENU button and then select  (Editing) using /.

Single image display

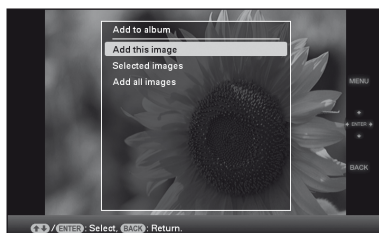

Slideshow display

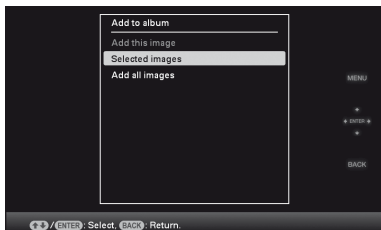

Index image display



- 2** Press \downarrow/\uparrow to select [Add this image], [Selected images] or [Add all images] and then press \oplus .

If you select [Add this image], the image currently displayed is added to the album. Go to step 4. (This item cannot be selected on the slideshow display.)

If you select [Selected images], you can select the image you want to add from the image list. Go to step 3.

If you select [Add all images], the image list is displayed. A check mark is attached to the check box of all the images. Go to step 4.

- 3** Specify the image to add from the image list.

About the image list

During a search: Displays all the images applicable to the criteria used for the search.

Other than during a search: Displays all images in the device displayed on the screen.

Refer to “Searching for an image (Filtering)” (page 39).

- 1** Press $\leftarrow/\rightarrow/\downarrow/\uparrow$ to select the image to add to the album and then press \oplus . A check mark will be attached to the check box of each selected image. Repeat this operation to add multiple images at the same time.



To cancel the selection, select images to cancel and then press \oplus to delete the check mark in the check box.

- 2** Press MENU.

The confirmation screen used for selecting a folder is displayed.

- 4** Press \downarrow/\uparrow to select the folder you want and press \oplus .

The confirmation screen used to decide whether to add an image or not to the internal memory is displayed.

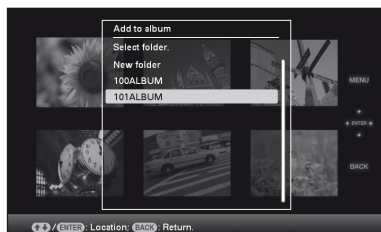

Tip

A new folder is created automatically when you select [New folder].

- 5** Press \downarrow/\uparrow to select [Yes] and then press \oplus .

The image is saved in the specified folder in internal memory.

- 6** Press **+** when the confirmation screen is displayed.

Notes

- Images in the internal memory cannot be added to the album.
- Do not turn off the power, remove the memory card, or disconnect the external device while an image is being added. Doing so may damage the photo frame or memory card, or damage the data.

Tips

- To perform this operation using the remote control, press the MENU button on the remote control and then press **▼/▲** to select [Add to album] from **☰** (Editing) and then press **+**.
- You can also use the MENU button on the photo frame.
- You can change the thumbnail size using **Ⓢ/Ⓡ** in the image list.
- Due to one of the characteristics of the internal memory device, images stored for long time or read many times may be subject to data error when read too often. We recommend that you perform a backup of your data periodically to avoid losing it.

Exporting an image

You can export the images in the internal memory to a memory card or external device.

- 1** Press MENU when an image stored on the internal device is displayed on the screen.
The menu is displayed.
- 2** Press **↔** to select the **☰** (Editing) tab.
The screen used for editing is displayed.
- 3** Press **▼/▲** to select [Export] and then press **+**.
The Export menu is displayed.

Single image display



- 4** Press **▼/▲** to select [Export this image], [Selected images] or [Export all images] and then press **+**.
If you select [Export this image], the image currently displayed is exported to the device. Go to step 6. (This item cannot be selected on the slideshow display.)
If you select [Selected images], you can select the image you want to export from the image list. Go to step 5.
If you select [Export all images], the image list is displayed. A check mark is attached to the check box of all the images. Go to step 6.

5 Specify the image to export from the image list.

About the image list

During a search: Displays all the images applicable to the criteria used for the search.

Other than during a search: Displays the image list of the album on the screen.

Refer to “Searching for an image (Filtering)” (page 39).

① Press $\leftarrow/\rightarrow/\downarrow/\uparrow$ to select the image you want to export and then press \oplus . A check mark will be attached to the check box of each selected image.

Repeat this operation to export multiple images at the same time.

To cancel the selection, select images to cancel and then press \oplus to delete the check mark in the check box.

② Press MENU.

The screen used for selecting the device to which to export is displayed.

6 Press \downarrow/\uparrow to select the device to which to export the image and then press \oplus .



7 Press \downarrow/\uparrow to select the folder you want to save to and press \oplus .

The confirmation screen used to decide whether to export or not is displayed.



Tip

A new folder is created automatically when you select [New folder].

8 Press \downarrow/\uparrow to select [Yes] and then press \oplus .

The exporting is finished.

9 Press \oplus when the confirmation screen is displayed.

The image is copied to the specified device.

Note

Do not turn off the power, remove the memory card, or disconnect the external device during exporting. Doing so may damage the photo frame or memory card, or damage the data.

Tips

- You can also use the MENU button on the photo frame.
- You can enlarge or reduce the image to export when you select the index image display.
- Any device that is not recognized by the photo frame is displayed in gray and you cannot select it.

Deleting an image

- 1** Press MENU when an image is displayed on the screen.
The menu is displayed.
- 2** Press \leftarrow/\rightarrow to select the  (Editing) tab.
The screen used for editing is displayed.
- 3** Press \downarrow/\uparrow to select [Delete] and then press \oplus .
- 4** Press \downarrow/\uparrow to select [Delete this image], [Selected images] or [Delete all images] and then press \oplus .
If you select [Delete this image], the image currently displayed is deleted. Go to step 6. (This item cannot be selected on the slideshow display.)
If you select [Selected images], you can select the image you want to delete from the image list. Go to step 5.
If you select [Delete all images], the image list is displayed. A check mark is attached to the check box of all the images. Go to step 6.

5 Specify the image to delete from the image list.

About the image list

During a search: Displays all the images applicable to the criteria used for the search.

Other than during a search: Displays all images in the device displayed on the screen.

Refer to “Searching for an image (Filtering)” (page 39).

① Press $\leftarrow/\rightarrow/\downarrow/\uparrow$ to select the image to delete and then press \oplus . A check mark will be attached to the check box of each selected image.

Repeat this operation to delete multiple images at the same time.

To cancel the selection, select images to cancel and then press \oplus to delete the check mark in the check box.

② Press MENU.

The delete confirmation screen is displayed.

6 Press \downarrow/\uparrow to select [Yes] and then press \oplus .
The image is deleted.

7 Press \oplus when the confirmation screen is displayed.

To format the internal memory

1 Press MENU.

The menu is displayed.

2 Press \leftarrow/\rightarrow to select the  (Settings) tab.
The settings screen is displayed.

3 Press \downarrow/\uparrow to select [Initialize] and then press \oplus .

4 Press \downarrow/\uparrow to select [Format internal memory] and then press \oplus .
The confirmation screen used for initializing the internal memory is displayed.

5 Press \downarrow/\uparrow to select [Yes], then press \oplus .

Notes

- When the message [Cannot delete a protected image.] appears on the screen, the image file was set to Read Only on a computer. In this case, connect the photo frame to a computer, and delete this file using the computer.
- The total capacity of the internal memory is not equal to the remaining capacity, even immediately after initialization.
- If deletion has started, the deleted image cannot be recovered even if you stop deletion. Delete images only after confirming you actually want to delete them.

Tips

- You can also use the MENU button on the photo frame.
- You can enlarge or reduce the image when you select the index image display.

Registering a mark

You can produce a slideshow only with images which have been selected beforehand and have been marked. You can easily check for images with marks using the index image display or single view mode.

- 1** Press MENU when an image is displayed on the screen.
The menu is displayed.
- 2** Press \leftarrow/\rightarrow to select the  (Editing) tab.
The screen used for editing is displayed.
- 3** Press \downarrow/\uparrow to select [Marking] and then press \oplus .
- 4** Press \downarrow/\uparrow to select the mark you want and then press \oplus .

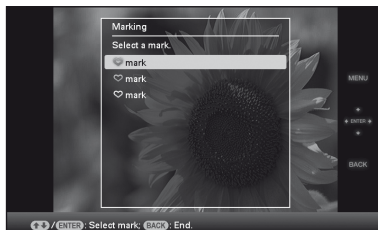

- 5** Press \downarrow/\uparrow to select [Mark this image], [Selected images] or [Mark all images] and then press \oplus .
If you select [Mark this image], the image currently displayed will be marked and showed in the future. Go to step 7. (This item cannot be selected on the slideshow display.)
If you select [Selected images], you can select the image to which you want to attach a mark from the image list. Go to step 6.
If you select [Mark all images], the image list is displayed. A check mark is attached

to the check box of all the images. Go to step 7.

6 Specify the image to which you want to attach a mark from the image list.

About the image list

During a search: Displays all the images applicable to the criteria used for the search.

Other than during a search: Displays all images in the device.

Refer to “Searching for an image (Filtering)” (page 39).

① Press $\leftarrow/\rightarrow/\downarrow/\uparrow$ to select the image to which to attach and then press \oplus . A check mark will be attached to the image. Repeat this operation to attach a mark to multiple images at the same time.

To cancel the selection, select an image you want to cancel and then press \oplus to remove the check mark from the check box.

② A mark will be attached to the image for which a check mark has been placed in the check box.

If a check mark is removed from the check box of an image, the mark will be removed from the image.

7 Press \downarrow/\uparrow to select [Yes] and then press \oplus .

The mark is attached to the selected image.

To delete the registration of a mark

Select [Unmark this image] or [Unmark all images] and then press \oplus in step 5. You can also cancel the selection when you remove the check mark from the check box.

[Unmark this image]: Removes a mark from the image currently displayed. (This item cannot be selected on the slideshow display.)

[Unmark all images]

During a search: Removes a marks from all the images applicable to the criteria specified in the search.

Other than during a search: Removes all marks from all images stored on the device displayed.

Note

A mark is saved only when it is registered with an image in the internal memory. A mark registered with an image on a memory card or an external device is removed when the power is turned off, or if you change the device being displayed.

Tips

- You can select a mark from among 3 types.
- You can also use the MENU button on the photo frame.
- You can enlarge or reduce the image when you select the index image display.



Searching for an image (Filtering)

You can search for an image which is stored in internal memory or on a memory card. You can filter an image using various criteria, such as the date, the folder in which the image is saved, the orientation of the image or mark, etc.

- 1 Press MENU when an image is displayed on the screen.
The menu is displayed.
- 2 Press ←/→ to select the  (Editing) tab.
The screen used for editing is displayed.

Note

You cannot select the  (Editing) tab when the clock and calendar are displayed.

- 3 Press ↓/↑ to select [Search] and then press .
- 4 Press ↓/↑ to select the criteria you want and then press .



- [Search by date]: Filters by the date.
- [Search by folder]: Filters by the folder.
- [Search by vertical/horizontal]: Filters by the image orientation.
- [Search by mark]: Filters by the mark.

- 5 Press ↓/↑ to select the item you want and then press .

To cancel the search for an image

Press the MENU button when an image is displayed on the screen and then select [Exit search (show all photo)].

To change the criteria for a search

Press the BACK button when an image you searched for is displayed on the screen.

Notes

- Do not turn off the power, remove the memory card, or disconnect the external device during a searching. Doing so may damage the photo frame or memory card, or damage the data.
- The search is cancelled automatically in the following cases.
 - When you change the playback device
 - When you search for an image which is stored on a memory card or external device and then remove that memory card or external device

Tip

You can also use the MENU button on the photo frame.

Specifying the playback device

You can specify the memory card or external device to be displayed.

- 1 Press MENU.
The menu is displayed.
- 2 Press \leftarrow/\rightarrow to select the \square (Select device) tab.
The screen used for selecting a device is displayed.

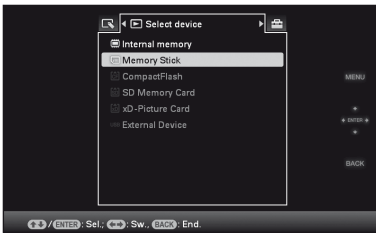

Tip

Insert the device at this point during the procedure if the device you want to use cannot be selected.

- 3 Press \downarrow/\uparrow to select the device you want to display and then press \oplus .
The images of the selected device are displayed.

Tips

- You can also use the MENU button on the photo frame.
- The search is cancelled automatically when you change the playback device during a search.

Adjusting the image size and position

Enlarging/reducing an image

You can enlarge or reduce an image in single view mode.

- 1 To enlarge an image, press \oplus (zoom in) on the remote control. To reduce an enlarged image, press \ominus (zoom out).
Each press of the \oplus button enlarges the image further. You can enlarge an image to a maximum of 5 times the original scale. You can move an enlarged image up, down, left, and right.

About crop and save

- The screen currently displayed is saved as it was trimmed after you press $\leftarrow/\rightarrow/\downarrow/\uparrow$ to move the enlarged image and then press the MENU button.
- You can select [Save as new image] or [Overwrite] by pressing the MENU button when the image is enlarged or reduced. Press \downarrow/\uparrow to select the method used to save the image.
- If you select [Save as new image], the image is saved as a new image.
- If you select [Overwrite], the image is overwritten. A confirmation screen is displayed when you select [Overwrite]. Press \downarrow/\uparrow to select [Yes] and then press \oplus to save the image. Press \oplus again when the confirmation screen is displayed after saving is finished.

Notes



- Enlarging an image may reduce the quality depending on the image size.
- It is not possible to enlarge an image using the buttons on the photo frame.

Rotating an image





Press ROTATE (⌂) on the remote control.

Each press of the button rotates the image 90 degrees counter-clockwise.

Operate from the menu of the photo frame

- 1** Press MENU in single display mode.
The menu is displayed.
- 2** Press ⬅️/➡️ to select the  (Editing) tab.
The screen used for editing is displayed.
- 3** Press ⬇️/⬆️ to select [Rotate] and then press .
The Rotate menu is displayed.



- 4** Press ⬇️/⬆️ to select the direction to rotate and then press .
 - :
Rotates the image 90 degrees clockwise.
 - :
Rotates the image 90 degrees counter-clockwise.
- 5** Press ⬇️/⬆️ to select [OK] and then press .

Note

An enlarged image cannot be rotated.

Tips

- For an internal memory image, image rotation data will be retained even after the power is turned off.
- You can rotate the image of the index image display.

Changing the settings of the auto power on/off function

The timer function to turn the photo frame on/off automatically can be set. Main power needs to be switched ON for this function.

- 1 Press MENU.
The menu is displayed.
- 2 Press \leftarrow/\rightarrow to select the  (Settings) tab.
The settings screen is displayed.
- 3 Press \downarrow/\uparrow to select [Auto power ON/OFF] and press \odot .
The screen used for setting a value for [Auto power ON/OFF] is displayed.

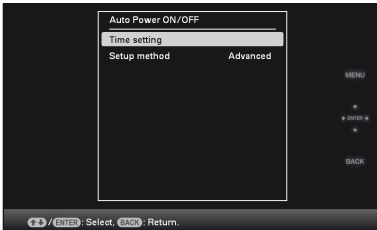

- 4 Press \downarrow/\uparrow to select [Setup method], and press \odot . Then press \downarrow/\uparrow to select [Simple] or [Advanced], and press \odot .
[Simple]: Sets the auto power ON/OFF function finely in one minute increments.
[Advanced]: Sets the auto power ON/OFF function according to a day of the week by one hour units.

- 5 Set the time setting.
[Simple]

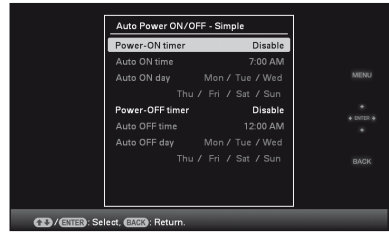

- ① Press \downarrow/\uparrow to select [Auto power ON/OFF] and then press \odot .
- ② Press \downarrow/\uparrow to select [Enable] and then press \odot .
- ③ Set the auto on/off timer.
Press \downarrow/\uparrow to set the time you want. AM or PM is displayed on the right of the screen when you select [12 hours] on the time display setting.
- ④ Set the auto ON/OFF day.
Press \downarrow/\uparrow to select the day you want to use this function and then press \odot to check. Press \downarrow/\uparrow to select [OK] and then press \odot .

[Advanced]



- ① Press $\leftarrow/\rightarrow/\downarrow/\uparrow$ to select the time you want to use the auto power on/off function.
You can set this function according to a day of the week by one hour units. The color of the selected time zone changes to blue after you press \odot . The power supply of the photo frame will be turned on when the blue time zone time occurs. The color of the selected time

zone changes to gray, after you select the blue time zone and then press \oplus . The power supply of the photo frame is turned off while it is in the gray time zone.

Tip

The power is turned off automatically at the time you set for [Auto power OFF] when you are using the photo frame.

The power is turned on automatically at the time you set for [Auto power ON] during the standby mode.

② Press $\leftarrow/\rightarrow/\downarrow/\uparrow$ to select [OK].

Using the alarm function

You can use the photo frame as an alarm clock.

Setting the alarm

Set to the alarm switch on the rear panel to ON.

Under condition of main power switch set to “On”, the alarm sound and alarm mode screen will appear at the scheduled alarm time.

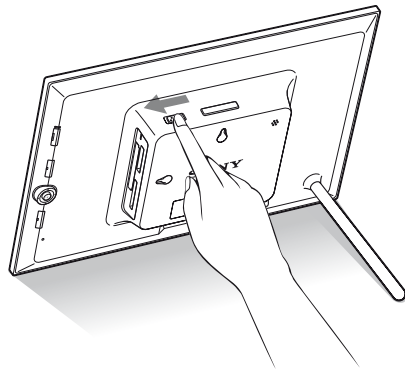

To turn off the alarm

Set the alarm switch on the rear panel to OFF.

The alarm is stopped although an alarm screen continues to be displayed.

The normal screen is displayed after you press any button on the photo frame other than ⏻ (on/standby).

Setting the time to be alarmed

- 1 Press MENU.
The menu is displayed.
- 2 Press \leftarrow/\rightarrow to select the  (Settings) tab.
The settings screen is displayed.
- 3 Press \downarrow/\uparrow to select [Alarm Setting] and press \oplus .

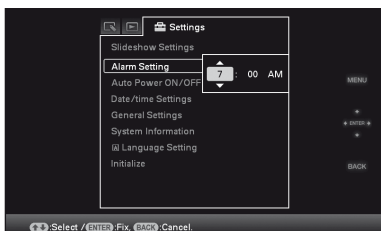

- 4 Press \downarrow/\uparrow to set the time you want.

Tips

- To set the clock, refer to “Setting the current time” (page 20).
- Auto power on/off will not function during alarm is set off.
- When alarm sets off at scheduled time, power will also turn on regardless of auto off settings. Main power needs to be set at ON for alarm to operate.

Changing the settings

You can change the following settings.

- Slideshow Settings
- Alarm Setting
- Auto power ON/OFF
- Date/time settings
- General Settings (Listing Order, Sony logo ON/OFF etc.,)
- Language setting
- Initialize

Setting procedure

- 1 Press MENU.
The menu is displayed.
- 2 Press \leftarrow/\rightarrow to select the  (Settings) tab.
The settings screen is displayed.



- 3** Press \downarrow/\uparrow to select the item you want to change and then press \odot . The setting screen of the selected item is displayed.

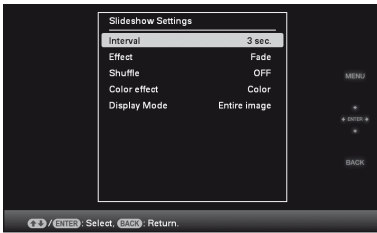

For example, when [Slideshow Settings] is selected.

- 4** Press \downarrow/\uparrow to select the item you want to change and then press \odot . This enables you to set each of the items (page 46).

Note

When the photo frame is, for instance, displaying a slideshow, some settings of some items cannot be changed. They are displayed in gray and cannot be selected.

- 5** Press \downarrow/\uparrow to select a setting value and then press \odot . Each time you press \downarrow/\uparrow (\downarrow/\uparrow from the photo frame), the setting value changes. In the case of a numerical value, press \uparrow to increase the value and press \downarrow to decrease the value.

If you press \odot , the setting is confirmed.

- 6** Press MENU.
The menu closes.

To reset to factory default settings

- Press MENU and then select ⚙ (Settings) - [Initialize] by pressing $\leftarrow/\rightarrow/\downarrow/\uparrow$.
- Press \downarrow/\uparrow to select [Reset] and then press \odot .
All adjusted values, except for the clock settings, are reset to the default settings.

Tip

You can also use the MENU button on the photo frame.

Items to set

*: Factory default settings

Item	Setting	Description	
Slideshow Settings	Refer to “Enjoying a slideshow” (page 29).		
Alarm Setting	Sets the specific time for an alarm. (➡ page 43)		
Auto power ON/OFF	Sets the timer function which turns the power supply of the photo frame on or off, automatically. You can use this function with the following settings. (➡ page 42)		
	Simple	Power-ON timer	You can set the timer (time/day) and input time for the power to turn on automatically, when you set this function to enable.
		Power-OFF timer	You can set the timer (time/day) and input time for the power to turn off automatically, when you set this function to enable.
	Advanced	OK	Returns to the previous screen after confirming the operation.
		Cancel	Returns to the previous screen after cancelling the operation.
		Reset all	Deletes all the selected times.
	Setup method	Advanced*	Sets the auto power ON/OFF function according to a day of the week by one hour units.
Simple		Sets the auto power ON/OFF function finely in one minute increments.	
Date/time settings	Sets the date, time, first day of a week, etc. (➡ page 20)		
General Settings	Listing Order	Sets the display order of images. This setting affects the order in [Slideshow Settings].	
		Number Order*	Displays images in order of file name.
		Shoot. Date	Displays images in order of shooting date.
	Auto display orientation	ON*/OFF: You can set the photo frame to automatically detect and rotate the orientation of images.	
	LCD backlight	Allows you to set the brightness of the backlight of the LCD screen to a level from 1 to 10*.	
	Beep	ON*/OFF: Sets the beep sound on/off.	
	Image file size	Album*	Compresses images and saves them in the internal memory, that you can save more images. Be aware that deterioration in image quality compared to the original images is noticeable when the images are displayed on a large monitor via a computer.
		Original	Saves images to the internal memory without compressing them. There is no deterioration, but you can save fewer images.
	Sony logo ON/OFF	ON*/OFF: You can set whether the photo frame's Sony logo lights or not.	

*: Factory default settings

Item	Setting	Description	
System Information	Version	Displays the version of the firmware of the photo frame.	
	Internal memory	Memory capacity	Indicates the maximum amount of space available in internal memory in the initial state.
		Remaining capacity	Indicates the amount of free space currently available in internal memory.
	Bluetooth Address	Displays when the Bluetooth adapter is connected to the photo frame.	
Language setting	Sets the display language on the LCD screen. Japanese, English*, French, Spanish, German, Italian, Russian, Korean, Simplified Chinese, Traditional Chinese, Dutch, Portuguese, Arabic, Persian, Hungarian, Polish, Czech, Thai, Greek, Turkish, Malay, Swedish, Norwegian, Danish, Finnish Note Default language setting may vary in some regions.		
Initialize	Format internal memory	You can format the internal memory. Notes <ul style="list-style-type: none"> • All the images added to the internal memory will be deleted. • Do not format the internal memory by using a connection to a PC or other external device. 	
	Reset	Returns all settings to their factory defaults except for the current date and time setting of the [Date/time settings].	

Displaying images on a USB memory

You can connect a mass-storage-complaint USB memory device to the photo frame and display an image directly from the USB memory.

Notes

- We cannot guarantee connection with all types of mass storage devices.
- The playback device will be switched to the USB memory if you connect the USB memory to the USB A/Bluetooth jack during playback the internal memory.

- 1** Connect the photo frame to the AC power source. (➡page 18)
- 2** Turn the photo frame to ON. (➡page 19)
- 3** Connect the USB memory to the USB A/Bluetooth connector.

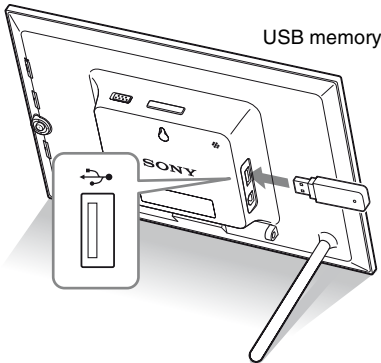

- 4** Select the playback device. (➡page 40)
An image on the USB memory is displayed on the screen.

For details on the slideshow, refer to page 29. For details on adding images to the internal memory, refer to page 32.

Notes

- When using a commercially available USB cable, use an A-Type USB cable that is less than 3 meters long.
- Do not disconnect the USB memory or turn the photo frame off while the access lamp on the USB memory is flashing. Doing so may damage the data stored on the USB memory. Sony assumes no responsibility for any damage or loss of data.
- A USB hub or USB device with a built-in USB hub may not work properly.
- The photo frame cannot use data that has been encrypted or compressed using, for instance, fingerprint authentication or a password.

Transferring images using Bluetooth

You can connect a Bluetooth adaptor (optional) to the USB A/Bluetooth connector of the photo frame and transfer images from a Bluetooth compatible mobile phone or other device. The transferred images are saved in internal memory.

Note

You cannot send a file to other Bluetooth compatible devices from the photo frame.

Compatible profiles for Bluetooth communication

The DPF-D82/D92 supports the following profiles:

- BIP (Basic Imaging Profile)
Image Push Responder
- OPP (Object Push Profile)
Object Push Server

For the profiles that your Bluetooth device supports, please refer to its manual.

What is a “Profile”?

A profile consists of the standards that enable Bluetooth wireless communication. There are several profiles available, depending on the purposes and product to be used. To make Bluetooth communication possible, the devices used in the communicated should support the same profile.

Compatible image file formats that can be displayed

See page 64.

Maximum number of pixels that can be handled

See page 64.

- 1 Connect the photo frame to the AC power source. (→ page 18)
- 2 Turn the photo frame to ON. (→ page 19)
- 3 Connect the Bluetooth adaptor (optional) to the USB A/Bluetooth connector.
 is displayed on the upper portion of the screen when the guide is displayed.

Note

If any device, other than the Bluetooth adaptor, such as a memory card, camera, PC, or other USB memory device or a USB cable is connected to any of the memory card slots, or the USB A/Bluetooth connector, disconnect it from the photo frame and then connect the Bluetooth adaptor.

- 4 Check the Bluetooth address of the photo frame.
You can display the address from [System Information]. (page 46)

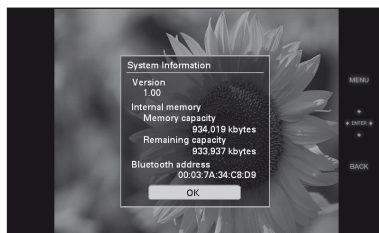

Tip

The address is displayed only when the Bluetooth adaptor is connected.

- 5 Transfer an image from the Bluetooth-compliant mobile phone, or other device to the photo frame. The image transferred is saved on the internal memory.

Note

You cannot transfer an image to the memory card of a digital photo frame.

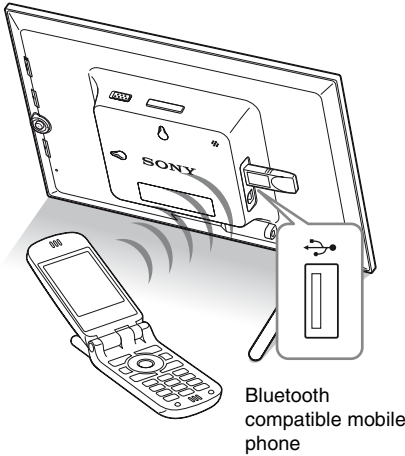

To select the photo frame from a Bluetooth-compliant device, select “Sony DPF-D92 ##,” “Sony DPF-D82 ##.” (“##” stands for the two figures from the right of the address displayed in [System Information].)

When input of Passkey* is required

Input “0000.” You cannot change the Passkey with the photo frame.

* A Passkey is often referred to as a “pass code” or “PIN code.”

Notes

- We cannot guarantee that this product works with all devices enabled with Bluetooth wireless technology.
- Do not use the DPPA-BT1 outside the area you purchased it. Depending on the area, the use of this product may violate the local radio wave regulations and may be subject to penalty.
- The communication distance of the product may vary depending on the obstacles between the product (a human body, metal objects, or a wall) and the mobile phone or other device.
- The sensitivity of the Bluetooth communication may be affected under the following conditions:
 - When there is an obstacle between the product and the mobile phone or other product such as a human body, metal objects, or a wall.

- Where a wireless LAN is established or a microwave oven is being used near-by, or other electromagnetic waves are emitted.

- We cannot guarantee that this product works with all devices enabled with Bluetooth wireless technology.
 - Sony cannot assume any responsibility for any information leakage that may be caused by the use of Bluetooth communications.
 - Sony cannot accept responsibilities for any failure to satisfy the protection requirements resulting from a non-recommended modification or use of the product.
- For customer support information, please refer to the operating instructions of the photo frame.

Caution

- Radio waves from a Bluetooth device may adversely affect the operation of electrical and medical devices, and could lead to accidents due to malfunctions. Make sure to turn off the product and mobile phone and do not use this product in the following places:
 - Inside hospitals, trains, airplanes, gas stations or other places where flammable gas may be present.
 - near automatic doors or fire alarms or other automatically controlled devices.
 - near medical equipment.
- Keep this product at least 22 cm away from cardiac pacemakers. Radio waves from this product may adversely affect the operation of cardiac pacemakers.

Connecting to a computer

You can connect to a computer to view and copy images from the internal memory of the photo frame to the computer, and copy images from the computer to the photo frame.

System requirements

To connect a computer to the picture frame, your computer must satisfy the following recommended system requirements.

■ Windows

Recommended OS: Microsoft Windows Vista SP1/Windows XP SP3/Windows 2000 Professional SP4

Port: USB port

■ Macintosh

Recommended OS: Mac OS X (10.4 or later)

Port: USB port

Notes

- If multiple USB devices are connected to a computer or if a hub is used, a problem may occur. In such a case, simplify the connections.
- You cannot operate the photo frame from another USB device being used simultaneously.
- Do not disconnect the USB cable during data communication.
- Operation with all computers that satisfy the recommended system requirements is not guaranteed.
- The photo frame has been demonstrated as operable when connected to PC or Sony digital photo printer. When other devices are connected to the photo frame, these devices may not recognize the internal memory of the photo frame.

Connecting to a computer to exchange images

Note

This section shows an example for a connection for Windows Vista. Depending on the OS you use, the screen display and procedures may vary.

- 1 Connect the photo frame to the AC power source. (→ page 18)
- 2 Connect the computer and photo frame with a commercially available USB cable.

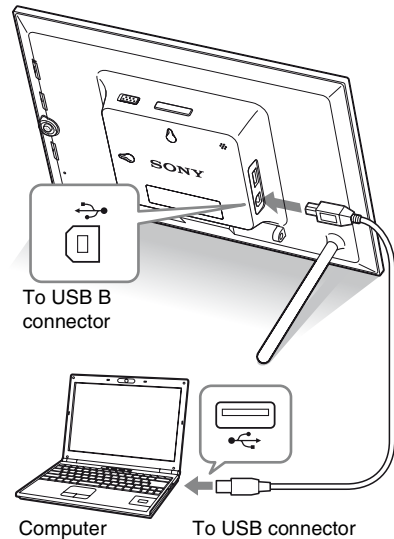

Note

Use a B-Type USB cable that is less than 3 meters long.

- 3 Turn the photo frame to ON. (→ page 19)

4 When the [AutoPlay] window appears on the computer display, click [Open folder to view files]. If the [AutoPlay] window does not appear, click [Computer (My Computer)] in the Start menu, and then open the removable disc.

5 Move the cursor in this window and right click, and then click [New] - [Folder]. Name this new folder. In this manual, the folder name “sony” is used as an example.

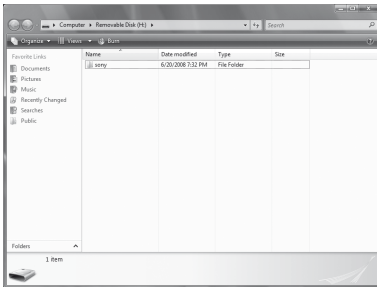

6 Double click to open this “sony” folder.

7 Open the folder that contains the image files you want to copy, and then copy the image files by using drag-and-drop.

Notes



- When saving images from a computer in the internal memory, make a folder in the internal memory and save the images in this folder. If you do not make a folder, you can only save up to 512 images. In addition, the number of images may be reduced depending on the file name length or character type.
- A particular image may not be displayed in order of the shooting date on the index image display, etc as the information on the shooting date may have been changed or lost when you edited or saved that image file on a computer.
- When images from the computer are saved in the internal memory of the photo frame, the image files are saved without being compressed. As a result,

fewer images may be able to be saved to the internal memory of the photo frame.

- Image files made or edited on a computer may not be displayed. Image files set to “Read Only” on a computer cannot be deleted on the photo frame. Cancel “Read Only” before saving image files from a computer on the photo frame.

Disconnecting your computer

Disconnect the USB cable or turn the photo frame to OFF after disconnecting it from your computer.

- 1** Double-click  on the Task Tray.
- 2** Click  (USB Mass Storage Device) → [Stop].
- 3** Click [OK] after checking the drive you want to remove.

If an error message appears

If an error occurs, one of the following error messages may be displayed on the LCD screen of the photo frame. Follow the corresponding solution below to solve the problem.

Error message	Meaning/Solutions
No Memory Stick. / No CompactFlash card. / No SD Memory Card. / No xD-Picture Card. / No External Device.	<ul style="list-style-type: none">• A memory card is not inserted in a slot. Or, an external device is not connected to the USB A/Bluetooth connector. Insert a memory card in the corresponding slot. Or, connect an external device. (➡ pages 21, 48)
An incompatible Memory Stick is inserted. / An incompatible CompactFlash card is inserted. / An incompatible SD Memory Card is inserted. / An incompatible xD-Picture Card is inserted. / An incompatible External Device is inserted.	<ul style="list-style-type: none">• An unsupported memory card is inserted. Or, an unsupported external device is connected to the USB A/Bluetooth connector. Use a memory card or external device that is supported by the photo frame.
No images on file.	<ul style="list-style-type: none">• There is no image file that can be displayed on the screen of the photo frame on the memory card or the external device. Use a memory card or on external device containing image files that can be displayed with the photo frame.
Cannot delete a protected image.	<ul style="list-style-type: none">• To delete a protected file, cancel the protection on your digital camera or computer.
Media is protected. Remove protection then try again.	<ul style="list-style-type: none">• The memory card is write-protected. Slide the write-protect switch to the enable position. (➡ page 62)
The Memory Stick is full. / The CompactFlash card is full. / The SD Memory Card is full. / The xD-Picture Card is full. / The External Device is full.	<ul style="list-style-type: none">• No more data can be saved because the memory card, the internal memory, or the external device is full. Delete images, or use a memory card or external device with free space available.

Error message	Meaning/Solutions
Error reading the Memory Stick. / Error reading the CompactFlash card. / Error reading the SD Memory Card. / Error reading the xD-Picture Card. / Error reading the internal memory./ Error reading the External Device.	<ul style="list-style-type: none"> • An error has occurred. If this error message is displayed frequently, check the status of the memory card or external device with a device other than the photo frame. • In the case of an external device: The external device may be write-protected. Cancel the write-protection setting for the device you are using. The internal memory of a digital camera may be write-protected.
Write error in the Memory Stick. / Write error in the CompactFlash card. / Write error in the SD Memory Card. / Write error in the xD-Picture Card. / Write error in the internal memory./ Write error in the External Device.	<ul style="list-style-type: none"> • For an internal memory: Initialize the internal memory. <p>Note</p> <p>When you initialize the internal memory, please note that all the image files added to the album are deleted.</p>
The Memory Stick is read only.	<ul style="list-style-type: none"> • A “Memory Stick-ROM” is inserted. To save the images, use the “Memory Stick” recommended.
The Memory Stick is protected.	<ul style="list-style-type: none"> • A protected “Memory Stick” is inserted. To edit and save the images, use an external device to remove protection.
Media format not supported.	<ul style="list-style-type: none"> • For a memory card, use your digital camera or other device to format the memory card. • For the internal memory, initialize it with the photo frame. <p>Note</p> <p>When you initialize the media, all the files on the media will be deleted.</p>
Cannot open the image.	<ul style="list-style-type: none"> • The photo frame cannot display or open an image file whose format is not supported.
No more USB hubs can be connected.	<ul style="list-style-type: none"> • Connect the device directly to the photo frame, or use a device without a built-in USB hub.
Incompatible USB device. Check device’s USB settings.	<ul style="list-style-type: none"> • Connect a device with support for mass storage. If the USB setting of your device is incorrect, set the mass storage mode in the USB setting.

If trouble occurs

Before submitting the photo frame for repair, try using the following guidance to solve the problem. If the problem persists, consult with your Sony dealer or Sony service facilities.



Power supply

Symptom	Check item	Cause/Solutions
The power cannot be turned on.	<ul style="list-style-type: none">• Is the AC power plug inserted correctly?	→ Insert the power plug properly.

Displaying images

If the power is turned on but images are not displayed or the settings of the operation screen cannot be configured, confirm the following check items.

Symptom	Check item	Cause/Solutions
No images are displayed on the screen.	<ul style="list-style-type: none">• Is a memory card inserted or an external device connected properly?	→ Insert a memory card or connect an external device properly. (→ pages 21, 49)
	<ul style="list-style-type: none">• Does the memory card contain images saved with a digital camera or other device?• Are images stored on the external device?	→ Insert a memory card containing images or connect an external device containing images. → Check the file formats that can be displayed. (→ page 64)
	<ul style="list-style-type: none">• Is the file format compatible with DCF?	→ A file that is not compatible with DCF may not be able to be displayed with the photo frame, even if it can be displayed with a computer.
Images are not played back in the order of shooting date.	<ul style="list-style-type: none">• Were these images saved from a computer?• Were these images edited on a computer?	→ The information on the shooting date may be changed or lost when you edit or save an image file on a computer.

Symptom	Check item	Cause/Solutions
Some images are not displayed.	<ul style="list-style-type: none"> • Are the images displayed in the index view? 	<ul style="list-style-type: none"> → If the image is displayed in the index view but cannot be displayed as single image, the image file may be damaged even though its thumbnail preview data is fine. → A file that is not compatible with DCF may not be able to be displayed with the photo frame, even if it can be displayed with a computer.
	<ul style="list-style-type: none"> • Does the mark displayed below appear in the index view? 	<ul style="list-style-type: none"> → If the mark shown on the left is displayed, the image file may not be supported by the photo frame because, for example, it is a JPEG file that was created with your computer. Also, the image file may be supported, but not contain thumbnail data. Select the mark and press (⊕) to change the screen to the single image display. If the mark on the left is displayed again, the image cannot be displayed because the image file is not supported by the photo frame.
	<ul style="list-style-type: none"> • Were the images created with an application on a computer? 	
	<ul style="list-style-type: none"> • Does the mark displayed below appear in the index view? 	<ul style="list-style-type: none"> → If the mark shown on the left is displayed, the image file is supported by the photo frame, but the thumbnail data or image itself cannot be opened. Select the mark and press (⊕). If the mark shown on the left is displayed again, the image cannot be displayed.
	<ul style="list-style-type: none"> • Are there more than 9,999 images in the memory card or external device? 	<ul style="list-style-type: none"> → The photo frame can play, save, delete, or otherwise handle up to 9,999 image files.
	<ul style="list-style-type: none"> • Did you rename the file with a computer or other device? 	<ul style="list-style-type: none"> → If you named or renamed the file on your computer and the file name includes characters other than alphanumeric characters, the image may not be able to be displayed on the photo frame.
	<ul style="list-style-type: none"> • Is there a folder with more than 8 levels in its hierarchy on the memory card or in the external device? 	<ul style="list-style-type: none"> → The photo frame cannot display images saved in a folder that is more than eight levels deep.

Symptom	Check item	Cause/Solutions
The file name is not displayed properly.	<ul style="list-style-type: none"> • Did you rename the file with a computer or other device? 	<p>→ If you named or renamed the file on your computer and the file name includes characters other than alphanumeric characters, the file name may not be able to be displayed properly on the photo frame. Also, for a file created on a computer or other device, a maximum of ten characters from the beginning of the file name can be displayed.</p> <p>Note Only alphanumeric characters can be displayed.</p>
Blank areas appear at the top and bottom.	<ul style="list-style-type: none"> • Is the image extremely tall or wide? 	<p>→ If an image is extremely tall or wide, blank areas may appear because of the ratio between the height and width.</p>

Saving and deleting images

Symptom	Check item	Cause/Solutions
Cannot save an image.	<ul style="list-style-type: none"> • Is the memory card write-protected? 	<p>→ Cancel write-protection and try saving again.</p>
	<ul style="list-style-type: none"> • Is the write-protect switch of the memory card in the [LOCK] position? 	<p>→ Slide the write-protect switch to the enable position.</p>
	<ul style="list-style-type: none"> • Is the memory card full? 	<p>→ Replace the memory card with one with sufficient free space. Or, delete any unwanted images. (→ page 36)</p>
	<ul style="list-style-type: none"> • Is the internal memory full? 	<p>→ Delete any unwanted images. (→ page 36)</p>
	<ul style="list-style-type: none"> • Did you save images from a computer to the internal memory without making a folder in the internal memory? 	<p>→ If you do not make a folder, you can only save up to 512 images. In addition, the number of images may be reduced depending on the file name length or character type. When you save images in the internal memory from a computer, be sure to make a folder in the internal memory and save the images in this folder.</p>

Symptom	Check item	Cause/Solutions
Cannot delete an image.	• Is the memory card write-protected?	→ Use the device you are using to cancel write-protection and try deleting again.
	• Is the write-protect switch of the memory card in the [LOCK] position?	→ Slide the write-protect switch to the enable position.
	• Are you using a “Memory Stick-ROM”?	→ It is not possible to delete an image from or format a “Memory Stick-ROM”.
	• Is this image protected?	→ Check the image information from the single view mode. (→ page 28) → An image with a  mark is set to Read Only. You cannot delete it on the photo frame.
An image was deleted accidentally.	—	→ An image cannot be recovered once it is deleted.

Connecting a external device

Symptom	Check item	Cause/Solutions
Nothing happens even if the USB cable is disconnected and then re-connected.	—	→ An over current error may have occurred with the photo frame. To recover from the error, turn the power of the photo frame off and then back on.

Photo frame

Symptom	Check item	Cause/Solutions
Nothing happens even if you operate the photo frame.	—	→ Push the reset switch on the back of the photo frame using a long, thin object such as a pin, etc. (→ page 12) → Set the power switch to off, and then set it to on again. (→ page 12)

Remote control

Symptom	Check item	Cause/Solutions
Nothing happens even if you operate the remote control.	<ul style="list-style-type: none"> Is the battery inserted in the remote control properly? 	<ul style="list-style-type: none"> → Replace the battery. (→ page 15) → Insert a battery. (→ page 15) → Insert a battery in the proper orientation. (→ page 15)
	—	<ul style="list-style-type: none"> → Point the top end of the remote control towards the remote sensor on the photo frame. (→ page 15) → Remove any obstruction between the remote control and the remote sensor.
	<ul style="list-style-type: none"> Is there a protective sheet inserted? 	<ul style="list-style-type: none"> → Remove the protective sheet. (→ page 15)

Precautions

Safety

- Be careful not to set or drop any heavy objects on the power cord, or to damage the power cord in any way. Never operate this photo frame with a damaged power cord.
- Should any solid object or liquid fall into the cabinet, unplug the photo frame and have it checked by qualified personnel before operating it any further.
- Never disassemble the photo frame.
- To disconnect the power cord, pull it out by the plug. Never pull the power cord itself.
- When the photo frame is not going to be used for an extended period of time, disconnect the power cord from the wall outlet.
- Do not handle the photo frame roughly.
- To reduce the risk of electrical shock, always unplug the photo frame from the electrical outlet before cleaning and servicing the photo frame.

Installation

- Avoid placing the photo frame in a location subject to:
 - vibration
 - humidity
 - excessive dust
 - direct sunlight
 - extremely high or low temperatures
- Do not use electrical equipment near the photo frame. The photo frame will not work properly in electromagnetic fields.
- Do not place heavy objects on the photo frame.

On the AC adaptor

- Even if your photo frame is turned off, AC power (house current) is still supplied to it

while it is connected to the wall outlet via the AC adaptor.

- Be sure to use the AC adaptor supplied with the photo frame. Do not use other AC adaptors, as this may cause a malfunction.
- Do not use the supplied AC adaptor for other devices.
- Do not use an electrical transformer (travel converter), as this may cause overheating or a malfunction.
- In case the cord of the AC adaptor is damaged, do not use it any longer, as this may be dangerous.

On moisture condensation

If the photo frame is brought directly from a cold location to a warm location or placed in an extremely warm or humid room, moisture may condense inside the unit. In such cases the photo frame will probably not work properly and may even develop a fault if you persist in using it. If moisture condensation occurs, unplug the AC adaptor of the photo frame and do not use the photo frame for at least one hour.

On transport

When you transport the photo frame, remove the memory card, external devices, AC adaptor, and connected cables from the photo frame and put the photo frame and its peripherals in the original box with the protective packaging.

If you no longer have the original box and packing parts, use similar packing material so that the photo frame will not be damaged while being transported.

Cleaning

Clean the photo frame with a soft dry cloth, or a soft cloth lightly moistened with a mild detergent solution. Do not use any type of solvent, such as alcohol or benzine, which may damage the finish.

Restrictions on duplication

TV programs, films, video tapes, portraits of other people, or other materials may be copyrighted. Unauthorized use of such materials may infringe the provisions of the copyright law.

Disposing of the photo frame

Even if you perform [Format internal memory], the data in the internal memory may not be erased completely. When you dispose of the photo frame, we recommend that you physically destroy the photo frame.

About memory cards

“Memory Stick”

Types of “Memory Stick” that the photo frame can use

With the photo frame, you can use the following types of “Memory Stick”^{*1}:

Type of “Memory Stick”	Displaying	Deleting/ Saving
“Memory Stick” ^{*2} (Not compatible with “MagicGate”)	OK	OK
“Memory Stick” ^{*2} (Compatible with “MagicGate”)	OK ^{*5}	OK ^{*5}
“MagicGate Memory Stick” ^{*2}	OK ^{*5}	OK ^{*5}
“Memory Stick PRO” ^{*2}	OK ^{*5}	OK ^{*5}
“Memory Stick PRO-HG” ^{*2}	OK ^{*5*6}	OK ^{*5*6}
“Memory Stick Micro” ^{*3} (“M2” ^{*4})	OK ^{*5}	OK ^{*5}

^{*1} The photo frame supports FAT32. The photo frame has been demonstrated as operable with a “Memory Stick” with a capacity of 16 GB or less manufactured by Sony Corporation. However, we do not guarantee the operations of all the “Memory Stick” media.

^{*2} The photo frame is equipped with a slot compatible with both standard-size and Duo-size media. Without a “Memory Stick Duo” adaptor, you can use both a standard-size “Memory Stick” and the compact-size “Memory Stick Duo”.

^{*3} When using a “Memory Stick Micro” with the photo frame, always insert it into an M2 adaptor.

^{*4} “M2” is an abbreviation for “Memory Stick Micro”. In this section, “M2” is used to describe a “Memory Stick Micro”.

^{*5} Data reading/recording that requires “MagicGate” copyright protection cannot be performed. “MagicGate” is the general name of a copyright

protection technology developed by Sony using authentication and encryption.

- ^{*6} The photo frame does not support 8 bit parallel data transfer.

Notes on use

- For the latest information on the “Memory Stick” types that the photo frame supports, see the “Memory Stick” compatibility information on the Sony web site:
<http://www.memorystick.com/en/support/support.html>
(Select the area where you use your photo frame, and then select “Digital Photo Frame” from each area page.)
- Do not insert more than one “Memory Stick” at the same time, or this may cause trouble with the photo frame.
- If you use a “Memory Stick Micro” with the photo frame, the “Memory Stick Micro” needs to be inserted into an “M2” adaptor.
- If you insert a “Memory Stick Micro” into the photo frame without an “M2” adaptor, you may be unable to remove the “Memory Stick Micro”.
- If you insert a “Memory Stick Micro” into an “M2” adaptor, and insert the “M2” adaptor into a “Memory Stick Duo” adaptor, the photo frame may not operate properly.
- When you initialize a “Memory Stick”, use the initialization function of your digital camera. If you initialize it with your computer, images may not be displayed properly.
- When you perform initialization, all the protected images are erased. To avoid erasing important data by accident, make sure to check the contents of the “Memory Stick” before initialization.
- You cannot record, edit, or delete data if you slide the write-protect switch to LOCK.
- Do not attach any other material than the supplied label on the labelling position. When you attach the supplied label, be sure to attach it to the labelling position. Be careful that the label does not stick out.

SD memory card

The SD memory card slot of the photo frame allows you to use the following:

- SD memory card^{*1}
- miniSD card, microSD card
(An adaptor is necessary.)^{*2}
- SDHC memory card^{*3}
- MMC standard memory card^{*4}

We do not guarantee proper operations for all types of SD memory cards and MMC standard memory cards.

- ^{*1} The photo frame has been demonstrated as operable with an SD memory card with a capacity of 2 GB or smaller.
- ^{*2} Some commercially available card adaptors have projected terminals on the back. This type of adaptor may not work properly with the photo frame.
- ^{*3} The photo frame has been demonstrated as operable with an SDHC memory card with a capacity of 32 GB or less.
- ^{*4} The photo frame has been demonstrated as operable with an MMC standard memory card with a capacity of 2 GB or less.

Notes on use

Data reading/recording that requires copyright protection cannot be performed.

xD-Picture Card

With the xD-Picture Card slot of the photo frame, you can use an xD-Picture Card^{*5}. Not all the memory card operations are supported and we do not guarantee proper operations for all types of xD-Picture Card.

- ^{*5} The photo frame has been demonstrated as operable with an xD-Picture Card with a capacity of 2 GB or less.

CompactFlash card

The CompactFlash card slot of the photo frame allows you to use the following:

- CompactFlash Memory Card (Type I/ Type II) and CF+Card (Type I/Type II)- compatible CompactFlash Card^{*6}
- Microdrive

You can also use the Smart Media card by using a commercially available CompactFlash card adaptor^{*7}.

However, we do not guarantee proper operations for all types of CompactFlash cards.

^{*6} Use a CompactFlash card with a power specification of 3.3V or 3.3V/5V. You cannot use a type for 3V or 5V only. Do not insert other types of CompactFlash card into the photo frame's insertion slot. The photo frame may be damaged. The photo frame has been demonstrated as operable with a CompactFlash with a capacity of 32 GB or smaller.

^{*7} When using a commercially available CompactFlash card adaptor, refer to the operating instructions of the adaptor you use for how to install the card and adaptor. When using a CompactFlash card adaptor, a write-protected card may not work properly.

- Do not disassemble or modify a card.
- Do not expose a card to water.
- Do not use or store a card under the following conditions:
 - Locations beyond the required operational conditions including locations such as the hot interior of a car parked in the sun and/ or in the summer, the outdoors exposed to direct sunlight, or a place near a heater.
 - Humid locations or locations with corrosive substances present
 - Locations subject to static electricity or electrical noise

Notes on using a memory card

- When using a card, make sure to check the correct insertion direction of the card and the correct insertion slot.
- When inserting the memory card, it will only insert part of the way, so do not try to force it, as this could damage the memory card and/or photo frame.
- Do not remove a card or turn off the photo frame while the photo frame is reading or writing data, or the access indicator is flashing. Otherwise, data may be rendered unreadable or be erased.
- We recommend that you save a backup of important data.
- Data processed with the computer may not be displayed with the photo frame.
- When you carry or store a card, put it in the case supplied with it.
- Do not touch the terminal of a card with your hand or a metal object.
- Do not strike, bend or drop a card.

Specifications

■ Photo frame

LCD screen

LCD panel:

DPF-D92: 9.0 inches, TFT active matrix

DPF-D82: 8.0 inches, TFT active matrix

Total number of dots:

DPF-D92/D82: 1,152,000

(800 × 3(RGB) × 480) dots

Display aspect ratio

15:9

Effective display area

DPF-D92: 8.6 inches

DPF-D82: 7.6 inches

LCD backlight life

DPF-D92/D82: 20,000 hours

(before brightness of the backlight is reduced to half)

Input/Output connectors

USB connector (TypeB, Hi-Speed USB)

USB A/Bluetooth connector (TypeA, Hi-Speed USB)

Slots

“Memory Stick PRO” slot

SD memory card/MMC/

xD-Picture Card slot

CompactFlash card/Microdrive slot

Compatible image file formats

JPEG: DCF 2.0 compatible, Exif 2.21 compatible, JFIF^{*1}

RAW (preview only^{*2}): SRF, SR2, ARW (2.0 or lower version)

(Some image file formats are not compatible.)

Maximum number of pixels that can be displayed

8,000 (H) × 6,000 (V) pixels

File system

FAT12/16/32,

sector size of 2,048 bytes or smaller

Image file name

DCF format, 256 characters within 8th hierarchy

Maximum number of files that can be handled

9,999 files for a memory card/an external device

Internal memory capacity^{*3}

DPF-D92/D82: 1 GB

(Approx. 2,000 images^{*4} can be saved.)

When measuring media capacity, 1 GB equals 1 billion bytes, a portion of which is used for data management.

Power requirements

DC IN jack, DC 12V

Power consumption

Model	in operation mode	including the AC adaptor
DPF-D92/ D82	at the maximum load	11.6W
	normal mode*	5.5W

* The definition of the normal mode is a status which allows the performance of a slideshow using images stored in the internal memory with the default settings without inserting a memory card or connecting an external device.

Operating temperature

5 °C to 35 °C (41 °F to 95 °F)

Dimensions

[With the stand spread out]

DPF-D92:

Approx. 276 × 189 × 144.1 mm

(10 ⁷/₈ × 7 ¹/₂ × 5 ³/₄ inches)

(width/height/depth)

DPF-D82:

Approx. 243 × 162 × 126.6 mm

(9 ⁵/₈ × 6 ¹/₂ × 5 inches)

[When the photo frame is hanging on the wall]

DPF-D92:

Approx. 276 × 189 × 39.5 mm

(10 ⁷/₈ × 7 ¹/₂ × 1 ⁹/₁₆ inches)

(width/height/depth)

DPF-D82:

Approx. 243 × 162 × 39.5 mm

(9 ⁵/₈ × 6 ¹/₂ × 1 ⁹/₁₆ inches)

Mass

DPF-D92: Approx. 810 g (1 lb 12 ⁵/₈ oz)

DPF-D82: Approx. 720 g (1 lb 9 ³/₈ oz)
(excluding the AC adaptor)

Included accessories

See “Checking included items” on
page 11.

■ AC adaptor

The following are common specifications of
DPF-D92/D82.

Power requirements

~ 100 V to 240 V, 50/60 Hz
0.48 A

Rated output voltage

== 12 V 1.2 A

Dimensions

Approx. 34 × 72 × 69 mm
(1 ³/₈ × 2 ⁷/₈ × 2 ³/₄ inches)
(width/height/depth)
(excluding the protruding parts)

Mass

Approx. 110 g (4 oz)

See the label of AC adaptor for more details.

Design and specifications are subject to change
without notice.

*1: Baseline JPEG with 4:4:4, 4:2:2, or 4:2:0 format

*2: RAW files are displayed as thumbnail preview.

*3: The capacity is calculated as 1 GB is equivalent to
1 000 000 000 bytes. The actual capacity is
reduced as files for management and applications
are included. Approximately 900 MB on DPF-
D92/D82 can be used for your actual operation.

*4: Approximate number is shown when the images
taken by 2 000 000 pixels equivalent camera are
saved. The value may vary depending on the
shooting condition.

Customer support home page

The latest support information is available at the
following home page address:

<http://www.sony.net/>

Index

A

AC adaptor 18
Accessories 11
Adding to the internal memory 32
Alarm 43, 46
Associated file 28
Auto power ON/OFF 46
Auto power on/off 42

B

Bluetooth 49

C

Calendar 21
Changing the settings 44
Cleaning 60
Connecting
 Computer 51
 External device 48
Connecting to the AC power source 18

D

Date/time settings 20, 46
DC IN 8.4 V 18
Deleting an image 36
Display priority 22

E

Error messages 53
Exporting an image 34

F

Features 9
Format internal memory 47

G

General Settings 46

I

Image file size 46
Index image display 27
Initialize 47

L

Language setting 47

M

Mass storage compatible devices 48
Memory cards 61
 “Memory Stick” 61
 CompactFlash card 62
 Notes on use 63
 SD memory card 62
 xD-Picture Card 62

P

Placing in portrait or landscape orientation 16
Playback device 40
Precautions 60

R

Remote control 15
Replacing the battery of the remote control 15
Reset 47
Rotating an image 41

S

Searching for an image 39
Setting the stand 16
Single view mode 26
Slideshow display 24
Slideshow Settings 31
 Color effect 31
 Display Mode 31
 Effect 31
 Interval 31
 Shuffle 31
Specifications 64

System Information 47

System requirements
 Macintosh 51
 Windows 51

T

Troubleshooting 55

U

USB cable 48

W

Write-protect switch 62

Z

Zooming an image in/out 40

Printed using VOC (Volatile Organic
Compound)-free vegetable oil based ink.

Sony Corporation Printed in China
