

**SAMSUNG**

# MICROWAVE OVEN

## Owner's Instructions and Cooking Guide

**CE2974N / CE2974NT**  
**CE2914N / CE2914NT**

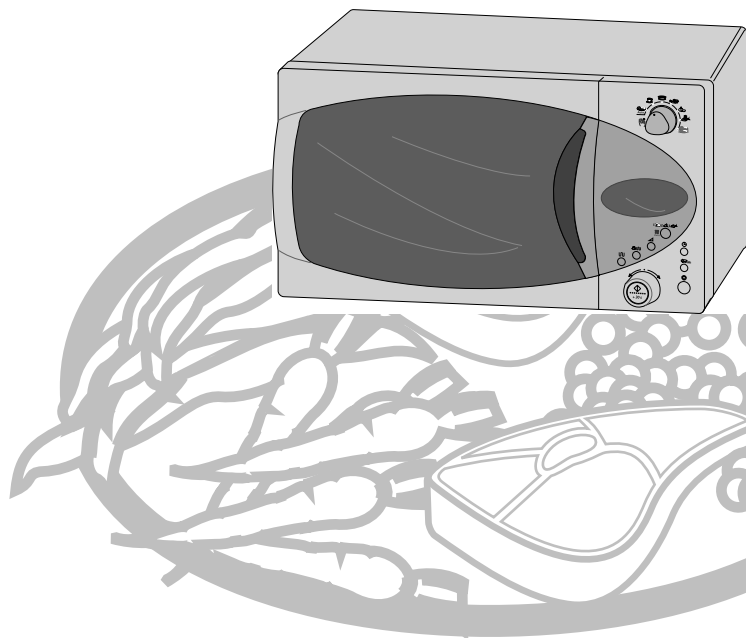

Quick Look-up Guide.....	2
Oven.....	3
Accessories.....	5
Using this Instruction Booklet.....	5
Safety Precautions.....	6
Installing Your Microwave Oven.....	7
Setting the Time (CE2974N/CE2974NT).....	8
How a Microwave Oven Work.....	8
Checking that Your Oven is Operating Correctly.....	9
What to Do if You are in Doubt or Have a Problem.....	9
Cooking / Reheating.....	10
Power Levels.....	11
Stopping the Cooking.....	11
Adjusting the Cooking Time.....	12
Using the Auto Reheat/Cook Feature (CE2974N/CE2974NT).....	12
Auto Reheat / Cook Settings(CE2974N/CE2974NT).....	13
Using the Instant Reheat/Cook Feature(CE2914N/CE2914NT).....	14
Instant Reheat/Cook Setting(CE2914N/CE2914NT).....	14
Using the Auto Defrost Feature (CE2974N/CE2974NT).....	14
Auto Defrost Settings(CE2974N/CE2974NT).....	15
Manual Defrosting Food(CE2914N/CE2914NT).....	15
Using the Dual Cook Feature(CE2974N/CE2974NT).....	16
Using the Crusty Plate (CE2974NT/CE2914NT).....	16
Crusty Plate Setting (CE2974NT/CE2914NT).....	17
Choosing the Heating Element Position.....	18
Choosing the Accessories.....	18
Grilling.....	19
Switching the Beeper Off (CE2974N/CE2974NT).....	21
Safety-Locking Your Microwave Oven (CE2974N/CE2974NT).....	21
Remembering Function (CE2974N/CE2974NT).....	22
Manual Stop Turntable Function.....	22
Cookware Guide.....	23
Cooking Guide.....	24
Cleaning Your Microwave Oven.....	31
Storing and Repairing Your Microwave Oven.....	31
Technical Specifications.....	32

## Quick Look-up Guide

GB

Model : CE2974N/CE2974NT

### If you want to cook some food

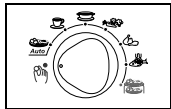

1. Place the food in the oven.  
Turn the **Cooking Control knob** to **Manual Cook**() symbol.

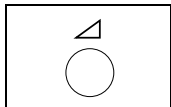

2. Select the power level by pressing the  button once or more times.

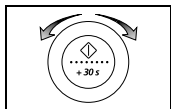

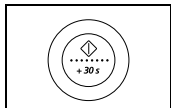

3. Select the cooking time by turning the **dial knob** as required.



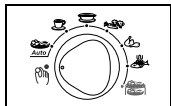

4. Press the  button.  
**Result:** Cooking starts.  
The oven beeps four times when cooking is over.

### If you want to defrost some food

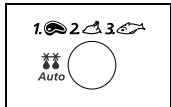

1. Place the frozen food in the oven.  
Turn the **Cooking Control knob** to **Manual Cook**() symbol.



2. Select the type of food by press the **Auto** () button once or more times.

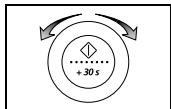



3. Select the cooking time by turning the **dial knob** as required.

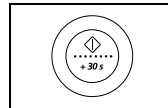

4. Press the  button.

### If you want to add an extra minute





- Leave the food in the oven.  
Turn the **Cooking Control knob** to **Manual Cook**() symbol. Press **+30s** once or more times for each extra 30 seconds that you wish to add.

### If you want to defrost some food

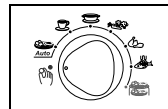

Check that the heating element is in the horizontal position.



1. Place the food in the oven.  
Turn the **Cooking Control knob** to **Manual Cook**() symbol.

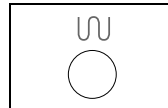

2. Press the  button.

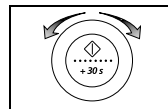

3. Select the cooking time by turning the **dial knob**.

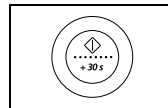

4. Press the  button.

## Quick Look-up Guide(Cautioned)

Model : CE2914N/CE2914NT

*If you want to cook some food*

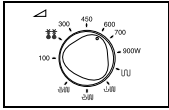

1. Place the food in the oven.  
Select the power level by rotating the **COOKING POWER CONTROL** knob.

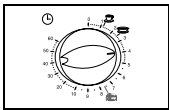

2. Select the cooking time by rotating the **TIMER** knob.

*If you want to defrost some food*

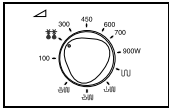

1. Turn the **COOKING POWER CONTROL** knob to defrost (☹☹) symbol.

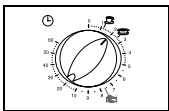

2. Turn the **TIMER** knob to select the appropriate time.

*If you want to adjust the cooking time*

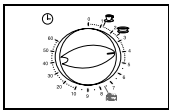

1. Leave the food in the oven.  
Turn the **TIMER** knob to desired time.

*If you want to grill some food (See page 18).*

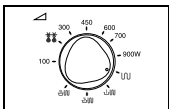

1. Turn the **COOKING POWER CONTROL** knob to Grill(U) symbol.

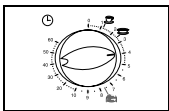

2. Turn the **TIMER** knob to select the appropriate time.

## Oven

Model : CE2974N/CE2974NT

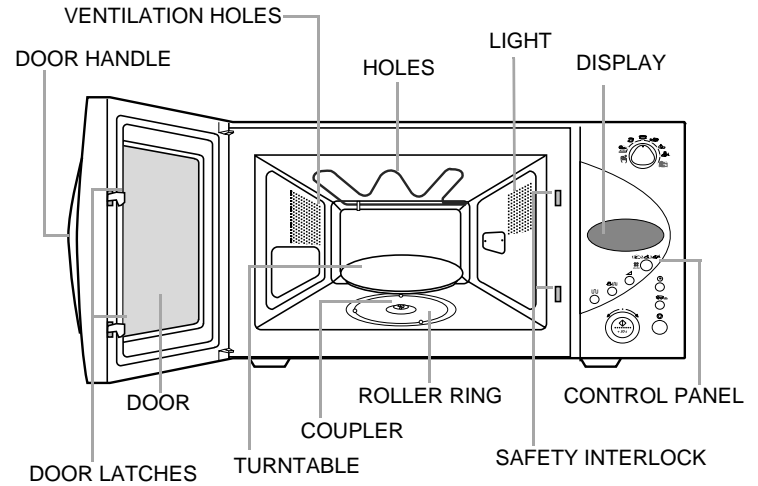

Model : CE2914N/CE2914NT

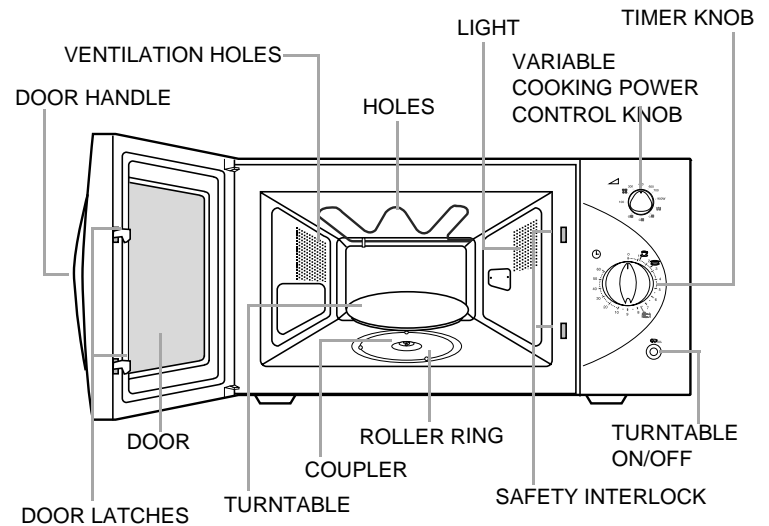

GB

# Control Panel

GB

Model : CE2974N/CE2974NT

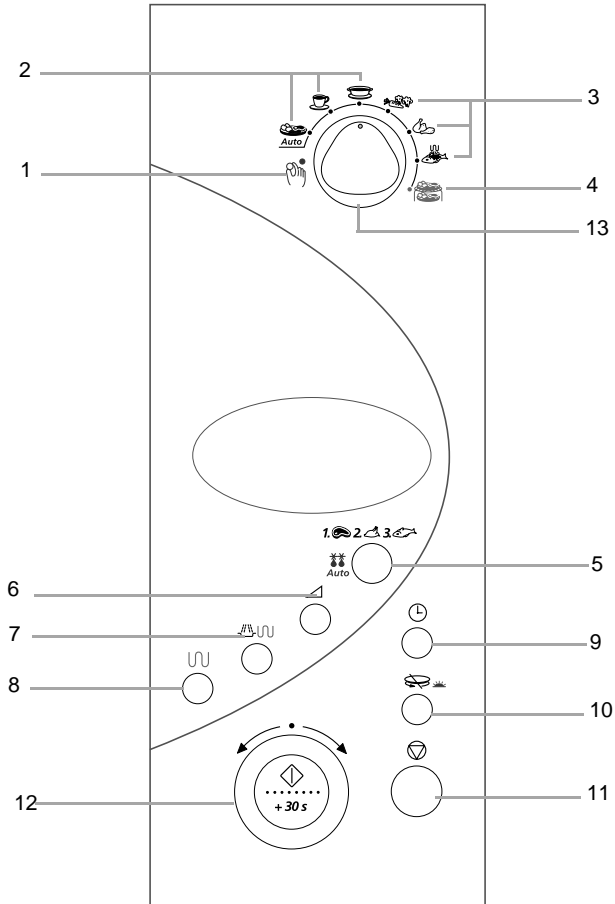

- |                                   |   |
|-----------------------------------|---|
| 1. MANUAL COOK SELECTION          | 8. GRILL MODE SELECTION   |
| 2. AUTO REHEAT SELECTION          | 9. CLOCK SETTING  |
| 3. AUTO COOK SELECTION            | 10. TURNTABLE ON/OFF  |
| 4. DUAL COOK SELECTION            | 11. STOP/CANCEL BUTTON  |
| 5. AUTO DEFROST FEATURE SELECTION | 12. START BUTTON/DIAL KNOB (cook time, weight and serving size) |
| 6. POWER LEVEL SETTING            | 13. COOKING CONTROL KNOB ROTATIVO                               |
| 7. COMBI MODE SELECTION           |   |

Model : CE2914N/CE2914NT

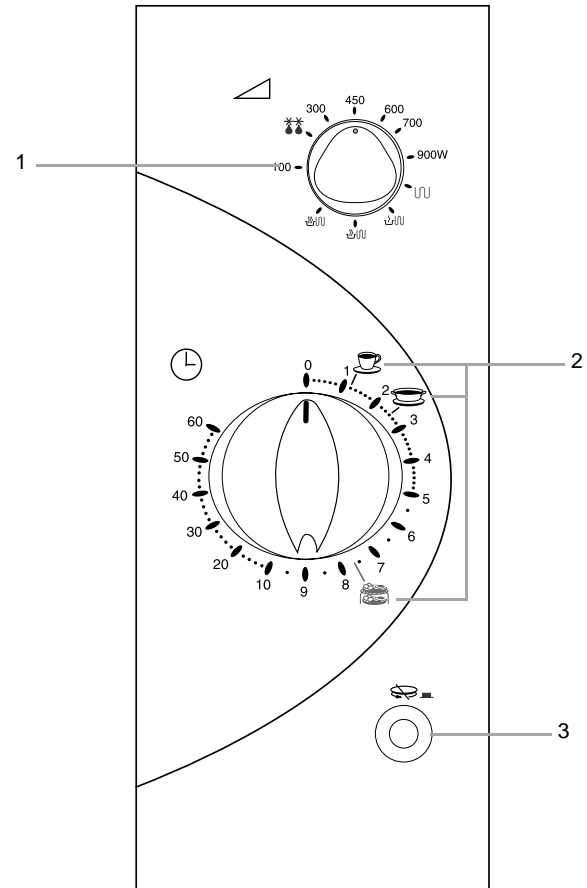

- |                     |
|---------------------|
| 1. DEFROST          |
| 2. INSTANT REHEAT   |
| 3. TURNTABLE ON/OFF |

## Accessories

Depending on the model that you have purchased, you are supplied with several accessories that can be used in a variety of ways.

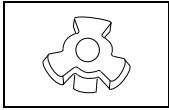

1. **Coupler**, already placed over the motor shaft in the base of the oven.

Purpose: The coupler rotates the turntable.

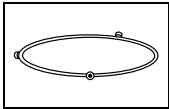

2. **Roller ring**, to be placed in the centre of the oven.

Purpose: The roller ring supports the turntable.

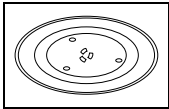

3. **Turntable**, to be placed on the roller ring with the centre fitting to the coupler.

Purpose: The turntable serves as the main cooking surface; it can be easily removed for cleaning.

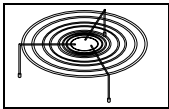

4. **Metal rack**, to be placed on the turntable.

Purpose: The metal rack can be used to cook two dishes at the same time. One dish may be placed on the turntable and the other dish on the rack. The metal rack can be used in grill and combination cooking.

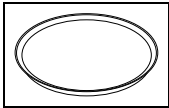

5. **Crusty plate(CE2974NT/CE2914NT only)**, see page 16.

Purpose: The crusty plate is used to brown food better in the microwave or grill combination cooking modes. It helps keep pasty and pizza dough crisp.



**DO NOT** operate the microwave oven without the roller ring and turntable.

## Using this Instruction Booklet

You have just purchased a SAMSUNG microwave oven. Your Owner's Instructions contain much valuable information on cooking with your microwave oven:

- Safety precautions
- Suitable accessories and cookware
- Useful cooking tips

Inside the cover you will find a quick look-up guide explaining four basic cooking operations:

- Cooking food
- Defrosting food
- Grilling food
- Adding extra cooking time

At the front of the booklet you will find illustrations of the oven, and more importantly the control panel, so that you can find the buttons more easily.

The step-by-step procedures use four different symbols.



**Important**



**Note**



**Caution**



**Turn**

### **PRECAUTIONS TO AVOID POSSIBLE EXPOSURE TO EXCESSIVE MICROWAVE ENERGY**

Failure to observe the following safety precautions may result in harmful exposure to microwave energy.

- Under no circumstances should any attempt be made to operate the oven with the door open or to tamper with the safety interlocks (door latches) or to insert anything into the safety interlock holes.
- Do not place any object between the oven door and front face or allow food or cleaner residues to accumulate on sealing surfaces. Ensure that the door and door sealing surfaces are kept clean by wiping after use first with a damp cloth and then with a soft dry cloth.
- Do not operate the oven if it is damaged until it has been repaired by a qualified microwave service technician trained by the manufacturer. It is particularly important that the oven door closes properly and that there is no damage to the:
  - Door, door seals and sealing surfaces
  - Door hinges (broken or loose)
  - Power cable
- The oven should not be adjusted or repaired by anyone other than a properly qualified microwave service technician trained by the manufacturer.

# Safety Precautions

GB

## Important Safety Instructions.

*Read Carefully and keep for future reference.*

*Before cooking food or liquids in your microwave oven, please check that the following safety precautions are taken.*

1. **DO NOT** use any metallic cookware in the microwave oven:
  - Metallic containers
  - Dinnerware with gold or silver trimmings
  - Skewers, forks, etc.

Reason: Electric arcing or sparking may occur and may damage the oven.
2. **DO NOT** heat:
  - Airtight or vacuum-sealed bottles, jars, containers.  
Ex) Baby food jars
  - Airtight food.  
Ex) Eggs, nuts in shells, tomatoes

Reason: The increase in pressure may cause them to explode.  
Tip: Remove lids and pierce skins, bags, etc.
3. **DO NOT** operate the microwave oven when it is empty.  
Reason: The oven walls may be damaged.  
Tip: Leave a glass of water inside the oven at all times. The water will absorb the microwaves if you accidentally set the oven going when it is empty.
4. **DO NOT** cover the rear ventilation slots with cloths or paper.  
Reason: The cloths or paper may catch fire as hot air is evacuated from the oven.
5. **ALWAYS** use oven gloves when removing a dish from the oven.  
Reason: Some dishes absorb microwaves and heat is always transferred from the food to the dish. The dishes are therefore hot.
6. **DO NOT** touch heating elements or interior oven walls.  
Reason: These walls may be hot enough to burn even after cooking has finished, even though they do not appear to be so. Do not allow inflammable materials to come into contact with any interior area of the oven. Let the oven cool down first.
7. To reduce the risk of fire in the oven cavity:
  - Do not store flammable materials in the oven
  - Remove wire twist ties from paper or plastic bags
  - Do not use your microwave oven to dry newspapers
  - If smoke is observed, keep the oven door closed and switch off or disconnect the oven from the power supply

8. Take particular care when heating liquids and baby foods.
  - ALWAYS allow a standing time of at least 20 seconds after the oven has been switched off so that the temperature can equalize.
  - Stir during heating, if necessary, and ALWAYS stir after heating.
  - Take care when handling the container after heating. You may burn yourself if the container is too hot.
  - A risk of delayed eruptive boiling exists.
  - To prevent delayed boiling and possible scalding, you should put a plastic spoon or glass stick into the beverages and stir before, during and after heating.  
Reason: During the heating of liquids the boiling point can be delayed; this means that eruptive boiling can start after the container is removed from the oven. You may scald yourself.
  - In the event of scalding, follow these FIRST AID instructions:
    - \* Immerse the scalded area in cold water for at least 10 minutes.
    - \* Cover with a clean, dry dressing.
    - \* Do not apply any creams, oils or lotions.
  - **NEVER** fill the container to the top and choose a container that is wider at the top than at the bottom to prevent the liquid from boiling over. Bottles with narrow necks may also explode if overheated.
  - **ALWAYS** check the temperature of baby food or milk before giving it to the baby.
  - **NEVER** heat a baby's bottle with the teat on, as the bottle may explode if overheated.
9. Be careful not to damage the power cable.
  - Do not immerse the power cable or plug in water and keep the power cable away from heated surfaces.
  - Do not operate this appliance if it has a damaged power cable or plug.
10. Stand at arm's length from the oven when opening the door.  
Reason: The hot air or steam released may cause scalding.
11. Keep the inside of the oven clean.  
Reason: Food particles or spattered oils stuck to oven walls or floor can cause paint damage and reduce the efficiency of the oven.
12. You may notice a "Clicking" sound during operation (especially when the oven is in defrosting).  
Reason: This sound is normal when the electrical power output is changing.
13. When the microwave oven is operating without any load, the power will be cut off automatically for safety. You can operate the oven normally after letting it stand for over 30 minutes.

## Safety Precautions(continued)

### IMPORTANT SAFETY INSTRUCTIONS

During cooking, you should look into the oven from time to time when food is being heated or cooked in disposable containers of plastic, paper or other combustible materials.

### IMPORTANT

Young children should NEVER be allowed to use or play with the microwave oven. Nor should they be left unattended near the microwave oven when it is in use. Items of interest to children should not be stored or hidden just above the oven.

## Installing Your Microwave Oven

Place the oven on a flat, level surface that strong enough to safely bear the weight of the oven.

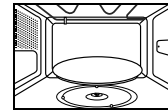
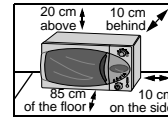

1. When you install your oven, make sure there is adequate ventilation for your oven by leaving at least 10 cm (4 inches) of space behind, and on the sides of the oven and 20 cm (8 inches) of space above the oven and 85 cm (thirty three inches) of the floor.
2. Remove all packing materials inside the oven. Install the roller ring and turntable. Check that the turntable rotates freely.
3. This microwave oven has to be positioned so that plug is accessible.

- \* **Never** block the air vents as the oven may overheat and automatically switch itself off. It will remain inoperable until it has cooled sufficiently.
- \* For your personal safety, plug the cable into a 3-pin, 230 Volt, 50Hz, AC earthed socket. If the power cable of this appliance is damaged, it must be replaced by the manufacturer or its service agent or a similarly qualified person in order to avoid a hazard.
- \* **Do not** install the microwave oven in hot or damp surroundings like next to a traditional oven or radiator. The power supply specifications of the oven must be respected and any extension cable used must be of the same standard as the power cable supplied with the oven. Wipe the interior and the door seal with a damp cloth before using your microwave oven for the first time.

GB

## Setting the Time (CE2974N/CE2974NT)

GB

Your microwave oven has an inbuilt clock. The time can be displayed in either the 24-hour or 12-hour notation. You must set the clock:

- When you first install your microwave oven
- After a power failure

✉ Do not forget to reset the clock when you switch to and from summer and winter time.

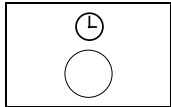

1. To display the time in the...Then press the  button...

24-hour notation      Once  
12-hour notation      Twice

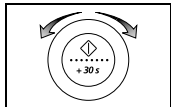

2. Turn the **dial knob** to set hour.

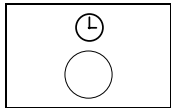

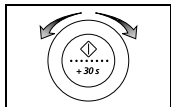

3. Press the **Clock** () button

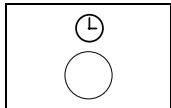

4. Turn the **dial knob** to set minute.



5. When the right time is displayed, press the  button again to start the clock and press the  button.  
**Result:** The time is displayed when ever you are not using the microwave oven.

## How a Microwave Oven Work

Microwaves are high-frequency electromagnetic waves; the energy released enables food to be cooked or reheated without changing either the form or the colour.

You can use your microwave oven to:

- Defrost
- Auto Reheat/Cook
- Cook

### Cooking Principle

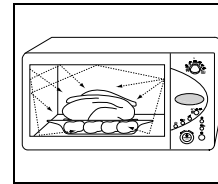

1. The microwaves generated by the magnetron are distributed uniformly as the food rotates on the turntable. The food is thus cooked evenly.
2. The microwaves are absorbed by the food up to a depth of about 1 inch (2.5 cm). Cooking then continues as the heat is dissipated within the food.
3. Cooking times vary according to the recipient used and the properties of the food:
  - Quantity and density
  - Water content
  - Initial temperature (refrigerated or not)



As the centre of the food is cooked by heat dissipation, cooking continues even when you have taken the food out of the oven. Standing times specified in recipes and in this booklet must therefore be respected to ensure:

- Even cooking of the food right to the centre
- The same temperature throughout the food

## Checking that Your Oven is Operating Correctly

The following simple procedure enables you to check that your oven is working correctly at all times.

Open the oven door by pulling on the handle on the right side of the door. Place a glass of water on the turntable. Then, close the door.

### Model : CE2974N/CE2974NT

Turn the cooking control knob to manual cook

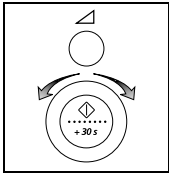

1. Press the  button and set the time to 4-5 minutes by turning the **dial knob** as required.

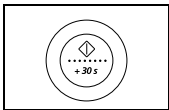

2. Press  button.  
**Result:** The oven heats the water for 4 to 5 minutes. The water should then be boiling.

### Model : CE2914N/CE2914NT

Turn the cooking control knob to manual cook

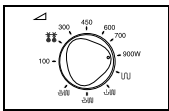

1. Set the power level to maximum by turning **COOKING POWER CONTROL** knob.

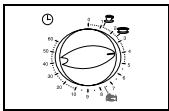



2. Set the time 4 to 5 minutes by turning the **TIMER** knob.  
**Result:** The water should then be boiling.

-  The oven must be plugged into an appropriate wall socket. The turntable must be in position in the oven. If a power level other than the maximum is used, the water takes longer to boil.

## What to Do if You are in Doubt or Have a Problem

If you have any of the problems listed below, try the solutions given.

GB

- ◆ This is normal.
  - Condensation inside the oven and display
  - Air flow around the door and outer casing
  - Light reflection around the door and outer casing
  - Steam escaping from around the door or vents
- ◆ The oven does not start when you press the  button.(CE2974N/CE2974NT)
  - Is the door completely closed?
- ◆ The oven does not start when you turn the **TIMER** knob.(CE2914N/CE2914NT)
  - Is the door completely closed?
- ◆ The food is not cooked at all
  - Have you set the timer correctly and/or pressed the  button? (CE2974N/CE2974NT)
  - Have you set the timer correctly? (CE2914N/CE2914NT)
  - Is the door closed?
  - Have you overloaded the electric circuit and caused a fuse to blow or a breaker to be triggered?
- ◆ The food is either overcooked or undercooked
  - Was the appropriate cooking length set for the type of food?
  - Was an appropriate power level chosen?
- ◆ Sparking and cracking occur inside the oven (arcing)
  - Have you used a dish with metal trimmings?
  - Have you left a fork or other metal utensil inside the oven?
  - Is aluminium foil too close to the inside walls?
- ◆ The oven causes interference with radios or televisions
  - Slight interference may be observed on televisions or radios when the oven is operating. This is normal. To solve this problem, install the oven away from televisions, radios and aerials.
  - If interference is detected by the oven's microprocessor, the display may be reset. To solve this problem, disconnect the power plug and reconnect it. Reset the time.(CE2974N/CE2974NT)
- ✉ If the above guidelines do not enable you to solve the problem, contact your local dealer or SAMSUNG after-sales service.

## Cooking / Reheating

GB

The following procedure explains how to cook or reheat food. **ALWAYS check your cooking settings before leaving the oven unattended.**

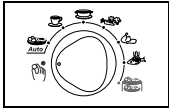

First, place the food in the centre of the turntable. Then, close the door.

### Model : CE2974N/CE2974NT

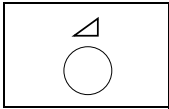

1. Turn the **Cooking Control knob** to **Manual Cook** (☑) symbol.



2. Press the  button.  
**Result:** The 900W (maximum cooking power) indications are displayed:  
Select the appropriate power level by pressing the  button again until the corresponding wattage is displayed. Refer to the power level table.

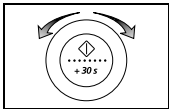

3. Set the cooking time by turning the **dial knob** as required.

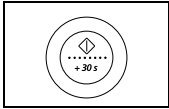

4. Press the  button.  
**Result:** The oven light comes on and the turntable starts rotating.
  - 1) Cooking starts and when it has finished the oven beeps four times.
  - 2) The end reminder signal will beep 3 times (once every minute).
  - 3) The current time is displayed again.

 **Never** switch the microwave oven on when it is empty.

 If you wish to heat a dish for a short period of time at maximum power(900W), simply press the **+30s** button once for each 30 seconds of cooking time. The oven starts immediately.

## Cooking / Reheating(Cautinued)

### Model : CE2914N/CE2914NT

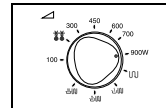

1. Set the power level to maximum by turning **COOKING POWER CONTROL** knob.  
**(MAXIMUM POWER : 900 W)**

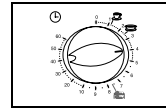

2. Set the time by turning **TIMER** knob.  
**Result:** The oven light comes on and the turntable starts rotating.



**Never** switch the microwave oven on when it is empty.



You can change the power level during cooking by turning the **COOKING POWER CONTROL** knob.

## Power Levels

You can choose among the power levels below.

Power Level	Output			
	CE2974N/CE2974NT		CE2914N/CE2914NT	
	MWO	GRILL	MWO	GRILL
HIGH REHEAT	900 W		950 W	
MEDIUM HIGH	600 W		600 W	
MEDIUM	450 W		450 W	
MEDIUM LOW	300 W		300 W	
DEFROST(☞☞)	180 W		180 W	
LOW	100 W		100 W	
GRILL	-	1300 W	-	1300 W
COMBI III	600 W	1300 W	300 W( ↓,↑ )	1300 W
COMBI II	450 W	1300 W	450 W( ↓,↑ )	1300 W
COMBI I	300 W	1300 W	600 W( ↓,↑ )	1300 W

- ☒ If you select higher power level, the cooking time must be decreased.
- ☒ If you select lower power level, the cooking time must be increased.

If you want to add the cooking time by turning dial knob. (CE2974N/CE2974NT)

Time	Increasing Time	Time	Increasing Time
up to 1 min	5 sec. unit	10 - 20 min	1 min unit
1 - 3 min	10 sec. unit	20 - 40 min	2 min unit
3 - 10 min	30 sec. unit	40 - 99 min	5 min unit

## Stopping the Cooking

You can stop cooking at any time to check the food.

### Model : CE2974N/CE2974NT

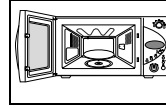

- To stop Timerarily;  
Open the door.  
**Result:** Cooking stops. To resume cooking, close the door and press ◊ again.

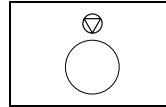

- To stop completely;  
Press the ◊ button.  
**Result:** The cooking stops.  
If you wish to cancel the cooking settings, press the **STOP/CANCEL** button again.



You can also cancel any setting before starting by simply pressing **Cancel** ◊.

### Model : CE2914N/CE2914NT

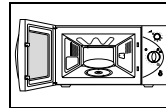

- To stop Timerarily;  
Open the door.  
**Result:** Cooking stops. To resume cooking, close the door.

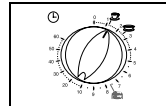

- To stop completely;  
Turn the **TIMER** knob to "0".

## Adjusting the Cooking Time

GB

### Model : CE2974N/CE2974NT

You can increase the cooking time by pressing the +30s button once for each 30 seconds to be added.

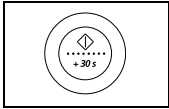

Press the **+30s** button once for each 30 seconds to be added.

 You can only adjust the time during cooking when the microwave, Auto reheat/cook, Gill and Combi modes are selected.

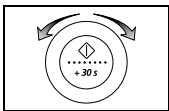

During the cooking to increase or decrease the cooking time of your food, turn the **dial knob** right or left.

### Model : CE2914N/CE2914NT

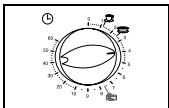

Adjust the remaining cooking time by rotating the **TIMER** knob.

## Using the Auto Reheat/Cook Feature (CE2974N/CE2974NT)

The Auto Reheat/Cook feature has six pre-programmed cooking time, you do not need to set either the cooking time or power level. You can adjust the number of servings by turning the dial knob.

First, place the food in the centre of the turntable and close the door.

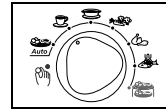

1. Turn the **Cooking Control Knob** to **Drinks** (☕) symbol. (Drink is the example)

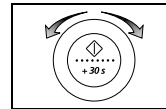

2. Select the size of the serving by turning the **dial knob**. (Refer to the table on the next page)

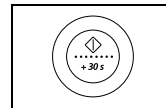

3. Press  button.

**Result:**





Cooking starts. When it has finished:

- 1) The oven beeps four times.
- 2) The end reminder signal will beep 3 times (once every minute).
- 3) The current time is displayed again.

 Use only recipients that are microwave-safe.

## Auto Reheat / Cook Settings(CE2974N/CE2974NT)

The following table presents the various Auto Reheat & Cook Programmes, quantities, standing times and appropriate recommendations.

Code/ Symbol	Serving Type	Portion	Standing Time	Recommendations
<b>H - 1</b> 	<b>Ready Meal</b> (frozen)	300-350 g 400-450 g 500-550 g	3 mins	Put on a ceramic plate and cover with microwave cling film. This programme is suitable for meals consisting of 3 components (e.g. meat with sauce, vegetables and a side dish like potatoes, rice or pasta).
	<b>H - 2</b> 	<b>Drinks</b> (coffee, milk, tea, water)	150 ml (1 cup) 300 ml (2 cups) 450 ml (3 cups) 600 ml (4 cups)	1-2 mins
<b>H - 3</b> 	<b>Soup/ Sauce</b> (Chilled)	200 - 250 ml 300 - 350 ml 400 - 450 ml 500 - 550 ml 600 - 650 ml	1-2 mins	Pour into a deep ceramic soup plate or bowl and cover during heating and standing. Stir carefully before and after standing time.
<b>A - 1</b> 	<b>Fresh Vegetables</b>	200 - 250 g 300 - 350 g 400 - 450 g 500 - 550 g 600 - 650 g 700 - 750 g	3 mins	Weigh the vegetables after washing, cleaning and cutting into a similar size. Put them into a glass bowl with lid. Add 45 ml (3 tablespoons) water when cooking 200-450 g, add 60 ml (4 tablespoons) for 500-650 g and add 75 ml (5 tablespoons) for 700-750 g. Stir after cooking. (When cooking bigger quantities, stir once during cooking.)
<b>A - 2</b> 	<b>Chicken pieces</b>	200-300 g (1pc) 400-500 g (2pcs) 600-700 g (2-3pcs) 800-900 g (3-4pcs)	3 mins	Brush the chicken pieces with oil and spice them with pepper, salt and paprika. Put them on the high rack with the skin-side down. Turn over when the oven beeps.

<b>A - 3</b> 	<b>Roast Fish</b>	200-300 g 400-500 g 600-700 g 800-900 g	3 mins	Brush skin of whole fish with oil and add herbs and spices. Put one fish diagonally on rack. Put two fishes side by side(head to tail) on rack. Turn over, as soon as the beep sounds.
---	-------------------	--	--------	--

GB

## Using the Instant Reheat/Cook Feature(CE2914N/CE2914NT)

GB

First, place the food in the centre of the turntable and close the door.

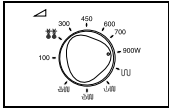

1. Turn the **COOKING POWER CONTROL** knob to Max Power.

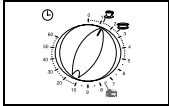

2. Turn the **TIMER** knob to select Instant Reheat. (drinks, soup/sauce or ready meal).

☒ Use only recipients that are microwave-safe.

## Instant Reheat/Cook Setting(CE2914N/CE2914NT)

Here are a few tips and recommendations to be followed when cooking or reheating food with the Instant Reheat and Cook Feature.

Symbol	Serving Type	Portion	Cooking Time	Standing Time	Cooking Power
	Drinks	150 ml	1 min 10 sec	1-2 mins	900 W
	Soup/Sauce	200-250 ml	2 min 30 sec	2 mins	900 W
	Ready Meal Chilled	2x300-350 ml	7 min 40 sec	3 mins	600 W

## Using the Auto Defrost Feature (CE2974N/CE2974NT)

The Auto Defrost feature enables you to defrost meat, poultry and fish. The defrost time and power level are set automatically. You simply select the programme and the weight.

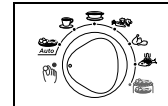

☒ Use only dishes that are microwave-safe.

First, place the frozen food in the centre of the turntable and close the door.

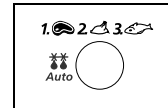

1. Turn the **Cooking Control knob** to **Manual Cook**() symbol.



2. Press the **Auto**() button. Press the **Auto**() button one or more times according to the type of food to be defrosted. Refer to the table on the opposite page for further details.

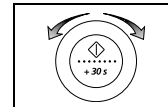

3. Select the food weight by turning the **dial knob**.

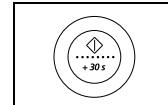

4. Press the  button.

**Result:**



- ◆ Defrosting begins.
- ◆ The oven beeps halfway through defrosting to remind you to turn the food over.
- ◆ Press  again to finish defrosting

☒ You can also defrost food manually. To do so, select the microwave cooking/reheating function with a power level of 180W. Refer to the section entitled "Cooking/Reheating" on page 10 for further details.

## Auto Defrost Settings(CE2974N/CE2974NT)

The following table presents the various Auto Defrost programmes, quantities, standing times and appropriate recommendations.

Remove all kinds of package material before defrosting. Place meat, poultry and fish on a turntable.

Code	Food	Portion	Standing Time	Recommendation
1	 Meat	0.2-2kg	20-60mins	Shield the edges with aluminium foil. Turn the meat over, when the oven beeps. This programme is suitable for beef, lamb, pork, steaks, chops, minced meat.
2	 Poultry	0.2-2kg	20-60mins	Shield the leg and wing tips with aluminium foil. Turn the poultry over, when the oven beeps. This programme is suitable for whole chicken as well as for chicken portions.
3	 Fish	0.2-2kg	20-50mins	Shield the tail of a whole fish with aluminium foil. Turn the fish over, when the oven beeps. This programme is suitable for whole fishes as well as for fish fillets.

## Manual Defrosting Food(CE2914N/CE2914NT)

The Defrost feature enables you to defrost meat, poultry or fish.

First, place the frozen food in the centre of the turntable. Then, close the door.

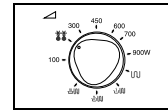

1. Turn the **COOKING POWER CONTROL** knob to .

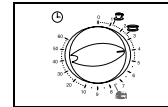

2. Turn the **TIMER** knob to select the appropriate time.  
**Result:** Defrosting begins.



Use only recipients that are microwave-safe.

## Using the Dual Cook Feature(CE2974N/ CE2974NT)

GB

Your Samsung microwave oven can cook two different foods at the same time using the Dual Cook Feature.



1. Place two READY MEALS in the oven, one on the turntable and the other on the metal rack, which is placed on the turntable.

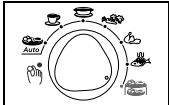

2. Turn the **Cooking Control knob** to **Dual Cook** (  ) symbol.

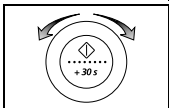

3. Select the food weight by turning the **dial knob**.



4. Press the  button.  
**Result:** Cooking starts after about two seconds. When it has finished
  - 1) The oven beeps four times.
  - 2) The end reminder signal will beep 3 times (once every minute).
  - 3) The current time is displayed again.



**When** using Dual Cook (heating 2 levels of food), always use the rack. Always use the metal rack, which should be put on the turntable.

Code/ Symbol	Serving Type	Portion	Standing Time	Recommendations
d - 1 	<b>Ready meal (Chilled)</b>	2x300-350g 2x400-450g	2 mins	Put each meal on a ceramic plate and cover it with microwave cling film. This programme is suitable for the meals consisting of 3 components (e.g. meat with sauce, vegetables and side dishes like potatoes, rice or pasta). Place one plate on the turntable and the other one the rack.

## Using the Crusty Plate (CE2974NT/CE2914NT)

Your Samsung microwave oven has a crusty plate as an additional accessory. This crusty plate allows you to brown food not only on the top with the grill, but also the bottom of the food turns crispy and brown due to the high temperature of the crusty plate. Several items which you can prepare on the crusty plate can be found in the chart (see next page).

The crusty plate can also be used for bacon, eggs, sausages, etc.

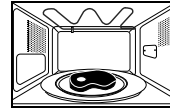

1. Place the crusty plate directly on the turntable and preheat it with highest Microwave-Grill-Combination[600W+Grill (  )] by following the times and instructions in the chart.
  - Always use oven gloves to take out the crusty plate, as it is becoming very hot.

2. Brush the plate with oil if you are cooking food, such as bacon and eggs, in order to brown the food nicely.
  - Please note that the crusty plate has a teflon layer which is not scratch-resis tant. Do not use any sharp objects like a knife to cut on the crusty plate.
  - Use plastic accessories to avoid scratches on the surface of the crusty plate or remove the food from the plate before cutting

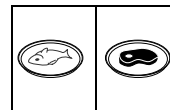

3. Place the food on the crusty plate.
  - Do not place any objects on the crusty plate that are not heat-resistant; e.g. plastic bowls.
  - Never place the crusty plate in the oven without turntable.

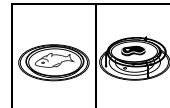

4. Place the crusty plate on the metal rack(or turntable) in the microwave.

5. Select the appropriate cooking time and power. Refer to the table on the next page.



### How to clean the Crusty Plate

Clean the crusty plate with warm water and detergent and rinse off with clean water.



Do not use a scrubbing brush or a hard sponge otherwise the top layer will be damaged.













### Please Note

The crusty plate is not dishwasher-safe.

## Crusty Plate Setting (CE2974NT/CE2914NT)

We recommend to preheat the crusty plate directly on the turn-table. Preheat the crusty plate with the 600W+Grill(  ) function and follow the times and instructions in the table.

Food	Portion	Power	Preheating Time	Cooking Time	Recommendations
<b>Bacon</b>	4 slices (80g)	600W+ Grill	3min.	3-3½min.	Preheat crusty plate. Put slices side by side on crusty plate. Put crusty plate on the rack.
	8 slices (160g)			4½ -5min.	
<b>Grilled Tomatoes</b>	200g (2pcs)	450W+ Grill	3min.	3min.	Preheat crusty plate. Cut tomatoes in halves. Put some cheese on top. Arrange in a circle on crusty plate. Put crusty plate on the rack.
	400g (4pcs)			4min.	
<b>Burger (frozen)</b>	2 pieces (125g)	600W+ Grill	3min.	6-6½ min	Preheat crusty plate. Put frozen burger in a circle on crusty plate. Put crusty plate on the rack. Turn over after 4-5 min.
	4 pieces (250g)			8-8½min.	
<b>Baguettes (frozen)</b>	100-150g (1pc)	450W+ Grill	5min.	5-6min.	Preheat crusty plate. Put one baguette beside the centre, 2 baguettes side by side on the plate. Put crusty plate on rack.
	200-250g (2pcs)			6-7min.	
<b>Pizza (frozen)</b>	300-350g	600W+ Grill	5min.	7-8min.	Preheat crusty plate. Put the frozen pizza on the crusty plate. Put crusty plate on the rack.
	400-450g			9-10min.	
<b>Mini Pizza (chilled)</b>	100-150g	600W+ Grill	5min.	3-3½min.	Preheat crusty plate. Put the chilled pizza pieces in a circle on the plate. Set crusty plate on the rack.
	200-250g			4-4½min.	
<b>Oven Chips (frozen)</b>	200g	450W+ Grill	4min.	9min.	Preheat crusty plate. Distribute oven chips on crusty plate. Put the plate on the rack. Turn over after half of cooking time.
	300g			12min.	
	400g			15min.	

<b>Baked Potatoes</b>	250g	600W+ Grill	4min.	4½-5min.	Preheat crusty plate. Cut potatoes in halves. Put them on the crusty plate with the cut side to the bottom. Arrange in a circle. Put the plate on the rack.
	500g			7-7½min.	
<b>Fish Fingers (frozen)</b>	150g (5pcs)	600W+ Grill	4min.	6-6½min.	Preheat crusty plate. Brush plate with 1 tbsp. Put fish fingers in a circle on the plate. Turn over after 3½ min (5 pcs) or after 5 min (10 pcs).
	300g (10pcs)			8½-9min.	
<b>Chicken Nuggets (frozen)</b>	125g	600W+ Grill	4min.	4½-5min.	Preheat crusty plate. Brush plate with 1 tbsp. Put chicken nuggets on the plate. Put crusty plate on the rack. Turn over after 3 min (125g) or 5 min (250g).
	250g			6½-7min.	

GB

## Choosing the Heating Element Position

GB

The heating element is used when grilling. It can be placed in one of two positions:

- **Horizontal position for grilling or combined microwave + grill cooking**

☞ Only change the position of the heating element when it is cold and do not apply excessive force when placing it in the vertical position.

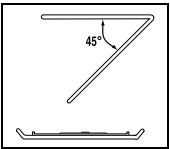
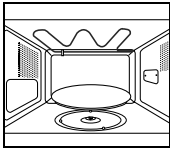

**To set the heating element to the...**

Horizontal position (grill or combined microwave + grill)

**Then...**

- ◆ Pull the heating element towards you
- ◆ Push it upwards until it is parallel with the roof of the oven

When cleaning the upper part inside the cavity, it will be convenient to turn heater downward by 45° and clean it.

## Choosing the Accessories

Use microwave-safe recipients; do not use plastic containers, dishes, paper cups, towels, etc.

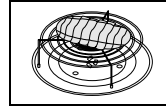

If you wish to select the combined cooking mode (grill and microwave), use only dishes that are microwave-safe and ovenproof. Metallic cookware or utensils may damage your oven.



For further details on suitable cookware and utensils, refer to the Cookware Guide on page 23.

# Grilling

The grill enables you to heat and brown food quickly, without using microwaves. To this aim, a grill rack (metal rack) is supplied with your microwave oven.

## Model : CE2974N/CE2974NT

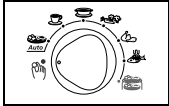

1. Turn the **Cooking Control knob** to **Manual Cook** (☐) symbol.



2. Preheat the grill to the required temperature, by pressing the ☐ button and set the preheat time by turning the **dial knob**.

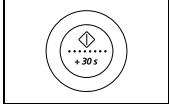

3. Press the ◊ button.

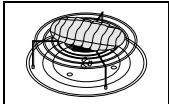

4. Open the door and place the food on the rack.

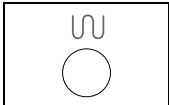

5. Press the ☐ button.  
**Result:** The following indications are displayed :

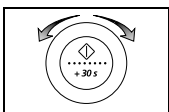
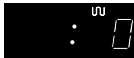

6. Set the cooking time by turning the **dial knob**.  
The maximum grilling time is 60 minute.

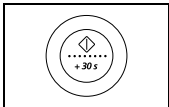

7. Press the ◊ button.  
**Result:** Grill cooking starts. When it has finished.
  - 1) The oven beeps four times.
  - 2) The end reminder signal will beep 3 times (once every minute).
  - 3) The current time is displayed again.

## Model : CE2914N/CE2914NT

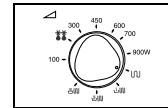

1. Preheat the grill to the required temperature, by the turning the cooking power control knob to grill symbol (☐) and turning the timer knob to the appropriate.

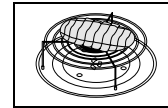

2. Open the door and place the food on the rack.

3. Select the appropriate cooking time.



Do not worry if the heater turns off and on while grilling. This system is designed to prevent overheating of the oven.



Always use oven gloves when touching the dishes in the oven, as they will be very hot.



Check that the heating element is in the horizontal position.

## Combining Microwaves and the Grill

GB

You can also combine microwave cooking with the grill, to cook quickly and brown at the same time.

 ALWAYS use microwave-safe and oven-proof cookware. Glass or ceramic dishes are ideal as they allow the microwaves to penetrate the food evenly.

ALWAYS use oven gloves when touching the recipients in the oven, as they will be very hot.

### Model : CE2974N/CE2974NT

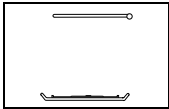

1. Make sure that the heating element is in the horizontal position; refer to page 18 for further details.

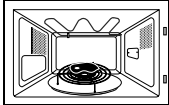

2. Open the oven door. Place the food on the rack and the rack on the turntable. Close the door.

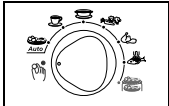

3. Turn the **Cooking Control knob** to **Manual Cook** (Manual Cook symbol).

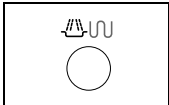

4. Press the **Combi** (Combi button) button.  
**Result:** Select the appropriate power level by pressing the **Combi** (Combi button) button again until the corresponding power level is displayed (600W, 450 W, 300 W).

- You cannot set the temperature of the grill.

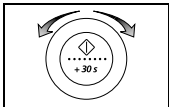

5. Set the cooking time by turning the **dial knob**. The maximum grilling time is 60 minute.

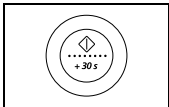

6. Press the **◇** button.  
**Result:** Combination cooking starts. When it has finished.
  - 1) The oven beeps four times.
  - 2) The end reminder signal will beep 3 times (once every minute).
  - 3) The current time is displayed again.

 The maximum microwave power for the combined microwave and grill mode is 600W.

### Model : CE2914N/CE2914NT

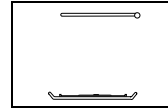

1. Make sure that the heating element is in the horizontal position; refer to page 18 for further details.

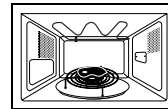

2. Open the oven door. Place the food on the rack and the rack on the turntable. Close the door.

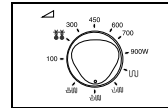

3. Turn the **Cooking Power Control knob** to the appropriate power Level (300W, 450W, 600W).

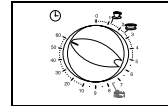



4. Turn the **Timer knob** to select the appropriate time. (Example : 60 mins)  
**Result:** Cooking starts.

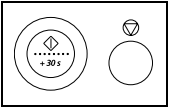

The maximum microwave power for the combined microwave and grill mode is 600W.

## Switching the Beeper Off (CE2974N/CE2974NT)





1. Press the  and  buttons at the same time.  
**Result:** The following indication is displayed.

**OFF**

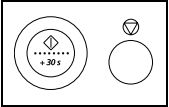
The oven does not beep each time you press a button or cooking ends.



2. To switch the beeper back on, press the  and  buttons again at the same time.  
**Result:** The following indication is displayed

**On**

The oven operates with the beeper on again.



## Safety-Locking Your Microwave Oven (CE2974N/CE2974NT)

GB

*Your microwave oven is fitted with a special Child Safety programme, which enables the oven to be “locked” so that children or anyone unfamiliar with it cannot operate it accidentally.*

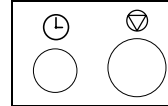
*The oven can be locked at any time.*





1. Press the  and  buttons at the same time.  
**Result:** The following indication is displayed.

**L**

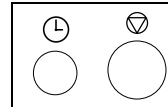
The oven is locked (no functions can be selected).



2. To unlock the oven, press the  and  buttons again at the same time.  
**Result:** The oven can be used normally.

## Remembering Function (CE2974N/CE2974NT)

GB

This oven remembers the last cooking power level for your convenience.

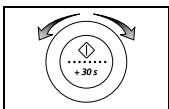

1. Set the add some cooking time by turning the **dial knob**.

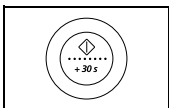

2. Press the  button.



- When cooking is over, the end reminder signal will beep 3 times. (Chime bell per 1min). And then, cooking mode will be "RESET" and the oven will forget the last cooking mode.
- If there's no operation after the door is opened and closed once, the cooking mode will be "RESET" after 30 seconds.
- Press the **Cancel** () button and then cooking mode will be "RESET".

## Manual Stop Turntable Function

The turntable on/off () button enables you to use large dishes which fill the whole oven by stopping the turntable from rotating.



The results will be less satisfactory in this case as the cooking is less even. We recommend that you turn the dish by hand halfway through the cooking process



**Warning!** Never operate the oven without local when turntable button is off.

- Result: This condition may cause fire and extreme damage to the oven.

### Model : CE2974N/CE2974NT

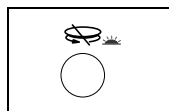

1. Press the **Turntable on/off** () button.  
Result: The following indication is displayed.



The turntable will not rotate.

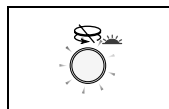

2. To switch the turntable rotating back on, press the **Turntable on/off** () button again.  
Result: The turntable will rotate.



Don't press **Turntable on/off** () button during cooking process. The turntable doesn't rotate when the lamp is "ON".

### Model : CE2914N/CE2914NT

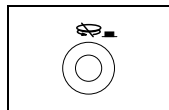

Push the **Turntable on/off** () button.

Result: If the turntable button can be pressed, it will rotate. If the turntable button is popped, it will not rotate.



Don't press **Turntable on/off** () button during cooking process.

## Cookware Guide

To cook food in the microwave oven, the microwaves must be able to penetrate the food, without being reflected or absorbed by the dish used.

Care must therefore be taken when choosing the cookware. If the cookware is marked microwave-safe, you do not need to worry.

The following table lists various types of cookware and indicates whether and how they should be used in a microwave oven.

Cookware	Microwave-Safe	Comments
Aluminium foil	✓ X	Can be used in small quantities to protect areas against overcooking. Arcing can occur if the foil is too close to the oven wall or if too much foil is used.
Browning plate	✓	Do not preheat for more than eight minutes.
China and earthenware	✓	Porcelain, pottery, glazed earthenware and bone china are usually suitable, unless decorated with a metal trim.
Disposable polyester cardboard dishes	✓	Some frozen foods are packaged in these dishes.
<b>Fast-food packaging</b>		
• Polystyrene cups containers	✓	Can be used to warm food. Overheating may cause the polystyrene to melt.
• Paper bags or newspaper	X	May catch fire.
• Recycled paper or metal trims	X	May cause arcing.
<b>Glassware</b>		
• Oven-to-table ware	✓	Can be used, unless decorated with a metal trim.
• Fine glassware	✓	Can be used to warm foods or liquids. Delicate glass may break or crack if heated suddenly.
• Glass jars	✓	Must remove the lid. Suitable for warming only.

<b>Metal</b>		
• Dishes	X	May cause arcing or fire.
• Freezer bag twist ties	X	
<b>Paper</b>		
• Plates, cups, napkins and Kitchen paper	✓	For short cooking times and warming. Also to absorb excess moisture.
• Recycled paper	X	May cause arcing.
<b>Plastic</b>		
• Containers	✓	Particularly if heat-resistant thermoplastic. Some other plastics may warp or discolour at high temperatures. Do not use Melamine plastic.
• Cling film	✓	Can be used to retain moisture. Should not touch the food. Take care when removing the film as hot steam will escape.
• Freezer bags	✓ X	Only if boilable or oven-proof. Should not be airtight. Prick with a fork, if necessary.
<b>Wax or grease-proof paper</b>	✓	Can be used to retain moisture and prevent spattering.

# Cooking Guide

GB

## MICROWAVES

Microwave energy actually penetrates food, attracted and absorbed by its water, fat and sugar content.

The microwaves cause the molecules in the food to move rapidly. The rapid movement of these molecules creates friction and the resulting heat cooks the food.

## COOKING

### Cookware for microwave cooking:

Cookware must allow microwave energy to pass through it for maximum efficiency. Microwaves are reflected by metal, such as stainless steel, aluminium and copper, but they can penetrate through ceramic, glass, porcelain and plastic as well as paper and wood. So food must never be cooked in metal containers.

### Foods suitable for microwave cooking:

Many kinds of food are suitable for microwave cooking, including fresh or frozen vegetables, fruit, pasta, rice, grains, beans, fish, and meat. Sauces, custard, soups, steamed puddings, preserves, and chutneys can also be cooked in a microwave oven. Generally speaking, microwave cooking is ideal for any food that would normally be prepared on a hob. Melting butter or chocolate, for example (see the chapter with tips, techniques and hints).

### Covering during cooking

To cover the food during cooking is very important, as the evaporated water rises as steam and contributes to cooking process. Food can be covered in different ways: e.g. with a ceramic plate, plastic cover or microwave suitable cling film.

### Standing times

After cooking is over food the standing time is important to allow the temperature to even out within the food.

## Cooking Guide for frozen vegetables

Use a suitable glass pyrex bowl with lid. Cook covered for the minimum time - see table. Continue cooking to get the result you prefer.

Stir twice during cooking and once after cooking. Add salt, herbs or butter after cooking. Cover during standing time..

Food	Portion	Power	Time (min. )	Standing Time (min. )	Instructions
Spinach	150g	600W	5-6	2-3	Add 15 ml (1 tablespoon) cold water.
Broccoli	300g	600W	8-9	2-3	Add 30 ml (2 tbsp.) cold water.
Peas	300g	600W	7-8	2-3	Add 15 ml (1 tbsp.) cold water.
Green Beans	300g	600W	7½-8½	2-3	Add 30 ml (2 tbsp.) cold water.
Mixed Vegetables (carrots/peas/corn)	300g	600W	7-8	2-3	Add 15 ml (1 tbsp.) cold water.
Mixed Vegetables (Chinese style)	300g	600W	7½-8½	2-3	Add 15 ml (1 tbsp.) cold water.

# Cooking Guide

## Cooking Guide for fresh vegetables

Use a suitable glass pyrex bowl with lid. Add 30-45 ml cold water (2-3 tbsp.) for every 250 g unless another water quantity is recommended - see table. Cook covered for the minimum time - see table. Continue cooking to get the result you prefer. Stir once during and once after cooking. Add salt, herbs or butter after cooking. Cover during a standing time of 3 minutes.

**Hint:** Cut the fresh vegetables into even sized pieces. The smaller they are cut, the quicker they will cook.

All fresh vegetables should be cooked using full microwave power (900 W).

Food	Portion	Time (min.)	Standing Time (min.)	Instructions
Broccoli	250g 500g	3½-4 6-7	3	Prepare even sized florets. Arrange the stems to the centre.
Brussels Sprouts	250g	5-5½	3	Add 60-75 ml (5-6 tbsp.) water.
Carrots	250g	3½-4	3	Cut carrots into even sized slices.
Cauliflower	250g 500g	4-4½ 6½-7½	3	Prepare even sized florets. Cut big florets into halves. Arrange stems to the centre.
Courgettes	250g	3-3½	3	Cut courgettes into slices. Add 30 ml (2 tbsp.) water or a knob of butter. Cook until just tender.
Egg Plants	250g	2½-3	3	Cut egg plants into small slices and sprinkle with 1 tablespoon lemon juice.
Leeks	250g	3-3½	3	Cut leeks into thick slices.
Mushrooms	125g 250g	1-1½ 2-2½	3	Prepare small whole or sliced mushrooms. Do not add any water. Sprinkle with lemon juice. Spice with salt and pepper. Drain before serving.
Onions	250g	4-4½	3	Cut onions into slices or halves. Add only 15 ml (1 tbsp.) water.
Pepper	250g	3½-4	3	Cut pepper into small slices.
Potatoes	250g 500g	3-4 6-7	3	Weigh the peeled potatoes and cut them into similar sized halves or quarters.
Turnip Cabbage	250g	4½-5	3	Cut turnip cabbage into small cubes.

## Cooking Guide for rice and pasta

**Rice:** Use a large glass pyrex bowl with lid - rice doubles in volume during cooking. Cook covered. After the cooking time is over, stir before standing time and salt or add herbs and butter. Remark: the rice may not have absorbed all water after the cooking time is finished.

**Pasta:** Use a large glass pyrex bowl. Add boiling water, a pinch of salt and stir well. Cook uncovered. Stir occasionally during and after cooking. Cover during standing time and drain thoroughly afterwards.

Food	Portion	Power	Time (min.)	Standing Time (min.)	Instructions
White Rice (parboiled)	250g 375g	900W	15-16 17½-18½	5	Add 500 ml cold water. Add 750 ml cold water.
Brown Rice (parboiled)	250g 375g	900W	20-21 22-23	5	Add 500 ml cold water. Add 750 ml cold water.
Mixed Rice (rice + wild rice)	250g	900W	16-17	5	Add 500 ml cold water.
Mixed Corn (rice + grain)	250g	900W	17-18	5	Add 400 ml cold water.
Pasta	250g	900W	10-11	5	Add 1000 ml hot water.

## REHEATING

Your microwave oven will reheat food in a fraction of the time that conventional ovens hobs normally take.

Use the power levels and reheating times in the following chart as a guide. The times in the chart consider liquids with a room temperature of about +18 to +20°C or a chilled food with a temperature of about +5 to +7°C.

### Arranging and covering

Avoid reheating large items such as joint of meat - they tend to overcook and dry out before the centre is piping hot. Reheating small pieces will be more successful.

### Power levels and stirring

Some foods can be reheated using 900 W power while others should be reheated using 600 W, 450 W or even 300 W.

Check the tables for guidance. In general, it is better to reheat food using a lower power level, if the food is delicate, in large quantities, or if it is likely to heat up very quickly (mince pies, for example).

Stir well or turn food over during reheating for best results. When possible, stir again before serving.

## Cooking Guide

GB

Take particular care when heating liquids and baby foods. To prevent eruptive boiling of liquids and possible scalding, stir before, during and after heating. Keep them in the microwave oven during standing time. We recommend putting a plastic spoon or glass stick into the liquids. Avoid overheating (and therefore spoiling) the food.

It is preferable to underestimate cooking time and add extra heating time, if necessary.

### Heating and standing times

When reheating food for the first time, it is helpful to make a note of the time taken - for future reference.

Always make sure that the reheated food is piping hot throughout.

Allow food to stand for a short time after reheating - to let the temperature even out. The recommended standing time after reheating is 2-4 minutes, unless another time is recommended in the chart.

Take particular care when heating liquids and baby food. See also the chapter with the safety precautions.

### REHEATING LIQUIDS

Always allow a standing time of at least 20 seconds after the oven has been switched off to allow the temperature to even out. Stir during heating, if necessary, and ALWAYS stir after heating. To prevent eruptive boiling and possible scalding, you should put a spoon or glass stick into the beverages and stir before, during and after heating.

### REHEATING BABY FOOD

#### BABY FOOD:

Empty into a deep ceramic plate. Cover with plastic lid. Stir well after reheating! Let stand for 2-3 minutes before serving. Stir again and check the temperature. Recommended serving temperature: between 30-40°C.

#### BABY MILK:

Pour milk into a sterilised glass bottle. Reheat uncovered. Never heat a baby's bottle with teat on, as the bottle may explode if overheated. Shake well before standing time and again before serving! Always carefully check the temperature of baby milk or food before giving it to the baby. Recommended serving temperature: ca. 37°C.

#### REMARK:

Baby food particularly needs to be checked carefully before serving to prevent burns.

Use the power levels and times in the next table as a guide lines for reheating.

### Reheating Liquids and Food

Use the power levels and times in this table as a guide lines for reheating.

Food	Portion	Power	Time (min. )	Standing Time (min. )	Instructions
Drinks (coffee, milk, tea, water with room temperature)	150 ml (1cup)	900W	1-1½	1-2	Pour into a ceramic cup and reheat uncovered. Place 1 cup in the centre, 2 opposite of each other and 3 or 4 in a circle. Stir carefully before and after standing time, be careful while taking them out of oven.
	300 ml (2cups)		1½-2		
	450 ml (3cups)		2½-3		
	600 ml (4cups)		3-3½		
Soup (chilled)	250g	900W	2-2½	2-3	Pour into a deep ceramic plate or deep ceramic bowl. Cover with plastic lid. Stir well after reheating. Stir again before serving.
	350g		2½-3		
	450g		3-3½		
	550g		3½-4		
Stew (chilled)	350g	600W	4½-5½	2-3	Put stew in a deep ceramic plate. Cover with plastic lid. Stir occasionally during reheating and again before standing and serving.
Pasta with sauce (chilled)	350g	600W	3½-4½	3	Put pasta (e.g. spaghetti or egg noodles) on a flat ceramic plate. Cover with microwave cling film. Stir before serving.
Filled pasta with sauce (chilled)	350g	600W	4-5	3	Put filled pasta (e.g. ravioli, tortellini) in a deep ceramic plate. Cover with plastic lid. Stir occasionally during reheating and again before standing and serving.
Plated Meal (chilled)	350g	600W	4½-5½	3	Plate a meal of 2-3 chilled components on a ceramic dish. Cover with microwave cling-film.
	450g		5-6		
	550g		5½-6½		

## Cooking Guide

### Guide for Dual Reheating

Use the power levels and times in this table as a guide lines for reheating.

Food	Portion	Power	Time	Standing Time (min. )	Instructions
Soup (chilled)	2 x 250g 2 x 350g	900 W	3½-4½ 5-6	2-3	Pour into two deep ceramic plates and cover. Put one plate directly on the turntable, other on the rack. Stir well after reheating. Stir again before serving.
Chicken Curry & Rice (chilled)	2 x 350g	600W	7-8½	3	Plate two meals of each 2 chilled components on two ceramic plates dishes. Cover with microwave cling-film. Put one plate directly on the turn table, other on the rack.
Plate Meal (chilled)	2 x 350g	600W	7½-9	3	Plate two meals of 2-3 chilled components on two flat ceramic plates. Cover with microwave cling-film. Put one plate directly on the turntable, other on the rack.

### Reheating Baby Food and Milk

Use the power levels and times in this table as guide lines for reheating.

Food	Portion	Power	Time	Standing Time (min. )	Instructions
Baby food (vegetables + meat)	190g	600W	30sec.	2-3	Empty into ceramic deep plate. Cook covered. Stir after cooking time. Stand for 2-3 minutes. Before serving, stir well and check the temperature carefully.
Baby porridge (grain + milk + fruit)	190g	600W	20sec.	2-3	Empty into ceramic deep plate. Cook covered. Stir after cooking time. Stand for 2-3 minutes. Before serving, stir well and check the temperature carefully.
Baby milk	100ml 200ml	300W	30-40 sec. 1 min. to 1 min. 10 sec.	2-3	Stir or shake well and pour into a sterilised glass bottle. Place into the centre of turntable. Cook uncovered. Shake well and stand for at least 3 minutes. Before serving, shake well and check the temperature carefully.

### DEFROSTING

Microwaves are an excellent way of defrosting frozen food. Microwaves gently defrost frozen food in a short period of time. This can be of great advantage, if unexpected guests suddenly show up.

Frozen poultry must be thoroughly thawed before cooking. Remove any metal ties and take it out of any wrapping to allow thawed liquid to drain away.

Put the frozen food on a dish without cover. Turn over halfway, drain off any liquid and remove any giblets as soon as possible. Check the food occasionally to make sure that it does not feel warm. If smaller and thinner parts of the frozen food start to warm up, they can be shield by wrapping very small strips of aluminium foil around them during defrosting.

Should poultry start to warm up on the outer surface, stop thawing and allow it to stand for 20 minutes before continuing. Leave the fish, meat and poultry to stand in order to complete defrosting. The standing time for complete defrosting will vary depending on the quantity defrosted. Please refer to the table below.

Hint: Flat food defrosts better than thick and smaller quantities need less time than bigger ones. Remember this hint while freezing and defrosting food.

For defrosting of frozen food with a temperature of about -18 to -20 °C, use the following table as a guide.

## Cooking Guide

GB

All frozen food should be defrosted using defrosting power level (180 W).

Food	Portion	Time (min. )	Standing Time (min. )	Instructions
Meat				
Minced beef	200g	6-7	15-30	Place the meat on a flat ceramic plate. Shield thinner edges with aluminium foil. Turn over after half of defrosting time!
Pork steaks	400g 250g	10-12 7- 8		
Poultry				
Chicken pieces	500g (2 pcs)	14-15	15-60	First, put chicken pieces first skin-side down, whole chicken first breast-side-down on a flat ceramic plate. Shield the thinner parts like wings and ends with aluminium foil. Turn over after half of defrosting time!
Whole chicken	1200g	32-34		
Fish				
Fish fillets/ Whole fis	200g 400g	6-7 11-13	10-25	Put frozen fish in the middle of a flat ceramic plate. Arrange the thinner parts under the thicker parts. Shield narrow ends of fillets and tail whole fish with aluminium foil. Turn over after half of defrosting time!
Fruits				
Berries	250g	6-7	5-10	Spread fruits on a flat, round glass dish (with a large diameter).
Bread				
Bread rolls (each ca. 50 g)	2pcs 4pcs	1-1½ 2½-3	5-20	Arrange rolls in a circle or bread horizontally on kitchen paper in the middle of turntable. Turn over after half of defrosting time!
Toast/ Sandwich	250g	4-4½		
German bread (wheat + rye flour)	500g	7-9		

### GRILL

The grill-heating element is located underneath the ceiling of the cavity. It operates while the door is closed and the turntable is rotating. The turntable's rotation makes the food brown more evenly. Preheating the grill for 4 minutes will make the food brown more quickly.

#### Cookware for grilling:

Should be flameproof and may include metal. Do not use any type of plastic cookware, as it can melt.

#### Food suitable for grilling:

Chops, sausages, steaks, hamburgers, bacon and gammon rashers, thin fish portions, sandwiches and all kinds of toast with toppings.

#### IMPORTANT REMARK:

Whenever the grill only mode is used, make sure that the grill-heating element is under the ceiling in the horizontal position and not on the back-wall in the vertical position. Please remember that food must be placed on the high rack, unless another instruction is recommended.

### MICROWAVE + GRILL

This cooking mode combines the radiant heat that is coming from the grill with the speed of microwave cooking. It operates only while the door is closed and the turntable is rotating. Due to the rotation of the turntable, the food browns evenly.

• Three combination modes are available with this model:

600 W + Grill, 450 W + Grill and 300 W + Grill.

#### Cookware for cooking with microwave + grill

lease use cookware that microwaves can pass through. Cookware should be flameproof. Do not use metal cookware with combination mode. Do not use any type of plastic cookware, as it can melt.

#### Food suitable for microwave + grill cooking:

Food suitable for combination mode cooking include all kinds of cooked food which need reheating and browning (e.g. baked pasta), as well as foods which require a short cooking time to brown the top of the food. Also, this mode can be used for thick food portions that benefit from a browned and crispy top (e.g. chicken pieces, turning them over half way through cooking). Please refer to the grill table for further details.

#### IMPORTANT REMARK:

Whenever the combination mode (microwave + grill) is used, make sure that the grill heating element is under the ceiling in the horizontal position and not on the back-wall in the vertical position. The food should be placed on the high rack, unless another instruction is recommended. Otherwise it has to be placed directly on the turntable. Please refer to the instructions in the following chart.

**The food must be turned over, if it is to be browned on both sides.**

# Cooking Guide

## Grill Guide for fresh food

Preheat the grill with the grill-function for 4 minutes.

Use the power levels and times in this table as guide lines for grilling.

Fresh Food	Portion	Power	1. Side Time (min)	2. Side Time (min)	Instructions
Toast Slices	4pcs (each25g)	Grill only	3½-4½	3-4	Put the toast slices side by side on the rack.
Bread Rolls (already baked)	2-4 pieces	Grill only	2½-3½	1½-2½	Put bread rolls first with the bottom side up in a circle directly on the turntable.
Grilled Tomatoes	200g (2pcs) 400g (4pcs)	300W + Grill	3½-4½ 5-6	-	Cut tomatoes into halves. Put some cheese on top. Arrange in a circle in a flat glass pyrex dish. Place it on the rack.
Tomato-Cheese Toast	4 pcs (300g)	300W + Grill	4-5	-	Toast the bread slices first. Put the toast with topping on the rack. Stand for 2-3 minutes.
Toast Hawaii (pineapple, ham, cheese slices)	2 pcs (300g) 4 pcs (600g)	450W + Grill	3½-4½ 6-7	-	Toast the bread slices first. Put the toast with topping on the rack. Put 2 toasts opposite directly on the rack. Stand for 2-3 minutes.
Baked Potatoes	250g 500g	600W + Grill	4½-5½ 6½-7½	-	Cut potatoes into halves. Put them in a circle on the rack with the cut side to the grill.
Gratin Potatoes/vegetables (chilled)	500g	450W + Grill	9-11	-	Put the fresh gratin into a small glass Grill pyrex dish. Put the dish on the rack. After cooking stand for 2-3 minutes.
Chicken Pieces	450g (2pcs) 650g (2-3pcs) 850g (4pcs)	300W + Grill	7-8 9-10 11-12	7-8 8-9 9-10	Brush chicken pieces with oil and spices. Put them in a circle with the bones to the middle. Put one chicken piece not into the centre of the rack. Stand for 2-3 minutes.
Roast Chicken	900g 1100g	450W + Grill	10-12 12-14	9-11 11-13	Brush chicken with oil and spices. Put chicken first breast side down, second side breast side up directly on turntable. Stand for 5 minutes after grilling.

## Grill Guide for fresh food

Fresh Food	Portion	Power	1. Side Time (min)	2. Side Time (min)	Instructions
Lamb Chops (medium)	400g (4pcs)	Grill only	10-12	8-9	Brush the lamb chops with oil and spices. Lay them in a circle on the rack. After grilling stand for 2-3 minutes.
Pork Steaks	250 g (2pcs) 500 g (4pcs)	MW + Grill	(300W+ Grill) 6-7 8-10	(Grill only) 5-6 7-8	Brush the pork steaks with oil and spices. Lay them in a circle on the rack. After grilling stand for 2-3 minutes.
Roast Fish	450g 650g	300W + Grill	6-7 7-8	7-8 8-9	Brush skin of whole fish with oil and herbs and spices. Put fish side by side (head to tail) on rack.
Baked Apples	2 apple (ca.400g) 4 apples (ca.800g)	300W + Grill	6-7 10-12	-	Core the apples and fill them with raisins and jam. Put some almond slices on top. Put apples on a flat glass pyrex dish. Place the dish directly on the turntable.

# Cooking Guide

GB

## Grill Guide for frozen food

Use the power levels and times in this table as guide lines for grilling.

Fresh Food	Portion	Power	1. Side Time (min)	2. Side Time (min)	Instructions
Bread Rolls (each ca. 50 g)	2 pcs 4 pcs	MW+ Grill	300W+ Grill 1½-2 2½-3	Grill only 2-3 2-3	Arrange rolls in a circle with the bottom side up directly on the turntable. Grill the second side of the rolls up to the crisp you prefer. Stand for 2-5 minutes.
Baguettes/ Garlic Bread	200-250 g (1pc)	MW+ Grill	450W+ Grill 3½-4	Grill only 2-3	Put frozen baguette diagonally on baking paper on the rack. After grilling stand for 2-3 minutes.
Gratin (vegetables or potatoes)	400g	450W+ Grill	13-15	-	Put frozen gratin into a small glass pyrex dish. Put the dish on the rack. After cooking stand for 2-3 minutes.
Pasta (Cannelloni, Macaroni, Lasagne)	400g	600W+ Grill	14-16	-	Put frozen pasta into a small flat rectangular glass pyrex dish. Put the dish directly on the turntable. After cooking stand for 2-3 minutes.
Fish Gratin	400g	450W+ Grill	16-18	-	Put frozen fish gratin into a small flat rectangular glass pyrex dish. Put the dish directly on the turntable. After cooking stand for 2-3 minutes.

## SPECIAL HINTS

### MELTING BUTTER

Put 50 g butter into a small deep glass dish. Cover with plastic lid. Heat for 30-40 seconds using 900 W, until butter is melted.

### MELTING CHOCOLATE

Put 100 g chocolate into a small deep glass dish. Heat for 3-5 minutes, using 450W until chocolate is melted. Stir once or twice during melting. Use oven gloves while taking out!

### MELTING CRYSTALLIZED HONEY

Put 20 g crystallized honey into a small deep glass dish. Heat for 20-30 seconds using 300 W, until honey is melted.

### MELTING GELATINE

Lay dry gelatine sheets (10 g) for 5 minutes into cold water. Put drained gelatine into a small glass pyrex bowl. Heat for 1 minute using 300 W. Stir after melting.

### COOKING GLAZE/ICING (FOR CAKE AND GATEAUX)

- Mix instant glaze (approximately 14 g) with 40 g sugar and 250 ml cold water. Cook uncovered in a glass pyrex bowl for 3½ to 4½ minutes using 900 W, until glaze/icing is transparent. Stir twice during cooking.

### COOKING JAM

Put 600 g fruits (for example mixed berries) in a suitable sized glass pyrex bowl with lid. Add 300 g preserving sugar and stir well. Cook covered for 10-12 minutes using 900 W. Stir several times during cooking. Empty directly into small jam glasses with twist-off lids. Stand on lid for 5 minutes.

### COOKING PUDDING

- Mix pudding powder with sugar and milk (500 ml) by following the manufacturers instructions and stir well. Use a suitable sized glass pyrex bowl with lid. Cook covered for 6½ to 7½ minutes using 900 W. Stir several times well during cooking.

### BROWNING ALMOND SLICES

Spread 30 g sliced almonds evenly on a medium sized ceramic plate. Stir several times during browning for 3½ to 4½ minutes using 600 W. Let it stand for 2-3 minutes in the oven. Use oven gloves while taking out!

## Cleaning Your Microwave Oven

The following parts of your microwave oven should be cleaned regularly to prevent grease and food particles from building up:

- **Inside and outside surfaces**
- **Door and door seals**
- **Turntable and Roller rings**

☞ ALWAYS ensure that the door seals are clean and the door closes properly.

1. Clean the outside surfaces with a soft cloth and warm, soapy water. Rinse and dry.
2. Remove any splashes or stains on the inside surfaces or on the roller ring with a soapy cloth. Rinse and dry.
3. To loosen hardened food particles and remove smells, place a cup of diluted lemon juice on the turntable and heat for ten minutes at maximum power.
4. Wash the dishwasher-safe plate whenever necessary.

☒ **DO NOT** spill water in the vents. NEVER use any abrasive products or chemical solvents. Take particular care when cleaning the door seals to ensure that no particles:

- Accumulate
- Prevent the door from closing correctly

☒ **Clean the** microwave oven cavity right after each use with a mild detergent solution, but let the microwave oven cool down before cleaning in order to avoid injury.

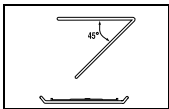

When cleaning the upper part inside the cavity, it will be convenient to turn heater downward by 45° and clean it.

## Storing and Repairing Your Microwave Oven

A few simple precautions should be taken when storing or having your microwave oven serviced.

The oven must not be used if the door or door seals are damaged:

- **Broken hinge**
- **Deteriorated seals**
- **Distorted or bent oven casing**

Only a qualified microwave service technician should perform repair.

☞ **NEVER** remove the outer casing from the oven. If the oven is faulty and needs servicing or you are in doubt about its condition:

- Unplug it from the wall socket
- Contact the nearest after-sales service centre

☒ If you wish to store your oven away temporarily, choose a dry, dust-free place.

- **Reason:** Dust and damp may adversely affect the working parts in the oven.

☒ This microwave oven is not intended for commercial use.

## Technical Specifications

## Note

GB

*SAMSUNG strives to improve its products at all times. Both the design specifications and these user instructions are thus subject to change without notice.*

<b>Model</b>	<b>CE2974N/CE2974NT/CE2914N/CE2914NT</b>
<b>Power source</b>	230V ~ 50 Hz
<b>Power consumption</b>	
Microwave	1400 W
Grill	1300 W
Combined mode	2700 W
<b>Output power</b>	100 W / 900 W -6 Level (IEC-705) : <b>CE2974N/CE2974NT</b> 100 W / 900 W - 7 Level (IEC-705) : <b>CE2914N/CE2914NT</b>
<b>Operating frequency</b>	2450 MHz
<b>Magnetron</b>	OM75P(31)
<b>Cooling method</b>	Cooling fan motor
<b>Dimensions (W x H x D)</b>	
Outside	517 x 297 x 424 mm
Oven cavity	336 x 241 x 349 mm
<b>Volume</b>	28 liter
<b>Weight</b>	
Net	18 kg approx









ELECTRONICS