

ROTEL hi-fi

ROTEL hi-fi

ROTEL hi-fi

ROTEL hi-fi

ROTEL hi-fi

ROTEL hi-fi

ROTEL hi-fi

ROTEL hi-fi

ROTEL hi-fi

ROTEL hi-fi

ROTEL hi-fi

ROTEL hi-fi

ROTEL hi-fi

ROTEL hi-fi

ROTEL hi-fi

ROTEL hi-fi

ROTEL hi-fi

ROTEL hi-fi

ROTEL hi-fi

ROTEL hi-fi

RTC-965

SURROUND SOUND TUNER PREAMPLIFIER

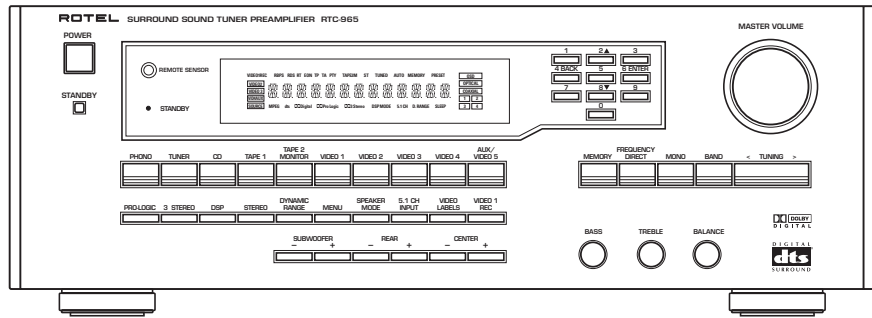

Owner's Manual



CAUTION
RISK OF ELECTRIC SHOCK
DO NOT OPEN



CAUTION: TO REDUCE THE RISK OF ELECTRIC SHOCK, DO NOT REMOVE COVER. NO USER-SERVICEABLE PARTS INSIDE. REFER SERVICING TO QUALIFIED SERVICE PERSONNEL.

APPLICABLE FOR USA, CANADA OR WHERE APPROVED FOR THE USAGE

CAUTION: TO PREVENT ELECTRIC SHOCK, MATCH WIDE BLADE OF PLUG TO WIDE SLOT. INSERT FULLY.

ATTENTION: POUR EVITER LES CHOCS ELECTRIQUES, INTRODUIRE LA LAME LA PLUS LARGE DE LA FICHE DANS LA BORNE CORRESPONDANTE DE LA PRISE ET POUSSER JUSQU'AU FOND.



This symbol is to alert the user to the presence of uninsulated dangerous voltages inside the product's enclosure that may constitute a risk of electric shock.



This symbol is to alert the user to important operating and maintenance (service) instructions in this manual and literature accompanying the product.

ANTENNA GROUNDING ACCORDING TO NATIONAL ELECTRICAL CODE INSTRUCTIONS ARTICLE 810: "RADIO AND TELEVISION EQUIPMENT"

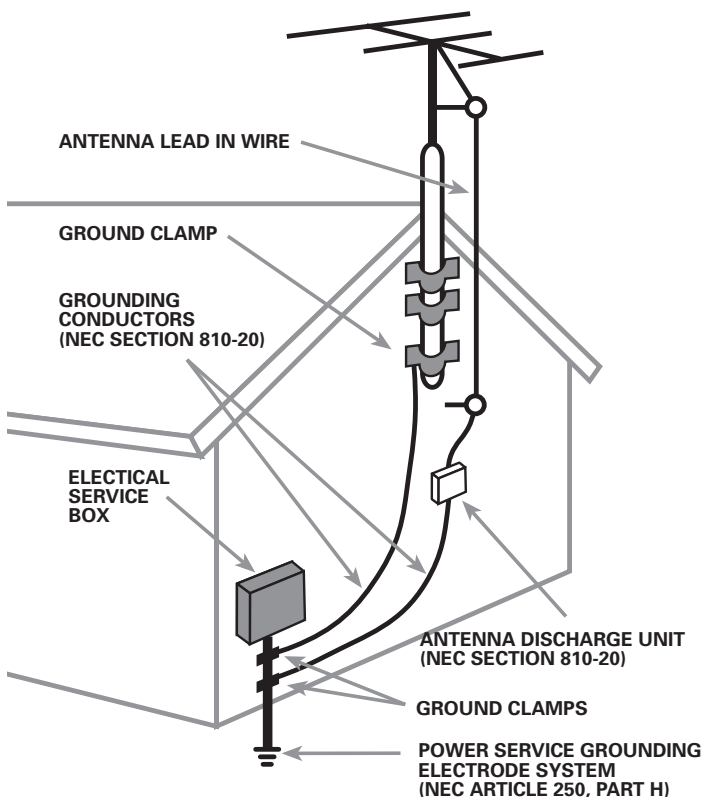

WARNING:

There are no user serviceable parts inside. Refer all servicing to qualified service personnel.

WARNING:

To reduce the risk of fire or electric shock, do not expose the unit to moisture or water. Do not allow foreign objects to get into the enclosure. If the unit is exposed to moisture, or a foreign object gets into the enclosure, immediately disconnect the power cord from the wall. Take the unit to a qualified service person for inspection and necessary repairs.

Read all the instructions before connecting or operating the component. Keep this manual so you can refer to these safety instructions.

Heed all warnings and safety information in these instructions and on the product itself. Follow all operating instructions.

Clean the enclosure only with a dry cloth or a vacuum cleaner.

Keep the ventilation inlets on the unit unobstructed. For example, do not place the unit on a bed, sofa, rug, or similar surface that could block the ventilation slots. If the unit is placed in a bookcase or cabinet, there must be sufficient clearance around the unit and ventilation of the cabinet to allow proper cooling.

Keep the component away from radiators, heat registers, stoves, or any other appliance that produces heat.

The unit must be connected to a power supply only of the type and voltage specified on the rear panel of the unit.

Connect the component to the power outlet only with the supplied power supply cable or an exact equivalent. Do not modify the supplied cable in any way. Do not attempt to defeat grounding and/or polarization provisions. The cable should be connected to a 2-pin polarized wall outlet, matching the wide blade of the plug to the wide slot of the receptacle. Do not use extension cords.

Do not route the power cord where it will be crushed, pinched, bent at severe angles, exposed to heat, or damaged in any way. Pay particular attention to the power cord at the plug and where it exits the back of the unit.

The power cord should be unplugged from the wall outlet if the unit is to be left unused for a long period of time.

Immediately stop using the component and have it inspected and/or serviced by a qualified service agency if:

- The power supply cord or plug has been damaged.
- Objects have fallen or liquid has been spilled into the unit.
- The unit has been exposed to rain.
- The unit shows signs of improper operation
- The unit has been dropped or damaged in any way

Place the unit on a fixed, level surface strong enough to support its weight. Do not place it on a moveable cart that could tip over.



NOTE TO CATV SYSTEM INSTALLER:

Call the CATV system or antenna installer's attention to Article 820-40 of the NEC. This provides guidelines for proper grounding and, in particular, specifies that the cable ground shall be connected to the grounding system of the building, as close to the point of cable entry as practical. See installation diagram.

NOTE:

This equipment has been tested and found to comply with the limits for a Class B digital device, pursuant to Part 15 of the FCC Rules. These limits are designed to provide reasonable protection against interference in a residential installation. This equipment generates and can radiate radio frequency energy and, if not installed and used in accordance with the instructions, may cause interference to radio or TV communications. There is no guarantee that interference will not occur in a particular installation. If this equipment does cause interference to radio or television reception, which can be determined by turning the equipment off and on, try to correct the interference by one or more of the following measures:

- Reorient or relocate the receiving antenna.
- Increase the separation between the unit and the television tuner.
- Connect the unit to an outlet on a different electrical circuit.
- Consult your authorized Rotel retailer for assistance.

Figure 1: Controls and Connections

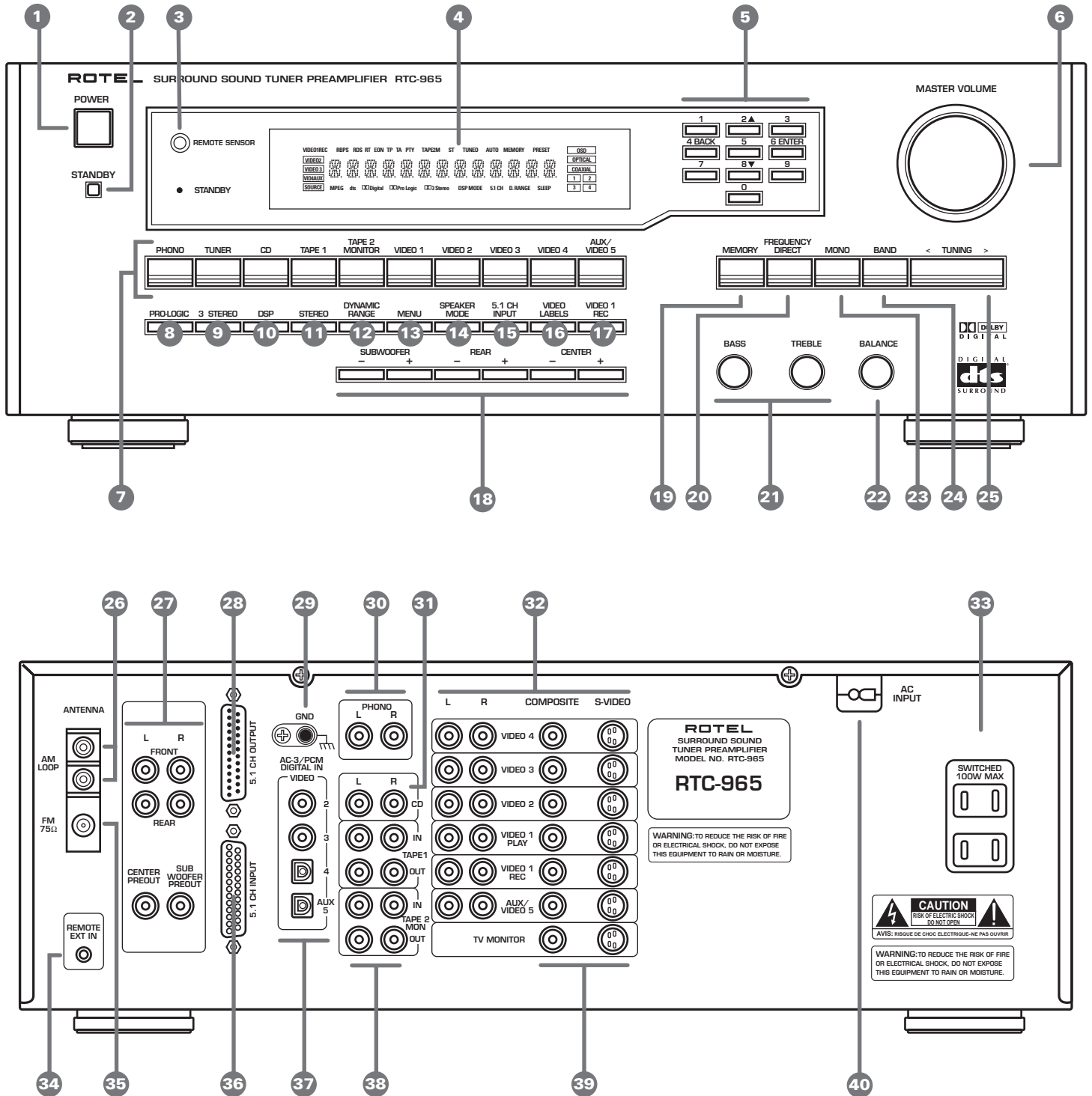
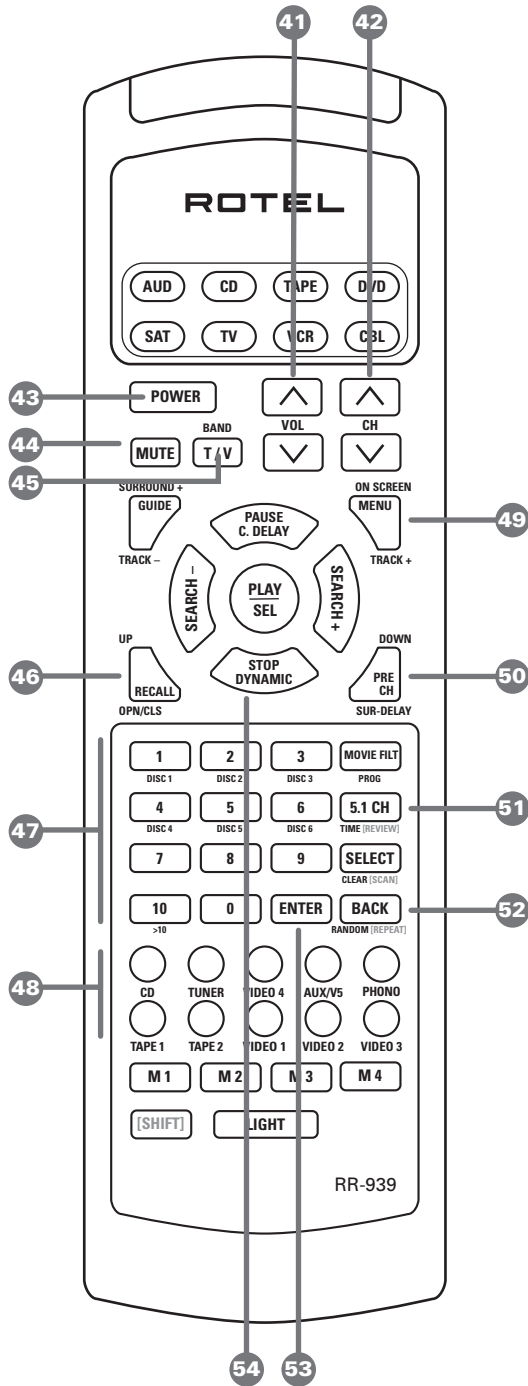

Figure 2: Remote Control



NOTE: See PROGRAMMING THE RR-939. Audio code for RTC-965 is code 001.

Figure 3: Antenna Connections

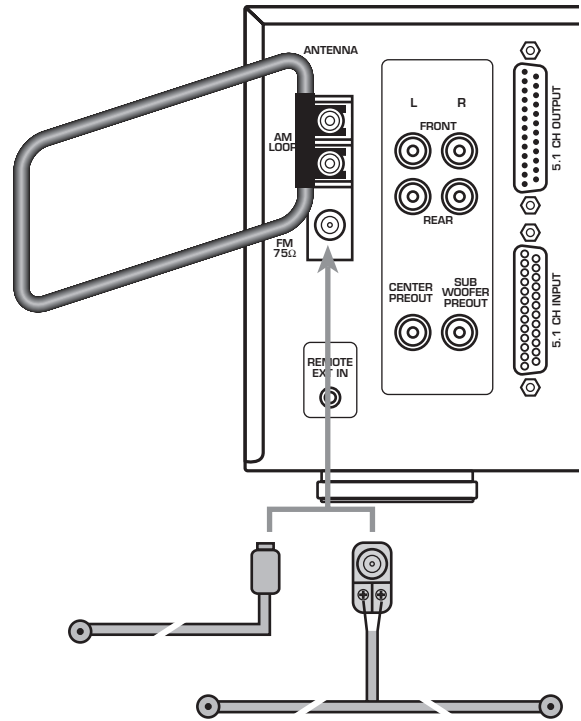
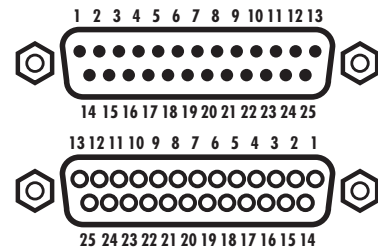

Figure 4: DB25 Connector Pin Assignments



- 1 left front +
- 2 center +
- 3 right front +
- 4 subwoofer +
- 5 left surround +
- 6 rear surround +
- 14 left front GND
- 15 center GND
- 16 right front GND
- 17 subwoofer GND
- 18 left surround GND
- 19 right surround GND

Figure 5: Output Connections

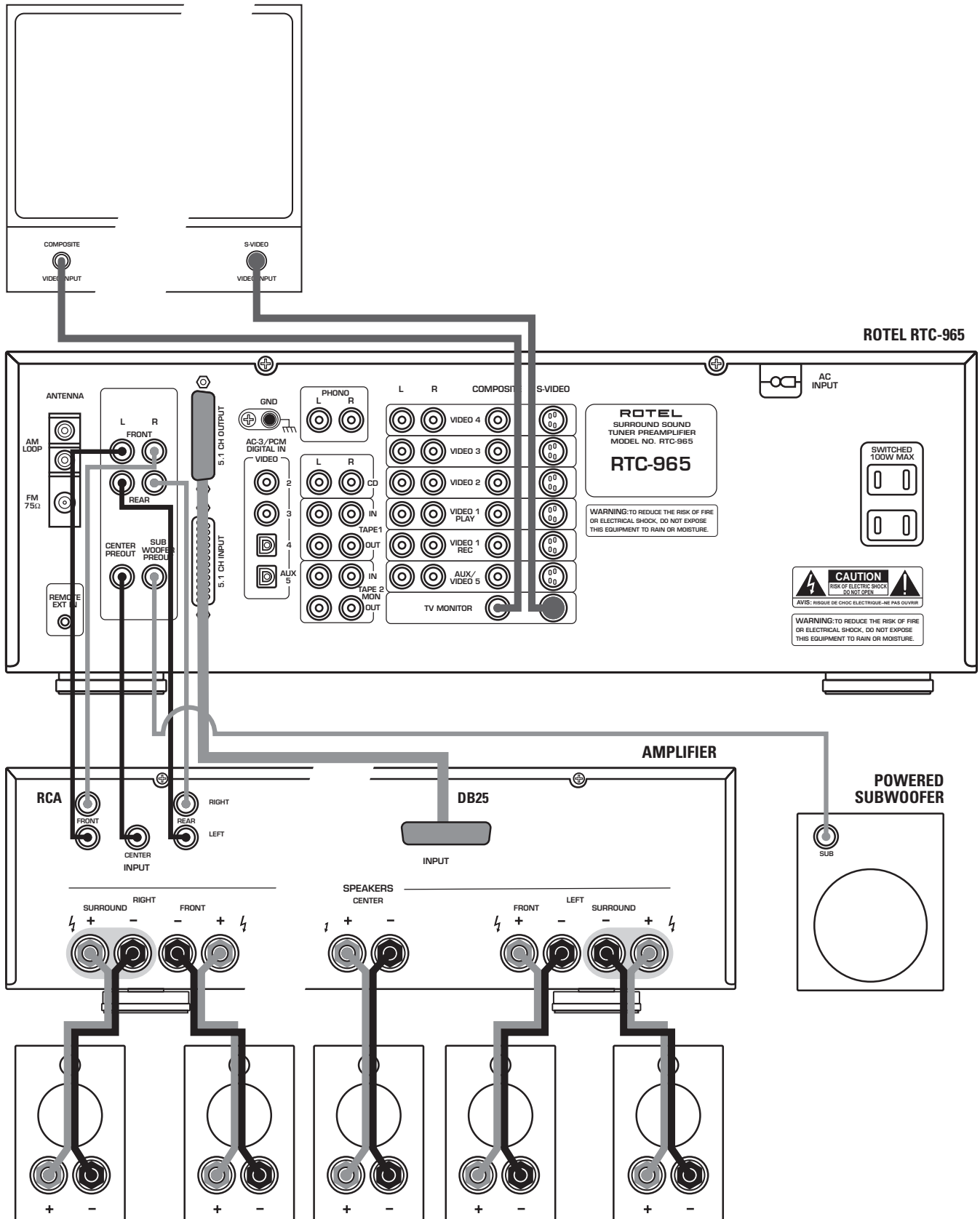

Figure 6: RCA Input Connections

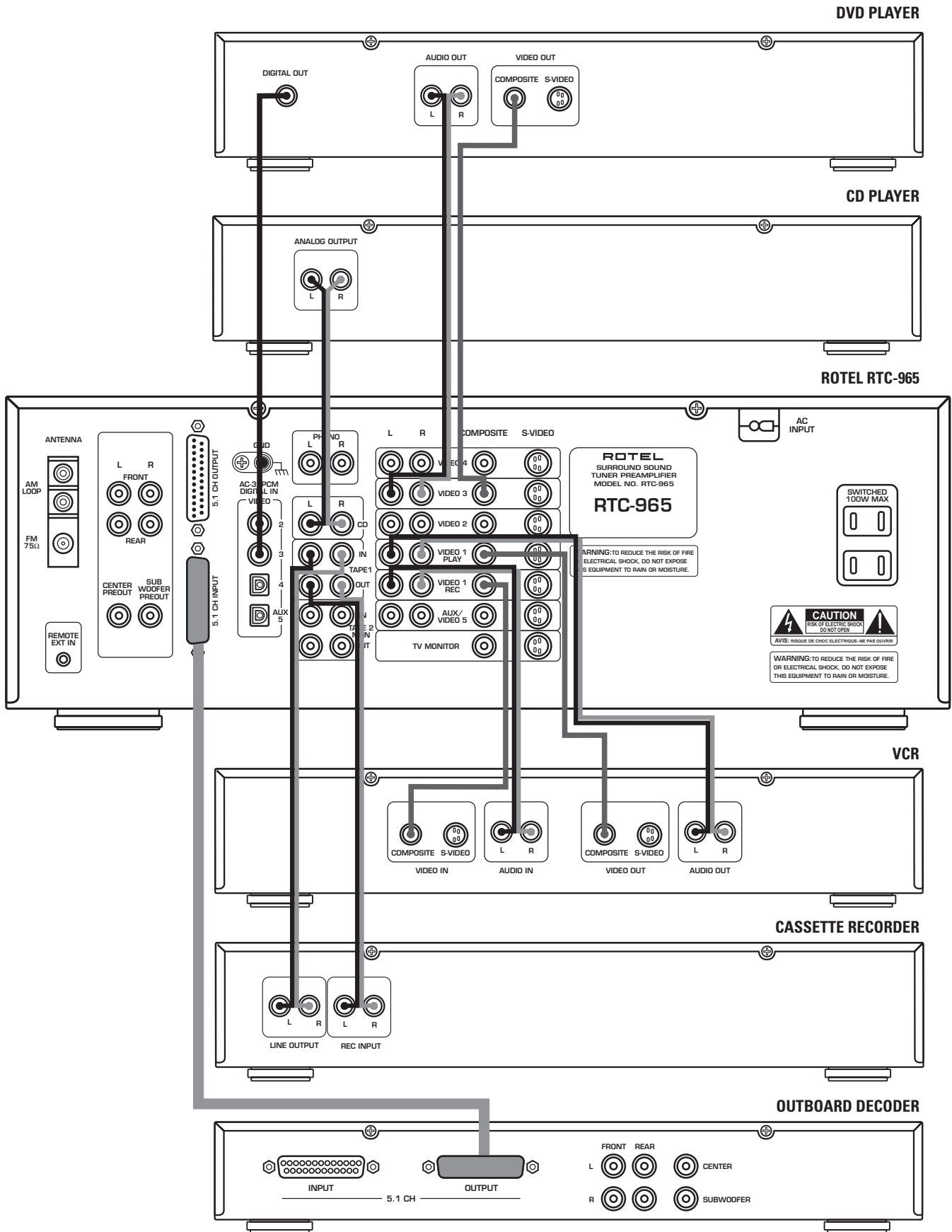

Figure 7: S-Video Input Connections

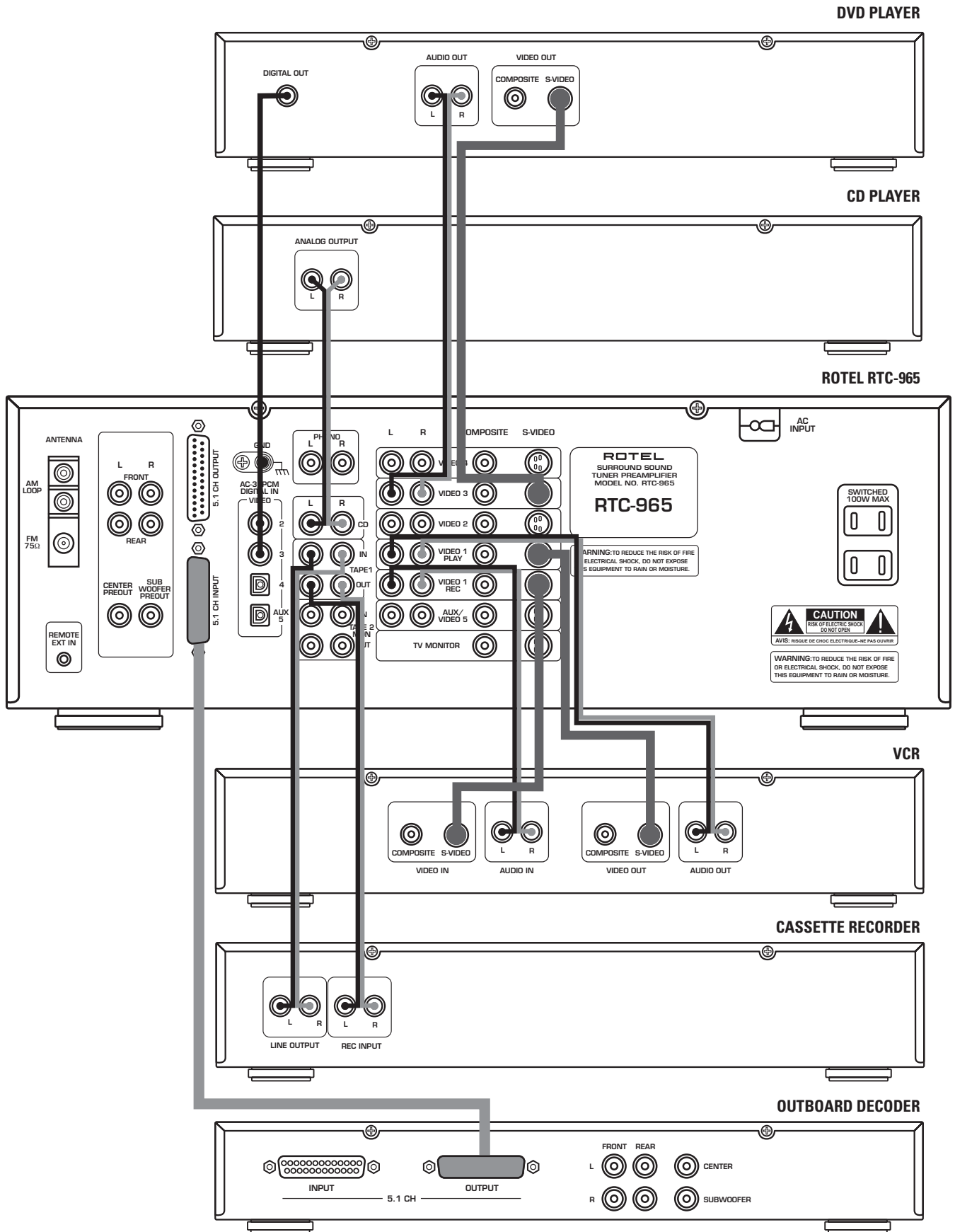
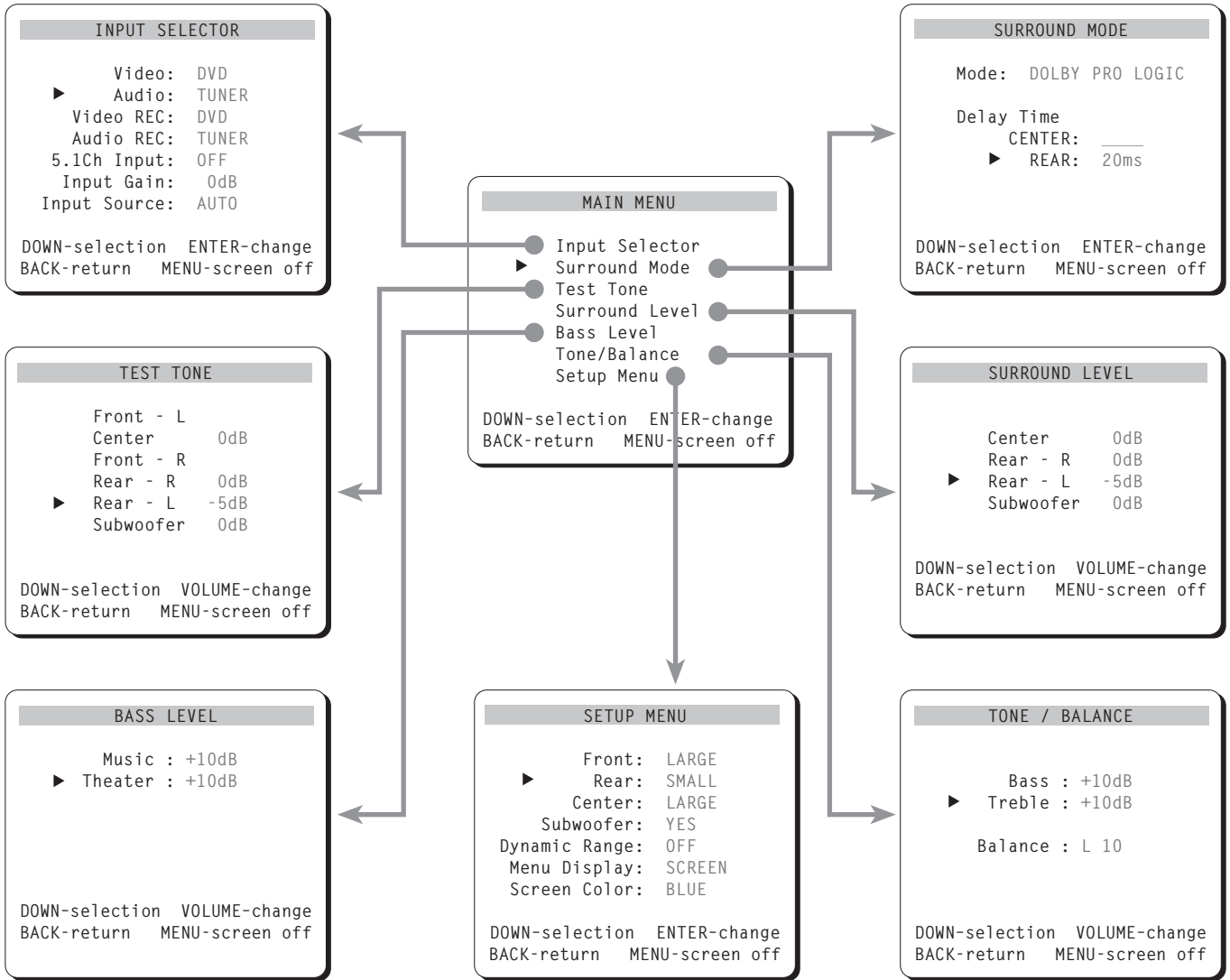

Figure 8: On-Screen Menus



Contents

Figure 1: Controls and Connections	3	RR-939 Remote Control	15
Figure 2: Remote Control	4	Programming the RR-939	16
Figure 3: Antenna Connections	4	POWER Button 43	16
Figure 4: DB25 Connector Pin Assignments	4	VOLUME Buttons 41	16
Figure 5: Output Connections	5	TUNING Button 42	16
Figure 6: RCA Input Connections	6	INPUT SOURCE Buttons 48	16
Figure 7: S-Video Input Connections	7	5.1 Button 51	16
Figure 8: On-Screen Menus	8	BAND Button 45	16
About Rotel	10	NUMERIC Buttons 47	16
Getting Started	10	DYNAMIC Button 54	16
RTC-965 Key Features	10	MUTE Button (remote only) 44	16
Unpacking	10	MENU button 49	16
Placement	10	Rear Panel Connections: Overview	16
Front Panel: Basic Controls	10	Rear Panel: Audio Source Connections	17
Power Switch 1 and Standby Switch 2 43	11	Phono Inputs 30 and Phono Ground 29	17
Remote Sensor 3	11	CD Inputs 31	17
Front Panel Display 4	11	Tape Inputs and Outputs 38	17
Master Volume Control 6 41	11	Rear Panel: Video Source Connections	17
Tone Controls 21	11	VIDEO 1 Inputs/Outputs 32	17
Balance Control 22	11	VIDEO 2 – 5 Inputs 32	17
SUBWOOFER/REAR/CENTER +/- Buttons 18	11	Digital Inputs 37	17
MEMORY Button 19	11	5.1 Channel Audio Input 36	18
Front Panel: Input Selection/Recording Controls	11	Rear Panel Output Signal Connections	18
Input Source Buttons 7	11	TV Monitor Output 39	18
5.1 CH Input 15 51	12	RCA Preamp Outputs 27	18
VIDEO 1 REC Button 17	12	5.1 CHANNEL Preamp Outputs 28	18
Front Panel: Surround Sound Controls	12	Rear Panel Antenna Connections	18
PRO LOGIC Button 8	12	AM Loop Antenna 26	18
3 STEREO Button 9	12	FM Wire Antenna 35	19
DSP Button 10	12	Rear Panel AC Power Connections	19
STEREO Button 11	13	AC Input 40	19
DYNAMIC RANGE Button 12 54	13	AC Convenience Outlets 33	19
Front Panel: Tuning Controls	13	Remote External Sensor Jack 34	19
BAND Button 24 45	13	On-Screen Display / Configuration	19
TUNING Button 25 42	13	Navigation Buttons 41 46 49 50 52 53	19
NUMERIC Keypad: Station Presets 5 47	13	MAIN Menu	20
FREQUENCY DIRECT Button 20	14	INPUT SELECTOR Menu	20
MONO Button 23	14	SURROUND MODE Menu	21
Front Panel: Configuration Controls	14	TEST TONE Menu	21
VIDEO LABEL Button 16	14	SURROUND LEVEL Menu	22
SPEAKER MODE Button 14	14	BASS LEVEL Menu	22
MENU Button 13 49	15	TONE/BALANCE Menu	22
		SETUP Menu	22
		RTC-965 Specifications	23

About Rotel

A family whose passionate interest in music led them to manufacture high fidelity components of uncompromising quality founded Rotel over 30 years ago. Through the years that passion has remained undiminished and the family goal of providing exceptional value for audiophiles and music lovers regardless of their budget, is shared by all Rotel employees.

The engineers work as a close team, listening to, and fine tuning each new product until it reaches their exacting musical standards. They are free to choose components from around the world in order to make that product the best they can. You are likely to find capacitors from the United Kingdom and Germany, semi conductors from Japan or the United States, while toroidal power transformers are manufactured in Rotel's own factory.

Rotel's reputation for excellence has been earned through hundreds of good reviews and awards from the most respected reviewers in the industry, who listen to music every day. Their comments keep the company true to its goal - the pursuit of equipment that is musical, reliable and affordable.

All of us at Rotel, thank you for buying this product and hope it will bring you many hours of enjoyment.

Getting Started

Thank you for purchasing the Rotel RTC-965 Surround Sound Tuner Preamplifier. The RTC-965 is four products in one:

1. A digital audio/video processor designed to decode Dolby® Pro Logic® analog surround signals plus Dolby Digital® and DTS® digital surround sound signals
2. A full-featured audio/video control center for analog and digital source components
3. A high-quality AM/FM tuner.

RTC-965 Key Features

- *Rotel's Balanced Design Concept combines advanced circuit board layout, comprehensive parts evaluation, and extensive listening tests for superior sound and long term reliability.*
- *Dolby® Pro Logic® decoding for analog sources*
- *Dolby Digital® and DTS® decoding for 5.1 channel digital sources*
- *5.1 channel input for outboard adaptor and future upgradeability*
- *User friendly On-Screen Display with programmable labels for video components.*

- *Comprehensive digital and analog input and output connections for audio and video sources, including digital inputs, composite video inputs and S-Video inputs*
- *AM/FM tuner with 30 station presets, direct access tuning, and auto-tuning.*
- *Programmable remote control to operate the RTC-965 and up to seven other components.*

Unpacking

Remove the unit carefully from its packing. Look for the handheld remote control and other accessories. Save the packing and box as it will protect the RTC-965 if you move or need to return it for maintenance.

Placement

Place the RTC-965 on a solid, dry, level surface away from direct sunlight, excessive heat, high humidity, or strong vibrations.

Make sure the RTC-965 is close to the other components in your audio/video system and, if possible, place it on its own shelf. This will make initial cable routing, hookup, and any subsequent system changes easier. It also minimizes potential interference or heat buildup from other components.

Make sure there is enough room behind the RTC-965 for easy hookup. Remember, you are connecting many other components to this unit and you'll probably need more space than you think.

Don't stack other objects (components or other items) on top of the RTC-965. Don't let water fall into the RTC-965 as this could damage delicate circuitry.

Front Panel: Basic Controls

We suggest you look over the RTC-965's front and rear panels before you start connecting other components to it. The following explanations will help you get familiar with the units connections, features, and controls, with number references corresponding to the illustrations at the front of this manual.

Most functions are duplicated on the front panel and on the handheld remote control shipped with your unit. A few may be available only on one or the other. When two reference numbers appear, one refers to the location of the button on the front panel, the other to the location of the button on the handheld remote control.

Note: Front panel controls and displays used for tuning the AM/FM receiver are described in the next section of this manual.

Power Switch 1 and Standby Switch 2 43

The RTC-965 has two pushbuttons for powering on and off. The POWER switch completely shuts down all of the circuitry, similar in effect to removing the power cord from the AC outlet. The STANDBY switch deactivates the unit, but preserves power to some circuits such as those that store memorized circuits. When in STANDBY mode, a front panel STANDBY LED indicator lights. The STANDBY Switch is duplicated on the RTC-965's remote.

In normal operation, use the STANDBY switch to deactivate the unit when you are finished listening and leave the POWER switch ON at all times. This will preserve memory functions.

Note: The STANDBY switch also controls the rear panel AC convenience outlets. When the RTC-965 is in STANDBY mode, the AC outlet is also off. When the RTC-965 is fully functional, the AC outlet is live.

Remote Sensor 3

This sensor receives infrared signals from the handheld remote control. Make sure you do not accidentally block this sensor with cables or accessories.

Front Panel Display 4

The large fluorescent display in the upper portion of the RTC-965 provides status information used in operating the AM/FM receiver (such as station frequency display, band, preset memory, etc.).

Master Volume Control 6 41

The MASTER VOLUME control adjusts the level of all output channels simultaneously. Rotate the control clockwise to increase the volume. Rotate counterclockwise to decrease the volume. MASTER VOLUME buttons are also available on the RTC-965's handheld remote control.

When you adjust the volume, a digital readout will appear in the RTC-965 front panel display and an indication of the new setting will appear on your TV monitor.

Tone Controls 21

BASS and TREBLE controls increase and decrease the audio signal's low and high frequency content respectively. Rotate clockwise to increase output in the respective frequency range and counterclockwise to reduce it. The center detent removes each control from the audio path for maximum signal integrity. The front panel display and an on-screen display will show tone control settings as you adjust them.

Balance Control 22

Turn the BALANCE control clockwise to increase the output level of the right channel speakers. Turn counterclockwise to increase the output level of the left channel speakers. The center detent position removes the control from the circuit and provides equal output from both left and right channels.

SUBWOOFER/REAR/CENTER +/- Buttons 18

These three pairs of buttons are used to adjust the output level of the subwoofer channel, the rear surround speakers, and the center channel speaker.

To change the output volume of the subwoofer, press the SUBWOOFER + or – buttons. To change the output volume of the rear surround channels press the REAR + or – buttons. To adjust the output of the center channel, press the CENTER + or – button.

Note: The same adjustments can also be made using the On-Screen menu system and test tones during system setup.

MEMORY Button 19

The MEMORY button is used to confirm and memorize various settings in the setup and operation of the RTC-965, including tuner station presets and video source labels. Its use is described in detail in the relevant sections below.

Front Panel: Input Selection/Recording Controls

Input Source Buttons 7

Ten large front panel buttons directly select an audio or video input source (such as a CD player, the built-in tuner, a tape recorder, video sources, etc.) for listening. Push any of these buttons (or the duplicates on the handheld remote) to select the desired source. You will hear this source and, if you have selected a video source, see its picture on your TV monitor.

Both the front panel display and the on-screen display will show the current source selection. These labels can be customized to match your components (see the VIDEO LABEL button below).

Note: Four video inputs accept analog audio/video signals and digital signals including Dolby Digital and DTS surround material. If a digital signal is present when the source is selected, the digital input is automatically activated and the proper surround choice enabled – unless the automatic sensing has been overridden for that input in the setup procedure described in the section on System Configuration. If no digital signal is present or if the auto sensing has been disabled, the analog inputs are selected.

TAPE MONITOR INPUTS: Two of the INPUT SOURCE buttons have a special function. The TAPE 1 and TAPE 2 MONITOR buttons activate the analog inputs of a tape monitor loop consisting of a pair of outputs and a matching set of inputs. Traditionally, this tape monitor loop has been used to play a tape deck connected to these inputs or for real time monitoring of a recording in progress on an audio tape deck. Alternatively, the tape monitor loop could be used to pass a signal to a graphic equalizer and listen to the processed signal by pressing the corresponding TAPE MONITOR button. An indicator appears in the front panel display when TAPE 2 MONITOR is activated.

5.1 CH Input 15 51

This button overrides all other inputs (both analog and digital) and directly connects an external digital adaptor to the RTC-965's MASTER VOLUME control and outputs. This allows the RTC-965 to remain the central controller for even the most advanced audio/video systems and provides an upgrade path to future software standards. When activated, all of the RTC-965's inboard Dolby processing is bypassed. An indicator appears in the front panel display and the on-screen display when the 5.1 CH input is activated.

The 5.1 CH button is duplicated on the handheld remote control.

VIDEO 1 REC Button 17

The RTC-965 permits recording from any source connected to the VIDEO 2 through 5 inputs to a VCR connected to the VIDEO 1 outputs while allowing simultaneous listening to another input source. To select a VIDEO INPUT SOURCE for recording, press the VIDEO 1 REC button. Each time you press the button, one of the VIDEO INPUT sources will be shown in the front panel display and selected for recording. For example, the first time you press the button, VIDEO 2 will be displayed as the recording source, a second press of the button will display VIDEO 3, and so on until you have cycled through VIDEO 4 and AUX/VIDEO 5 as well. Stop when you reach the input you wish to record from and its signal will be available to record on a VCR connected to the VIDEO 1 outputs. Remember, this selection is independent of the listening source. While recording, you may still select an audio source (for example, the CD or the TUNER input) for listening.

Note: The RECORD function requires analog signals. Thus, if you are using a digital connection from a CD player or DVD for listening, you should also connect an analog signal for recording. See the section on Rear Panel Input Connections.

To the contrary, many people find that they prefer one of the other surround modes. We have provided a note with each surround mode description suggesting when the setting may be appropriate along with alternative settings.

As a general rule, we recommend using PRO LOGIC mode for all sources labeled Dolby Pro Logic. Beyond that, use whatever settings sound best to **you** in **your** room with **your** system.

Note: Some users understandably find the choice of surround modes overwhelming, particularly until they have had a chance to live with the system and experiment for a while. Others simply prefer "set it and leave it" convenience. In both cases, we recommend PRO LOGIC mode as a satisfactory choice for virtually any source material.

PRO LOGIC Button 8

Provides proper playback decoding and processing for any Dolby Pro Logic encoded surround sound material, whether it be a music CD, videotape, videodisc, conventional stereo TV broadcast, or radio broadcast. It also can be used successfully to create additional ambience in 2-channel musical source material. Front, center, and rear speakers are activated and an indicator lights in the front panel display when the PRO LOGIC button is pressed.

Note: Many users will find that leaving the RTC-965 in the PRO LOGIC mode offers the most satisfactory performance and convenience for **all** source materials. It provides automatic decoding of analog surround sound material. It allows automatic selection (unless overridden) of digital processing when a Dolby Digital or DTS source is played. And, it provides very satisfying surround-sound ambience with musical sources.

3 STEREO Button 9

Provides the proper playback of Dolby Pro Logic source material on systems that have front and center speakers, but lack rear surround speakers. Adds the rear channel signals to the front speakers for a larger, more ambient sound than conventional stereo. An indicator lights in the front panel display to show that this mode has been activated.

DSP Button 10

This button activates digital synthesis of four different ambience modes (THEATER, HALL, STADIUM, and CHURCH) which simulate different acoustic environments and are primarily used to recreate ambience when listening to music sources and/or other sources that lack surround sound encoding. These five modes vary in the length and type of delay used for the rear surround channel signals. Experiment to find a setting which is most pleasing for a particular recording or broadcast. Press the button to activate the DSP mode. Each subsequent press of the button will step forward to the next mode in the following order: **THEATER > HALL > STADIUM > CHURCH**. An indicator lights in the front panel display when DSP mode has been activated.

Front Panel: Surround Sound Controls

The RTC-965 is equipped to properly decode Dolby® Pro Logic®, Dolby Digital®, and DTS® surround sound source material as well as synthesizing several different ambience simulations for musical source material.

Dolby Digital and DTS activation are fully automatic (unless the auto sensing is disabled during system setup). When a digital signal encoded with either of these surround signals is detected, the RTC-965 automatically activates the proper decoding. In most cases, the RTC-965 will also recognize a digital signal encoded with Dolby Pro Logic for automatic processing.

Additionally, five small buttons allow manual control of the surround sound/ambience settings as described below. Keep in mind that **there are no right or wrong settings**. Just because a mode is labelled STEREO does not mean that you must use this mode every time you play a stereo CD or listen to a stereo FM broadcast.

Note: As a general rule, the DSP modes provide more exaggerated ambience effects than playing the same recording in PRO LOGIC mode, which provides a subtle ambience synthesis on musical recordings. You may prefer PRO LOGIC as your “everyday” setting, experimenting with the more spectacular DSP modes for particular recordings or effects.

STEREO Button 11

Activates conventional 2-speaker stereo direct bypass mode with no surround sound or other processing. This is “pure” stereo, using the front left and front right speakers only, with no surround channels and no center channel.

When used with Dolby Digital or DTS source material, the STEREO button engages a “downmix” feature which combines all of the available channels and sends them to the front speakers only. The spatial effects of surround sound are lost, but all of the information on the original recording will be heard in 2-channel stereo.

Note 1: We provide the STEREO mode as an alternative for those who want to hear the recording in its original two-channel form, as if it were being played over a conventional 2-speaker stereo system. Conversely, many listeners find that they prefer the additional ambience from multi-speaker surround sound processing of 2-channel music recordings. We suggest PRO LOGIC mode for subtle ambience synthesis or the DSP modes for more spectacular effects. Use the setting that sounds best to you.

DYNAMIC RANGE Button 12 54

Today’s digital sources are capable of extremely high dynamic range (the difference between the softest and loudest sounds). In some cases, the available dynamic range may tax amplifiers and/or speakers. In other cases, it may be desirable to reduce the dynamic range, for example, when listening at low volume levels. Pressing the DYNAMIC RANGE button steps through the three available dynamic range settings:

- **OFF (no compression/full dynamic range)**
- **MID (moderate compression)**
- **MIN (maximum compression/minimum dynamic range).**

An indicator lights on the front panel display to show the current selection.

Note: The DYNAMIC RANGE feature is only available in Dolby Digital. It is inactive at all other times.

Front Panel: Tuning Controls

The RTC-965 features a digital synthesized AM/FM tuner with 30 station presets. Operation of the tuning functions involves the use of the numeric buttons immediately to the left of the MASTER VOLUME knob and five buttons directly below the MASTER VOLUME knob as described below.

BAND Button 24 45

The BAND button selects whether the tuner is in AM or FM mode. Press the button to toggle back and forth between AM and FM. A corresponding indicator will light at the left portion of the front panel display to confirm your choice and the currently tuned station frequency will be shown.

TUNING Button 25 42

This is a rocker switch used to change the station frequency up or down. The TUNING button gives you a choice of two tuning methods: manual and automatic.

To tune manually, press the button quickly and release to increase or decrease the station frequency to the next available setting, whether or not there is a station broadcasting on that frequency. Use a succession of quick button presses to reach the desired station.

To tune automatically, press and hold the TUNING button for approximately one second. An AUTO indicator will appear in the front panel display and the tuner will begin automatically scanning up or down through the frequencies until the next available station is detected. If this is not the desired station, repeat the automatic tuning procedure to find the next station. Weak stations will be skipped during auto tuning.

Several indicators in the front panel display assist tuning. A large display shows the tuned frequency and increases or decreases during tuning. A signal strength indicator shows the strength of the incoming signal. A TUNED indicator lights when a sufficiently strong signal is received. A ST indicator lights when a stereo FM signal is received.

NUMERIC Keypad: Station Presets 5 47

The RTC-965 can store up to 30 station presets for recall at any time using the NUMERIC keypad. To memorize a station:

1. Tune to the desired station, either AM or FM.
2. Press the MEMORY button on the front panel of the RTC-965. A MEMORY indicator will flash for five seconds in the display.
3. While the MEMORY indicator is flashing, press the number of the preset where you wish to store the station frequency. For example, to memorize the station as preset 3, press the 3 button. To memorize preset 15, press the 1 button followed by the 5 button.
4. A previously stored frequency is erased from memory when a new frequency is memorized for the same preset number.

To tune to a previously memorized station, just press the preset number on the NUMERIC keypad. For example, to tune to preset 3, press the 3 button. To tune to preset 15, press the 1 button and then press the 5 button.

Note: If the TUNER is not already the selected INPUT SOURCE, selecting a station preset will automatically switch to the TUNER input and tune the memorized station.

The NUMERIC keypad buttons can also be used for direct access tuning (see below). In addition, four of the buttons (▲▼ / BACK / ENTER) are used in navigating the on-screen menu system.

FREQUENCY DIRECT Button 20

If you know the frequency of the desired station, you may tune it directly using the FREQUENCY DIRECT button and the NUMERIC keypad.

1. Press the FREQUENCY DIRECT button to change the NUMERIC keypad from station preset to Direct Access mode. The station frequency in the front panel display will change to a series of four bars, representing the digits of a station frequency, with the first bar flashing.
2. Enter the first digit of the station frequency using the NUMERIC keypad. The digit will appear in the frequency display and the second bar will flash. Enter the remaining digits of the frequency. Note that in FM mode, pressing 1 will enter 10 as the digit in the frequency display. When all of the digits have been entered, the tuner will automatically tune to the displayed station frequency.

Examples:

FM87.50MHz	Press: 8 > 7 > 5 > 0
FM101.90MHz	Press: 1 > 1 > 9 > 0
AM1610kHz	Press: 1 > 6 > 1 > 0

MONO Button 23

The MONO button changes the FM mode from stereo reception to mono reception. In stereo mode, a stereo signal will be heard if the station is broadcasting a stereo signal and there is sufficient signal strength. A stereo indicator will light in the front panel display. In mono mode, a mono signal will be heard even if the station is broadcasting a stereo signal.

Note: Switching to mono mode can be a useful way to improve the reception of weak or distant FM signals. Less signal strength is required for clean mono reception than for stereo reception.

Front Panel: Configuration Controls

VIDEO LABEL Button 16

You may customize the labels of the VIDEO INPUT SOURCE buttons so that the names of your particular components are displayed in the front panel display and the on-screen display when selected. For example, you could choose to have DVD displayed in place of VIDEO 2. Labels may be up to 9 characters long. Inputs that can be relabelled are VIDEO 1, VIDEO 2, VIDEO 3, VIDEO 4, and AUX/VIDEO 5. To relabel the video inputs:

1. Select the VIDEO INPUT you wish to relabel.
2. Press and hold the VIDEO LABEL button for 3 seconds. The 9 segments of the front panel display turn to bars, each representing one available character. The first bar blinks.
3. Press the TUNING <> buttons repeatedly to step backwards or forwards through the available characters until you find the first letter or character in the desired name. Available characters include the 26 letters of the alphabet, the numbers 0 – 9, and nine special characters. When the desired character is displayed, press the MEMORY button to move to the next character in the display. The next segment in the display will blink.
4. Repeat step 3 above until you have entered all nine characters in the desired video label, including “blanks” for unused characters. As soon as you press the MEMORY button following the ninth character, the new label will be stored.

SPEAKER MODE Button 14

Home theater speaker systems vary considerably in their size and performance, particularly in their bass output. For this reason, today’s surround sound processors feature elaborate logic which can send thunderous bass information from movie soundtracks to the speaker(s) best able to handle it – subwoofers and/or large speakers. For optimum surround sound performance, it is necessary to tell the RTC-965 what speakers your system includes and what type they are.

The following configuration instructions refer to LARGE and SMALL speakers. The size refers more to the bass performance of the speaker than its physical size. A full-range speaker that has extended bass response is considered LARGE. A compact minispeaker with limited bass response or power handling is considered SMALL.

While understanding the terms LARGE and SMALL is useful, it is probably more important to understand what these different speaker types mean in terms of *system* performance. This will help determine how you should configure your system. **As a general rule, the system will redirect bass information away from SMALL speakers and send it to the LARGE speakers and/or the SUBWOOFER in your system.**

Things become a little more complex in systems with a subwoofer. **For example, the system will generally not redirect bass information away from a LARGE speaker to the subwoofer.** Thus, the decision you often need to make when faced with a choice of LARGE or SMALL is whether you want the particular speaker to play the deep bass or whether you would prefer that the deep bass be sent to the subwoofer. If you have invested in a subwoofer for your system, you might decide to send all of the bass to it, regardless of how capable the other speakers in the system may be. In this case, you would tell the RTC-965 that all of your speakers are SMALL, without regard to how big they may actually be.

An alternative configuration for setting up front SMALL speakers with a subwoofer would be to follow the speaker manufacturer's instructions, wiring the SMALL speakers to the subwoofer's crossover and then connecting the subwoofer directly to the front speaker connection terminals. In this arrangement, the speakers would be classified as LARGE and the subwoofer setting would be OFF for all surround modes. No information will be lost during playback because the system knows to redirect the bass information to the front LARGE speakers. This configuration may be optimal for many users as it can improve the way the bass integrates into the listening room and ensure correct satellite speaker operation by using the speaker manufacturer's own crossovers.

The following speaker options are available:

FRONT SPEAKERS (small/large): This menu setting determines what kind of main front left and right speakers you are using. Use the LARGE setting if your main left and right speakers are full range designs with good bass response capability. If you are using minispeakers, use the SMALL setting.

CENTER SPEAKER (small/large/none): Use the LARGE position (not available with SMALL front speakers) if your system's center channel speaker is capable of full-range, extended bass response. Use the SMALL position if your center channel speaker has more limited low frequency capability, or if you prefer that the bass be sent to the subwoofer. Select the NONE setting if your system does not have a center channel speaker.

REAR SPEAKERS (small/large/none): If your rear surround speakers are capable of sustained low frequency output, select the LARGE setting (not available with SMALL front speakers). If your rear speakers have limited bass capability or if you would prefer that the bass go to a subwoofer, use the SMALL setting. If your system has no rear surround speakers, select the NONE setting (surround information will be added to the front speakers).

SUBWOOFER (yes/no): Use the YES setting if your system has a subwoofer. If your system does not have a subwoofer, select NO.

Note 1: *Speaker configuration need only be done one time. The configuration will apply to all surround modes.*

Note 2: *The available options during the configuration procedure may vary depending on the current surround mode setting. For this reason, select one of the surround modes, either Dolby Pro Logic or Dolby Digital, before setting the speaker configuration.*

Note 3: *Dolby Digital and DTS modes are automatically activated based on software codes; there is no manual mode setting. Therefore, to use one of these modes for configuring the speaker settings, play a Dolby Digital or DTS digital recording to activate these modes and then press the SPEAKER MODE button to configure the speakers.*

There are two ways to configure your speaker system. One is the On-Screen menu system (described later in this manual). The other method uses the front panel SPEAKER MODE button:

1. Select the Dolby Pro Logic surround mode with the front panel buttons or by playing a Dolby Digital or DTS digital source.
2. Press and hold the SPEAKER MODE button for at least 2 seconds to activate the FRONT speaker configuration. An indicator will appear in the front panel display.
3. Quickly press the SPEAKER MODE button in succession to toggle through the available options for the FRONT speakers (large/small). The selection will appear on front panel display.
4. When the correct size configuration for your FRONT speakers appears, press the MEMORY button to store the setting. This will automatically take you to the configuration options for the next type of speaker, for example, the CENTER speaker.
5. Repeat steps 3 and 4, pressing the SPEAKER MODE button quickly in succession until you reach the desired setting and then confirm the selection by pressing the MEMORY button. Continue until you have set the proper configuration for all speakers.

Once complete, you can check the current settings at any time by briefly pushing the SPEAKER MODE button repeatedly to toggle through the various speaker settings.

MENU Button 13 49

Activates the On-Screen Menu system for system setup and configuration. See the section detailing the operation of the On-Screen Menu system below. Press the button to activate the menu system.

RR-939 Remote Control

The RTC-965 includes a handheld remote control that does far more than operate the RTC-965. The RR-939 is a full-function programmable remote control that can operate up to 8 audio/video components.

A separate manual, included with the remote, gives detailed information on programming and using the RR-939 to replace all of the remote controls in your system. This section is intended to provide only that information which pertains to the use of the RR-939 to operate the RTC-965.

Note: Many functions duplicate the RTC-965 front panel controls and are listed here only for your reference. Please refer to the previous Front Panel Controls section of this manual if you need additional information.

To operate the RTC-965 with the remote, make sure that the AUDIO mode is active by pressing the AUD button on the remote before you start. If it is active, pressing command keys on the RR-939 will cause the AUDIO button to flash red. Once the AUDIO mode is active, it will stay active unless you press one of the other DEVICE buttons to control a different component.

Programming the RR-939

The RR-939 is preprogrammed from the factory to operate the RTC-965. Should the AUDIO command set on your RR-939 not operate the RTC-965, it's possible that the programming has been inadvertently changed. **To reprogram the remote to operate the RTC-965 (Audio Code = 001):**

1. Press the AUDIO button at the top of the remote while simultaneously pressing the MUTE button and hold both for at least one second. The AUDIO button will light in red for 20 seconds, indicating that you have entered the program mode. The next step must be done within this 20 second period, or the RR-939 will revert to its standard operating mode.
2. Use the NUMERIC buttons to enter the 3-digit code (001) for the RTC-965 – press 0, then 0, then 1. The AUDIO button will flash each time you enter a digit.
3. Store the code number by pressing the corresponding AUDIO button again. The button will blink twice to confirm the storage of the code in memory.

POWER Button 43

Duplicates the function of the STANDBY switch on the front panel. Press to activate the RTC-965. Press again to deactivate. The main POWER button on the front panel must be in the ON position for the remote standby function to operate.

VOLUME Buttons 41

A pair of buttons which duplicate the function of the front panel volume control. Press VOLUME UP to increase the volume and press VOLUME DOWN to decrease the volume.

TUNING Button 42

A pair of buttons used to change the station frequency up or down and duplicating the front panel TUNING button.

To tune manually, press the button quickly and release to increase or decrease the station frequency to the next available setting, whether or not there is a station broadcasting on that frequency. Use a succession of quick button presses to reach the desired station.

To tune automatically, press and hold the TUNING button for approximately one second. The tuner will begin automatically scanning up or down until the next available station is detected. Weak stations will be skipped during auto tuning.

INPUT SOURCE Buttons 48

Two rows of buttons duplicate the function of the ten INPUT SOURCE buttons on the front panel. Select an input source by pressing the appropriate button. The AUX 1 and AUX 2 buttons correspond to the front panel VIDEO 4 and VIDEO 5 buttons.

5.1 Button 51

Duplicates the 5.1 CH button on the front panel. Selects the 5.1 Channel input, overriding any other source selection.

BAND Button 45

Duplicates the AM/FM button on the front panel. Toggles between AM and FM modes.

NUMERIC Buttons 47

Ten numeric buttons, labeled 0 through 9, duplicate the function of the NUMERIC keypad on the front panel. Selects memorized station presets.

DYNAMIC Button 54

Duplicates the DYNAMIC RANGE button on the front panel. Selects of three available dynamic range settings.

MUTE Button (remote only) 44

Push this button once to reduce all output levels to 0 – in other words, to turn the sound off. A flashing mute indication will appear in the front panel and on screen displays. Press the MUTE button again to restore previous volume levels.

MENU button 49

Duplicates the function of the front panel MENU button. Push this button to turn on the on-screen menu system. If the menu system is already visible, push this button to cancel the Display.

Note: The RTC-965 On-Screen Display will automatically be turned off following 20 seconds without any control activity.

..... Rear Panel Connections: Overview

The RTC-965 provides rear panel connections for five video sources, three audio sources, and a phono input for use with a turntable. These connections include standard RCA audio inputs and outputs, composite video inputs and outputs, S-Video inputs and outputs, plus digital inputs (coaxial/RCA jack and optical).

The RTC-965 includes a full complement of RCA preamp outputs for use with external amplifiers. In addition, a pair of video output (composite and S-Video) connect the unit to your TV monitor.

The RTC-965 also includes 25-pin 5.1 channel input and output connections, a remote IR sensor connection, and antenna connections.

Note: *DO NOT plug any system component into an AC source until system hookup is complete and you are confident that all component-to-component connections have been properly made.*

All video cables should have a 75 ohm impedance rating. Although conventional audio interconnects will pass a video signal, their construction and limited bandwidth impose a performance penalty because, in part, they do not adhere to the 75 ohm standard. The S/PDIF digital audio interface standard specifies a 75 ohm transmission line and all good digital cables adhere to this requirement. Because the video and S/PDIF standards are so close, you can use a video cable for digital audio data transmission. We strongly advise that you NOT substitute a conventional analog audio interconnect cable for either digital or video.

When making signal connections, make sure that you always preserve proper channel consistency, i.e. connect LEFT channels to LEFT channel jacks and RIGHT channels to RIGHT channel jacks. All RCA-type connections on the RTC-965 follow these standard color codes:

- Left channel audio* = RCA jack with white inset
- Right channel audio* = RCA jack with red inset
- Composite video* = RCA jack with yellow inset

Rear Panel: Audio Source Connections

Connect your audio-only source components to these RCA inputs and outputs:

Phono Inputs 30 and Phono Ground 29

Connect the left and right output cables of a turntable to this pair of RCA inputs. Connect the ground wire from your turntable to the phono ground lug, labeled GRD.

CD Inputs 31

Connect the left and right analog outputs from a CD player to the RCA input jacks labeled CD.

Tape Inputs and Outputs 38

The RTC-965 provides two sets of audio tape deck connections labeled TAPE 1 and TAPE 2. Each set has a pair of inputs and a pair of record outputs that allow you to record on either tape deck.

Connect the left and right analog outputs from an audio tape deck to the TAPE 1 IN input jacks. Connect the TAPE 1 OUT output jacks to the INPUTS on the audio tape deck.

Connect a second tape deck to the TAPE 2 connections – the outputs of the tape deck to the IN jacks on the RTC-965 and the OUT jacks on the RTC-965 to the inputs on the second tape deck.

Rear Panel: Video Source Connections

There are groups of connections for up to five video source components. Each group includes a pair of RCA analog audio inputs, a composite video input, and an alternative S-Video input. One group, VIDEO 1, also includes a set of record outputs (in the same formats) for sending audio and video signals to a VCR.

VIDEO 1 Inputs/Outputs 32

Connect your VCR to the VIDEO 1 group of inputs and outputs. This set of connections allows recording.

Connect the analog audio **outputs** of the VCR to the VIDEO 1 PLAY left and right RCA audio jacks. Connect the VIDEO 1 REC left and right RCA audio output jacks to the analog audio line **inputs** on the VCR.

If you have decided to use composite video connections in your system, connect the RCA composite video **output** of the VCR to the RCA composite video **input** labeled VIDEO 1 PLAY. If you prefer to use S-Video connections, connect the S-Video **output** of the VCR to the VIDEO 1 PLAY S-Video **input**.

Hookup the VIDEO 1 REC video output (either RCA composite or S-Video) to the video line recording input on your VCR.

VIDEO 2 – 5 Inputs 32

These four sets of audio/video inputs allow connection of four additional video components such as a play-only VCR, DVD player, LaserDisc player, or DSS satellite receiver.

Connect the RCA analog audio outputs of the first video component to the left and right RCA analog audio inputs labeled VIDEO 2. Then, connect either the RCA composite video or S-Video output of the video source to the corresponding RCA composite or S-Video connection labeled VIDEO 2.

Repeat for additional video components, using VIDEO 3, VIDEO 4, and AUX./VIDEO 5.

Note: *Any of the video source inputs may also be used for an audio-only source. Simply omit the video connection.*

Digital Inputs 37

The RTC-965 features a complete D/A conversion capability which accepts digital input signals from source components such as CD players, satellite TV receivers, and 5.1 channel Dolby Digital or DTS signals from DVD and Laser Disc players. The D/A automatically senses and adjusts to the correct sampling rates.

These digital inputs are available for VIDEO 2 (coaxial), VIDEO 3 (coaxial), VIDEO 4 (optical), and AUX/VIDEO 5 (optical).

To use the digital inputs, connect the appropriate cable (optical or coaxial) from the digital output of your source component to the corresponding DIGITAL INPUT on the RTC-965. Make sure that if you have connected the analog signals from a source to VIDEO 2, that you also connect its digital output to VIDEO 2, etc.

Even when using digital connections, you should still make the analog input connections described above. The analog connection is necessary should you wish to record from that source component to an audio tape deck or VCR.

5.1 Channel Audio Input 36

This female DB25 25-pin input connects six discrete channels of analog information from an outboard processor in a single cable.

Many external adaptors provide a choice of RCA or DB25 outputs. We suggest that you use a DB25-to-DB25 cable to reduce the number of cables and to insure proper channel-to-channel continuity. If your external adaptor does not have a DB25 output, you will need to purchase a multi-RCA to DB25 adaptor cable from your authorized Rotel dealer. Make sure to observe proper channel continuity. **See Figure 4 for DB25 pin assignments.**

Rear Panel Output Signal Connections

This section of the manual provides complete information on the audio and video signal output connections on the rear panel of the RTC-965. These are used for routing the output signals to television monitors, audio amplifiers, and recording devices. For convenience, each topic begins with an overview of the particular connection, followed by detailed hookup instructions.

TV Monitor Output 39

The video output of the RTC-965 sends the video signal to your TV monitor. Both RCA composite and S-Video connectors are provided. Simply connect the TV MONITOR output, either RCA composite or S-Video, to an input on your television monitor. Whatever input source is selected on the RTC-965 will appear on screen.

RCA Preamp Outputs 27

The RTC-965 provides a set of RCA preamp audio outputs: one for a powered subwoofer and five more (FRONT LEFT/FRONT RIGHT/CENTER/RIGHT REAR/LEFT REAR) that allow you to use external amplifiers in place of one or more of the built-in amps.

To hook up a powered subwoofer, connect a standard RCA audio cable from the SUBWOOFER OUTPUT jack to the input on the subwoofer's power amp.

To hook up the RCA main audio outputs, connect a standard audio cable from each output to the input of the amplifier channel that will power the corresponding speaker. In a full home theater system using external amplifiers for all channels, you will need to make six different connections corresponding to the six speakers (left front, center front, right front, left surround, right surround, and subwoofer).

It is important to make sure that you have the correct output connected to the proper amplifier channel (front right, left rear, etc.). Take your time.

5.1 CHANNEL Preamp Outputs 28

As an alternative to the RCA preamp outputs, the RTC-965 also provides a male DB25 multi-pin output connector which carries all six output channels in a single cable. The DB25 output connector provides exactly the same signal as the RCA outputs, but is more convenient for use with Rotel, or other, multichannel amplifiers equipped with a matching DB25 input. Choose whichever is most convenient for your system hookup.

To use the DB25 output connections, simply connect a female-to-male DB25 audio cable from the output of the RTC-965 to the matching input on the multichannel power amplifier. **See Figure 4 at the front of this manual for DB25 pin assignments.**

Rear Panel Antenna Connections

The RTC-965 requires two antennas to receive radio signals, one for AM and one for FM (MW and LW in some countries). Most users will get acceptable reception using the indoor antennas which are supplied with the RTC-965. Instructions for hooking up these antennas follow.

Note: *If you are located a considerable distance from the radio transmitters, you may choose to use outdoor antennas to improve reception. Outdoor antenna systems can be dangerous if they are not properly grounded and should always be installed by a professional contractor familiar with the electrical code requirements in your local area.*

AM Loop Antenna 26

The RTC-965 includes a loop antenna to receive AM radio signals. Remove this antenna from the box and locate it near the RTC-965.

Connect the 300 ohm twin-conductor wire from the loop antenna to the pair of screw terminals labeled AM LOOP, attaching one wire to each terminal. It does not matter which wire attaches to which terminal, but make sure that the connections are solid and that the two wires do not touch.

You may need to rotate or otherwise reorient the antenna to find the best position.

Note: To use an outdoor antenna, connect its 300 ohm twin-conductor wire to the G and AM terminals in place of the loop antenna, only after a professional contractor has installed the antenna system in accordance with local electrical codes.

FM Wire Antenna 35

The RTC-965 includes a wire antenna to receive FM signals. In many countries (including the USA), this antenna is a T-shaped twin-conductor 300Ω antenna. Remove this antenna from the box and connect its two conductors to the two screw terminals on the supplied 300Ω to 75Ω adaptor. Connect the coax plug on the converter to the FM 75Ω antenna connector on the RTC-965.

For best reception, unfold the T-shaped wire antenna. There are eyelets at both ends of the T, which allow tacking the antenna to a wall, if desired. Experiment with positioning for best reception.

In some countries, the RTC-965 may be supplied with a single wire FM antenna terminated by a 75Ω coax connector. If your unit is supplied with this antenna, connect it directly to the FM 75Ω antenna connector.

Note: To use an outdoor antenna, connect its 75 ohm coax lead wire (or 300 ohm twin-conductor wire and 300 ohm to 75 ohm adaptor) to the FM 75Ω connector in place of the indoor wire antenna, only after a professional contractor has installed the antenna system in accordance with local electrical codes.

Rear Panel AC Power Connections

AC Input 40

Your RTC-965 is configured at the factory for the proper AC line voltage in the country where you purchased it (either 115 volts AC or 230 volts AC with a line frequency of either 50 Hz or 60 Hz). The AC line configuration is noted on a decal on the back of your unit.

Plug the supplied cord into the AC INPUT receptacle on the back of the unit.

AC Convenience Outlets 33

Two outlets let you plug AC cords from source components or other accessories into the back of the RTC-965 so that they will be turned on and off automatically. The outlets are powered whenever the RTC-965 is fully active. They are off when the RTC-965 is in STANDBY mode.

Note: The rear panel AC outlets are only available on 115 Volt versions of the RTC-965 and not available on 230 Volt models.

Remote External Sensor Jack 34

This 3.5 mm mini-jack receives command codes from industry-standard infrared receivers (Xantech, etc.) via hard-wired connections. This feature could prove useful when the unit is installed in a cabinet and the front-panel sensor is blocked. Consult your authorized Rotel dealer for information on these external repeaters and the proper wiring of a jack to fit the mini-jack receptacle.

On-Screen Display / Configuration

The RTC-965 features two on-screen systems to help operate the system. The first consists of simple status displays that appear on the TV screen whenever primary settings (Volume, Input, etc.) are changed. These status displays are self-explanatory.

A more comprehensive On-Screen Menu system is available at any time by pressing the MENU button on the front panel or the remote control. This system includes intuitive menus that guide you through the setup and operation of virtually every function and setting of your RTC-965.

Navigation Buttons 41 46 49 50 52 53

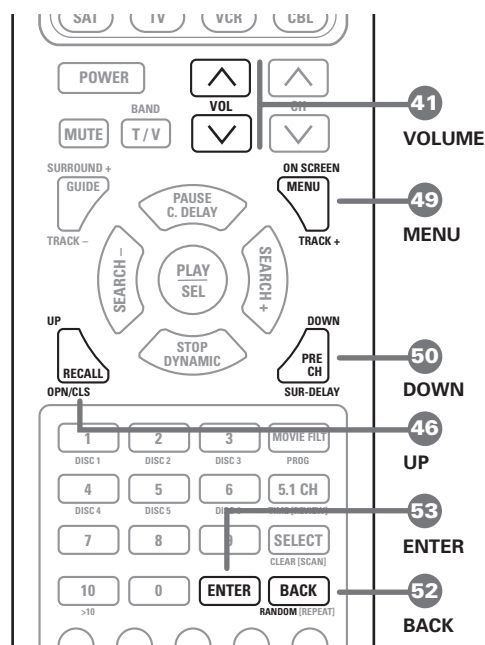

The following buttons are used to navigate the On-Screen Menu system:

MENU Button: 49 To display the MAIN screen. All other menus are reached from this menu. If a menu is already visible, push this button to cancel the Display.

DOWN/UP remote control buttons 50 46 or NUMERIC Keypad front panel buttons (▲▼) 5: To move up and down in the lists that appear on the On Screen Menu system.

VOLUME DOWN/UP remote control Buttons: 41 To change the current settings for a selected menu choice on some menus in the On-Screen Menu system.

ENTER Button: 53 To toggle through available settings for a selected menu choice on some menus.

BACK Button: 52 The BACK button is used to cancel a selection on an On Screen Menu and return to the previous menu.

Note: There is no need to memorize these buttons. A brief help system at the bottom of each On-Screen Menu reminds you which buttons to press. All screens disappear automatically following 20 seconds of inactivity.

Figure 7 at the front of this manual shows the menus that constitute the On-Screen Menu system and how to reach them. Most of the menus are used to configure the system and will not typically be used during normal operation. Details of each menu follow:

MAIN Menu

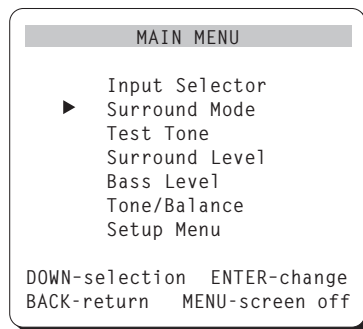

The MAIN menu provides a starting point for reaching all other screens and menus. This screen is available at any time by pressing the MENU button on the remote control or the front panel. To go to another menu, move the cursor to the desired line using the UP/DOWN buttons on the remote or the NUMERIC Keypad front panel buttons (▲▼) and confirm the selection by pressing the ENTER button. The screen disappears automatically after 20 seconds of inactivity or by pressing the BACK or ENTER button.

INPUT SELECTOR Menu

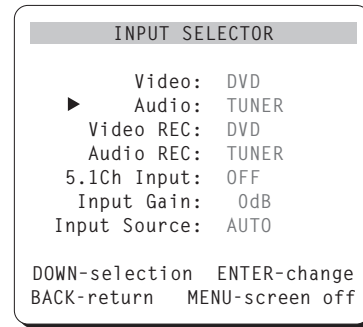

The INPUT SELECTOR menu provides status information and configuration options for the source inputs. This screen is available from the MAIN menu. The screen displays the following status information:

VIDEO: the currently selected video source

AUDIO: the currently selected audio source

VIDEO REC: the currently selected source for VIDEO 1 REC outputs

AUDIO REC: the currently selected source for audio recording, cannot be independently changed

INPUT GAIN: the gain setting of the current audio source. Adjust this if the source is noticeable louder or quieter than the other sources.

5.1 CH INPUT: whether or not the 5.1 channel input is active

INPUT SOURCE: AUTO or ANALOG. With the AUTO setting (the factory default), the selected input source will check first to see if there is a signal present at the digital inputs. If so, it will play the digital signal, automatically activating DOLBY DIGITAL or DTS surround processing depending on the source. If no digital signal is present, the analog inputs will be automatically enabled for that source. With the ANALOG setting, the automatic sensing is disabled and the system will always revert to the analog inputs. A digital signal will be ignored even if present and there will be no DOLBY DIGITAL or DTS processing. Generally, this setting should be left in the default AUTO mode unless you wish to override the digital inputs for some reason.

Change any setting by moving the cursor to the desired line using the UP/DOWN buttons on the remote or the NUMERIC Keypad front panel buttons (▲▼), adjust the setting using the ENTER buttons. Return to the MAIN menu by pressing the BACK button. Turn off the On-Screen Display by pressing MENU.

SURROUND MODE Menu

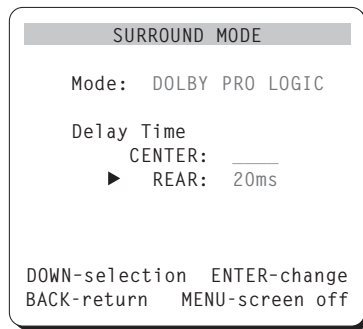

The SURROUND MODE menu provides status information and configuration options pertaining to the surround operation. This screen is available from the MAIN menu. The screen displays the following status information:

MODE: the currently selected surround sound mode (PRO LOGIC, DSP, 3-STEREO, etc.) Remember that Dolby Digital and DTS are automatically enabled based on source material encoding and, therefore, no setting is required.

DELAY TIME (center): the current delay setting for the center channel speaker; only available in Dolby Digital mode

DELAY TIME (rear): the current delay setting for the rear surround speakers

In many systems, the factory delay settings will be satisfactory. However, delay times may need to be adjusted depending on the relative distance from the listening position to the front and rear speakers so that you do not hear, for example, an explosion in a soundtrack start in the rear of the room instead of the front. Increase the relative delay to the rear speakers if they are located closer to the seating area than the front speakers.

Change a setting by moving the cursor to the desired line using the UP/DOWN buttons on the remote or the NUMERIC Keypad front panel buttons (▲▼), adjust the setting using the ENTER remote button. Return to the MAIN menu by pressing the BACK button. Cancel the On-Screen Display by pressing the MENU button.

TEST TONE Menu

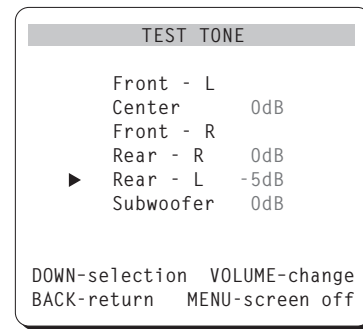

This menu is used to set equal volume levels for all speakers (front, center, rear, and subwoofer) for proper Dolby Digital and DTS reproduction. For best results, you should perform the test tone calibration in DOLBY DIGITAL surround mode. To do this, you will need to play a Dolby Digital source so that the RTC-965 can automatically sense it and activate the DOLBY DIGITAL mode. Then, enter the On-Screen Menu system and select TEST TONE from the MAIN menu to reach this screen. If you adjust this menu while in PRO LOGIC mode, only one of the rear adjustments will be available as the two rear speakers share a common signal in PRO LOGIC mode.

When you enter the TEST TONE menu, you will hear a test tone coming from the highlighted speaker. Highlight different speakers by moving the cursor to the desired line using the UP/DOWN buttons on the remote or the NUMERIC Keypad front panel buttons (▲▼). The test tone will shift accordingly to the selected speaker.

While seated in the normal listening location, switch the test tone to the various speakers. Using the front speakers as a fixed reference (there is no adjustment for the front), listen to hear if the center speaker or the rear speakers are noticeably louder or quieter than the front speakers. If so, adjust the speaker's volume levels up or down to match the front speakers using the VOL UP/DOWN remote buttons. Continue switching among the speakers and adjusting until the center speaker and both of the rear speakers sound as loud as the front speakers.

Return to the MAIN menu by pressing the BACK button. Cancel the On-Screen Display by pressing MENU.

Note to Perfectionists: This calibration will be more accurate if you use a sound pressure level (SPL) meter to measure the output of each speaker instead of relying on your ear. SPL meters are available from electronics stores, or your authorized Rotel dealer may loan you one. Set the meter to its SLOW response time with C-weighting and be sure to hold it away from your body. The goal is to adjust each speaker so that the meter provides the same reading for each of the speakers in your system.

SURROUND LEVEL Menu

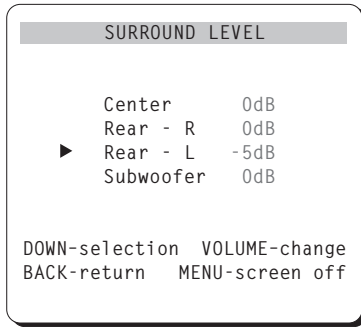

This menu adjusts the relative volume level of the center speaker, rear speakers, and subwoofer. It differs from the previous TEST TONE menu in that it does not use a test tone for adjustment.

Cycle through the speakers by moving the cursor to the desired line using the UP/DOWN buttons on the remote or the NUMERIC Keypad front panel buttons (▲▼), adjusting volume levels up or down using the VOL UP/DOWN remote buttons. Return to the MAIN menu by pressing the BACK button. Cancel the On-Screen Display by pressing MENU.

BASS LEVEL Menu

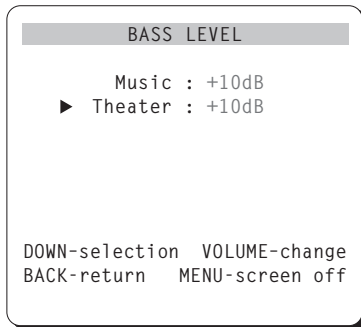

This menu provides a way to adjust and store different overall bass output settings, one for music surround modes and one for theater surround modes. Unlike the front panel bass control, these settings are intended to be permanent and engaged automatically each time a music or theater surround mode is selected.

Highlight the desired line of the menu using the UP/DOWN buttons on the remote or the NUMERIC Keypad front panel buttons (▲▼). Use the VOL UP/DOWN remote buttons to adjust the setting. Return to the MAIN menu by pressing the BACK button. Cancel the On-Screen Display by pressing MENU.

TONE/BALANCE Menu

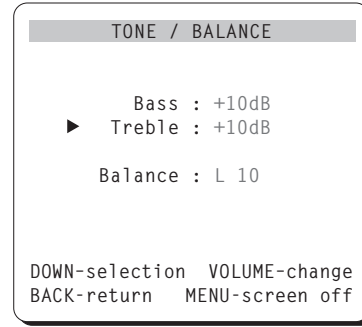

This menu duplicates the functions of the front panel TREBLE, BASS, and BALANCE controls and provides a method of changing them with the remote control. Select a line in the menu using the UP/DOWN buttons on the remote or the NUMERIC Keypad front panel buttons (▲▼), then adjust the setting using the VOL UP/DOWN remote buttons. Return to the MAIN menu by pressing the BACK button. Cancel the On-Screen Display by pressing MENU.

SETUP Menu

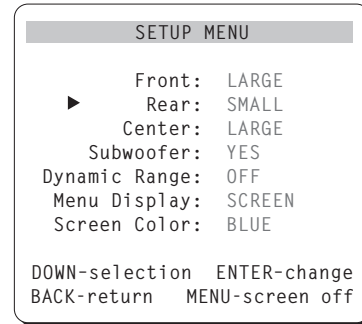

The SETUP menu provides status information and configuration options for a variety of system parameters. Some of these settings duplicate the function of front panel controls.

Note 1: See the discussion of speaker configuration under the **SPEAKER MODE** button heading in the **Front Panel Controls** section of the manual. Detailed instructions for choosing speaker types are presented there.

Note 2: Speaker configuration must be performed for each surround mode.

Note 3: Some options described below will not be available in some surround modes and some system configurations.

FRONT: whether the front speakers are LARGE (full bass response) or SMALL (limited bass output)

REAR: whether the rear speakers are LARGE, SMALL, or NONE

CENTER: whether the center speaker is LARGE, SMALL, or NONE

SUBWOOFER: whether there is a subwoofer in the system: YES or NO

DYNAMIC RANGE: whether the dynamic range compression is turned OFF (full dynamic range/no compression), MID (moderate dynamic range/moderate compression), or MIN (minimum dynamic range/maximum compression)

MENU DISPLAY: determines whether status information will appear on screen when volume, input, or other selections are made – choices are SCREEN (display on) or OFF (display off).

SCREEN COLOR: selects a background color for the on screen display.

Change any setting by moving the cursor to the desired line using the UP/DOWN buttons on the remote or the NUMERIC Keypad front panel buttons (▲▼), change the setting by pressing the ENTER button to step through the choices. Return to the MAIN menu by pressing the BACK button. Cancel the On-Screen Display by pressing MENU.

RTC-965 Specifications

Audio

Total Harmonic Distortion:	<0.03%
Intermodulation Distortion (60 Hz: 7 kHz):	<0.03%
Frequency Response (line level):	10 Hz - 70 kHz, ±3 dB
Signal to Noise Ratio (IHF "A" weighted):	92 dB (Stereo) 70 dB (Dolby Digital)
Input Sensitivity/Impedance	
Line Level:	200 mV/47 kohms
Phono Input:	3.5 mV/47 kohms
Tone Controls (Bass/Treble):	±8 dB at 100 Hz/10 kHz

Video

Frequency Response:	3 Hz-10 MHz, ±3 dB
Signal to Noise Ratio:	45 dB
Input Impedance:	75 ohms
Output Impedance:	75 ohms
Output Level:	1 volt

FM Tuner

Usable Sensitivity:	14.2 dBf
Signal to Noise Ratio:	70 dBf
Harmonic Distortion:	0.3%
Stereo Separation (1 kHz):	45 dB
Output Level (mono):	550 mV, ±100 mV
Antenna Input:	75 ohms unbalanced

AM Tuner

Sensitivity:	500 µV/m
Signal to Noise Ratio:	40 dBf
Output Level:	150 mV, ±30 mV
Antenna Input:	Loop Antenna

General

Power Consumption:	40 watts
Power Requirements (AC):	115 volts 50/60 Hz or 230 volts 50/60 Hz
Weight:	6.9 Kg/15.2 lb.
Dimensions (W x H x D):	450 x 158 x 303 mm 17 ³ / ₄ " x 6 ¹ / ₄ " x 12"

All specifications are accurate at the time of printing.

Rotel reserves the right to make improvements without notice.

Rotel and the Rotel HiFi logo are registered trademarks of The Rotel Co, Ltd., Tokyo, Japan.

DTS is a registered trademark of Digital Theater Systems.

Manufactured under license from Dolby Laboratories Licensing Corporation. "Dolby", "Pro Logic", and the double-D symbol are trademarks of Dolby Laboratories Licensing Corporation. Confidential unpublished works © 1992 – 1997 Dolby Laboratories, Inc. All rights reserved.

RTC-965

SURROUND SOUND TUNER PREAMPLIFIER

The Rotel Co. Ltd.

10-10 Shinsen-Cho
Shibuya-Ku
Tokyo 150-0045
Japan
Phone: +81 3-5458-5325
Fax: +81 3-5458-5310

Rotel of America

54 Concord Street
North Reading, MA 01864-2699
USA
Phone: +1 978-664-3820
Fax: +1 978-664-4109

Rotel Europe

Meadow Road
Worthing, West Sussex BN11 2RX
England
Phone: +44 (0)1903 524 813
Fax: +44 (0)1903 524 831

Rotel Deutschland

Kleine Heide 12
D-33790 Halle/Westf.
Germany
Phone: +49 05201-87170
Fax: +49 05201-73370

ROTEL*hi-fi*

ROTEL*hi-fi*

ROTEL*hi-fi*

ROTEL*hi-fi*

ROTEL*hi-fi*

ROTEL*hi-fi*

ROTEL*hi-fi*

ROTEL*hi-fi*

ROTEL*hi-fi*

ROTEL*hi-fi*

ROTEL*hi-fi*

ROTEL*hi-fi*

ROTEL*hi-fi*

ROTEL*hi-fi*

ROTEL*hi-fi*

ROTEL*hi-fi*

ROTEL*hi-fi*

ROTEL*hi-fi*

ROTEL*hi-fi*

ROTEL*hi-fi*