



Prestigio

10 YEARS IN THE ART OF HI-TECH



MultiPad 7.0 ULTRA+

PMP3570C

Tablet PC

User Manual

www.prestigio.com

Common information

Dear Customer,

Thank you for choosing Prestigio MultiPad 7.0 ULTRA+ (PMP3570C) Tablet PC. Before starting to use the tablet, please read this manual carefully to discover all its features. Please save this manual and refer to it in the future if you have questions concerning your device.

This manual contains safety information, technical specifications of Prestigio MultiPad 7.0 ULTRA+ (PMP3570C) Tablet PC, preinstalled software basic features, setup and other useful information, which will help you to improve your use of the device, Android operating system and applications.

For information about meaning of the terms used in this manual, please refer to the "Glossary" section at the end of this manual, as well as to other open information sources or Prestigio customer support line.

Disclaimer

As the Prestigio products are constantly updated and improved, your device's software may have a slightly different appearance or modified functionality than presented in this User Manual. We make every effort to ensure that the information and procedures in this user manual are accurate and complete. No liability can and will be accepted for any errors or omissions. Prestigio reserves the right to make any changes without further notice to any products herein.

Important Safety Instructions

Your Prestigio MultiPad 7.0 ULTRA+ (PMP3570C) Tablet PC is manufactured and designed for mobile usage. Please read the following instructions carefully. It helps you to use your device without safety issues and keep your Tablet PC in good working condition:

1. Do not place objects on top of the MultiPad as objects may scratch the screen.
2. MultiPad should be kept away from extreme changes of temperature.
3. Protect it from direct sunlight or heat sources.
4. Protect the device from moisture and from dusty or smoky environment as it can harm the tablet.
5. Keep your MultiPad away from contact with active chemicals.
6. Do not place the MultiPad on an uneven or unstable surface. Fall of the device can cause damage to the LCD screen which is not covered with warranty.
7. Do not expose the MultiPad to strong magnetic or electrical field.
8. Protect your MultiPad from hits and extreme pressure.
9. Operation Temperature: This MultiPad should only be used in environments with ambient temperatures between 0°C (32°F) and 50°C (122°F).
10. Do not insert into MultiPad devices or items not matching to standard sockets on it.
11. Do not use MultiPad in the rain - it is NOT a waterproof device. Protect the Multipad from dust, dirt and high humidity.
12. Do not use Your MultiPad during driving.
13. Use only manufacturer approved chargers. Using non-original chargers may cause damage of the device and be harmful to your health.
14. The MultiPad and the adapter may produce some heat during normal operation or charging. Avoid placing it to the soft surfaces, other places and conditions which may prevent normal dispersion of the heat, causing device overheating. Do not leave the MultiPad on your lap or other part of the body to prevent discomfort or injury from heat exposure.
15. Disconnect the MultiPad from an electrical outlet after it is charged.
16. Do not use a pen or any sharp object to tap the screen. Clean the touch screen with a soft cloth. If needed, dampen the cloth slightly before cleaning. Never use abrasives or cleaning solutions.
17. DO NOT disassemble the MultiPad, only a Prestigio certified service technician should perform repair.
18. Always power off the MultiPad to install or remove external devices that does not support hot-plug.
29. Your MultiPad must be switched off during airplane take-off and landing.

Warranty Information

Warranty information could be found at www.prestigio.com/service. Prestigio MultiPad MultiPad 7.0 ULTRA+ (PMP3570C) Tablet PC life cycle is 2 years.

Contents

1. Product Overview

- 1.1 Package Contents
- 1.2 Device Overview

2. Getting Started

- 2.1 Charging the battery
- 2.2 Using the storage card
- 2.3 Hot plug of storage card
- 2.4 Memory space
- 2.5 Power on/off and Device Reset
- 2.6 Startup Wizard

3. Home Screen

- 3.1 Status and notifications
- 3.2 Shortcuts to Add widgets
- 3.3 Finger gestures
- 3.4 Coping files to and from the storage card
- 3.5 Searching the device and the web

4. Personalizing

- 4.1 Change the Notification ringtone
- 4.2 Change your wallpaper
- 4.3 Personalize your Home screen with folders
- 4.4 Rearrange widgets and shortcuts on your Home screen

5. Web browsing

6. Manage Applications

7. Typical applications

- 7.1 Music Player
- 7.2 Video Player
- 7.3 Gallery
- 7.4 File Manager
- 7.5 Instant Messaging tools
- 7.6 E-mails
- 7.7 Camera

8. Prestigio preinstalled applications

9. Settings

- 9.1 Wireless & networks
- 9.2 Sound
- 9.3 Display
- 9.4 Storage
- 9.5 Apps
- 9.6 Accounts & Sync
- 9.7 Location service
- 9.8 Security settings
- 9.9 Language & input setting
- 9.10 Backup & reset
- 9.11 Date & Time setting
- 9.12 Accessibility
- 9.13 Developer options
- 9.14 About tablet

10. Troubleshooting

- 10.1 Force shutdown
- 10.2 Restore default settings
- 10.3 System updating

11. Glossary

Appendix. eReader Prestigio Manual

1. Product Overview

1.1 Package Content:

Prestigio MultiPad 7.0 ULTRA+ (PMP3570C)

Tablet PC – 1x

OTG Cable – 1x

USB Cable – 1x

Power Adapter – 1x

Quick Start Guide – 1x

Legal and Safety Notices – 1x

Warranty Card – 1x

1.2 Device Overview

Control Buttons and Connectivity:

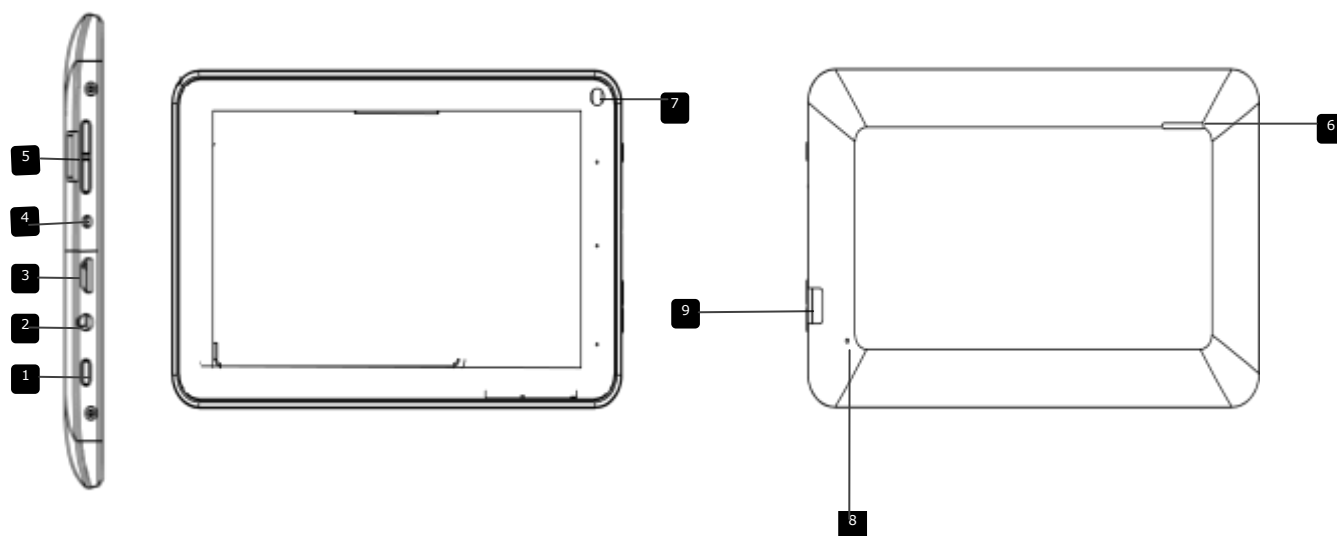

| | | |
|---|----------------------------|--|
| 1 | Power Button | Turn on/off the device; Suspend/Activate the device |
| 2 | Earphone Jack | Earphones connection |
| 3 | USB port | USB connection |
| 4 | DC port | AC adapter connection |
| 5 | Vol +\ Vol - Button | Adjust the volume level. |

| | | |
|---|---------------------------|--|
| 6 | Speaker | Emit sound, voice or music |
| 7 | Camera | Take photos. |
| 8 | Reset | Reset the device if it fails to operate correctly |
| 9 | Micro SD Card Slot | Insert Micro SD card. |

Technical Specifications:

| Processor | |
|---------------------------------|--|
| CPU | High performance ARM Cortex A8 |
| CPU Internal Clock Rate | 1.0 GHz |
| Display | |
| Display Size | 7.0 inches |
| Display Resolution | 800 x 480 pixels |
| Display Technology | TFT LCD |
| Display Features | Capacitive multi touch screen |
| Screen rotation | 4 way G-Sensor |
| Memory | |
| Internal Memory Size | 8 GB |
| Installed RAM Storage Capacity | 512 MB DDR3 |
| Flash Card | Supported Micro SD/Micro SDHC Card up to 32GB |
| Interfaces | |
| Interface ports available | Micro SD, Micro SDHC, Micro USB 2.0 |
| Interface Wi-Fi | IEEE 802.11b/g/n |
| Interface Bluetooth | No |
| Interface USB | 1 x micro USB |
| Interface Audio | 1 x 3.5 mm mini jack |
| Multimedia | |
| Digital Camera | Front : 0.3 Mpix |
| Supported eBook Formats | PDB, RTF, EPUB, PDF, TXT, FB2 |
| Supported Audio Formats | FLAC, WMA, AAC, AMR, OGG, MP2, WAV, APE, M4A, MID, MP3 |
| Supported Picture Formats | GIF, JPG, PNG, BMP |
| Supported Video Formats | AVI, WMV, MP4, MPG, MOV, M-JPEG, 3GP, RM, RMVB, MKV, FLV, VOB, M2TS, TP, TS |
| Video Features | FullHD Video Playback |
| Sound Features | Stereo Audio Playback |
| Software | |
| Operating System | Android 4.0.4 (upgradable) |
| Battery | |
| Battery Technology | Lithium Polymer |
| Battery Current Capacity | 3200 mAh |
| Battery Video playback Time | Up to 5hr |
| Battery Audio playback Time | Up to 18hr |
| Battery Standby Time | Up to 120hr |
| Miscellaneous | |
| Built-in Devices | Card Reader, Microphone, Speakers |
| Included Accessories | USB Cable, Power Adapter, Quick Start guide, OTG-cable |
| System Requirements | Linux 2.4.0 or Later, Microsoft Windows 2000, Microsoft Windows XP, Microsoft Windows Vista, Microsoft Windows 7, Apple Mac OS X 10.4 or Later |
| Applications Installed | Google Play, Browser, Explorer, Calendar, Free Note, Stock Alert, Barcode Scanner, eBook, Music, Gallery, Calculator, Blue, Facebook, Twitter, YouTube, Camera, eReader Prestigio, SugarSync, OTA updates, Video |
| Warranty | |
| Warranty Term (month) | 24 month |
| Temperature and Humidity | |
| Storage Temperature | 0°C (32°F) ~ +45°C (113°F) |
| Operation Temperature | 0°C (32°F) ~ +45°C (113°F) |
| Storage Relative Humidity | 20% ~ 90%, Non-Condensed |
| Operating Relative Humidity | 20% ~ 90%, Non-Condensed |

2. Getting Started

2

2.1 Charging the battery

Prestigio MultiPad comes with a built-in Lithium Polymer rechargeable battery and is designed to use only manufacture-specified original batteries and accessories. You can see battery status on status bar of MultiPad in the lower right corner of the home screen. Android OS has battery charge detection system and notify user if battery charge is low and device need to be connected to AC adapter. If you will see such message, or your device couldn't power on, connect original AC power adapter to charge your device. Plug one end of the adapter into the power jack of the device, and the other to the power socket. To extend the battery operation life, wait for finish of charge process.

Please, fully charge your new device after unpacking.

[Note]: it is normal if the device is warm or hot during charging, you can use it as usual, just follow the respective security precautions.

Please be informed, that Lithium Polymer is considered to be a consumable part of your MultiPad, it's rated capacity might fall up to 50% during first two years from the date of purchase; such reduction of capacity is not a defect and is not covered with warranty.

2.2 Using the storage card

Your new Prestigio MultiPad 7.0 ULTRA+ (PMP3570C) Tablet PC is equipped with Micro SD card slot to extend available device memory. It is compatible with Micro SD/ Micro SDHC/ TF-Flash card formats of size up to 32Gb. Proper functioning of larger capacity cards is not guaranteed.

Insert the storage card

The storage card slot is on the top side of the back panel of device. To insert a card, place the card into the slot and press it until click. Card must be inserted effortlessly. DO NOT push the card too strong, this could damage the card slot or storage card.

Browse files in the storage card

To browse the files you should do one of the following:

- Select “**Explorer**” icon to view files in the storage card;
- You can also install and run any other third party file browser applications.

Remove the storage card

To avoid data loss or damage, please stop using files/programs in the storage card, and then tap **Settings> Storage> Unmount SD card** to remove it safely.

To remove the storage card, gently press the edge of the card to release the safety lock and pull the card out of the slot.

[Note]:

1. Make sure the location and direction of the storage card is correct when inserting.
2. To avoid possible issues or incompatibility of the storage card with your MultiPad, major brands of

storage card are recommended. Never use damaged or cracked storage cards as this might damage the MultiPad or cause loss of your data.

2.3 Hot plug of storage card

Please do not hot plug the storage card when using or browsing its files.

For example, when you are running the Music/Video Player/ Gallery, the storage card could be damaged and files on it might become corrupt if you take out the storage card without proper preparation. As for details of inserting/removing storage card, see **2.2 Use the storage card**.

2.4 Memory space

The capacity of built-in flash chip is 8GB. The device contains 2 memory partitions: Internal storage & NAND Flash storage. The space is partitioned to store apps, setting and user data. A part of storage will be reserved for system resources and wouldn't be available for user. The exact size of available memory may vary depending on Firmware version.

MultiPad supports extended storage – micro SD cards of 32GB maximum capacity.

2.5 Power on/off and Device Reset

1. **Power on:** press down the Power Button and hold it for a while to turn on the device when the battery is full enough.
2. **Power off:** press down the Power Button and hold it for about 3 seconds and then select **Power Off** in popup menu to turn off the device.
3. **Screen Lock:** short-press down the Power Button once to shut down the screen to save battery life. Short-press down the Power Button again to activate the lock screen. After unlocking, the device will resume the screen before locking.
4. **Reset:** Use a paper clip to press the reset button (marked as “reset” on a back side of the MultiPad, close to micro SD). Press the power button for about 8 seconds to perform forced reset of device.

2.6 Startup Wizard

Prestigio Startup Wizard will guide you through the initial setup of your MultiPad. It appears at first start and consists of several steps. Following information will help you to avoid issues during that stage.

Welcome! Screen allows you to choose the desired language of the operational system of Prestigio MultiPad. Tap “Change language” button to access a list of available languages. You can select the language you need in this list, than you'll return back to the Welcome screen. Tap Next, read and accept End User License agreement to continue.

Please, note that in case you refuse to accept EULA (Dismiss button) you won't be able to proceed with device activation.

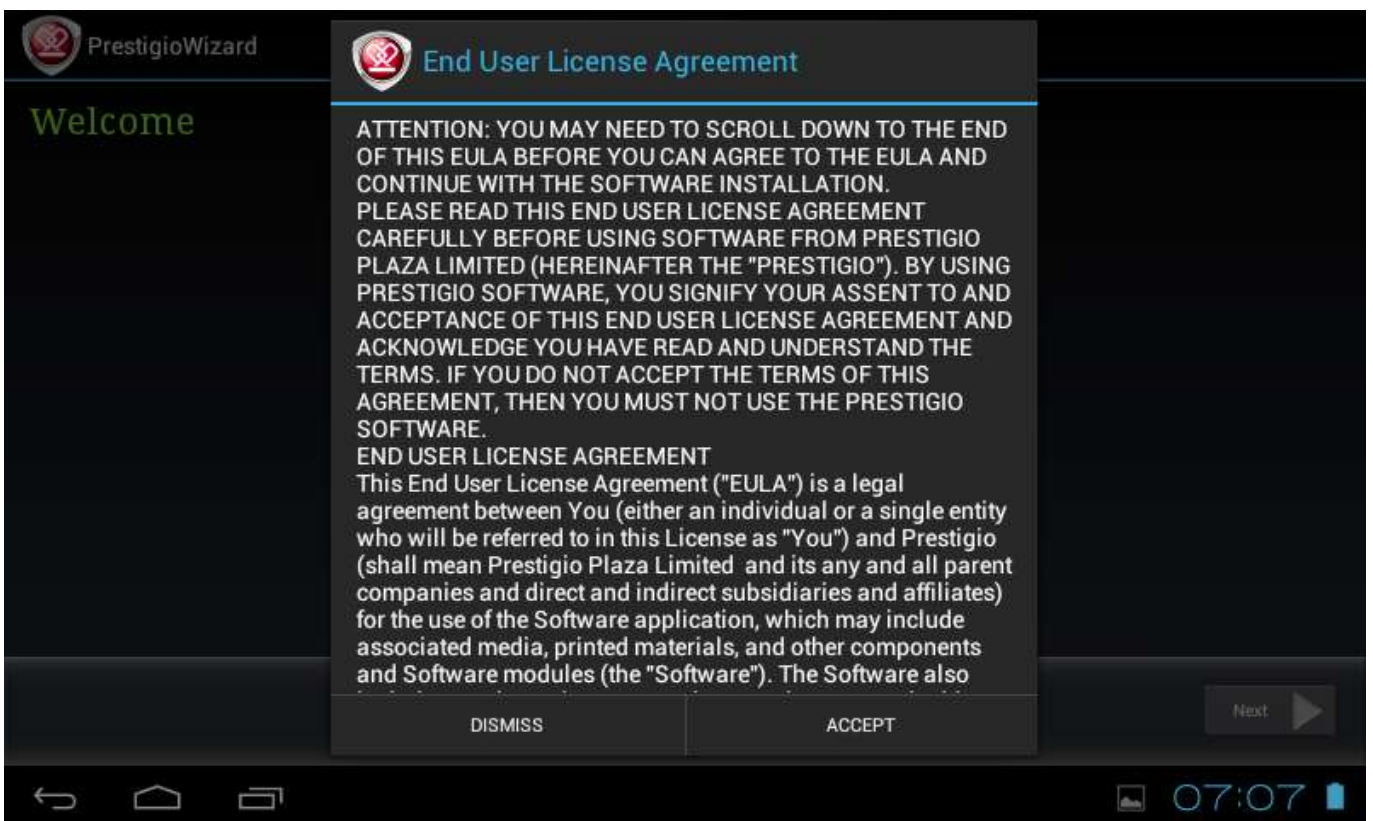
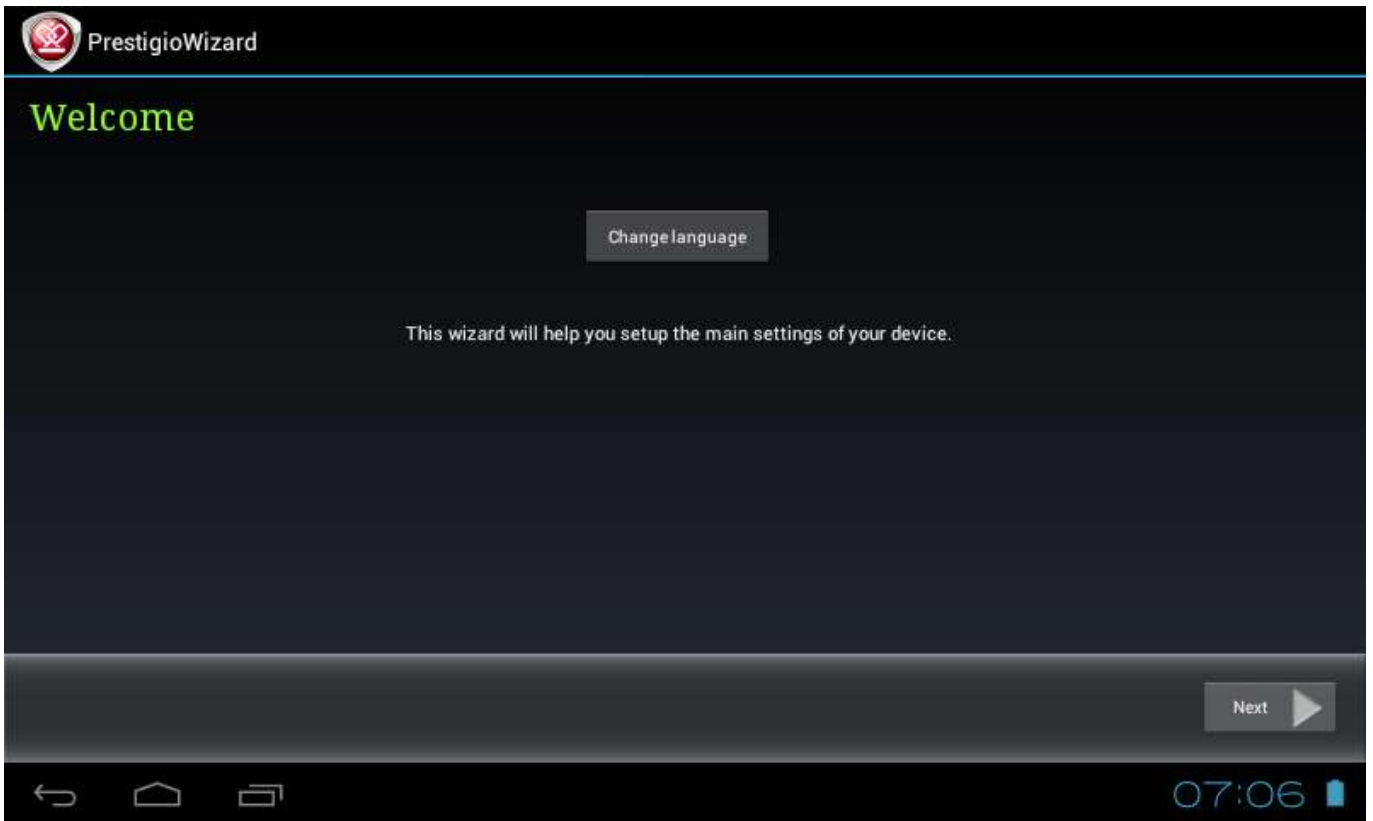

Keyboard Input Language screen provides users with option to select the necessary layouts of Android Keyboard.

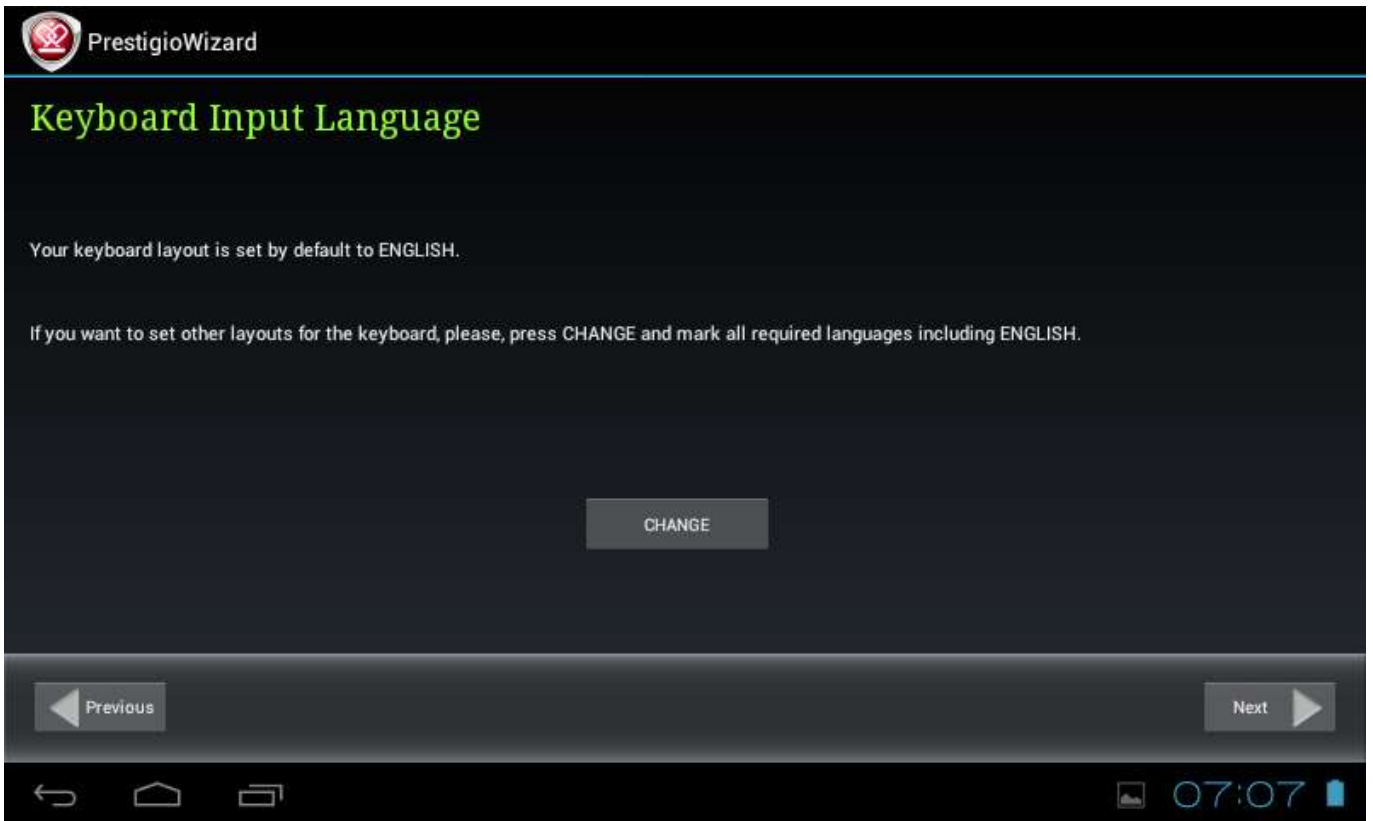

You may select several layouts (e.g. English (US) and German) by checking respective checkboxes.

Tap  and  to continue when ready.

Date and Time screen has to be used for exact Time Zone setup. By default the MultiPad tries to retrieve time information from Internet time servers. In case you do not have an Internet access right now you may use Advanced Options button, turn Automatic date & time OFF and configure manually.

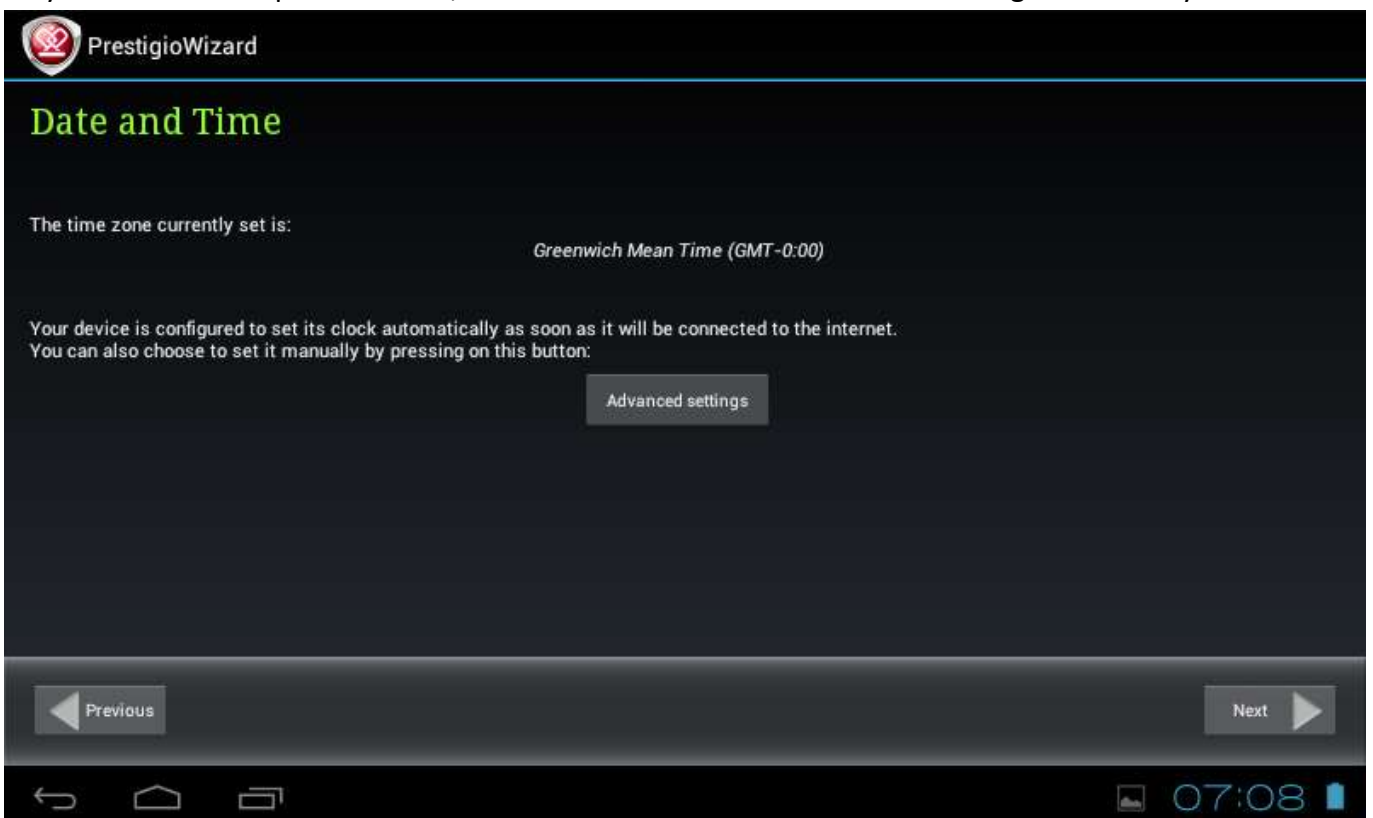

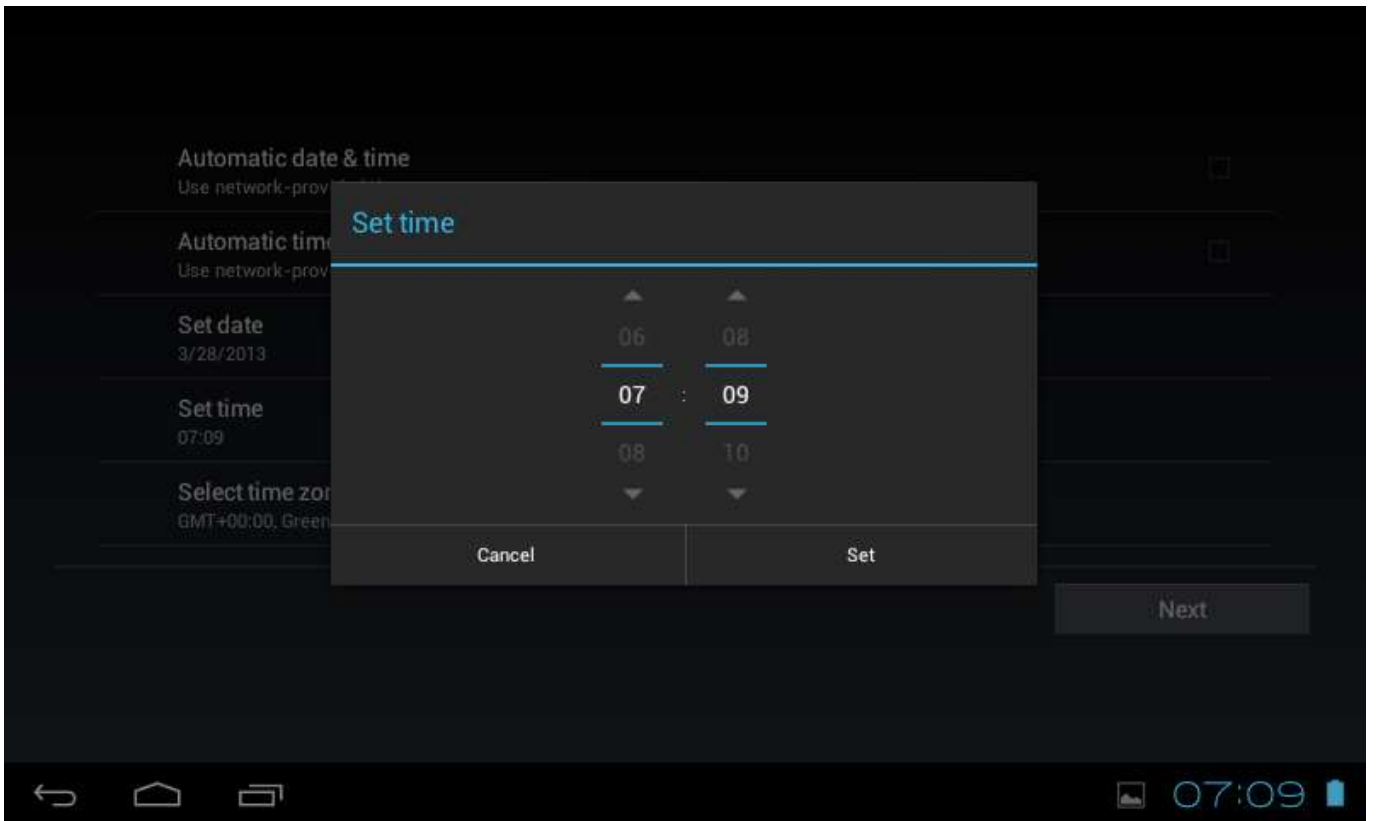

Tap **Next** button to continue to **Wi-Fi connections screen**.

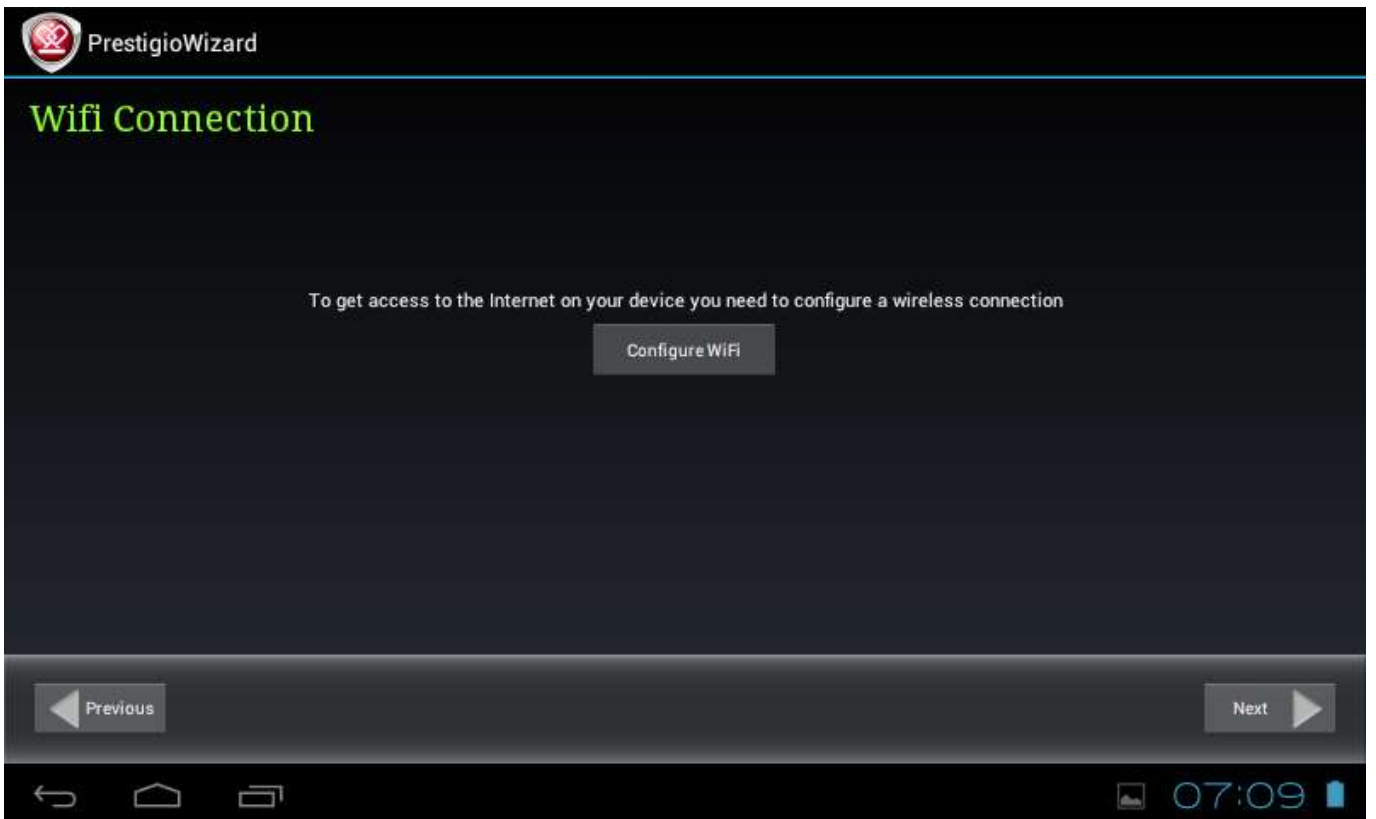

To connect to a Wi-Fi network, you should tap button **Configure Wi-Fi**, choose your wireless network name in a list and enter its password in pop-up menu:

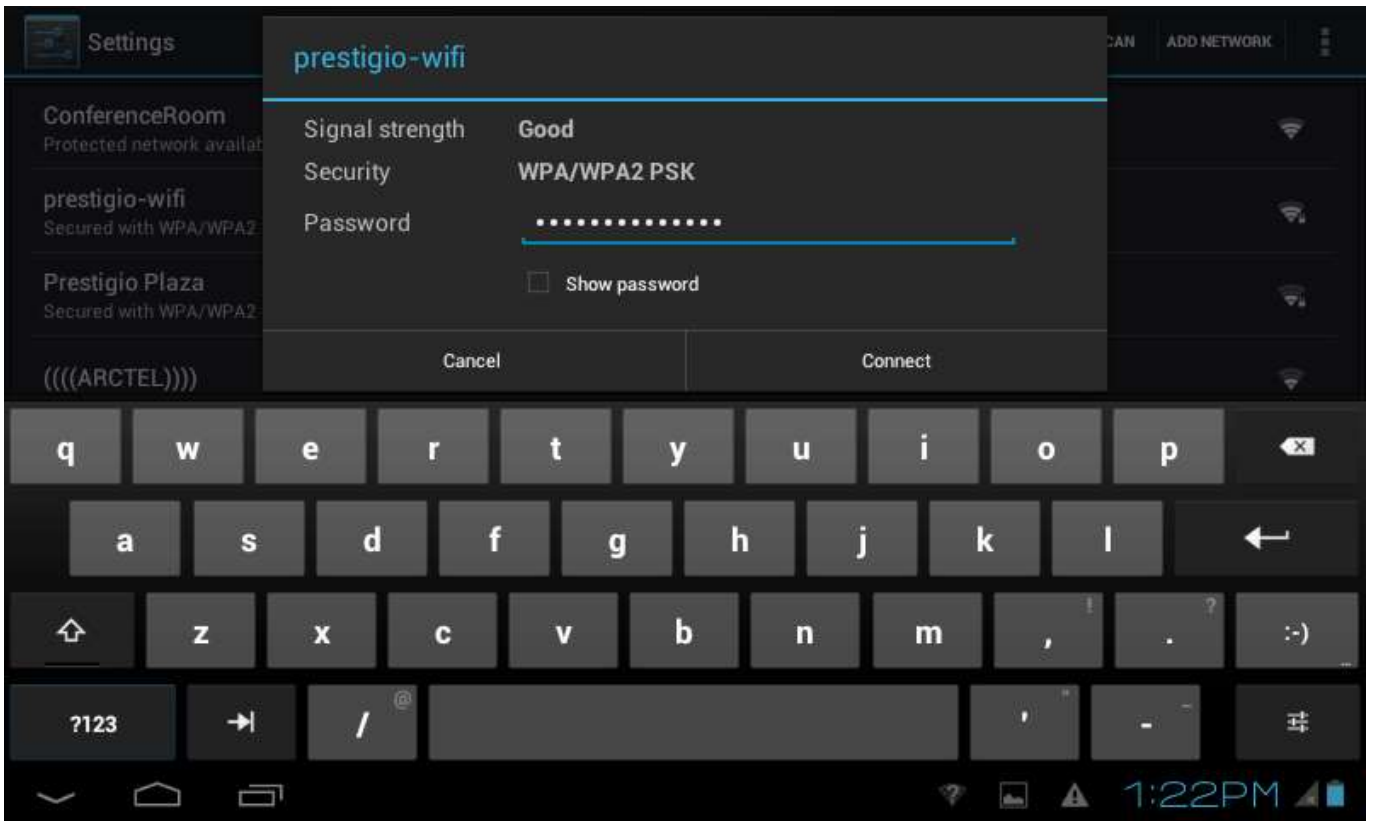

You may check the **Show Password** option in order to make it visible, but please consider the possible security risks.

After successful connection, the Wi-Fi connected icon  will appear on the status bar.

Tap  and  to continue.

Third party applications screen allows the customer to install the pack of programs which enhance Multipads functionality. Depending on the exact version of Firmware, the following options are available: A default Android **Third party applications** tool. In case of this option (see screenshot below) a user can either decide to install the pre-loaded content by tapping Install button, or skip the third party application stage. In case of **Don't Install** choice the wizard will automatically continue to final screen. Otherwise the installation sequence will be initiated.

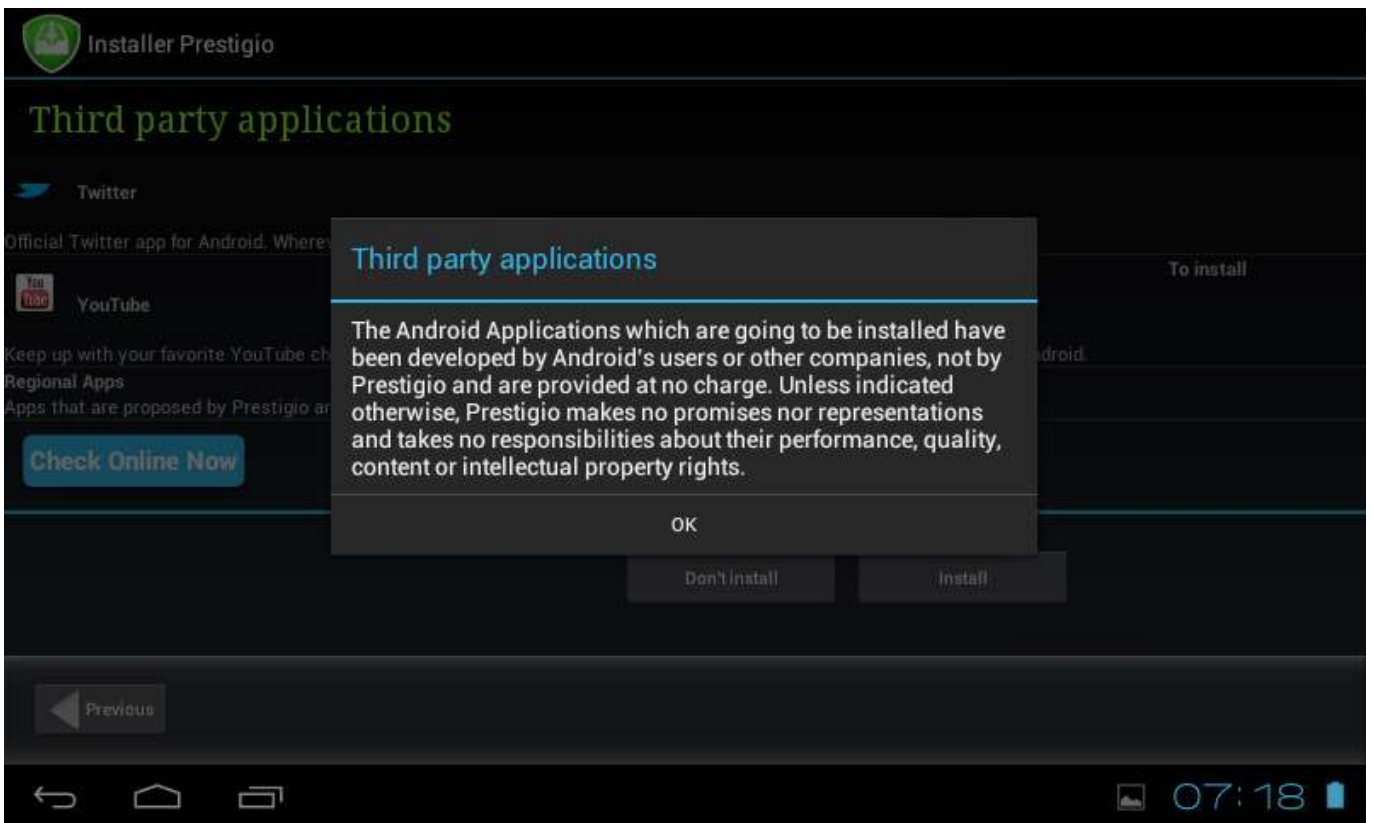

Alternatively, an **Installer Prestigio** could be launched instead of default third party installation wizard.

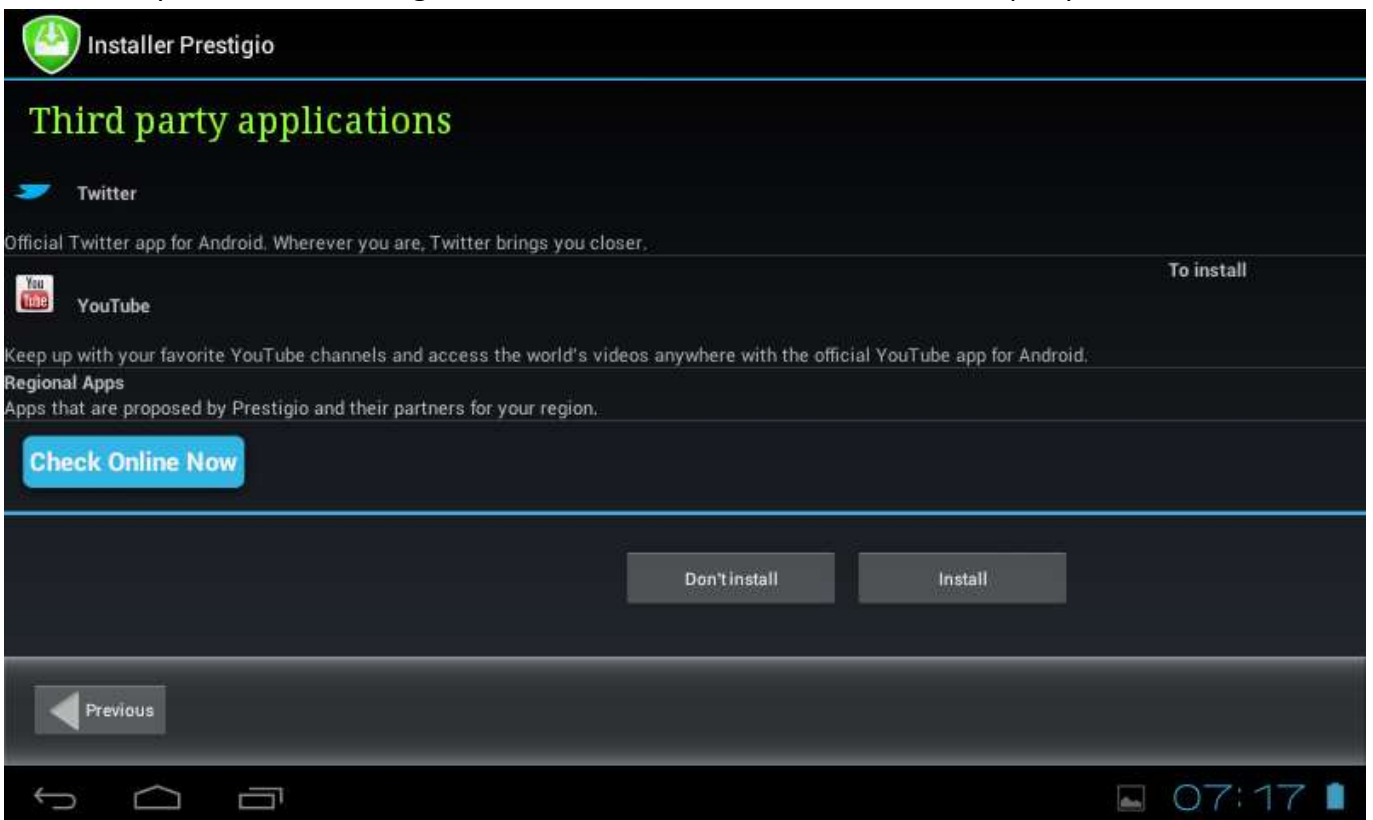

This utility has the extended functionality comparing the default Third party application utility. It provides user with the better tools for management of pre-loaded applications and games. **Installer Prestigio** scans the MultiPad for installation files pre-loaded during production, displaying the found application in a list. In addition, it offers the customer to check online Prestigio repository for applications and games for this particular model and region. Tap **Check Online Now** button to use this

option. Application name, as well as its brief description and size to download will be displayed in the list.

You may check the desired ones and tap **Download and Install** button. After you accept the Legal disclaimer the installation starts. After it finishes installation successfully Wizard will automatically continue to the **Thank you!** Screen.

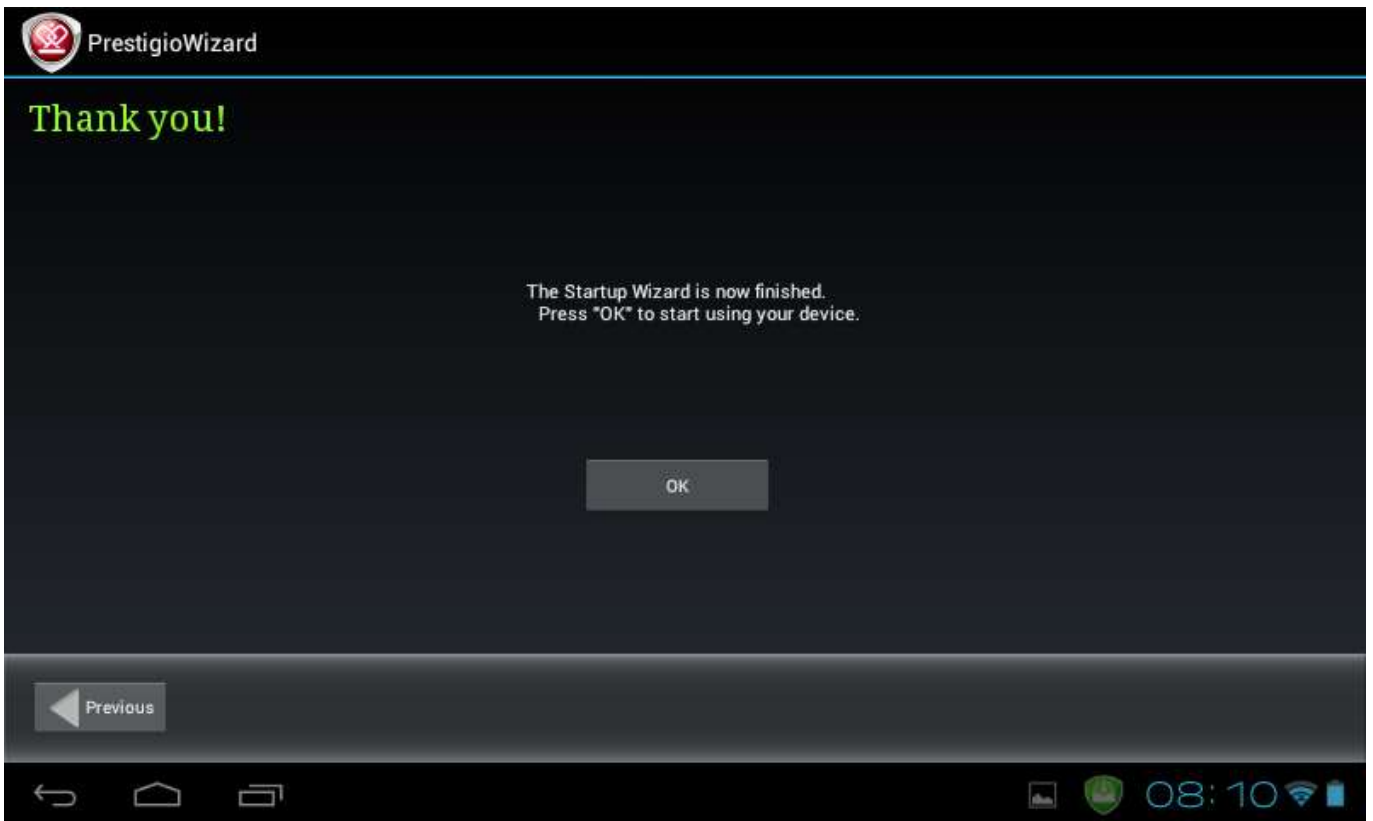

Now you can tap **OK** button and start using your MultiPad. Hope you will enjoy this experience. Thank you!

3. Home Screen



The Home screen is your starting point to access all the features on your device. It displays application icons, widgets, shortcuts, and other features. You can customize the Home screen with different wallpaper & widgets and display items you want. See the **Personalizing** section in this manual. When you start, the Home screen appears.

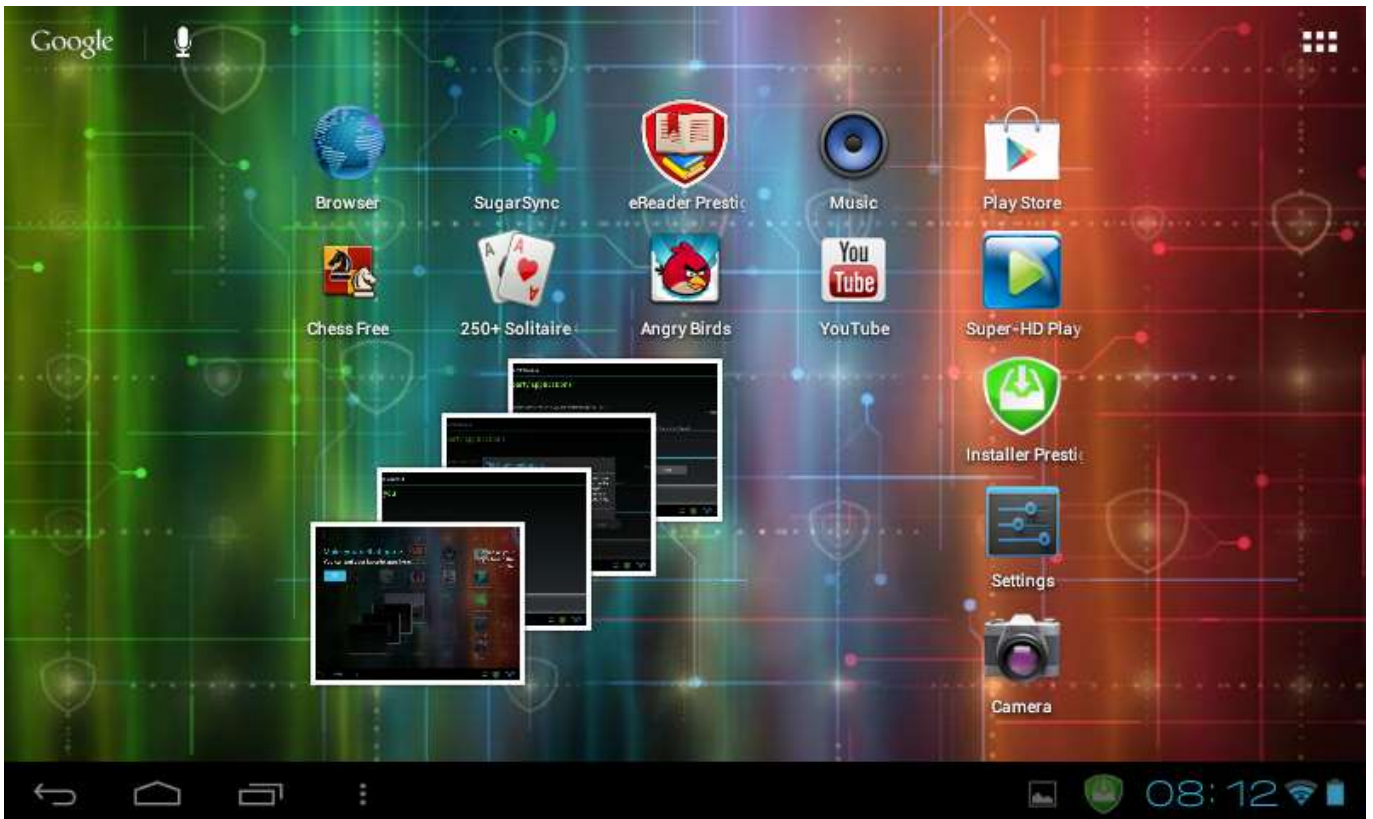

Sleep mode

Sleep mode suspends your device to a low power state while the display is off in order to save battery power. You will still be able to receive messages while the device is in Sleep mode.

[Note]: By default the device enters sleep mode automatically in case it's not operated for 2 minutes. You may change this time or even disable automatic sleep mode activation in menu **Settings-Device-Display-Sleep**.

Wake up from sleep mode

To wake up your device manually, press the Power Button. You will see a Lock Screen than.

Unlocking the screen

Touch the lock icon  , hold it and slide towards.

Please note, that depending on the direction you move the unlock icon, you may just unlock the

MultiPad  and enter Home screen, or start any other applications. Otherwise the installation sequence will be initiated.

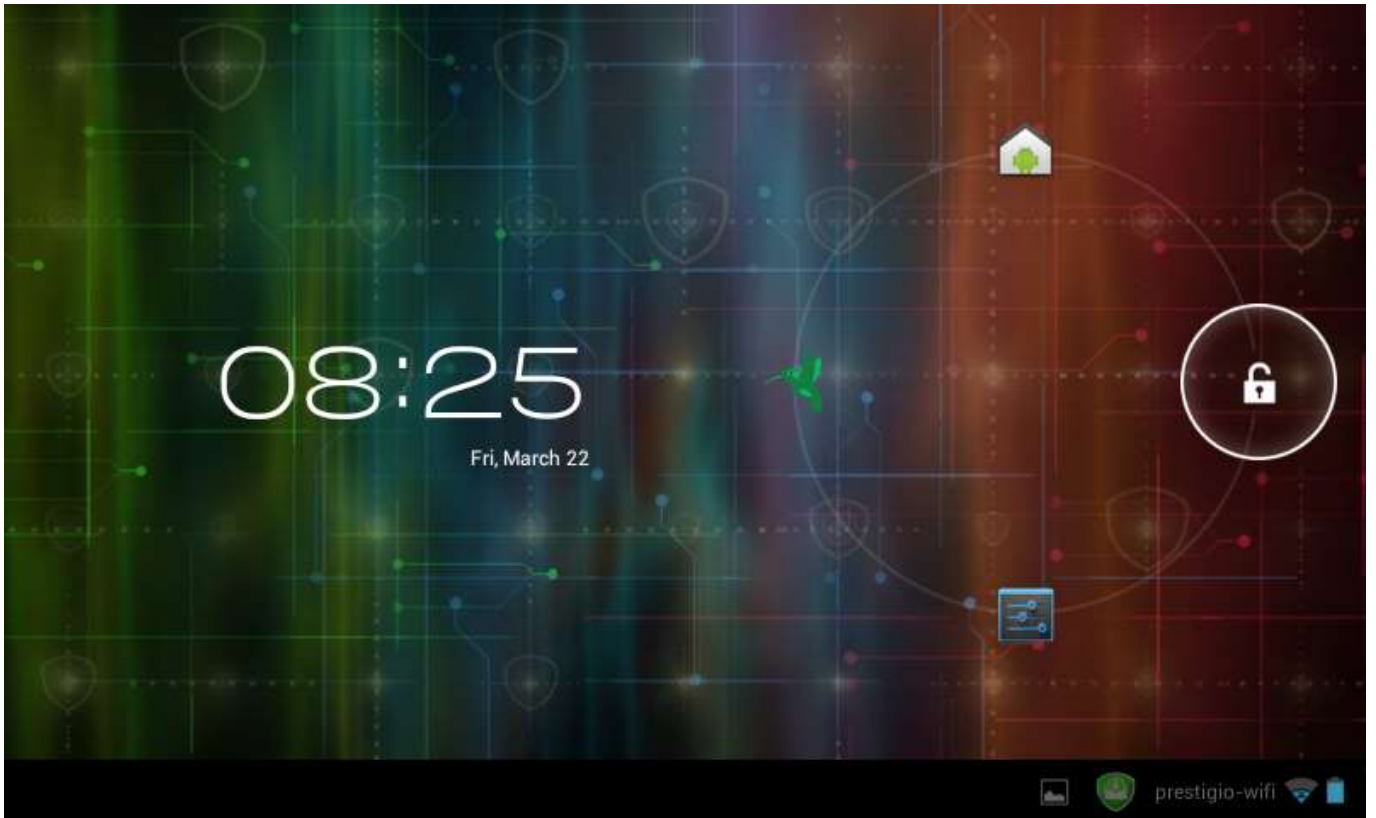

Other unlock ways, like PIN code, Face Unlock, Pattern etc. could be set up by user in menu **Settings-Personal-Security-Screen Security – Screen Unlock**.







Browse Home Screen







You can go to the extended Home screen by sliding your finger horizontally across the screen to go to the left or right side of the Home screen. Tap the icon  to view all applications on your device.

3.1 Status and notifications

Status and Notification Icons may appear.

The status bar contains different information like time and date, battery status, wireless networks status, active notifications from Android OS or installed applications and so on. When an application is running, corresponding notification icon will appear in the notification area. Icons you may often see are listed as follows:

| Status icons and its meanings | |
|---|--|
|  | Tap to go to the Home screen |
|  | Back |
|  | Recently applications view |
|  | Menu icon |
|  | Android debug bridge enabled |
|  | Connected to a Wi-Fi network and display the signal strength |
|  | Battery status |

| Notification icons its meanings | |
|---|---------------------------------|
|  | New Gmail (Google Mail) message |
|  | New Email message |
|  | Music player is ongoing |
|  | SD card is mounted |
|  | USB Connected |
|  | Airplane mode |
|  | Settings |

Open notification panel

If a new notification icon displays in the status bar, touch and hold the status bar, then slide your finger upwards to open the Notifications panel as follows:

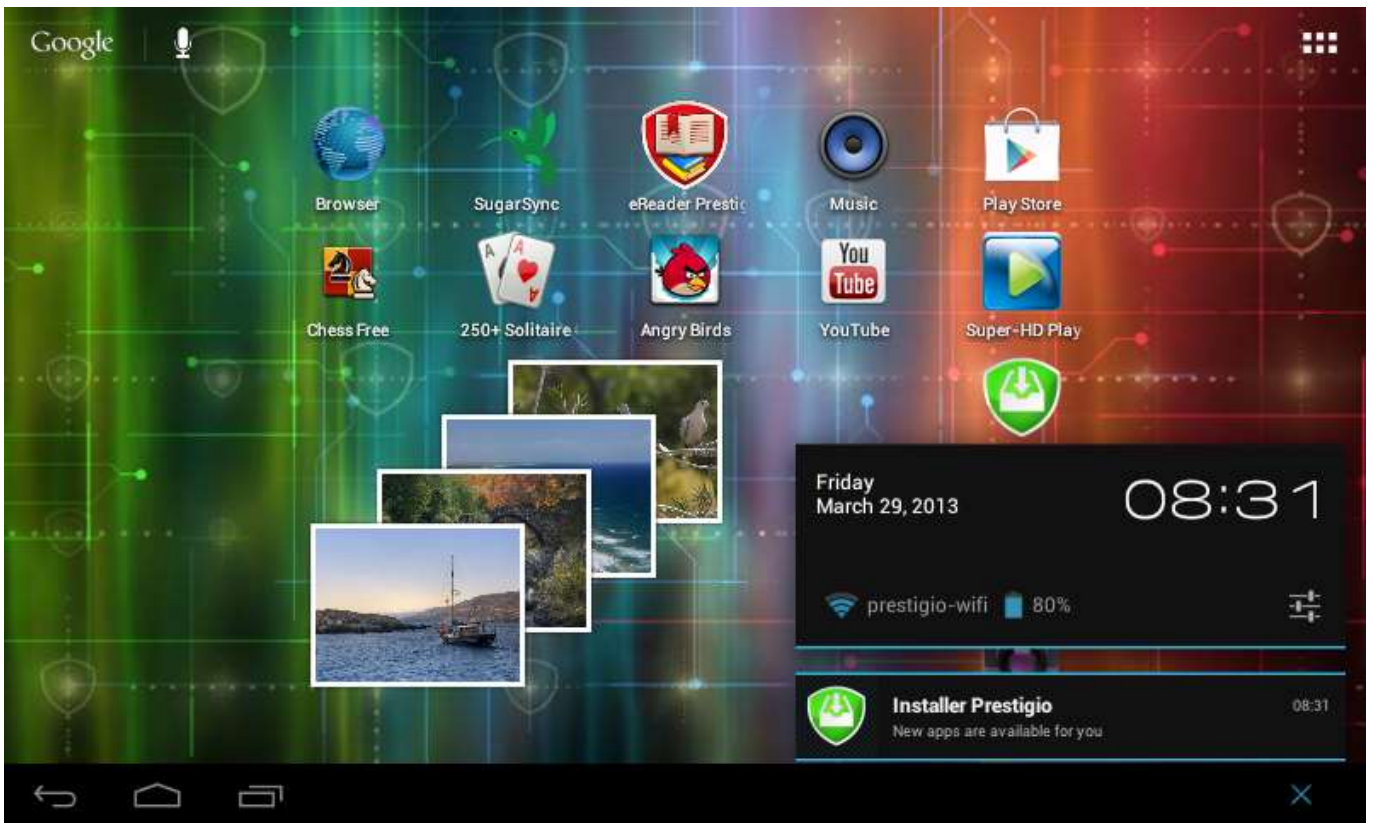

If you have several notifications, you can scroll down the screen to view more notifications. In the notification panel there are shortcuts for quick access to **Settings** and **Wi-Fi** tabs.

Close the Notifications panel

Simply touch the button  on the device panel.

3.2 Shortcuts to Add widgets

Widgets put at-a-glance important information and media content up front on your Home screen. Some widgets are already added to your Home screen for your convenience. You can add more from the available selection of widgets, or download more widgets.

Adding a widget to your Home screen

To add widgets to Home screen, you can:

- Tap  on the home screen to enter into all apps interface as follows

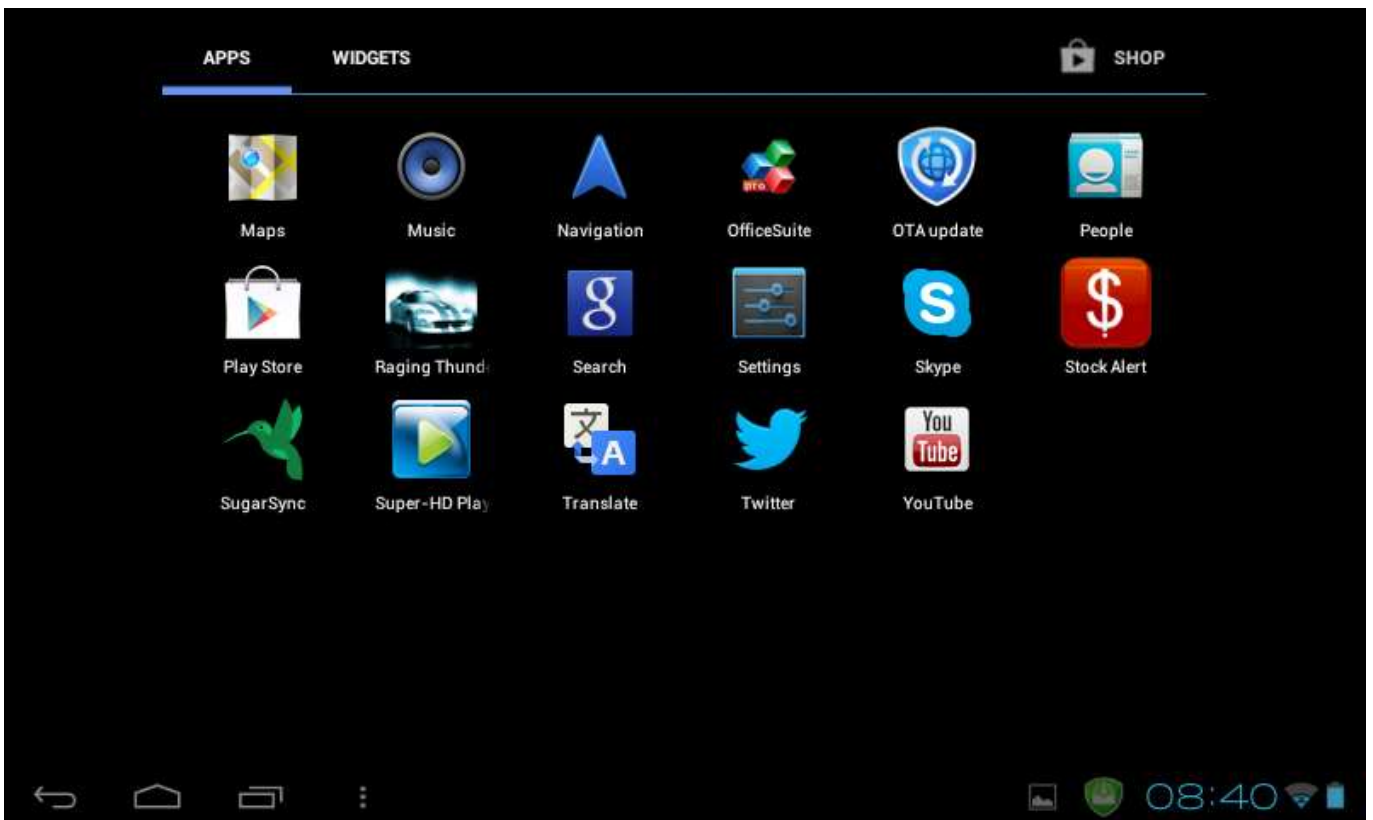
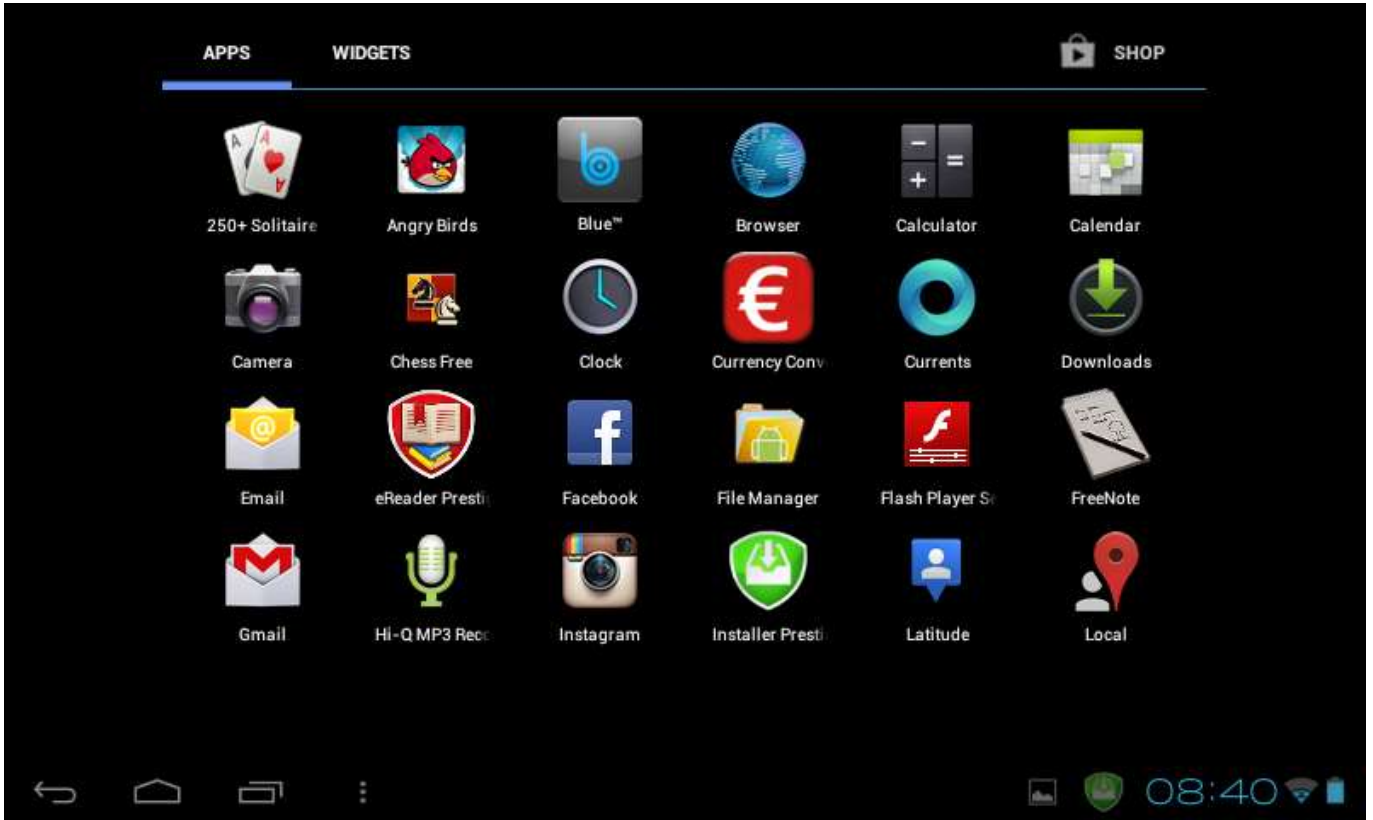

- Tap **WIDGETS**

- Select one item. Touch and hold your finger on widget. Choose desired place for widget on the home screen.

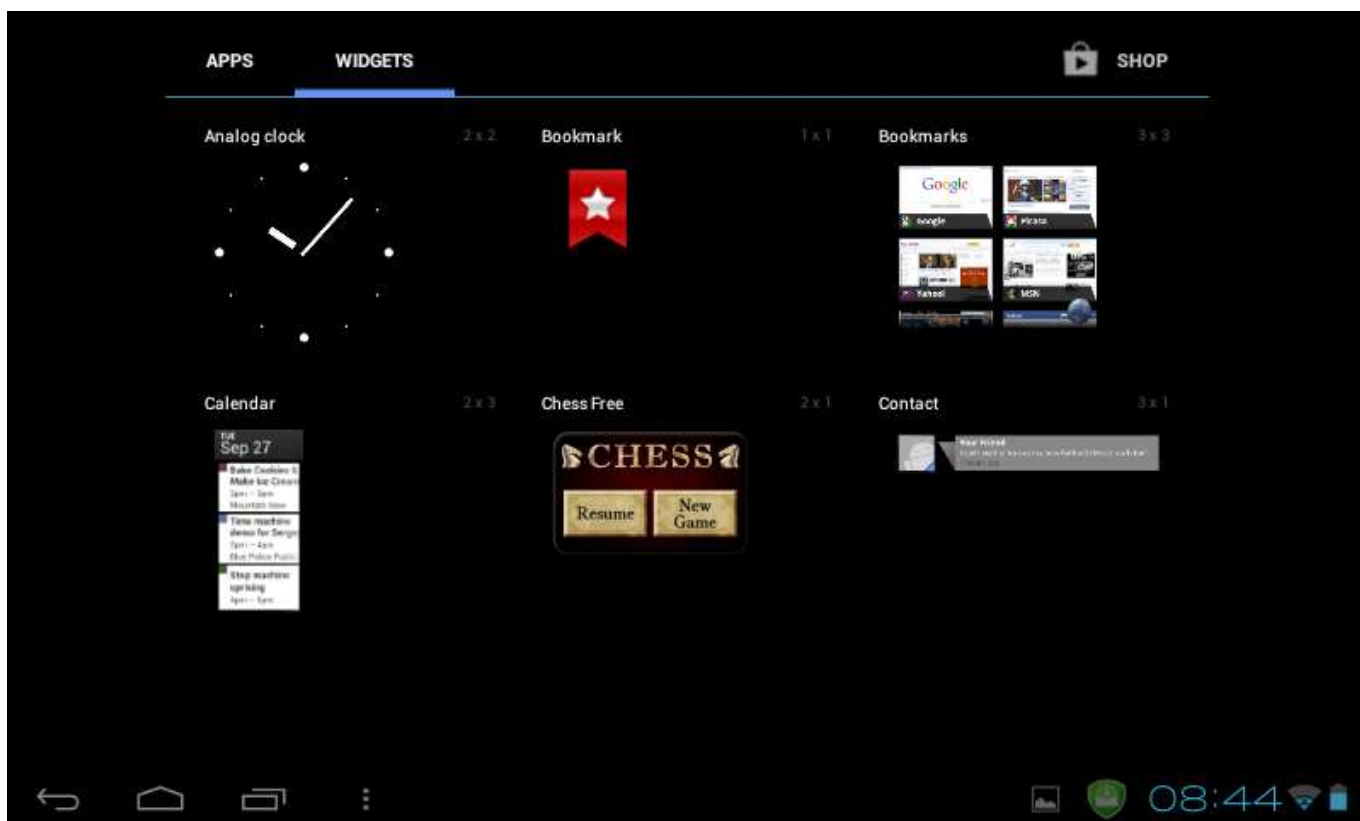

[Note]: When choosing place for widget you can switch home screen tabs by sliding finger with holding widget to the left or right side of the home screen.

Examples of Widgets are as follows:

Removing widget from your Home screen

To remove a widget, touch and hold the widget until the icon “X Remove” or “X” appears at the top of the screen, drag the widget onto it, so the widget you want to remove has become red and release your finger.

3.3 Finger gestures

Tap: When you want to type using the keyboard, select items onscreen such as application and settings icons, or touch onscreen buttons, simply tap them with your finger.

Touch and hold: To open the available option for an item (e.g. contact or link in a web page), simply touch and hold the item.

Swipe or slide: To swipe or slide means to drag your finger vertically or horizontally across the screen.

Drag: Touch the object before you start to drag. While dragging, do not release your finger until you have reached the target position.

Rotate: For most screens, you can automatically change the screen orientation from portrait to landscape by turning the device sideways. When entering text, you can turn the device sideways to bring up a bigger keyboard. Refer to Settings chapter for more details.

3.4 Coping files to and from the storage card

You can copy music, photos/pictures and others to MultiPad to personalize your device.

1. Use the USB cable that came with your device to connect it to an USB port on your computer.
2. When the icon  appears in the notification area, open the notification panel and tap **USB Connected** to popup the following screen:

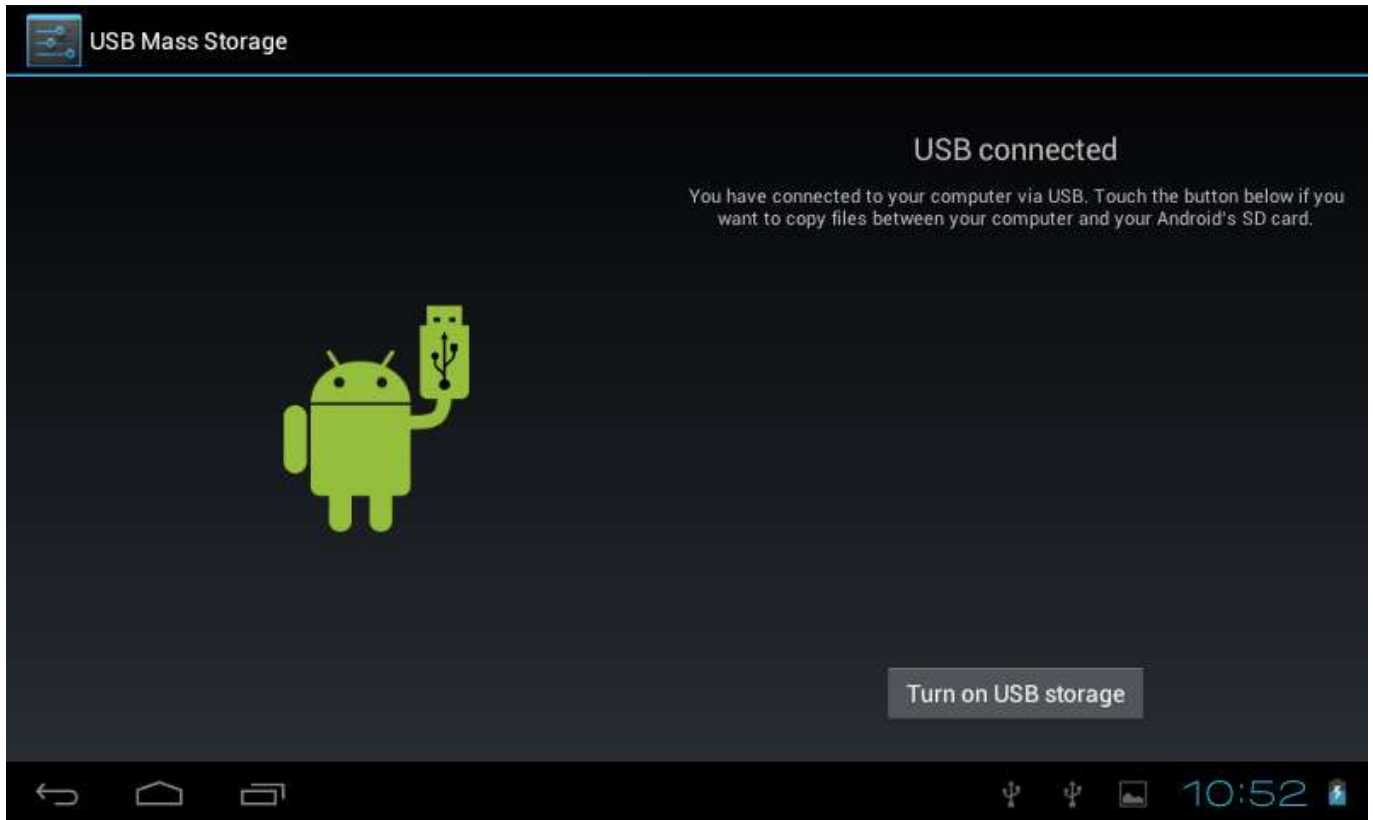

3. Tap **Turn on USB storage**, read popup notice, tap “OK” and when the notification icon  turns yellow, the computer will recognize your device as a removable disk;
4. Find the removable disk and open it. Do one of the followings:
 - Copy the files from the computer to the storage card’s root folder.
 - Copy the files from the storage card to a folder in your computer or computer desktop.
5. After copying the files, you may turn USB off. To do this, if you would like to keep your device connected to the computer and enable reading its storage card from Android, you can open the Notifications panel and tap **Turn off USB storage**. Otherwise, if you would like to disconnect the device physically from computer, please unmount the removable disk (that is, your device) as required by your computer’s operating system to safely remove your device.
6. Disconnect your device from the computer.

3.5 Searching the device and the web

You can search information in your device and in the Web by using the Quick Search Box. It’s placed on the top left side of the Home Screen:





Tap the magnifying lens, and enter the search item into the Quick Search box.

You may use also the following way:

1. Touch  on the home screen to enter into all apps interface;
2. Tap **Search** and then enter the search item in the Quick Search Box

As you type, matching items on your device and suggestions from Google web search are shown as a list. The suggested items that appear will depend on the options that you have selected in the search settings.

3. Do one of the following:

- If what you're searching for is in the list of suggestions, tap it in the list. The item opens in the appropriate application.
- If what you're searching for is not in the list, tap  to open the search settings menu. Tap Web and then tap  and Enter to search the Web. The web browser opens, displaying results of a Google search on the Web.

4. Personalizing

4

4.1 Change the Notification ringtone

Choose from the available selections of notification ringtones on your device. You can also download or copy notification ringtones or songs to your device's storage card and choose one to use as your notification ringtone. To find out how you can copy files to your storage card, see “Copying files to and from the storage card”.

1. In the Home screen, tap Settings > Sound > Default notification.
2. Tap the notification ringtone you want to use. The notification ringtone briefly plays when selected.
3. Tap **OK**.

4.2 Change your wallpaper

Personalizing your Home screen wallpaper with your favorite photo is a quick and easy way to change the feel of your device and give it a fresh look. Browse the collection of wallpapers included in your device or choose from photos that you have taken with the camera.

To change your Home screen or lock screen wallpaper:

1. On the Home screen touch and hold your finger at the free area. **Choose wallpaper from** menu will appear.

[Note]: You can also tap  Settings>Display>Wallpaper to reach **Choose wallpaper from** menu.

2. Choose source and wallpaper you would like to use.

You can do one of the following:

- Tap **on the pictures on your screen** to select a photo/picture that you have taken using the camera or copied to your storage card. Tap **Crop** to crop the photo/picture and set the cropped picture as wallpaper.



- Tap **Wallpaper** gallery to choose from preset wallpapers and then tap **Set wallpaper**.
- Tap **Live Wallpaper** gallery to choose from preset live wallpapers and then tap **Set wallpaper**.

4.3 Personalize your Home screen with folders

Use folders to group related applications and other shortcuts to keep your Home screen tidy and organized.

4.3.1. Adding folders on your Home screen

Touch and hold the application shortcut and drag it onto another shortcut to create a folder for the applications you want to file together, and then release your finger to finish creating a folder. You can drag any other application shortcut into the new folder.

To rename a folder:

1. Tap the folder to open it.
2. Tap **Unnamed Folder** to prompt the keyboard.
3. Enter a new folder name and then tap Enter key.

4.3.2. Removing folders from Your Home screen

Tap the folder you want to remove to open it. One by one touch and hold application shortcut inside folder and drag it out of the folder. When only one application shortcut will stay inside the folder, folder will be automatically deleted.

[Note]: During operations with folders your application shortcuts are not removed.

4.4 Rearrange widgets and shortcuts on your Home screen

Rearrange widgets and shortcuts on your Home screen to get space for adding more items to the Home screen.

4.4.1. Moving a widget or shortcut

1. Gently tap and hold the widget or shortcut you want to move.
You'll see a blue edging around the widget or shortcut. Don't release your finger.
2. Drag the widget or shortcut to a new location on the screen.
Pause at the left or right edge of the screen to drag the widget or shortcut onto another Home screen panel.
3. When the widget or shortcut is where you want it, release your finger.
If you've released your finger but a message shows that there's no space to place the widget or shortcut, drag it right or left again to another Home screen panel.

4.4.2. Removing shortcuts

To remove a shortcut, touch and hold the shortcut until the icon "X Remove" or "X" appears at the top of the screen, drag the shortcut onto it so the shortcut you want to remove has become red and release your finger.

5. Web browsing

5

User can connect to the network via the browser.





Tap the browser icon on the Home screen to open it as follows:





Use keyboard to type URL (web-site address) or search phrase at the address bar.

Please note, that the browser supports tabs, you may open multiple tabs in a single browser window, switch them by a single touch or close the tabs at your choice.

Touch  to open a new tab.

Touch  to close the tab.

 this icon allows you to reload the active page.



To exit browser application just tap Back button .

6. Manage Applications

6

You can personalize MultiPad and enrich your experience with it by installing a wide variety of free and paid apps ranging from productivity apps, entertainment, to games. When you find a program you want, you can easily download and install it on your MultiPad with just a few steps as follows:

How to install Android programs

1. Tap  at the Home screen to enter into all apps interface. Run **Play Store** application. 
2. During first launch Play Store will request you to login or register a new account. Enter your E-mail and password if you have a Google account already. Otherwise tap Create account and follow the instructions.
3. After signing in you will be able to search, download and install applications from Play Store. Some applications are free, while other might charge you through credit card.
4. Use Play Store interface to install program to your device.

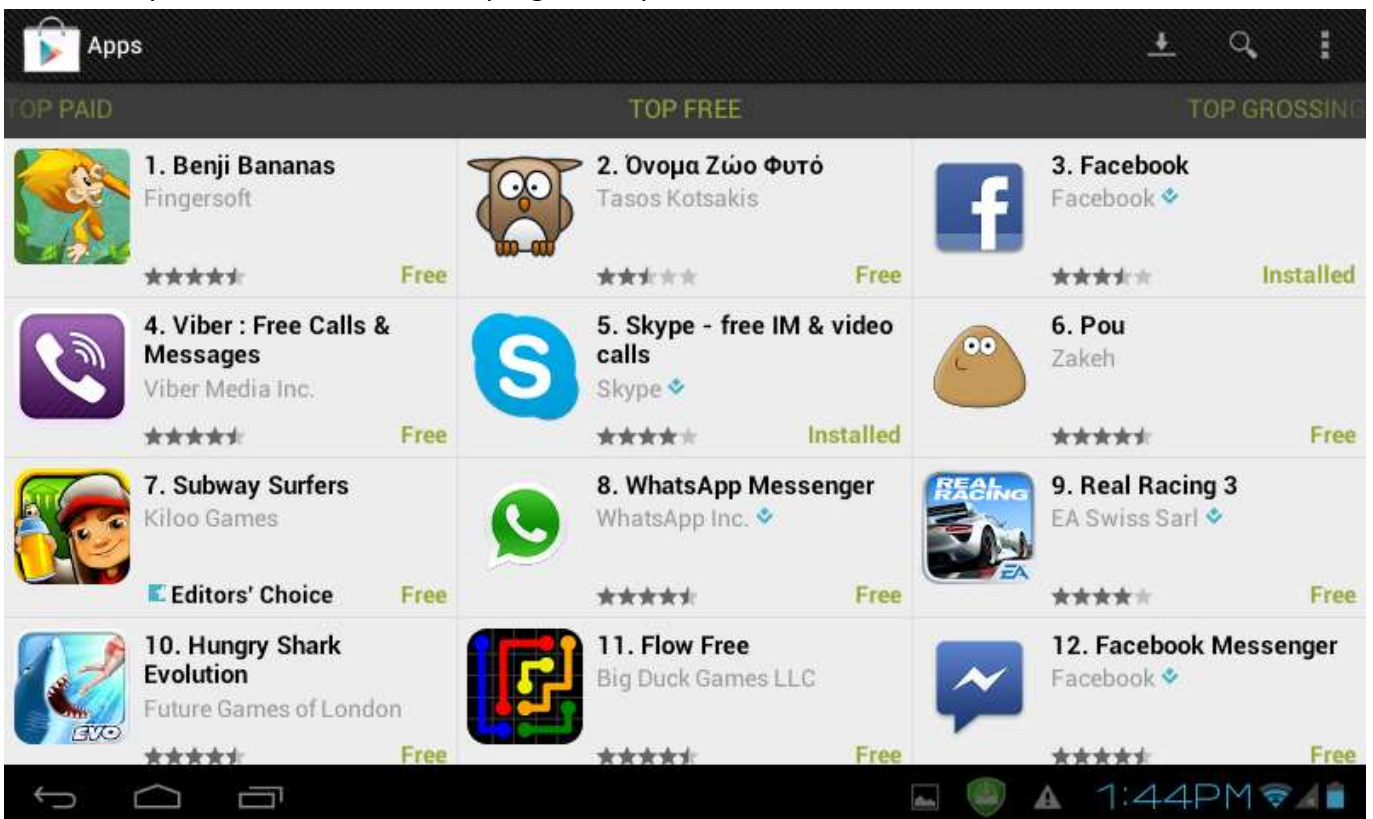

How to uninstall Android programs

To uninstall the program:

1. Go to **Settings > Apps > Downloaded** menu
2. Tap on program you want to uninstall
3. Tap **Uninstall** and **OK** in popup menu.

[Note]: You can also use an alternative way of uninstallation: enter the list of applications, tap the application you'd like to uninstall, hold it and drag to the "Uninstall" icon on top of the display.

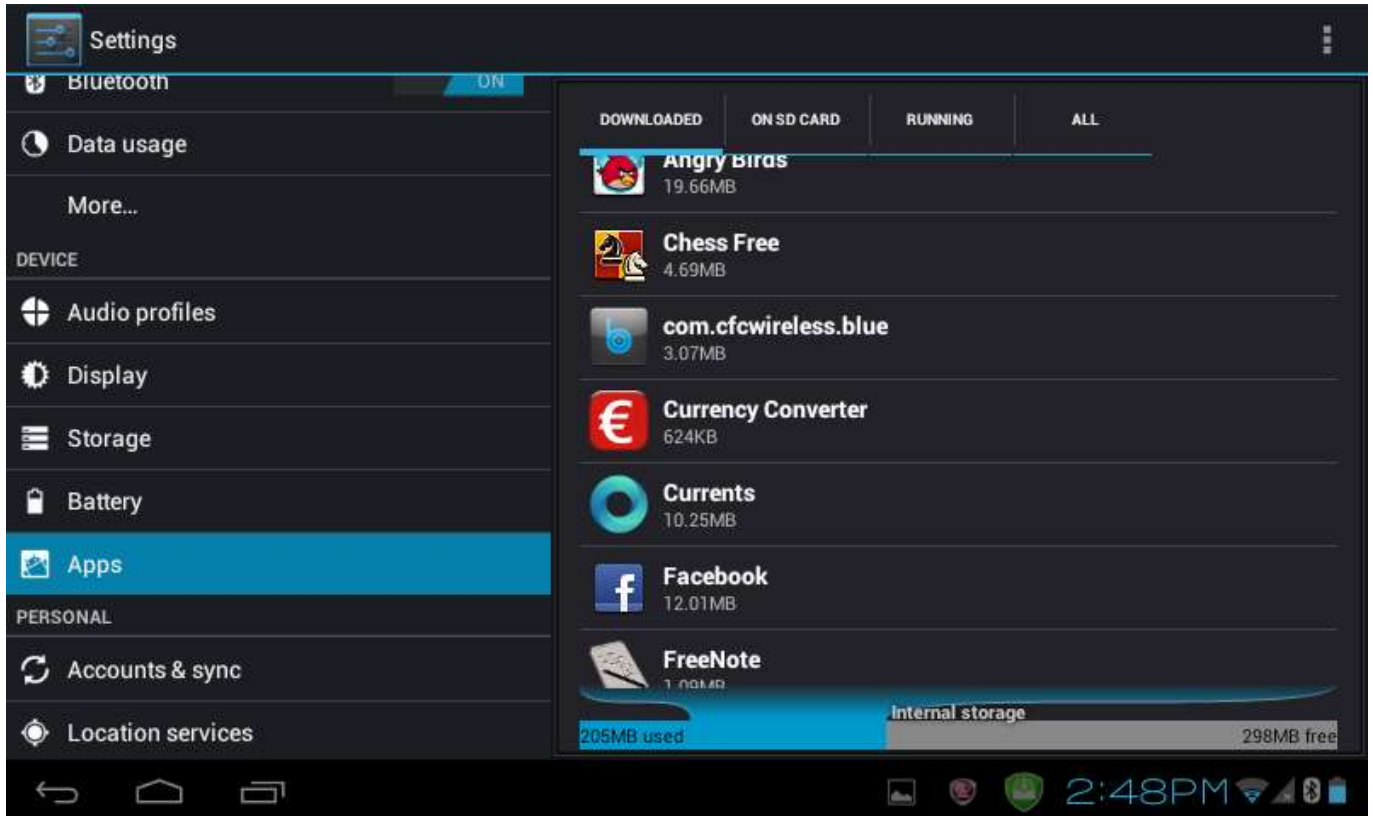

7. Typical applications



7.1 Music Player

Enjoy listening to songs and music on your MultiPad using the Music application. You need to copy music files to your storage card first to use the Music application to play music. To find out how to copy files, see **“Copying files to and from the storage card”**. Supported audio formats see in MultiPad technical specifications above.





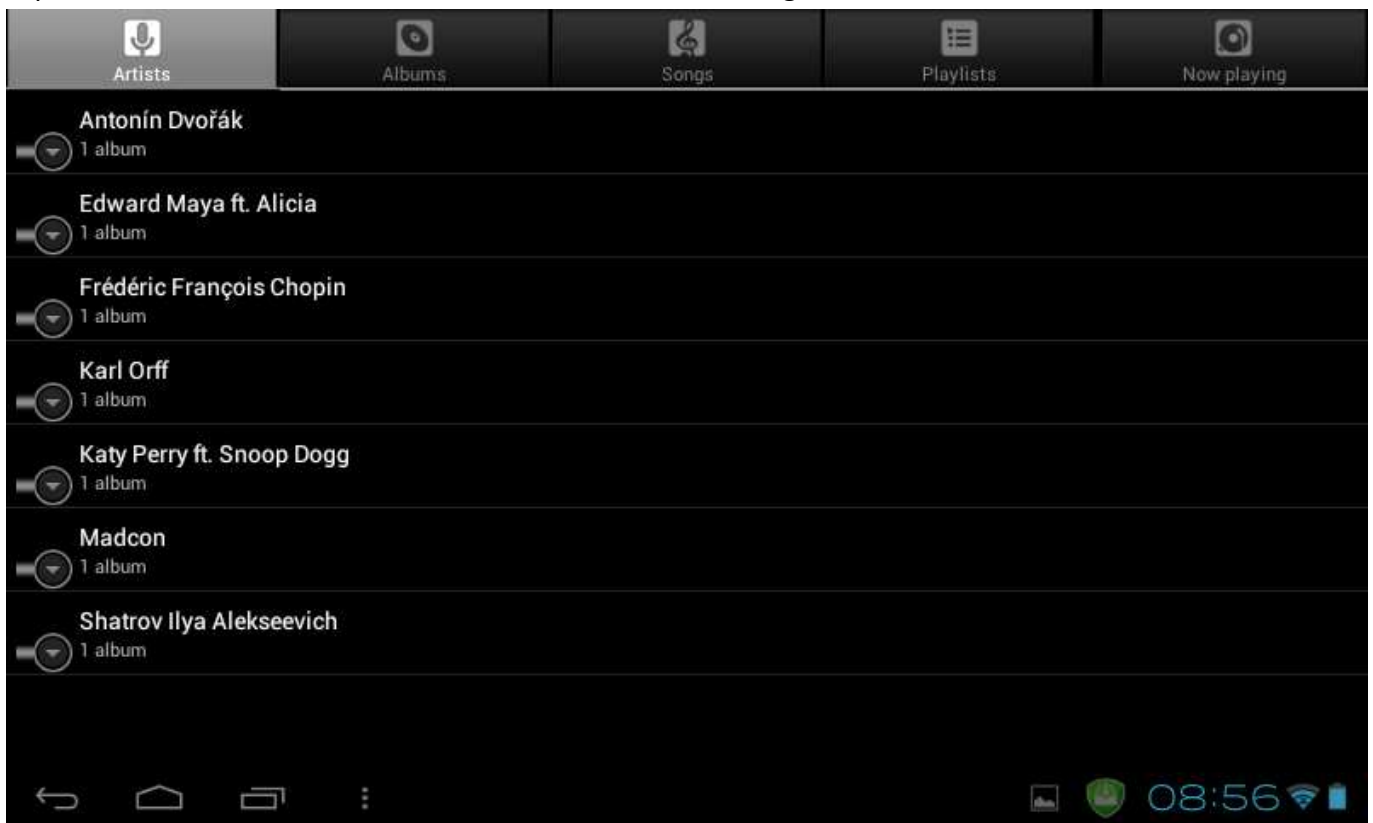

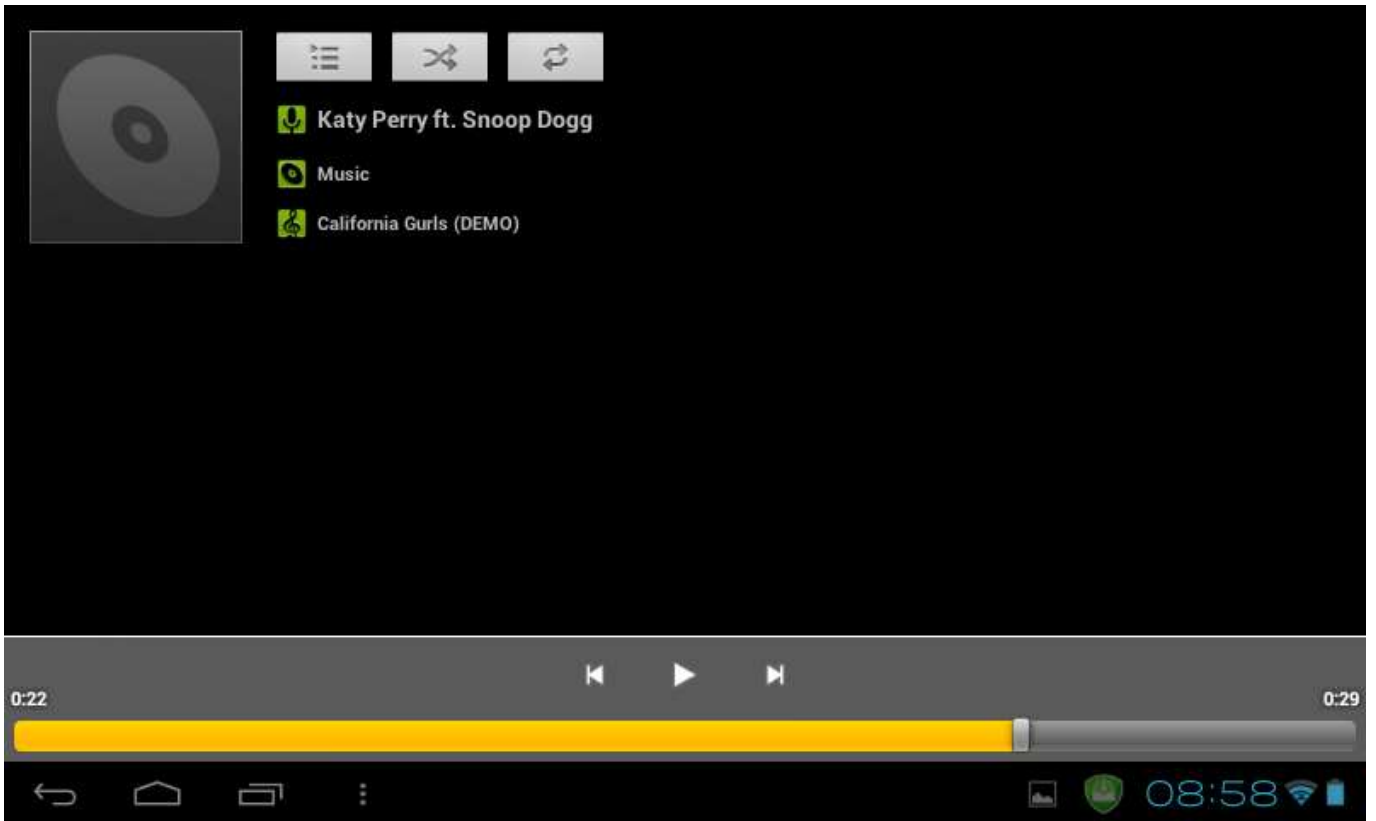

Tap the icon **Music** on the Home screen to enter the following screen:







Your music is organized into different categories such as Artists, Songs and Albums. Tap one of the category tabs to view a category.

Select a song in the playlist and tap on it to start playing as follows:

| | |
|---|--|
|  | Tap to go to the previous song. |
|  | Tap to play, pause, or resume playing the song |
|  | Tap to go to the next song |
|  | Tap to go to the now playing list |
|  | Tap to switch the following repeat modes: repeat all songs, repeat current song, do not repeat |
|  | Tap to shuffle the current playlist. |

When you are playing music and the screen turns off, you can control the music playback volume with hardware buttons Vol+ \ Vol-.

7.2 Video Player

Tap the launcher icon  on the Home screen and then tap the Super-HD Player icon  to go to the following interface:

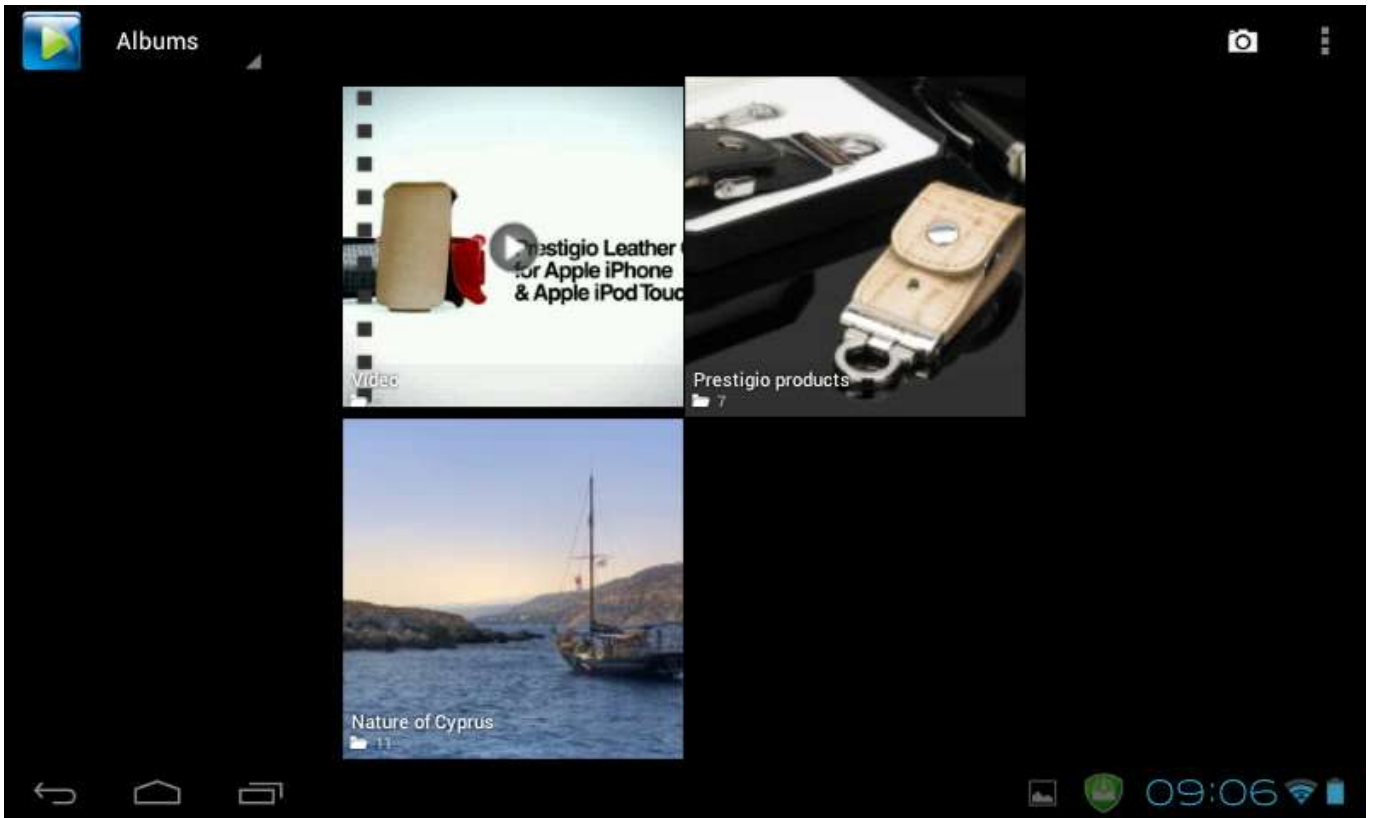

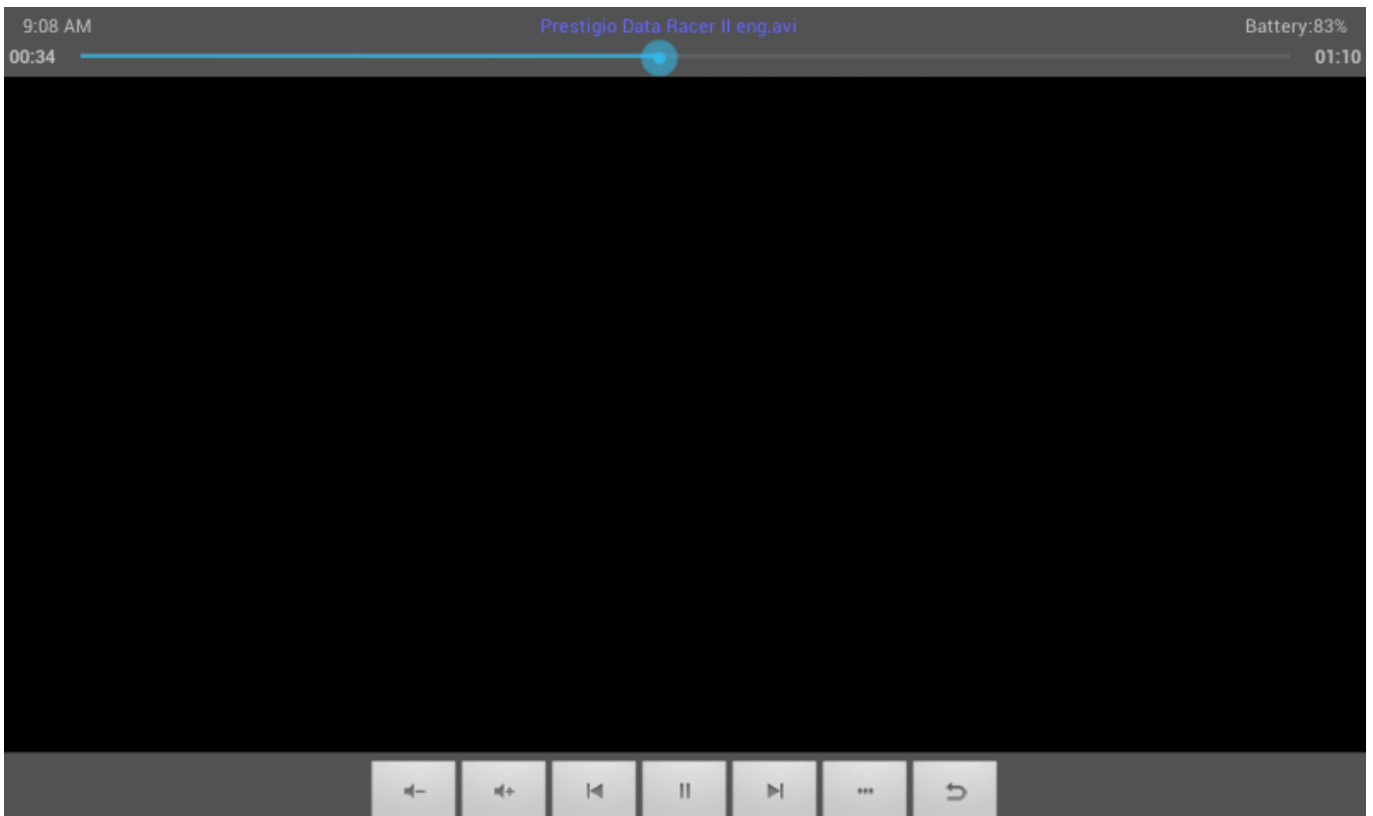

Double tap on a video file to start playing it.



To quit the video playing screen, touch the Back icon  in the status bar directly.

7.3 Gallery

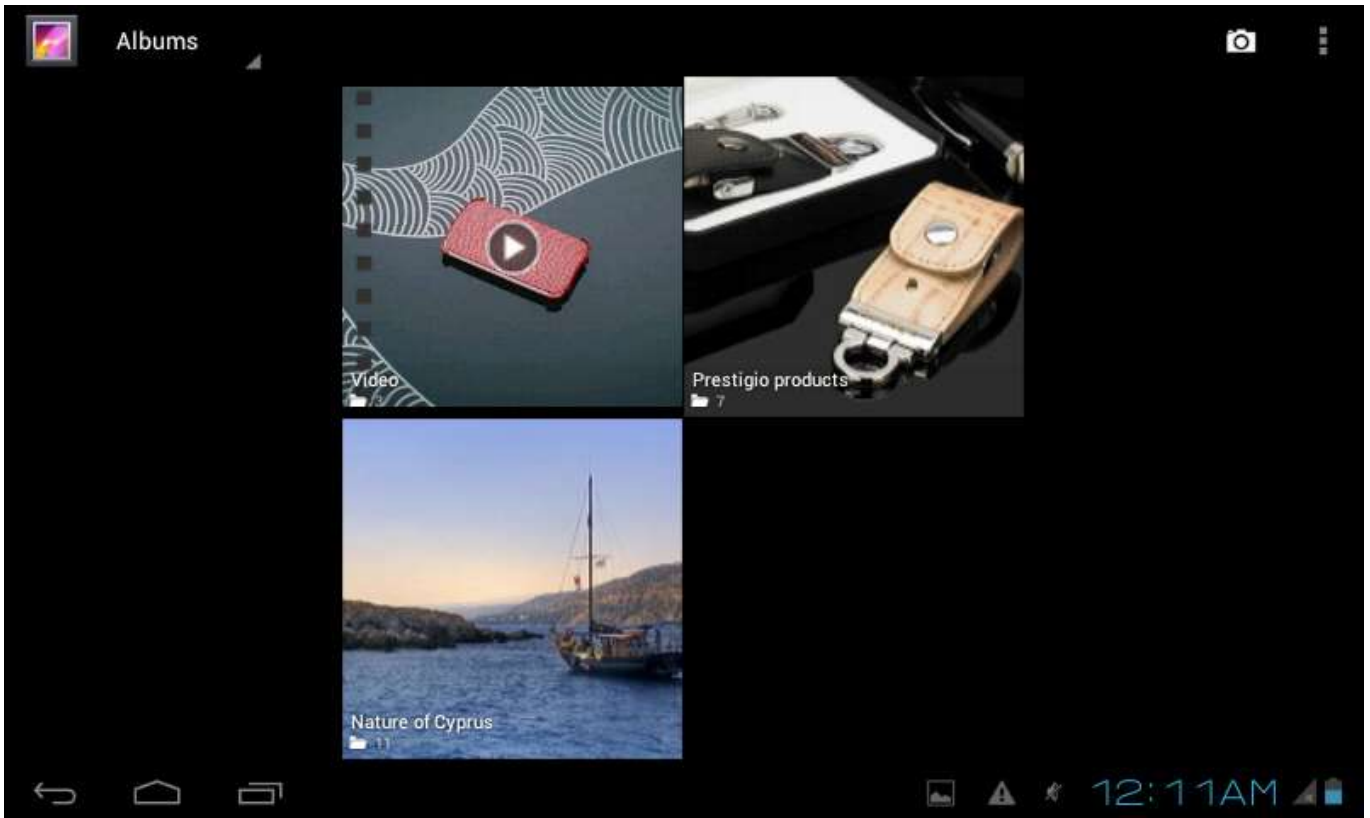

You use Gallery to view pictures and play videos that you've taken with Camera, downloaded, or copied onto your SD card. You can perform basic editing tasks on pictures and set them as your wallpaper or contact picture. You can also share your pictures and videos with friends.

On the Home screen tap the launcher icon  and Gallery  icon after. Photos and videos are classified automatically for easy view. The gallery application will run and the interface is as follows:



Browse & edit pictures/photos

Tap an album to open it and view its contents;

-  - this icon could be found on upper right corner of the screen; it allows you to browse all photos/pictures in slideshow mode.
- 

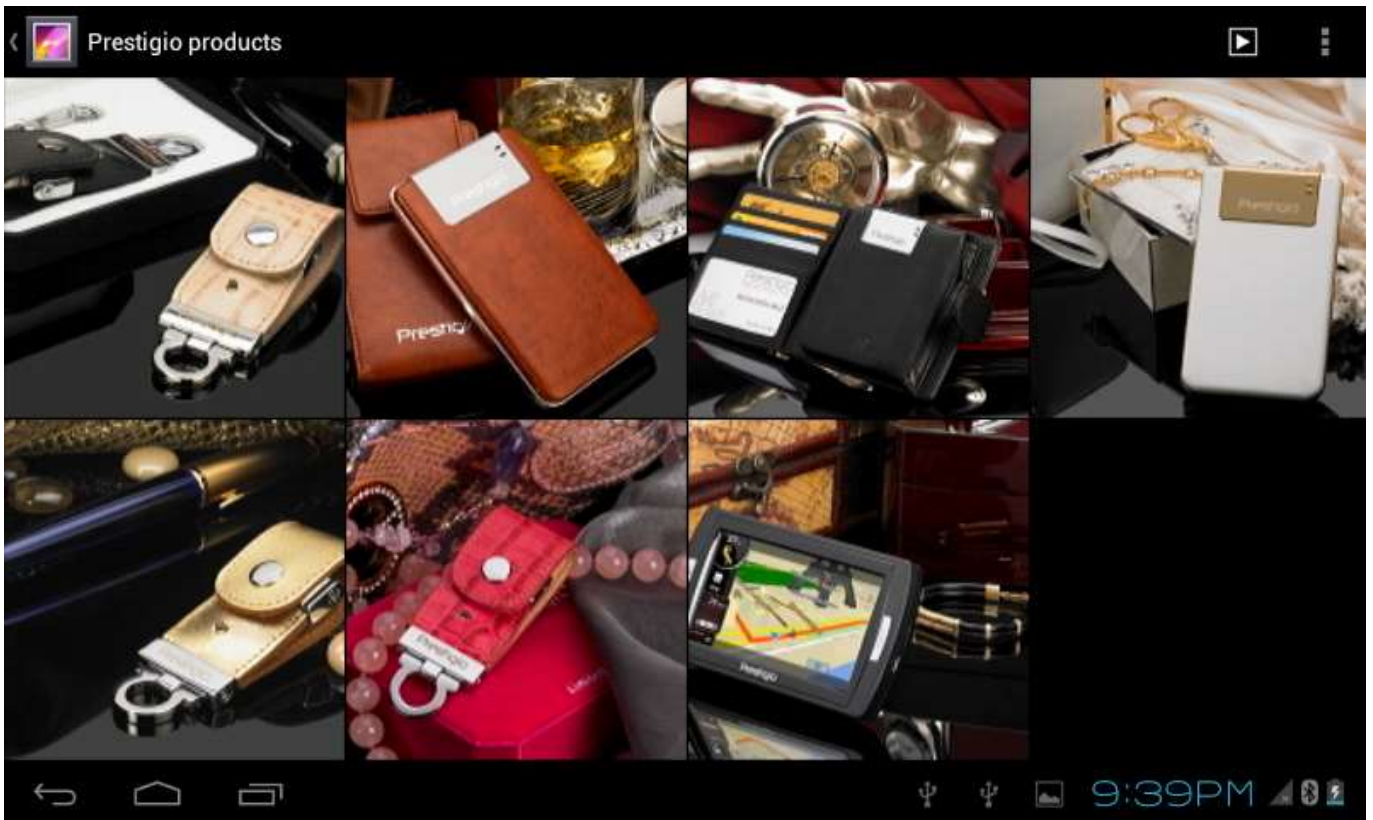

Select a picture to view it in full screen mode; drag left or right to view the next or previous picture in the album; move your fingers inward/outward to zoom out/zoom in the selected photo/picture.

 - this button allows you to share it with friends via email, Twitter, Facebook etc.

Use delete icon  to delete the selected files.

Tap  to pop-up the following control menu:

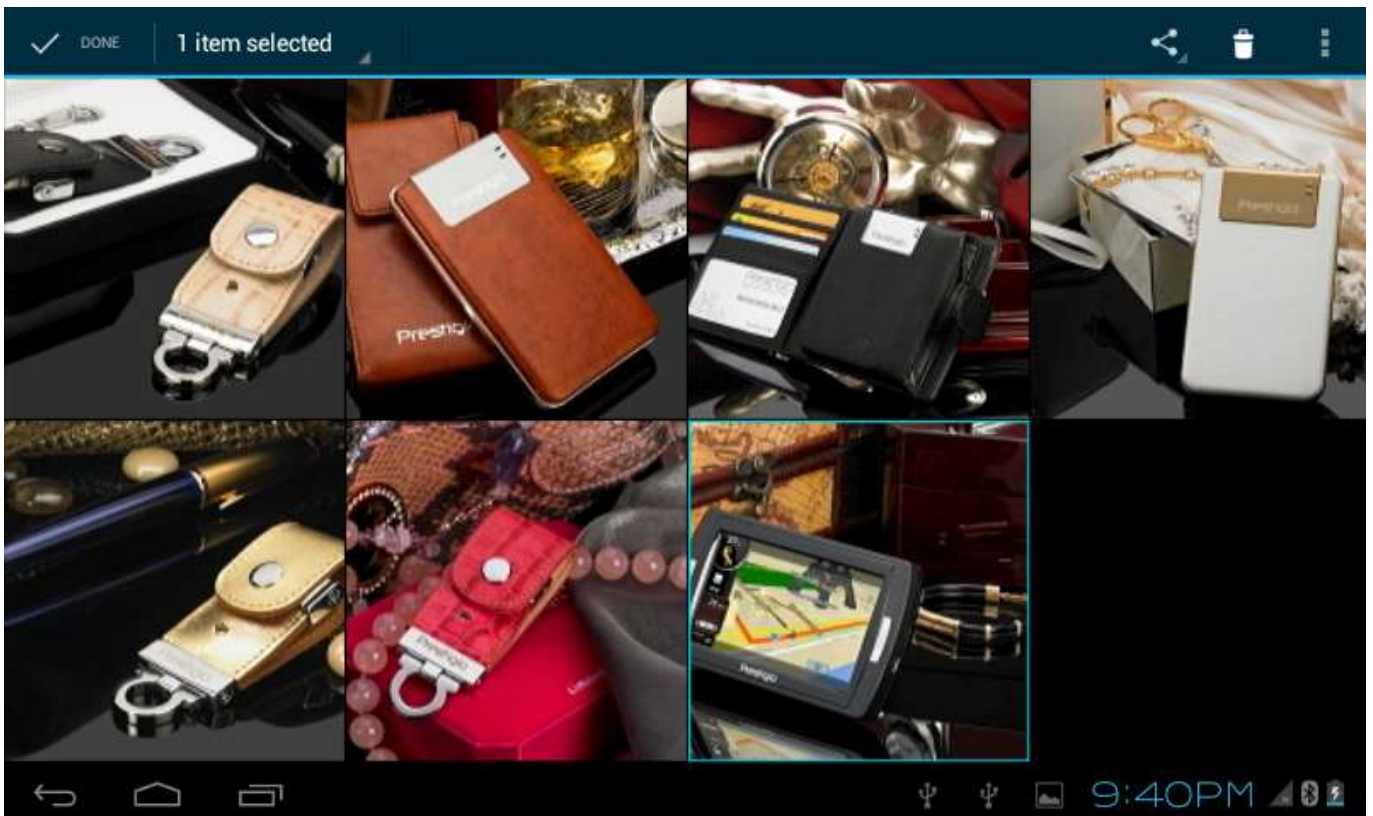

Slideshow - starts a slide show of all pictures in the album;

Edit - to edit the selected picture. When the picture is zoomed in, drag the picture to view parts that are not in view. When the picture is zoomed to fit the window, drag left or right to view the next or previous picture in the album.

Rotate left or **Rotate right** to rotate the picture/photo 90° anticlockwise or clockwise;

If you tap **Crop** icon the following cropping rectangle will appear on top of the picture/photo:

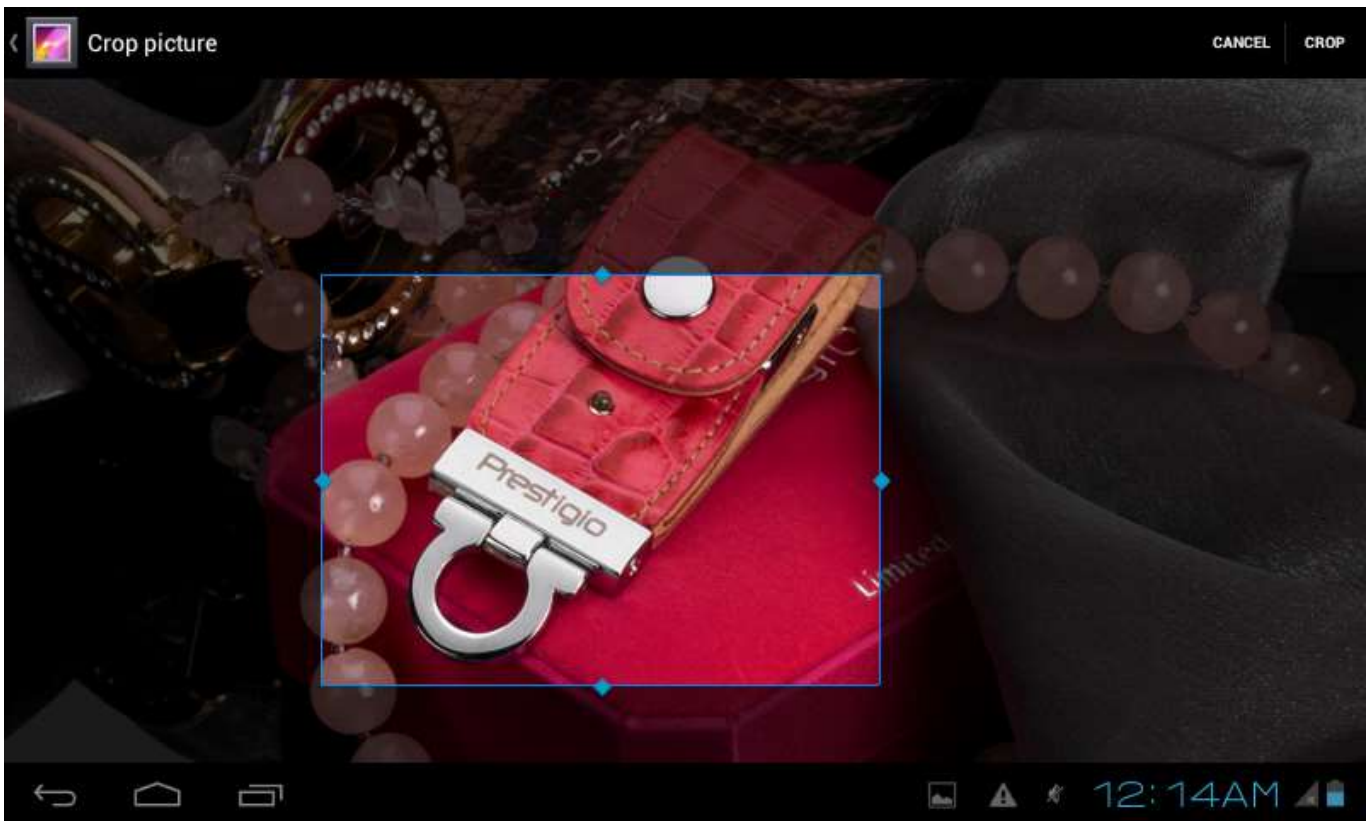

Drag from the inside of the cropping tool to move it; drag an edge of the cropping tool to resize it to any proportion; drag a corner of the cropping tool to resize it with a fixed proportions.



Tap **CROP** to save a copy of the picture as you cropped it. The original (not cropped) version remains on your SD card.

Set picture as to set the current picture/photo as wallpaper;

Details to see more details about the current picture/photo;

7.4 File Manager

Introduction to File Manager

On the Home screen tap the icon  and tap the File Manager (Explorer) icon  after to open it as follows:



File Management

In the above screen, you can navigate your storage and manage your files in the local disk and your storage card: copy/paste, delete, move and rename file and folder and send them via Bluetooth, mail or Skype.

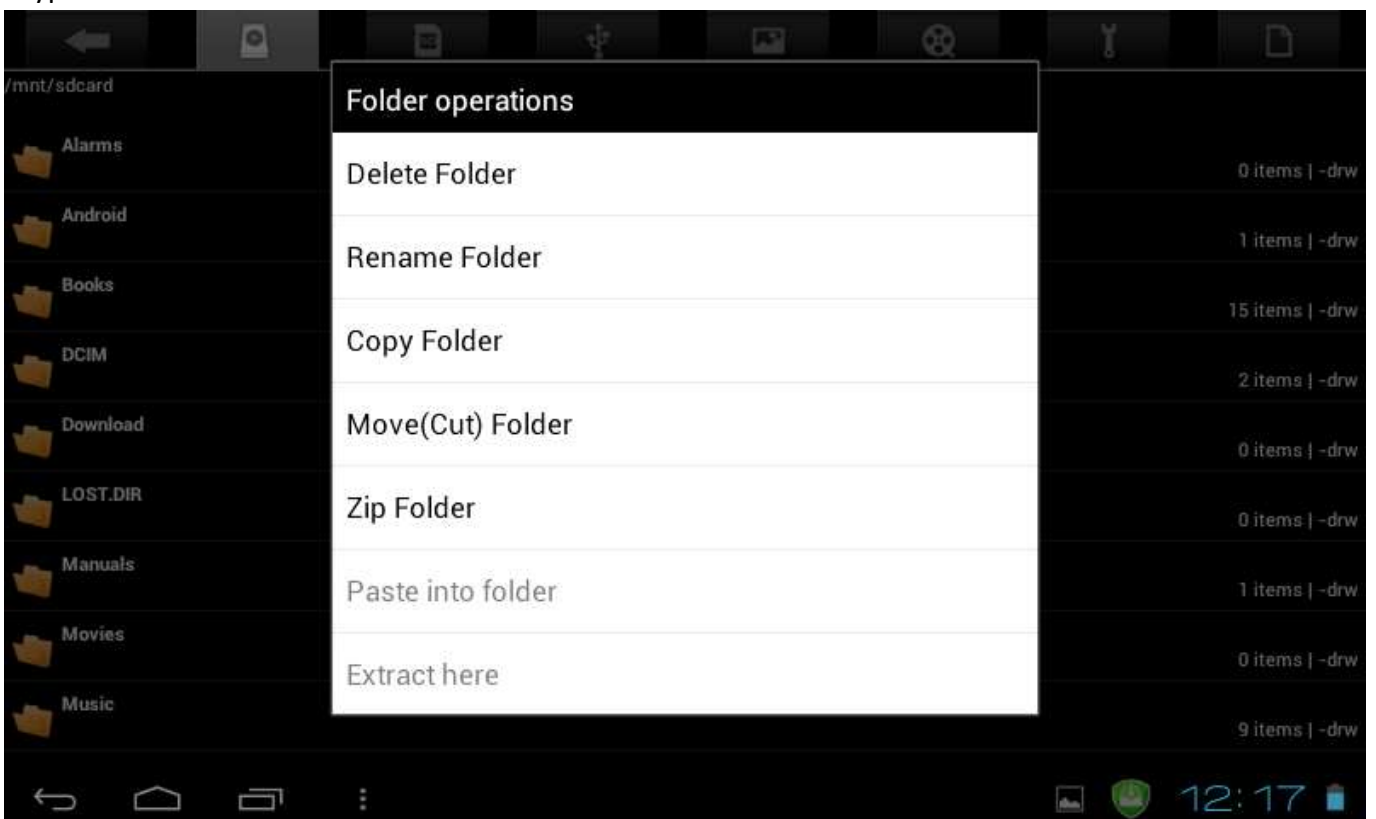

7.5 Instant Messaging tools

You can download from Google Play and install chat tools on your device such as Skype, Fring, ICQ etc.

7.6 Emails

Tap the launcher icon  on the Home screen to display all icons, tap the Email/Gmail icon to run it.



With help of Prestigio MultiPad you can:

1. Setup mail accounts
2. Create new mails
3. Receive and send mails
4. Download or open the attached files

7.7 Camera

The Camera app is a combination of a camera and camcorder. You may toggle between these two modes

by touching respective icons  and .

To take pictures and videos touch the Camera icon  on a Home or All Apps screen.

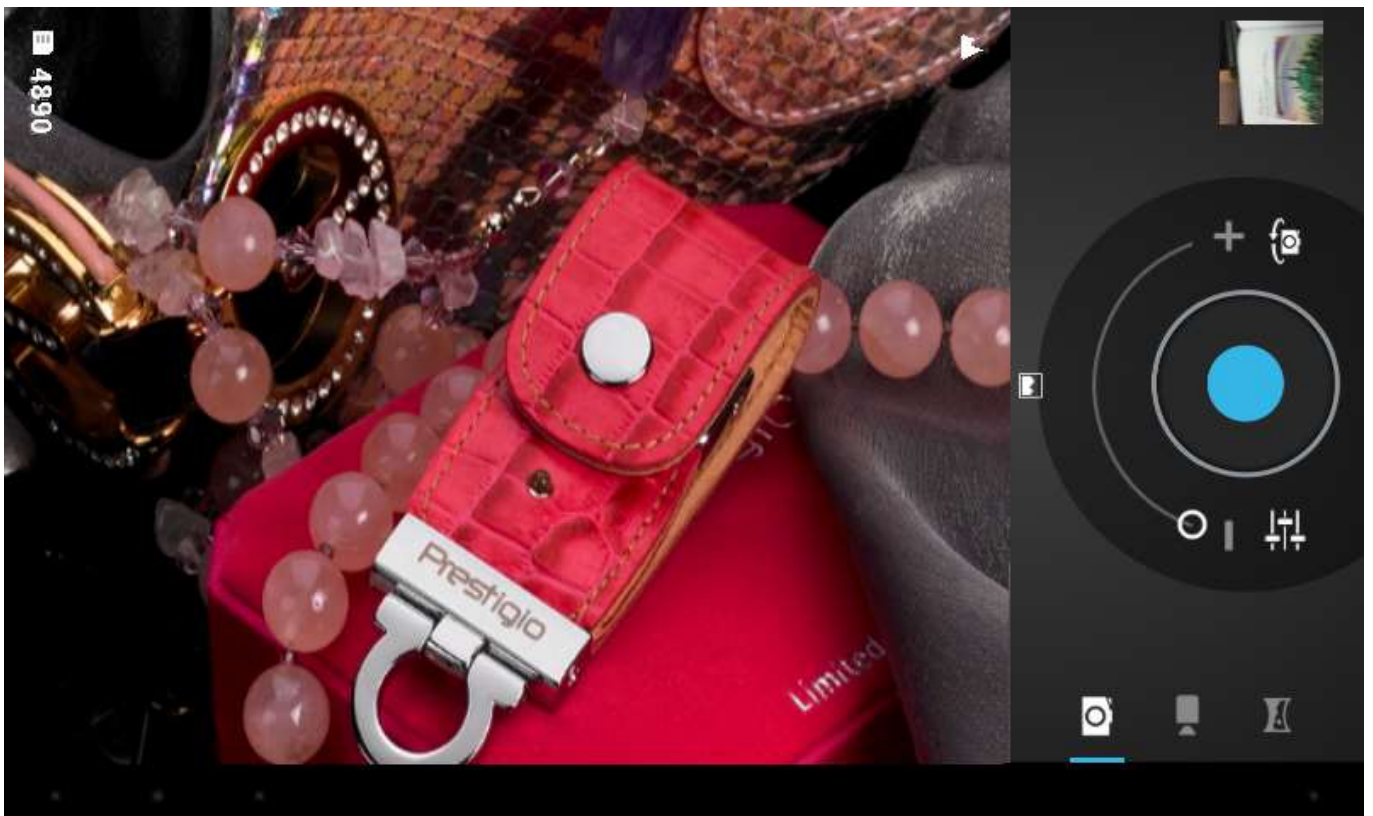

8. Prestigio preinstalled apps



Your new MultiPad contains several applications preinstalled by Prestigio to make using MultiPad more comfortable right from the box.

Following applications you can find in all apps list by touching  icon on the Home screen:

| Application | Description |
|---|--|
|  eReader Prestigio | Prestigio branded bookstore. You can download and read Your favorite books are here here. Please read a detailed eReader Prestigio User manual provided (Appendix A) |
|  Facebook | Stay always connected with Your friends and family with Facebook social network |
|  Twitter | Your favorite Twitter app. now always with You. Create and send Your messages from anywhere. |
|  OfficeSuite | Increase Your productivity with mobile office application. |
|  Angry Birds Chess Free | And games, of course. Angry Birds – favorite game of millions! Classic Chess – game of all times. |
|  SugarSync | Let Your important files synchronized from everywhere! It is a client for cloud storage service. |
|  File manager | Manage Your files with this application. |

9. Settings

9

Control and customize your device settings on the Settings screen.

To open the Settings screen, simply tap the Settings icon  on the Home screen.

You can scroll on the screen upwards/downwards to check the rest setting items.

9.1 Wireless & networks

Configure your device's wireless connections, e.g., Wi-Fi, Virtual Private Networks, or set the options for Portable hotspot.

Wi-Fi

To turn on/off Wi-Fi, simply slide your finger rightward/leftward on the control bar.



Data Usage

Data usage menu lets you to control 2G data connections, to monitor total usage by network type and application and then set limits if needed.

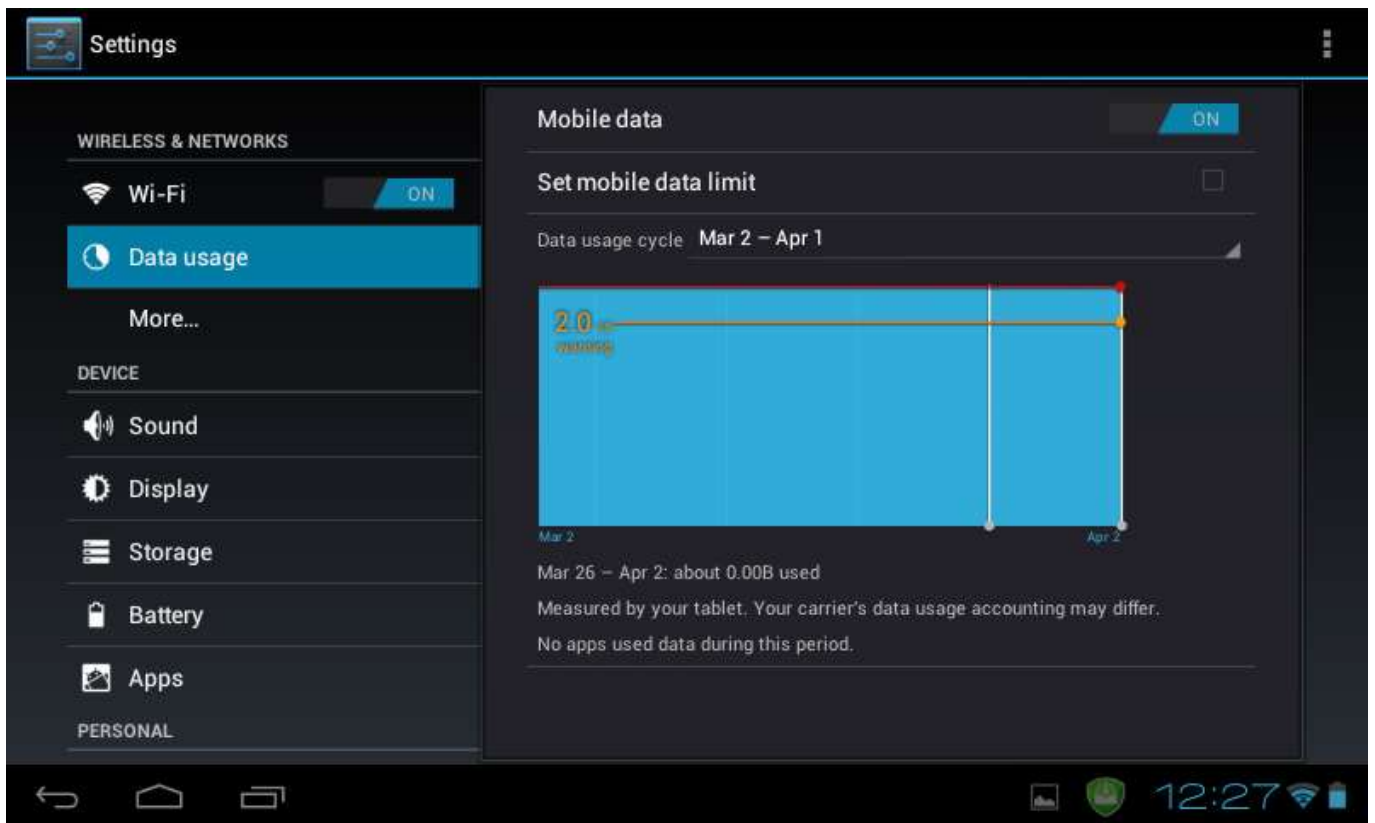

More...

This menu allows you to setup Virtual Private Network (VPN) or enable Wi-Fi hotspot.



9.2 Sound

Set the device and notification ring tones, volume adjust, system sounds.



Volumes

To adjust the volume for media, ringtone, notification and alarms:

1. Tap Settings > Sound > Volumes;
2. Drag the control bar leftwards/rightwards to turn down/up the volume for media and notification;
3. Tap **OK**.

Ringtones & Notifications

To set a notification ringtone:

4. Tap Settings > Sound > Default notification
5. Tap a ringtone to listen it
6. Enable a ringtone as notification ringtone by tapping **OK**.

System

Use the checkers to enable/disable Touch sounds or screen lock sound

9.3 Display

Set the screen brightness, auto-rotate option, wallpaper, screen timeout and font size.

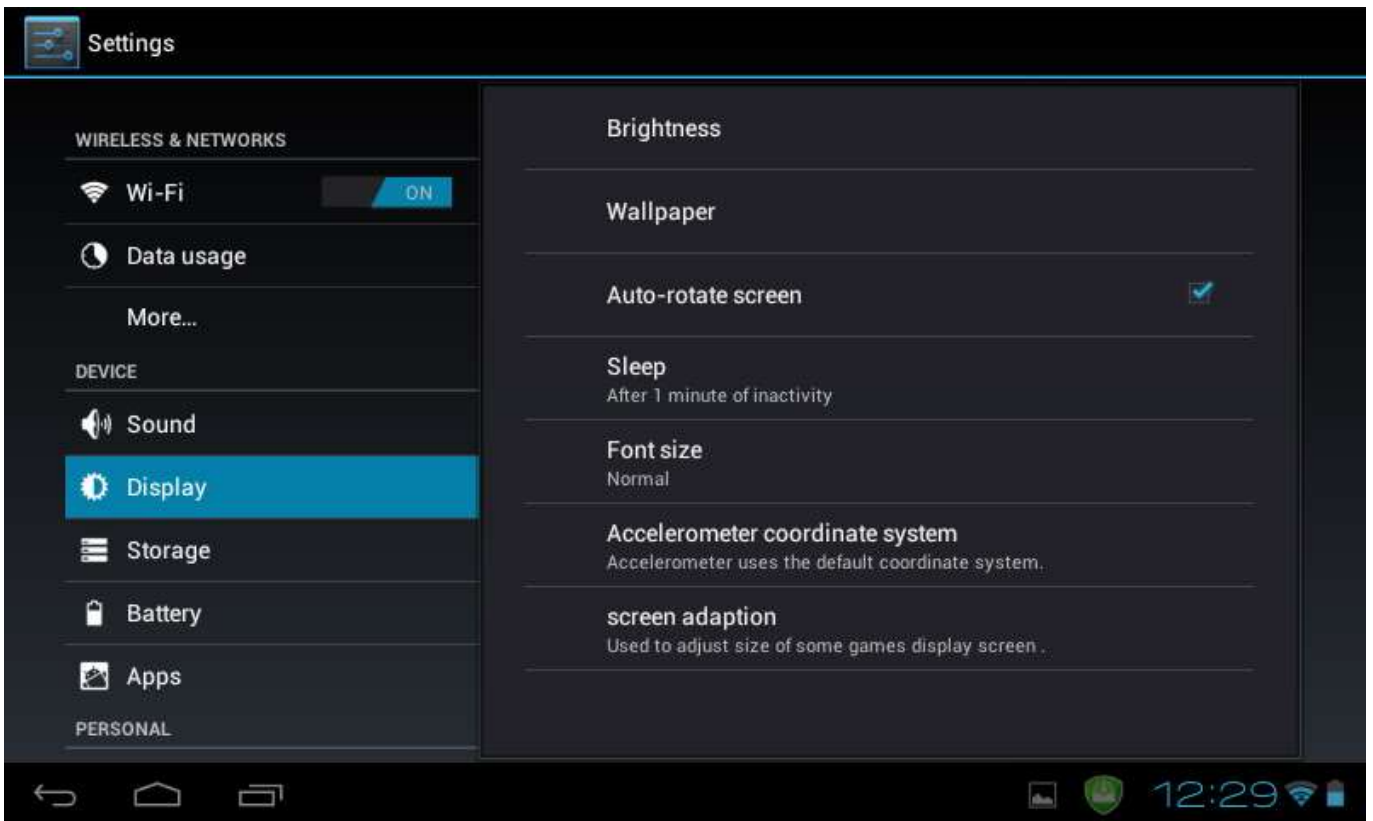

Brightness

Use the slider to set a brightness level you want at all times when using MultiPad. For the best battery performance, use the dimmest comfortable brightness.

Wallpaper

Tap to select source of wallpaper and set wallpaper for the device.

Auto-rotate screen

Check to enable/disable automatic switch of the orientation of the screen when you turn the device.

Sleep

Open a dialog where you can set how long to wait after you tap the screen or touch a button before the screen darkens. For the best battery performance, use the shortest convenient timeout.

Font size

Open a dialog where you can set font size.

9.4 Storage

Check the usage condition of the storage space on the internal & external storage card. You can erase all data on the SD card and unmount the external SD card for safety removal.

Unmount the SD card: Tap **Settings > Storage > Unmount SD card > OK**.

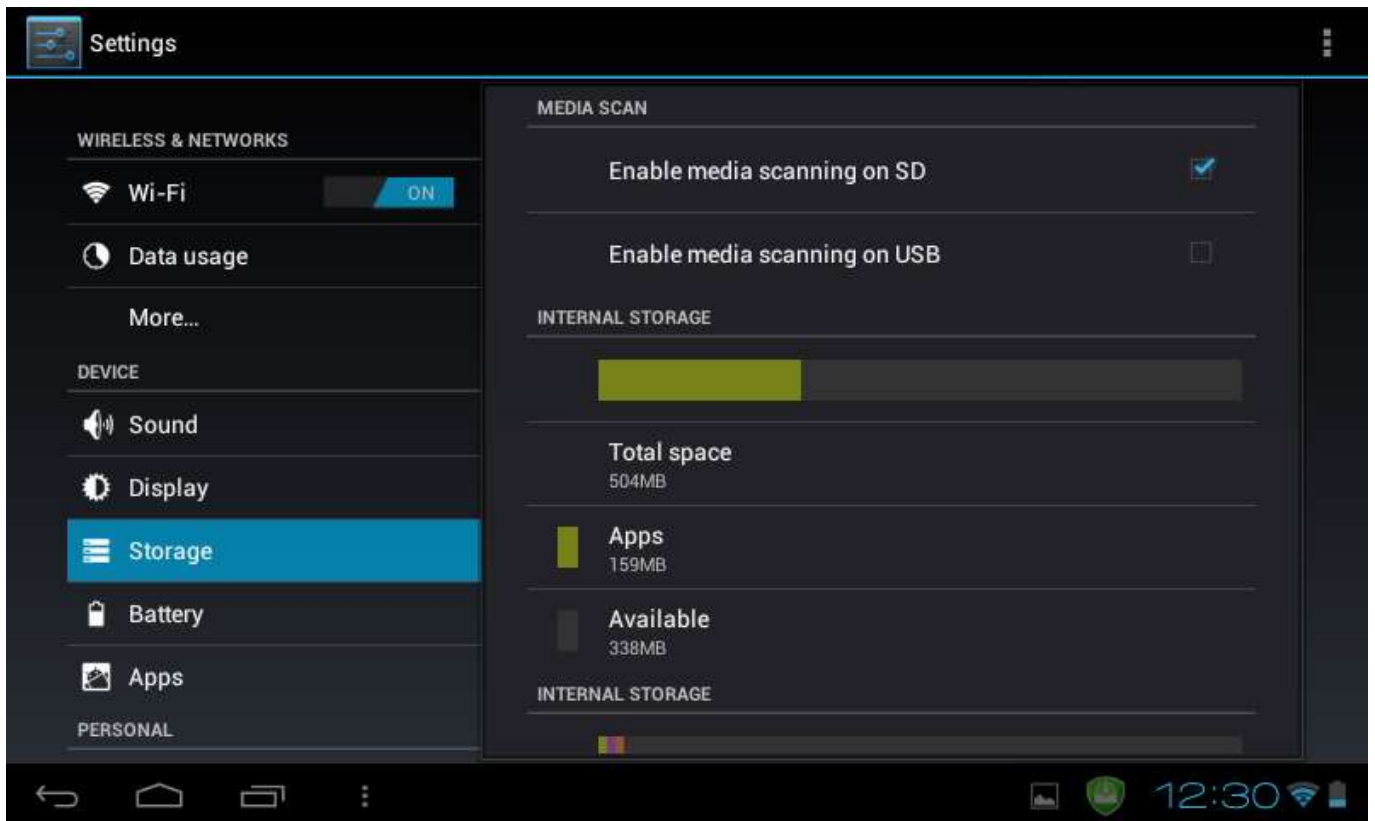

9.5 Apps

Manage applications and installation of new programs.

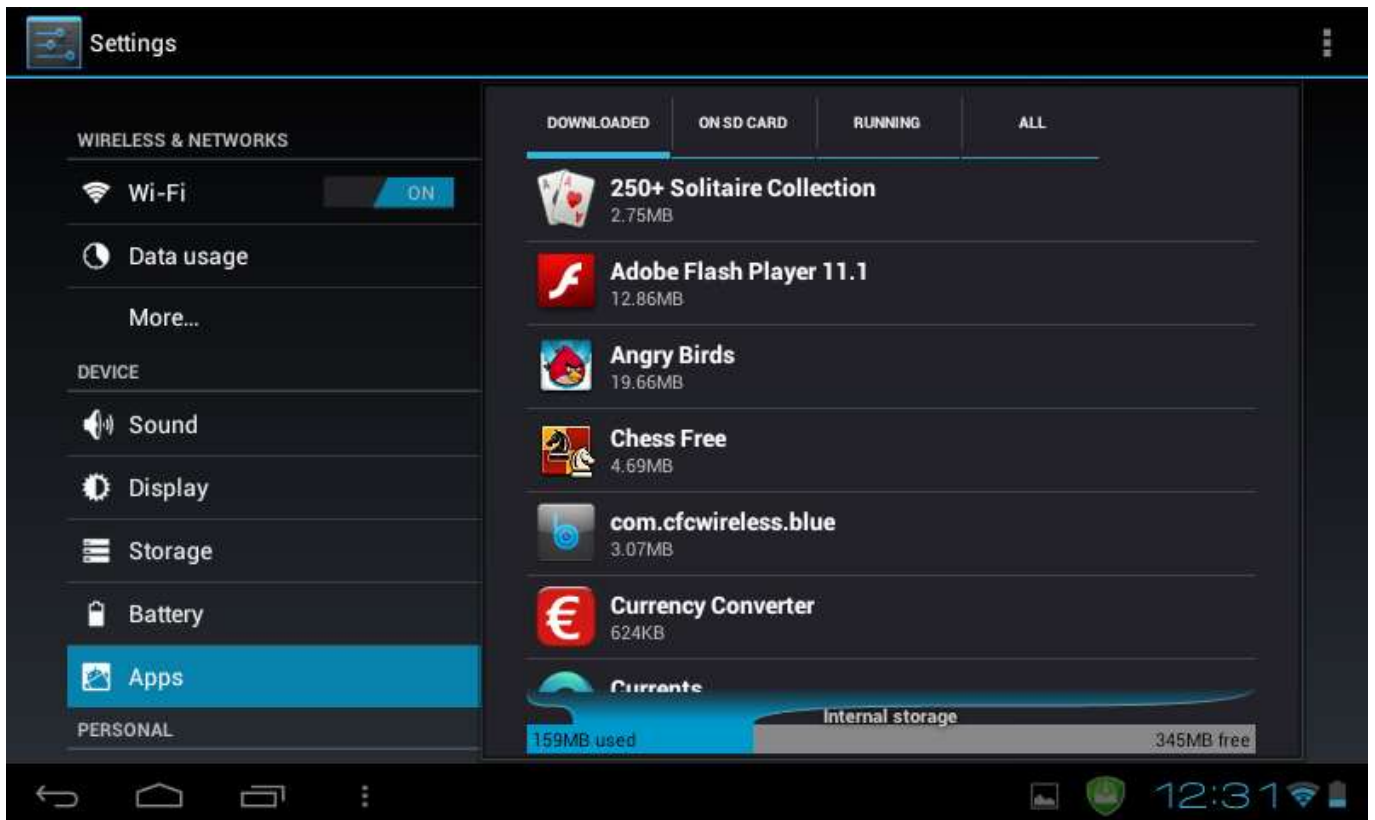

Apps

Open a list of all the applications and other software installed on your MultiPad, along with their sizes. By default, only downloaded applications are shown, and they are sorted in alphabetical order. Touch  and tap **Sort by size** to display applications in order by size. Tap an application to open its Application Info screen.

To manage and /or remove downloaded applications, tap Settings > Apps > Downloaded.

Running services

To check and control running service, tap Settings > Apps > Running.

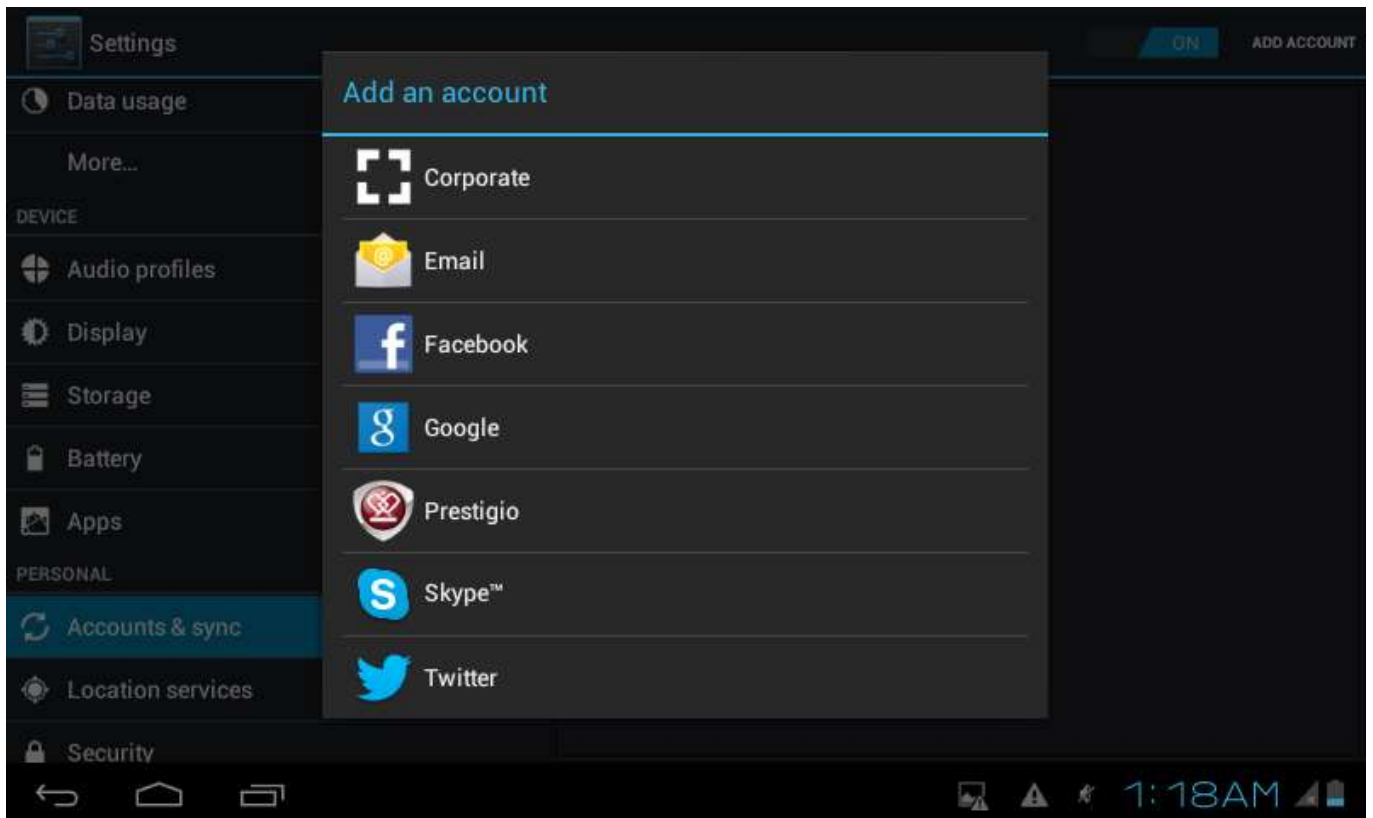

9.6 Accounts & Sync

Log in or out from your social network accounts, Google Account, and Exchange ActiveSync account. You can also manage synchronization and other settings for your accounts.

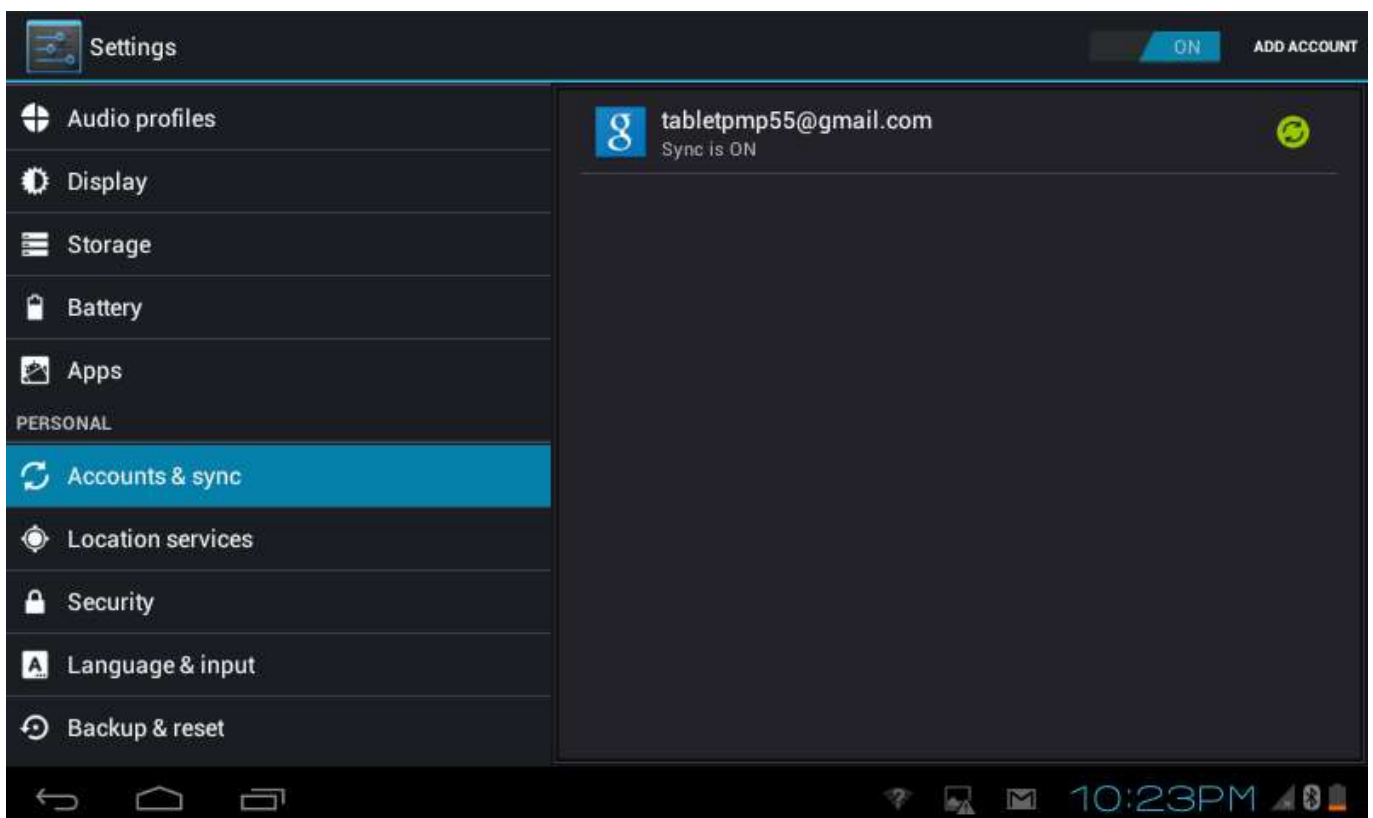

Tap **ADD ACCOUNT** in the above screen to add new accounts by following onscreen instructions. Tap the icon  to prompt the following screen to manage your accounts:



Check  to turn on/off data synchronization, touch the menu icon  and then tap **Remove account** to remove the selected account from your device.

9.7 Location service

Enable applications using data from sources such as Wi-Fi and mobile networks to orientate your location and improve Google search results via check the options.

9.8 Security settings

Set the screen lock mode and owner information, encrypt your device, manage password and administrate your device.



To personalize the screen lock mode of your device, tap **Settings > Security> Screen lock**

The following options are possible to choose:

- **None** – this one means no screen lock will be enabled at sleep/resume/system on step
- **Slide** – you have to slide the screen lock button to one of directions (unlock-camera-Google web-page)
- **Face Unlock** - Face Unlock lets you unlock your phone by looking at the screen. After you set it up, look under **Settings > Personal > Security** for two additional settings: **Improve face matching** and **Liveness** check. Use these to make Face Unlock more reliable and secure.
- **Pattern** - lets you draw a simple pattern with your finger to unlock the phone. This is slightly more secure than Face Unlock.
- **PIN** – **If you choose this option it will require you to enter 4 or more numbers to unlock the Multipad**
- **Password** - This is the most secure option, as long as you create a strong password.

[Note]: There is no way to recover password/pin/pattern lock, in case you forget the correct logon info. The only way to erase this lock is to perform complete device reset or, e.g. firmware reinstallation. All user's apps and files will be lost in this case.

Owners Info

It's possible to show owner's info on lock screen. Choose this option in this menu and Type the text to display on the lock screen in the text box below.

Passwords

Check the box if you'd like to make the passwords visible while you enter them.

Device administration

You may view or deactivate device administrators in this menu, as well as enable installation of apps from unknown sources (other

Unknown sources

Check to permit installation of applications that you obtain from web sites, email, or other locations other than Google Play Store.

9.9 Language & input settings

Set the operating system language and region by touching the setup icon . You can also set onscreen keyboard options.

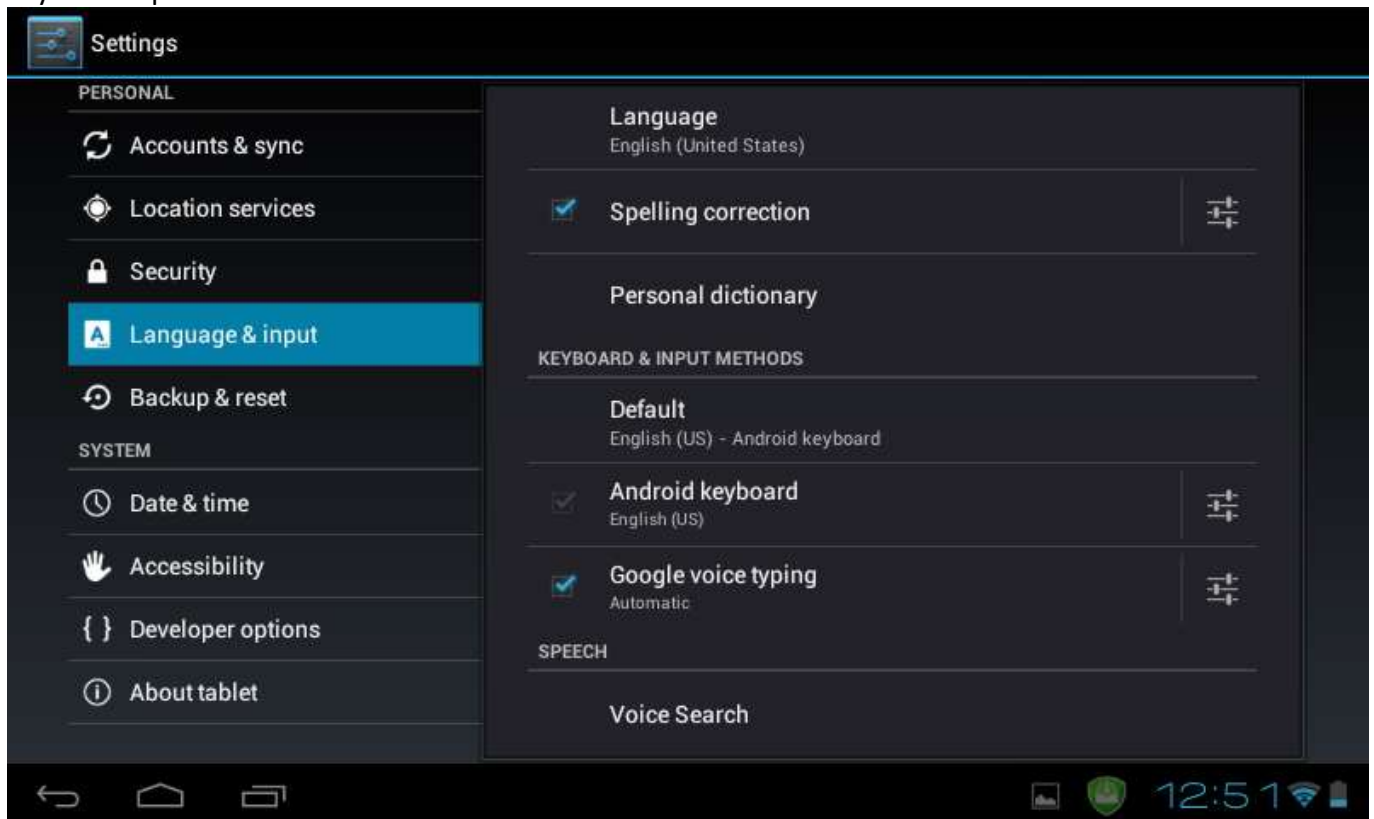

9.10 Backup & reset

You can enable or disable the automatic backup feature of the device and reset the device.

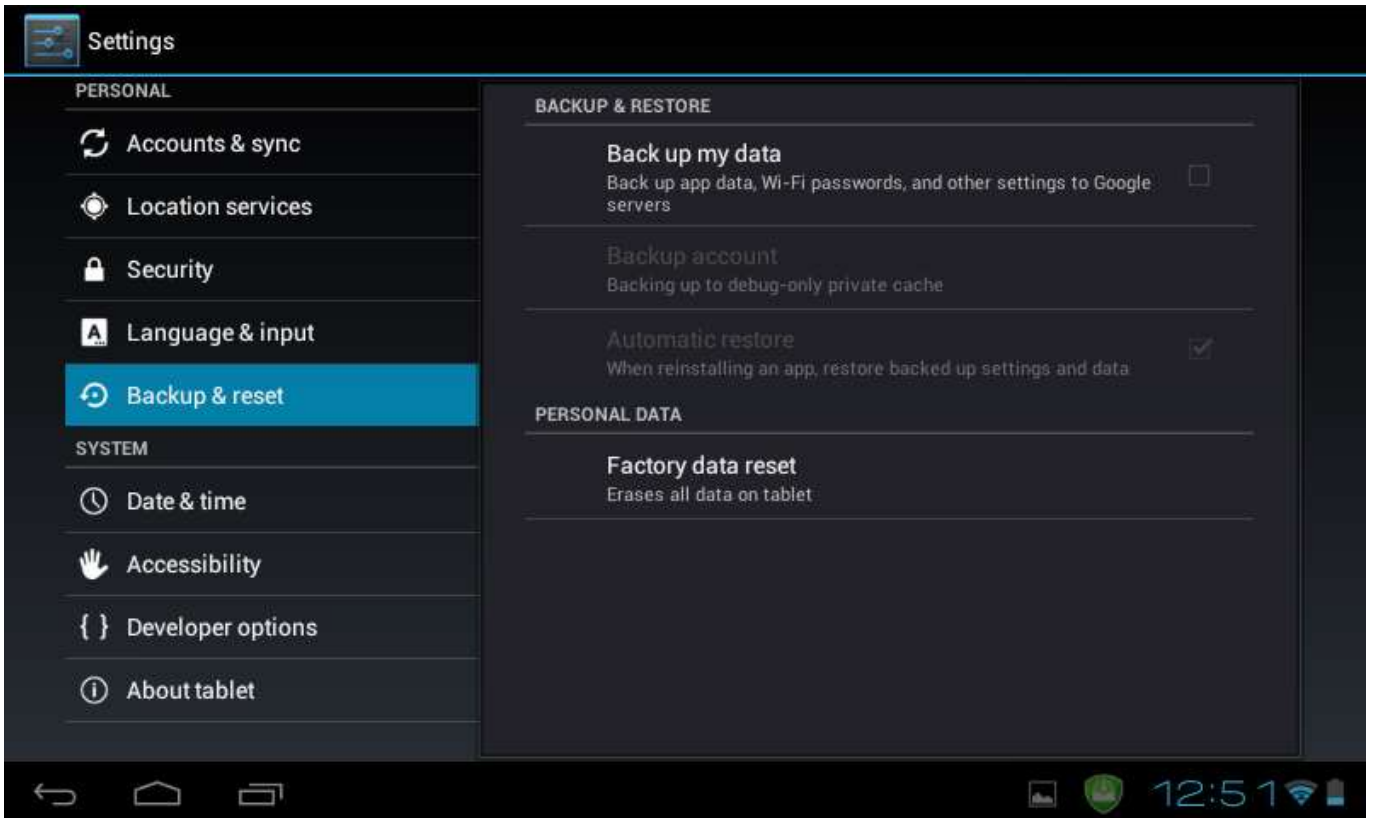

[Note]: after factory data reset, you personalizing settings and the installed third-party applications will be removed from your device. Before restoring default settings, it is suggested to backup data/applications you want and remove your storage card safely in case of data loss or damage during restoring factory default settings.

9.11 Date & Time setting

Set the date and time, time zone, and date or time format. To turn off auto time synchronization simple unmark it and you will be able to manually change time settings.



9.12 Accessibility

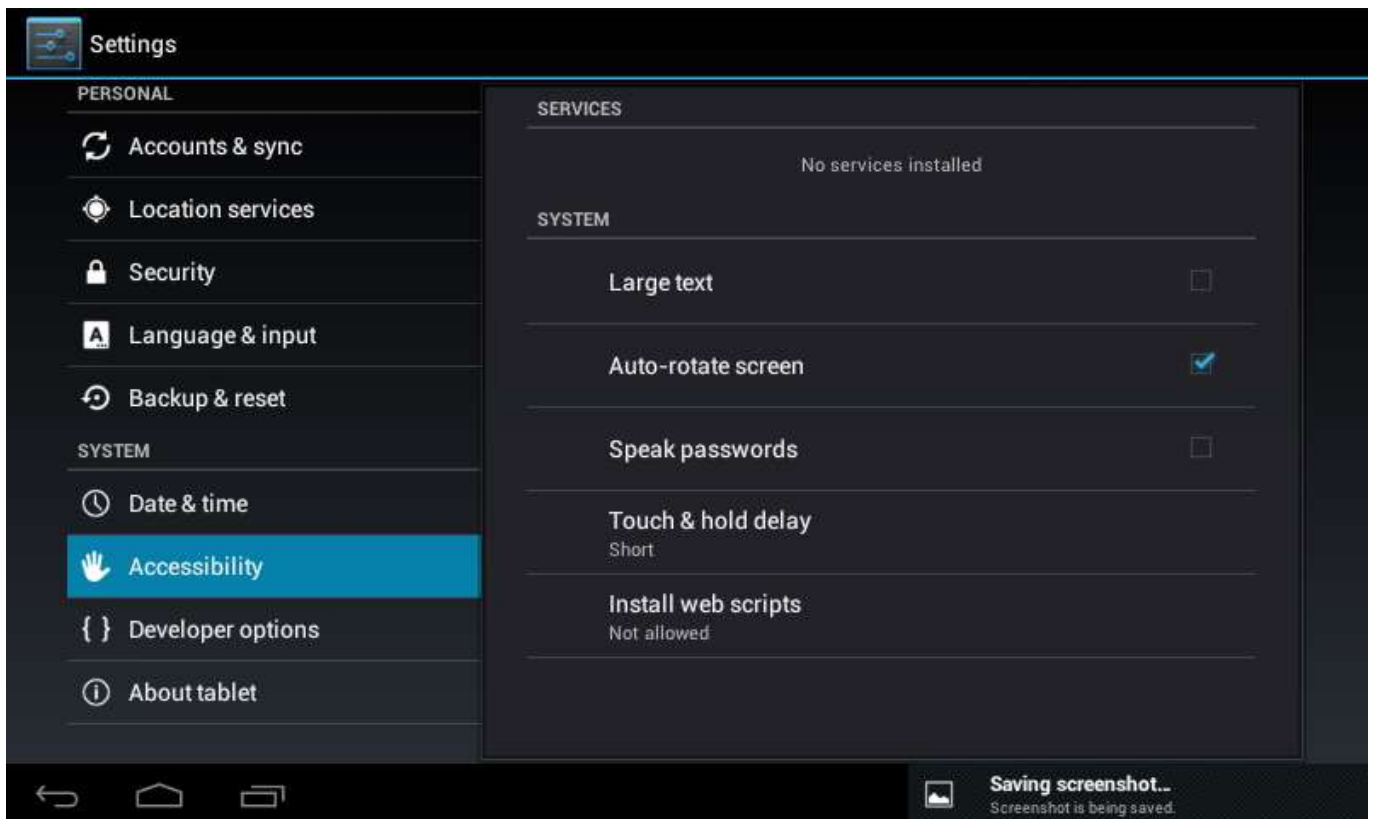

Speak passwords: check to enable speak password

Touch & hold delay: 3 levels of delay when touch and hold widget or icon are available – Short, Medium,

Long. It regulates the duration of object hold till further actions.

9.13 Developer options

You can set the USB debugging mode, select screen stay awake while charging and so on. And you can also manage user interface and apps.



USB debugging: Check to permit debugging tools on a computer to communicate with your MultiPad via a USB connection.

Stay awake: Check to prevent the screen from dimming and locking when the MultiPad is connected to a charger or to a USB device that provides power. Don't use this setting with a static image on the MultiPad for long periods of time, or the screen may be marked with that image.

Allow mock locations: Check to permit a development tool on a computer to control where the MultiPad believes it is located, rather than using the internal methods for this purpose.

9.14 About tablet

View the device status such as the network type, battery power level, and network name. You can also check the battery use of individual applications or view the legal information and firmware version (Build number; symbols vx.x.x) of your MultiPad.



10. Troubleshooting

10

10.1 Forced shutdown

Use a paper clip to press the reset button (marked as “reset” on a side edge of the MultiPad, close to USB port) and the device will be forced shutdown. This operation might cause data loss though, so please backup important information on a regular basis.

10.2 Restore default settings

To restore the factory default settings, you can tap **Settings > Backup & reset> Factory data reset**.

Warning: data of your Google account, your personalized settings, and installed applications will be removed from your device once you execute factory default settings, so please make a careful decision whether to restore default settings. Before restoring default settings, it is suggested to backup data/applications you want.

10.3 System updating

After system update/upgrade, it may occur that the installed third-party applications cannot run or there is data loss or damage to the apps. This is normal phenomena rather than a system fault. You just need to download and install the third-party applications again into the device. It is recommended to backup data of the third-party applications before system update/upgrade. Please note, that Prestigio provides OTA (Over-the-Air) update service to its customers. You may turn on/off automatic updates and perform a manual check in the following screen accessible via Settings-About Device-System updates:

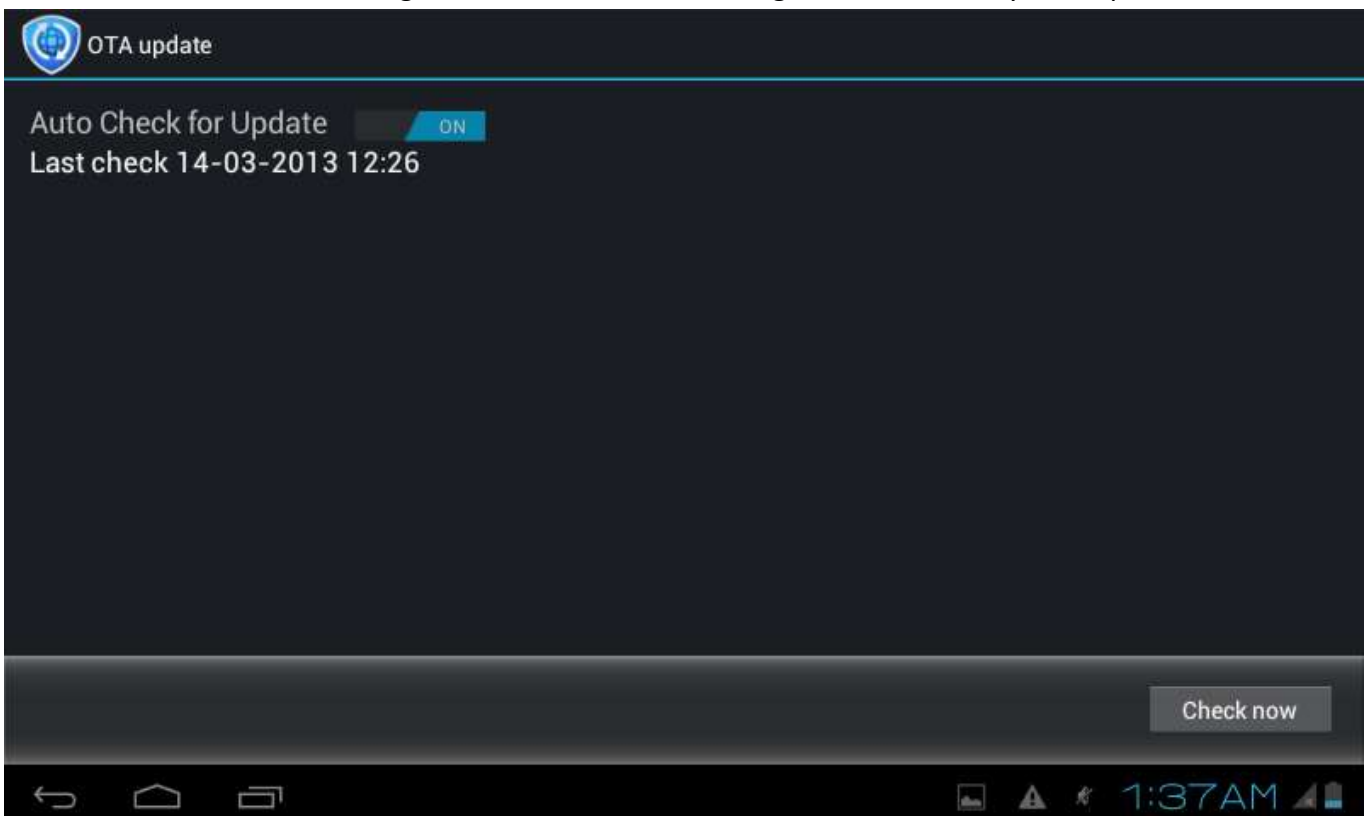

11. Glossary



Android 4.0 (Ice Cream Sandwich) - operating system for Tablet PCs and smartphones based on Linux kernel;

Google Play Store – online store with software for Android OS;

Google Account - pre registered user account for having access to the Google branded services and registration of MultiPad;

MultiPad – Prestigio trademark for Tablet PC devices;

Gmail – Google branded e-mail client;

Widgets – simple programs on the Tablet PC desktop for showing different information or shortcuts to connected installed software.

eReader Prestigio Manual

1. Launching the application.

Open list of applications or main desktop window to find eReader Prestigio icon  Tap on it to start application. Please, wait until spinner in the right top corner disappears.



While loading application will check the default folder for the available content (mnt/sdcard/Books) and display it on the shelves.

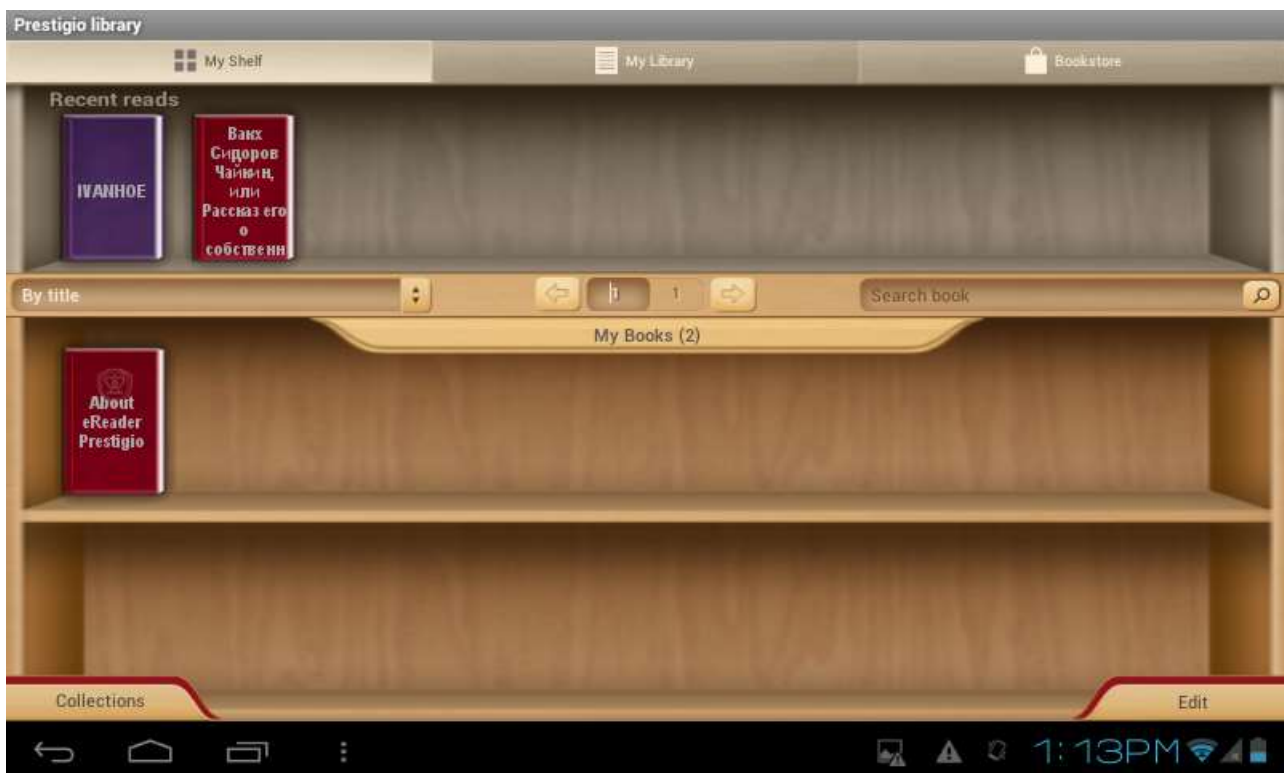

Some of the content is already preloaded on the factory and divided by languages for your comfort use.

Tap “My books” to open a list of preset folders and choose the one that corresponds to your language. Other collections can be deleted through Edit option.

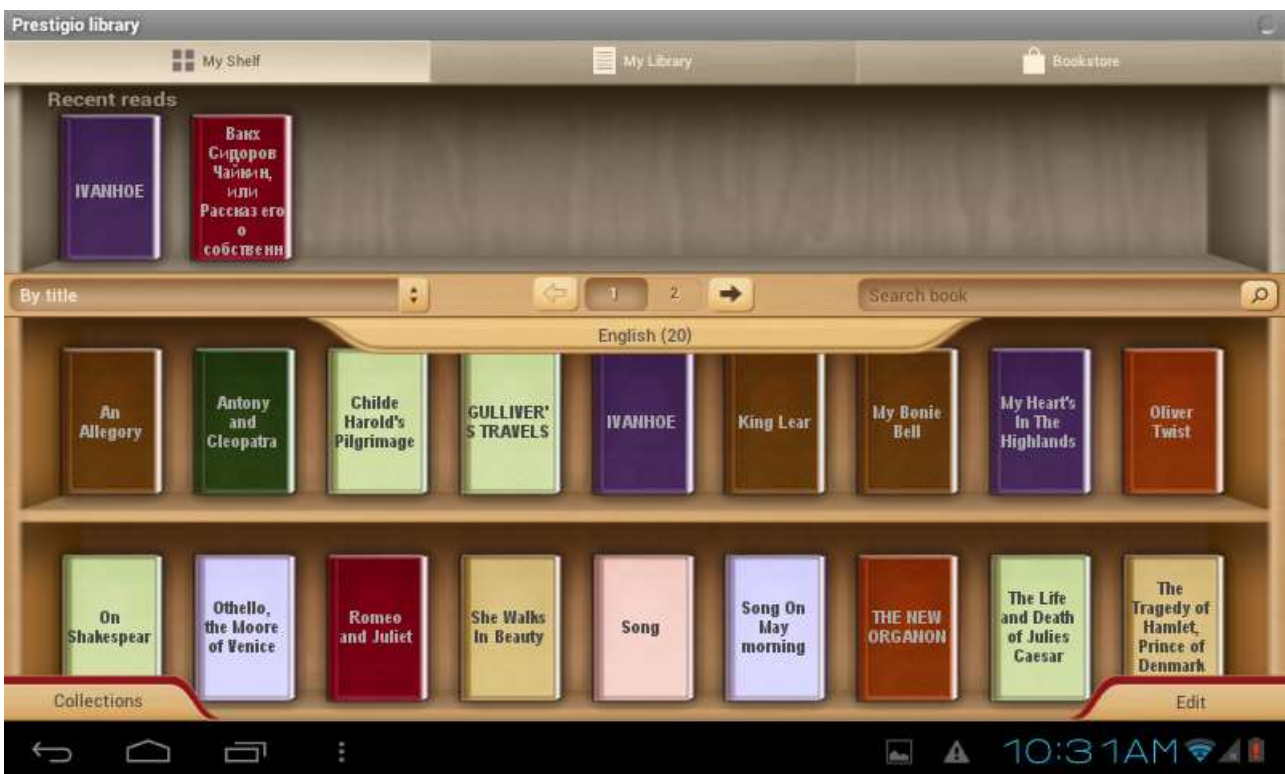

2. Main Control panel.

Settings can be called from the notification bar . Use opened options to make a quick Search, Refresh your content or Enter in Settings.

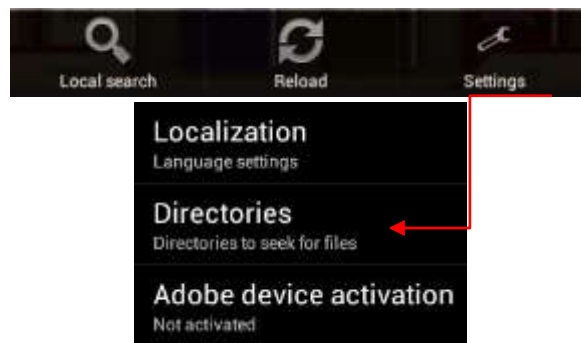

Localization. Set a custom language for your application that can be different from the Android system language.

Directories. Set any custom directory from which books will be available on the shelves.

Adobe device activation. Set Adobe Id to allow working with Adobe DRM protected books.

3. Navigation in main sections.



My Shelf is graphic presentation of the books content and its control.

My Library is the File tree and automatic grouping of the books between several assigned categories: Collections, Favorites, Recent.

Bookstore is the online shop of the books proposed by Prestigio to their customers in 22 languages with the possibility to Search and purchase any book directly from application.

4. Content control bar.



- 1 ■ Sort of the current shelves by title, author name, favorites or recently added
- 2 ■ Pagination block. Go to the next shelf in the frame of the same Collection or type a number of a shelf if you have more.
- 3 ■ Search a book with its title or its author's name. Enough to type part of the name to start Searching. Found books will be shown on the shelf. To return to the collection view it's necessary to empty search bar and press done.
- 4 ■ Collections list. Application works with folders if you already have your own library on the PC you can copy to a Prestigio e-book reader or create markers on any book

5. Work with the Collections.

“My books” contains all the books from the selected directory. It’s a default collection that can’t be removed or renamed.

Press on “My books” or “Collections” to start navigation in the list of preset or preloaded collections.

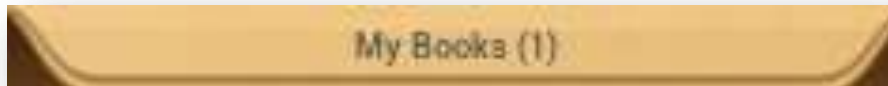

List of the collections can be edited through Edit or Add new button.



Edit. Option allows you renaming collections or deleting any selected with a marker collection. Delete the collection doesn’t mean that books will be erased physically from the device.

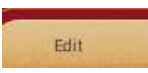

Any book or a group of the books can be moved from one collection to another or deleted from the device and collection.

Select  on the main shelf to start working with books.

A new control bar will be available.



Move - Allows to move a book from a collection to another chosen collection.

Delete - Remove all selected books from the application and device.

Select all - Option will mark all books not only on the opened shelf but on all other shelves of a collection. Be very careful as it also allows to Delete all books from the collection.

Done -Tap when all operations with the books on the shelves are finished.

When Edit option is activated on the shelf it's possible to mark any book on any shelf just by clicking on a cover. Then other options will help to Move or Delete chosen content.

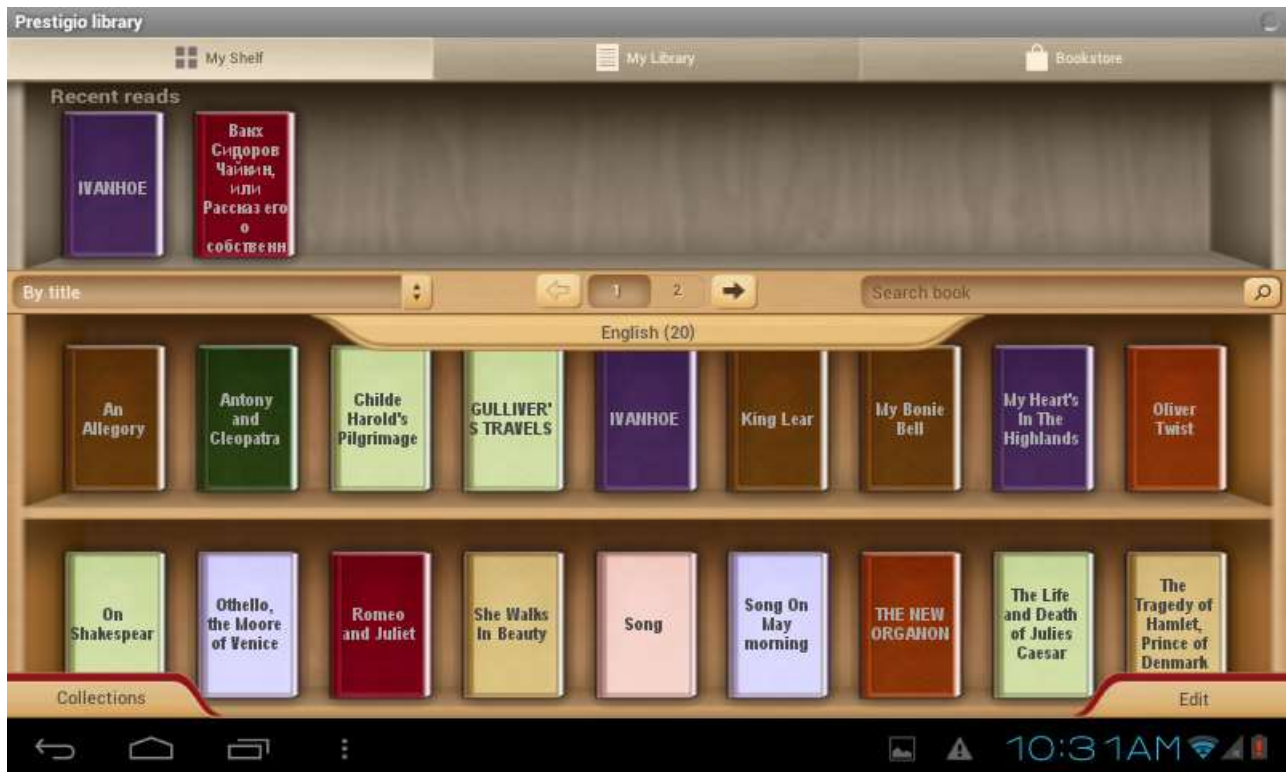

6. Reading a book.

To read a book it's enough to press on its cover on a shelf.

Settings options can be opened via Context menu icon .



Book info. Display information about the book

Bookmarks. Return to the most interesting places in a book with a bookmarks made.

Night. By default any book is read in Day mode (white backend + black font). It can be easily switched to a night mode to keep user's eyes in safe.

Search. Allows to find a word or expression in the text of a book.

Settings. Customization option to get the reading experience in a comfortable way: Appearance, Text size, Text font, Colors and Wallpapers, Scrolling and Indicators.

More... Open navigation panel to jump easily to any book page, adjust Brightness or set Font size with one touch.

Any read book will appear on the main screen in Recent read section from the left side.

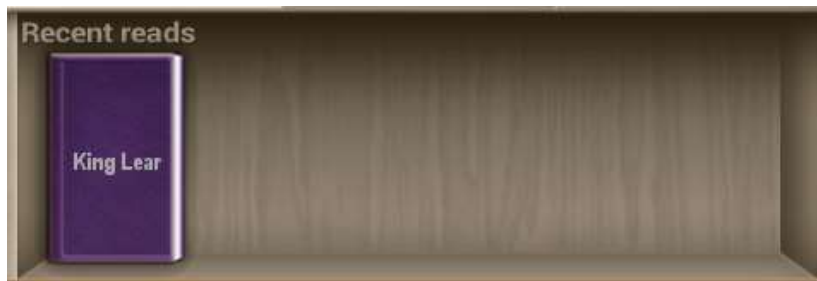

Press on the book from the shelf to continue reading from the last opened page.

7. Work with Bookstore.

Bookstore in the device is available in the form of OPDS catalog: simple form of the books list that mirrors www.ebooks.prestigioplaza.com web-shop.

Catalog can be navigated like a tree with 2 main categories: Themes & genres and Authors.

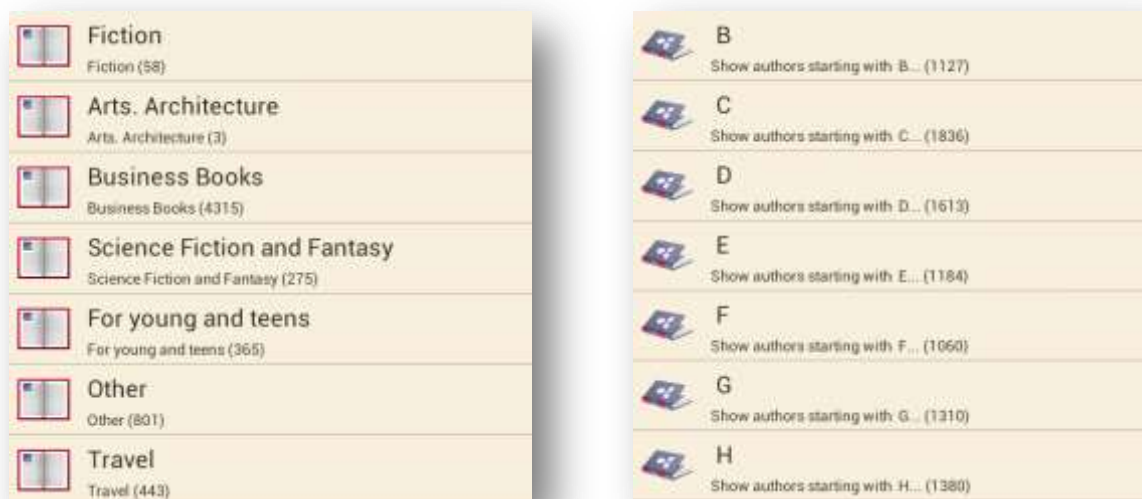

Continue navigation until you find a book or a genre that might be interesting for you.

To search for a specific author or a book use the option **Network Search**.

Refresh catalogs can be used in a case when first connection to Bookstore was made without Internet connection.



Found book will be displayed with a detailed info and price if applicable. Free books will have **Download** button instead of **Buy...**

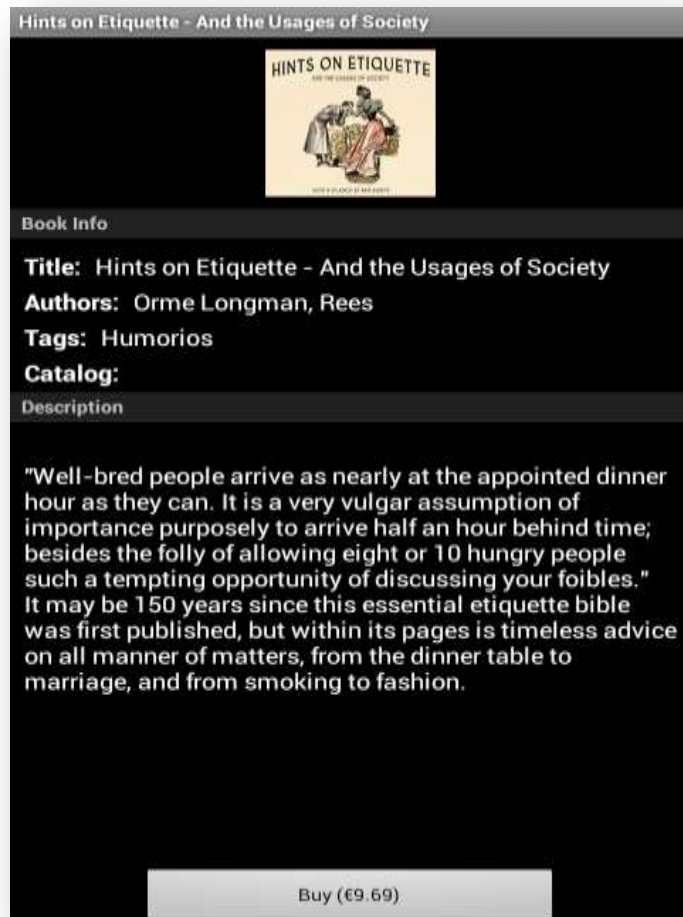

To purchase a book press **Buy...** and then **Sign in** or Register My Prestigio account. If account is active and balance is enough to make a transaction then download will be started automatically.

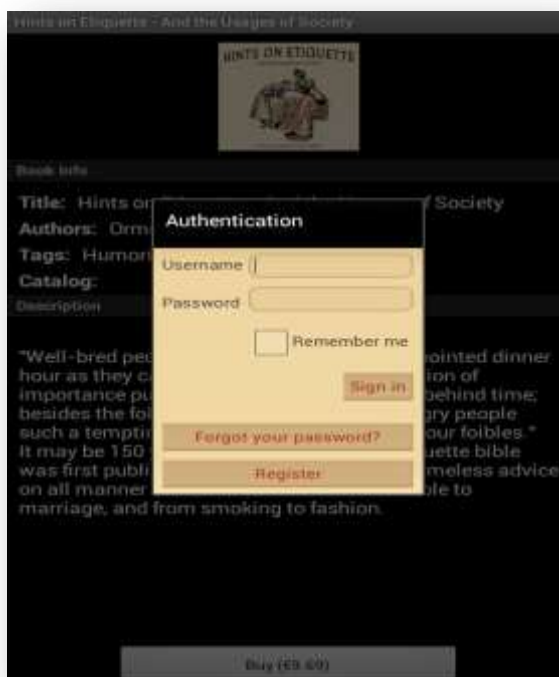



Attention: in case of unstable Internet connection or if download didn't start, please, check **My orders** in the application or visit your **Prestigio Cabinet** on the web-pages to check the order and download a book separately.

Prestigio Cabinet can be found on the main screen of OPDS catalog in the bottom line.



My account shows up only to sign in users.



My Prestigio will help you to control your balance, personal info and orders without going into Prestigio web site.

Overview. General information about account holder and his/her balance.

Personal Info. Login, first/last name, country of residence and phone number. Also option to Change password.

Language. Language of the books preferred for reading.

My Balance. Quick option to refill balance and

continue buying books with one touch only.

My orders. List of all transactions made by a user in application or at Prestigio site www.ebooks.prestigioplaza.com.

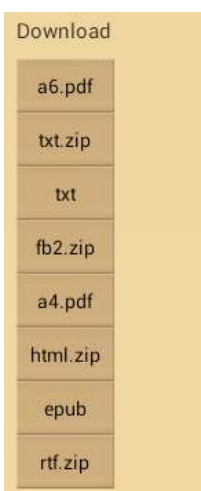

Once download links are not expired it's possible to get a book from an order details to a mobile device. Downloaded book will be available in "My books" after Refreshing collections or can be found in section **My Library** using File tree.