

PENTAX

Digital Camera

PENTAX Q10

Operating Manual

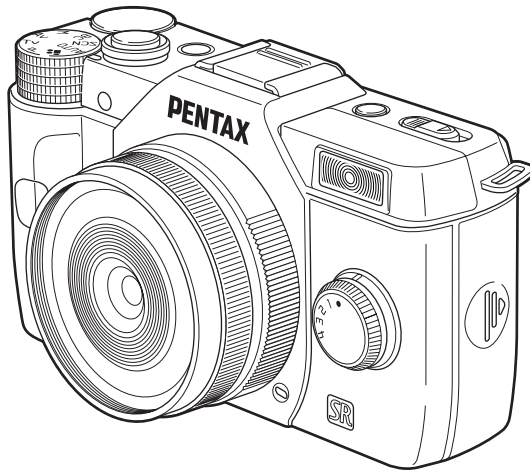

To ensure the best performance from your camera, please read the Operating Manual before using the camera.

Thank you for purchasing this PENTAX Q10 Digital Camera. Please read this manual before using the camera in order to get the most out of all the features and functions. Keep this manual safe, as it can be a valuable tool in helping you to understand all the camera's capabilities.

Lenses you can use

Lenses that can be used with this camera are Q-mount lenses.

Regarding copyrights

Images taken with the PENTAX Q10 that are for anything other than personal enjoyment cannot be used without permission according to the rights as specified in the Copyright Act. Please take care, as there are cases where limitations are placed on taking pictures even for personal enjoyment during demonstrations, performances or of items on display. Images taken with the purpose of obtaining copyrights also cannot be used outside the scope of use of the copyright as laid out in the Copyright Act, and care should be taken here also.

Regarding trademarks

Microsoft, Windows and Windows Vista are registered trademarks of Microsoft Corporation in the United States of America and other countries.

Macintosh, Mac OS, and QuickTime are trademarks of Apple Inc., registered in the U.S. and other countries.

Intel, Intel Core, and Pentium are trademarks of Intel Corporation in the U.S. and other countries.

SDXC Logo is a trademark of SD-3C, LLC.

This product includes DNG technology under license by Adobe Systems Incorporated. The DNG logo is either a registered trademark or trademark of Adobe Systems Incorporated in the United States and/or other countries.

HDMI, the HDMI logo and High-Definition Multimedia Interface are trademarks or registered trademarks of HDMI Licensing, LLC in the United States and/or other countries.

All other brands or product names are trademarks or registered trademarks of their respective companies.

This product supports PRINT Image Matching III. PRINT Image Matching enabled digital still cameras, printers and software help photographers to produce images more faithful to their intentions. Some functions are not available on printers that are not PRINT Image Matching III compliant.

Copyright 2001 Seiko Epson Corporation. All Rights Reserved. PRINT Image Matching is a trademark of Seiko Epson Corporation. The PRINT Image Matching logo is a trademark of Seiko Epson Corporation.

This product is licensed under the AVC Patent Portfolio License for the personal use of a consumer or other uses in which it does not receive remuneration to (i) encode video in compliance with the AVC standard ("AVC video") and/or (ii) decode AVC video that was encoded by a consumer engaged in a personal activity and/or was obtained from a video provider licensed to provide AVC video. No license is granted or shall be implied for any other use. Additional information may be obtained from MPEG LA, L.L.C. See <http://www.mpegla.com>.

To users of this camera

- Do not use or store this camera in the vicinity of equipment that generates strong electromagnetic radiation or magnetic fields. Strong static charges or the magnetic fields produced by equipment such as radio transmitters could interfere with the monitor, damage the stored data, or affect the camera's internal circuitry and cause camera misoperation.
- The liquid crystal panel used for the monitor is manufactured using extremely high precision technology. Although the level of functioning pixels is 99.99% or better, you should be aware that 0.01% or fewer of the pixels may not illuminate or may illuminate when they should not. However, this has no effect on the recorded image.
- There is a possibility that the illustrations and the display screen of the monitor in this manual are different from the actual ones.
- In this manual, SD Memory Cards, SDHC Memory Cards and SDXC Memory Cards are referred to as SD Memory Cards.
- In this manual, the generic term "computer(s)" refers to either a Windows PC or a Macintosh hereafter.
- In this manual, the term "battery(ies)" refers to any type of batteries used for this camera and its accessories.

For Using Your Camera Safely

We have paid close attention to the safety of this camera. When using this camera, we request your special attention regarding items marked with the following symbols.



Warning

This symbol indicates that ignoring this item could cause serious personal injuries.



Caution

This symbol indicates that ignoring this item could cause minor or medium personal injuries, or loss of property.

About the Camera



Warning

- Do not disassemble or modify the camera. High voltage areas are present inside the camera, with the risk of electric shock.
- If the camera interior is exposed due to dropping or otherwise damaging the camera, never touch the exposed portion. There is a risk of electric shock.
- Do not aim the camera at the sun or other strong light sources when taking pictures or leave the camera sitting in direct sunlight with the lens cap off. Doing so may cause the camera to malfunction or cause a fire.
- Do not look at the sun or other strong light sources through the lens. Doing so may lead to a loss of eyesight or cause vision to be impaired.

- If any irregularities occur during use, such as smoke or a strange odor, stop use immediately, remove the battery or the AC adapter, and contact your nearest PENTAX Service Center. Continued use can cause a fire or electrical shock.



Caution

- Do not place your finger over the flash when discharging the flash. You may burn yourself.
- Do not cover the flash with clothing when discharging the flash. Discoloration may occur.
- Some portions of the camera heat up during use. There is a risk of low temperature burns when holding such portions for long periods.
- Should the monitor be damaged, be careful of glass fragments. Also, be careful not to allow the liquid crystal to get on your skin or in your eyes or mouth.
- Depending on your individual factors or physical condition, the use of the camera may cause itching, rashes or blisters. In case of any abnormality, stop using the camera and get medical attention immediately.

About the Battery Charger and AC Adapter



Warning

- Always use the battery charger and AC adapter exclusively developed for this camera, with the specified power and voltage. Using a battery charger or AC adapter not exclusive to this camera, or using the exclusive battery charger or AC adapter with an unspecified power or voltage can cause a fire, electric shock, or camera breakdown. The specified voltage is 100 - 240V AC.
- Do not disassemble or modify the product. This can cause a fire or electrical shock.
- If the generation of smoke or strange odor from the product or other abnormality occurs, immediately discontinue using and consult a PENTAX Service Center. Continued use can cause a fire or electrical shock.
- If water should happen to get inside the product, consult a PENTAX Service Center. Continued use can cause a fire or electrical shock.
- If you see a lightning flash or hear thunder during use of the battery charger or AC adapter, unplug the power plug and discontinue use. Continued use can cause damage to the product, fire or electrical shock.
- Wipe off the power plug if it should become covered with dust. Accumulated dust may cause a fire.
- To reduce the risk of hazards, use only CSA/UL certified power supply cord set, cord is Type SPT-2 or heavier, minimum NO.18 AWG copper, one end with a molded-on male attachment plug cap (with a specified NEMA configuration), and the other is provided with a molded-on female connector body (with a specified IEC nonindustrial type configuration) or the equivalent.



Caution

- Do not place or drop heavy objects on or forcefully bend the AC plug cord. Doing so may damage the cord. Should the AC plug cord be damaged, consult a PENTAX Service Center.

- Do not touch or short-circuit the terminal area of the AC plug cord while the cord is plugged in.
- Do not handle the power plug with wet hands. This can cause an electric shock.
- Do not drop the product, or subject it to violent impact. This can cause the product to breakdown.
- Do not use the battery charger D-BC68P to charge batteries other than the rechargeable lithium-ion battery D-LI68. Attempting to charge other types of batteries may cause an explosion or heating, or may damage the battery charger.

About the Rechargeable Lithium-ion Battery

Warning

- If any leakage from the battery should come in contact with your eyes, do not rub them. Flush your eyes with clean water and get medical attention immediately.

Caution

- Only use the specified battery with this camera. Use of other batteries may cause an explosion or fire.
- Do not disassemble the battery. Disassembling the battery may cause an explosion or leakage.
- Remove the battery from the camera immediately if it becomes hot or begins to smoke. Be careful not to burn yourself during removal.
- Keep wires, hairpins, and other metal objects away from the + and - contacts of the battery.
- Do not short the battery or dispose of the battery in fire. This can cause an explosion or fire.
- If any leakage from the battery should come in contact with skin or clothing, it may cause irritation to the skin. Wash the affected areas thoroughly with water.
- Precautions for D-LI68 Battery Usage:
USE SPECIFIED CHARGER ONLY.
 - DO NOT INCINERATE.
 - DO NOT DISASSEMBLE.
 - DO NOT SHORT CIRCUIT.
 - DO NOT EXPOSE TO HIGH TEMP. (140°F / 60°C)

Keep the Camera and its Accessories out of the Reach of Small Children

Warning

- Do not place the camera and its accessories within the reach of small children.
 1. If the product falls or is operated accidentally, it may cause serious personal injuries.
 2. Wrapping the strap around a neck may cause suffocation.
 3. To avoid the risk of a small accessory such as the battery or SD Memory Cards from being swallowed by mistake, keep them out of the reach of small children. Seek medical attention immediately if an accessory is accidentally swallowed.

Care to be Taken During Handling

Before Using Your Camera

- When traveling, take the Worldwide Service Network listing that is included in the package. This will be useful if you experience problems abroad.
- When the camera has not been used for a long time, confirm that it is still working properly, particularly prior to taking important pictures (such as at a wedding or when traveling). Contents of the recording cannot be guaranteed if recording, playback or transferring your data to a computer, etc. is not possible due to a malfunction of your camera or recording media (SD Memory Card), etc.

About the Battery and Charger

- To keep the battery in optimum condition, avoid storing it in a fully charged state or in high temperatures.
- If the battery is left inserted and the camera is not used for a long time, the battery will over-discharge and shorten the battery's life.
- Charging the battery a day before use or on the day of use is recommended.
- The AC plug cord provided with this camera is developed exclusively for the battery charger D-BC68P. Do not use it with other devices.

Precautions on Carrying and Using Your Camera

- Do not subject the camera to high temperatures or high humidity. Do not leave the camera in a vehicle, as the temperature can get very high.
- Do not subject the camera to strong vibrations, shocks, or pressure. Use a cushion to protect the camera from vibrations of motorcycles, automobiles, or ships.
- The temperature range for camera use is 0°C to 40°C (32°F to 104°F).
- The monitor may appear black at high temperatures, but will return to normal at normal temperatures.
- The monitor may respond more slowly at low temperatures. This is due to liquid crystal properties, and is not a malfunction.
- Sudden temperature changes will cause condensation on the inside and outside of the camera. Place the camera in your bag or a plastic bag, and remove it after temperatures of the camera and surroundings are equalized.
- Avoid contact with garbage, mud, sand, dust, water, toxic gases, or salt. These could cause the camera to breakdown. Wipe the camera to dry off any rain or water drops.
- Do not press the monitor with excessive force. This could cause it to break or malfunction.
- Be careful not to overtighten the screw in the tripod socket when using a tripod.

Cleaning Your Camera

- Do not clean the camera with organic solvents such as thinner, alcohol, or benzene.
- Use a lens brush to remove dust accumulated on the lens. Never use a spray blower for cleaning as it may damage the lens.
- Please contact a PENTAX Service Center for professional cleaning of the CMOS sensor. (This will involve a fee.)
- Periodic inspections are recommended every one to two years to maintain high performance.

Storing Your Camera

- Do not store the camera with preservatives or chemicals. Storage in high temperatures and high humidity can cause mold to grow on the camera. Remove the camera from its case and store it in a dry and well-ventilated place.
- Avoid using or storing the camera where it may be exposed to static electricity or electrical interference.
- Avoid using or storing the camera in direct sunlight or in locations where it may be exposed to rapid changes in temperature or to condensation.

Other Precautions

- The SD Memory Card is equipped with a write-protect switch. Setting the switch to LOCK prevents new data from being recorded on the card, the stored data from being deleted, and the card from being formatted by the camera or computer.
- The SD Memory Card may be hot when removing the card immediately after using the camera.
- Do not remove the SD Memory Card or turn off the power while the card is being accessed. This may cause the data to be lost or the card to be damaged.
- Do not bend the SD Memory Card or subject it to violent impact. Keep it away from water and store away from high temperatures.
- Do not remove the SD Memory Card while formatting. The card may be damaged and become unusable.
- Data on the SD Memory Card may be deleted in the following circumstances. We do not accept any liability for data that is deleted if
 1. the SD Memory Card is mishandled by the user.
 2. the SD Memory Card is exposed to static electricity or electrical interference.
 3. the SD Memory Card has not been used for a long time.
 4. the SD Memory Card or the battery is removed while the card is being accessed.
- If the SD Memory Card is not used for a long time, the data on the card may become unreadable. Be sure to regularly make a backup of important data on a computer.
- Format new SD Memory Cards. Also format SD Memory Cards previously used with other cameras.

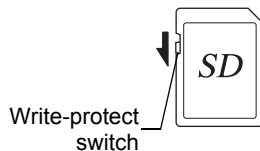

- Please note that deleting data stored on an SD Memory Card, or formatting an SD Memory Card does not completely erase the original data. Deleted files can sometimes be recovered using commercially available software. If you are going to discard, give away or sell your SD Memory Card, you should ensure that the data on the card is completely deleted or the card itself is destroyed if it contains any personal or sensitive information.
- The data on your SD Memory Card should be managed at your own risk.

Regarding Product Registration

In order to better serve you, we request that you complete the product registration, which can be found on the CD-ROM supplied with the camera or on the PENTAX website. Refer to p.205 for details. Thank you for your cooperation.



Contents

For Using Your Camera Safely	1
Care to be Taken During Handling	4
Contents	7
Composition of the Operating Manual	13
Before Using Your Camera	15
Checking the Contents of the Package	16
Names and Functions of the Working Parts	17
Capture Mode	18
Playback Mode	20
Monitor Display	22
How to Change Function Settings	30
Using the Direct Keys	30
Using the Control Panel	31
Using the Menus	32
Getting Started	35
Attaching the Strap	36
Inserting the Battery	37
Charging the Battery	37
Inserting/Removing the Battery	38
Battery Level Indicator	39
Using the AC Adapter (Optional)	40
Inserting/Removing an SD Memory Card	42
Attaching a Lens	44
Turning the Camera On and Off	46
Initial Settings	47
Setting the Display Language	47
Setting the Date and Time	49

Basic Operations 51

Basic Shooting Operation	52
Letting the Camera Choose the Optimal Settings	52
Using a Zoom Lens	54
Using the Built-in Flash	55
Setting the Flash Mode	55
Shooting with the Flash	57
Reviewing Images	59
Playing Back Images	59
Deleting a Single Image	60

Shooting Functions 61

How to Operate the Shooting Functions	62
Direct Keys Setting Items	62
Rec. Mode Menu Items	63
Movie Menu Items	65
Custom Setting Menu Items	65
Selecting the Appropriate Capture Mode	67
Auto Picture Modes	68
Scene Modes	69
Blur Control Mode	71
Exposure Modes	72
Setting the Exposure	73
Setting the Sensitivity	73
Changing the Exposure Mode	74
Adjusting the Exposure	77
Locking the Exposure Before Shooting (AE Lock)	80
Selecting the Metering Method	82
Reducing Image Noise (Noise Reduction)	83
Focusing	84
Setting the Focus Method	84
Setting the Autofocus Method	85
Focusing Using the  /  Button	88
Locking the Focus (Focus Lock)	89
Adjusting the Focus Manually (Manual Focus)	90
Checking the Depth of Field (Preview)	92
Using the Shake Reduction Function to Prevent Camera Shake	93
Taking Pictures Using the Shake Reduction Function	93
Shooting with Self-timer	95
Shooting with Remote Control (Optional)	96

Taking Pictures Continuously	99
Continuous Shooting	99
Interval Shooting	101
Multi-exposure	103
Recording Movies	105
Changing the Settings for Movie Recording	105
Recording Movies	107
Interval Movie	109
Playing Back Movies	111
Editing Movies	112

Shooting Settings **115**

Setting a File Format	116
Aspect Ratio	117
File Format	117
JPEG Recorded Pixels	118
JPEG Quality	119
Color Space	119
Setting the White Balance	120
Adjusting the White Balance Manually	122
Adjusting Brightness	123
Highlight Correction	123
Shadow Correction	124
HDR Capture	125
Setting the Image Finishing Tone	126
Setting Custom Image	126
Setting the Digital Filter	130
Saving Frequently Used Functions to the Quick Dial	132
Setting the Smart Effect	134
Saving the Camera Settings	136
Setting the Green Button and E-dial Functions	138
Setting the Green Button Operation	138
Setting the E-dial Operation in P Mode	140
Setting the Green Button Operation in M Mode	141
Setting the Lens Functions	142
Setting the ND Filter	142
Correcting Lens Distortion	143

Playback Functions

145

Playback Functions Operation	146
Playback Mode Palette Items	146
Playback Menu Items.....	147
Setting the Playback Display Method	148
Enlarging Images	149
Displaying Multiple Images	150
Multi-image Display Screen	150
Displaying Images by Folder.....	151
Displaying Images by Shooting Date (Calendar Display)	152
Joining Multiple Images (Index)	153
Playing Back Images Continuously.....	155
Displaying Rotated Images	157
Deleting Multiple Images	158
Deleting Selected Images	158
Deleting a Folder.....	159
Deleting All Images	160
Connecting the Camera to an AV Device	161
Connecting the Camera to a Video Input Terminal or HDMI Input Terminal	161
Setting the Video/HDMI Output Format	162

Editing Images

165

Changing the Image Size	166
Changing the Number of Recorded Pixels (Resize)	166
Cropping Out Part of the Image (Cropping)	167
Processing Images	168
Processing Images with Digital Filters	168
Editing Out the Unwanted Red-eye Effect	173
Developing RAW Images	174
Developing One RAW Image.....	174
Developing Multiple RAW Images	176

Changing Additional Settings 177

How to Operate the Set-up Menu	178
Set-up Menu Items	178
Camera Settings	180
Setting the Sound Effects, Date and Time, and Display Language	180
Setting the Monitor and the Menu Display	184
Selecting Settings to Save in the Camera (Memory)	189
Resetting the Menus	190
Checking the Camera Version Information	191
File Management Settings	193
Formatting an SD Memory Card	193
Protecting Images from Deletion (Protect)	194
Changing the Naming System for Folders	195
Creating New Folders	195
Setting the DPOF Settings	196

Connecting to a Computer 199

Manipulating Captured Images on a Computer	200
Saving Images on a Computer	201
Setting the USB Connection Mode	201
Connecting the Camera and a Computer	202
Using the Provided Software	203
Installing the Software	203

Using the Flash 207

Using the Built-in Flash	208
Flash Characteristics in Each Exposure Mode	208
Using the Slow-speed Sync	208
Using the Trailing Curtain Sync	209
Distance and Aperture when Using the Built-in Flash	209
Lens Compatibility with the Built-in Flash	210
Using an External Flash (Optional)	211
Using P-TTL Mode	212
Connecting an External Flash with an Extension Cord	213

Default Settings	216
Functions Available with Various Lens Combinations	222
Using a K-Mount Lens	223
Cleaning the CMOS Sensor	224
Removing Dust by Shaking the CMOS Sensor (Dust Removal)	224
Error Messages	225
Troubleshooting	227
Main Specifications.....	230
Index.....	236
WARRANTY POLICY.....	242

Composition of the Operating Manual

This Operating Manual contains the following chapters.

1 Before Using Your Camera

Explains the provided accessories and the names and functions of various parts.

2 Getting Started

Explains your first steps from purchasing the camera to taking pictures. Be sure to read this chapter and follow the instructions.

3 Basic Operations

Explains the procedures for taking and playing back pictures.

4 Shooting Functions

Explains the shooting-related functions.

5 Shooting Settings

Explains the procedures for changing the shooting settings, such as the file format.

6 Playback Functions

Explains the procedures for playing back and deleting images.

7 Editing Images

Explains the procedures for processing images and developing images taken in RAW format.

8 Changing Additional Settings

Explains the general camera settings and file management settings such as the monitor display settings and the image folder naming system.

9 Connecting to a Computer

Explains how to connect the camera to a computer, and includes installation instructions and a general overview of the provided software.

10 Using the Flash

Explains how to use the built-in flash and external flashes.

11 Appendix

Explains troubleshooting and provides various resources.

1

2

3

4

5

6

7



8

9

10

11

The symbols used in this Operating Manual are explained below.

	Indicates reference page number explaining a related operation.
	Indicates useful information.
	Indicates precautions to take when operating the camera.

In this Operating Manual, the buttons of the four-way controller are referred to in the following way.

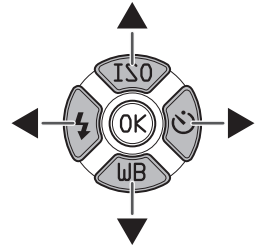

1 Before Using Your Camera

Check the package contents and the names and functions of working parts before use.

Checking the Contents of the Package	16
Names and Functions of the Working Parts	17
How to Change Function Settings	30

Checking the Contents of the Package

The following accessories are packaged with your camera.
Check that all accessories are included.

1

Before Using Your Camera



Hot shoe cover F κ
(Installed on camera)



Body mount cover
(Installed on camera)

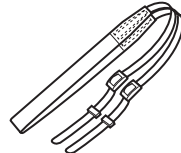

Strap
O-ST131

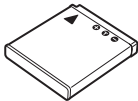

Rechargeable lithium-ion
battery D-LI68

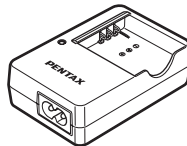

Battery charger
D-BC68P



AC plug cord

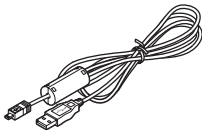

USB cable
I-USB7

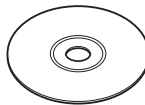

Software (CD-ROM)
S-SW131

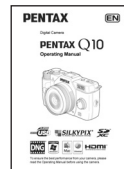

Operating Manual
(this manual)

Names and Functions of the Working Parts

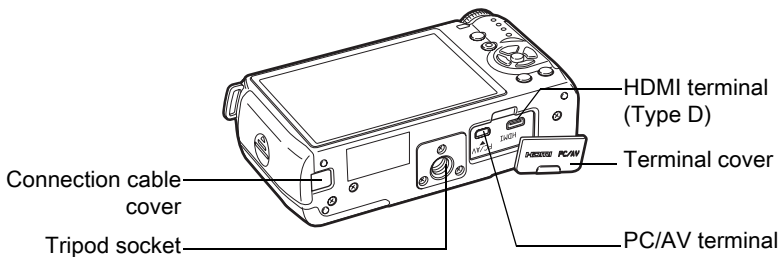
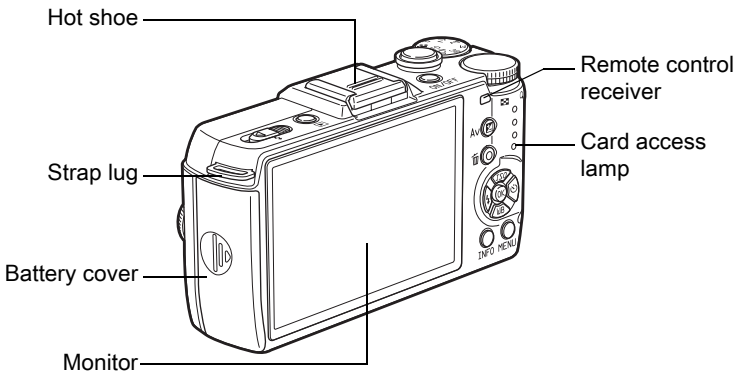
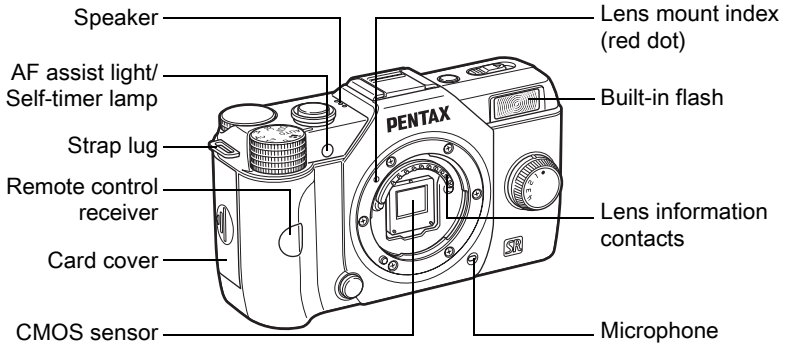

Capture Mode

Here, you can learn which parts are used and how they function when in capture mode.





1

Before Using Your Camera

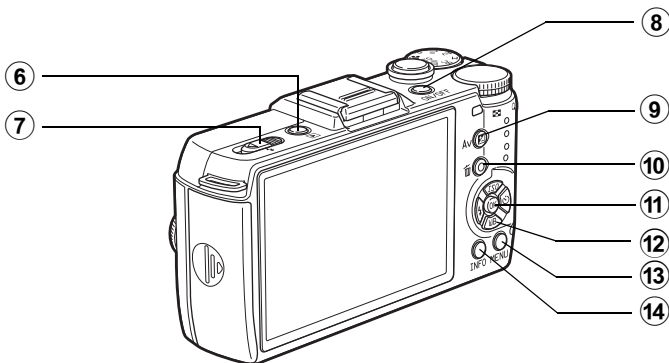
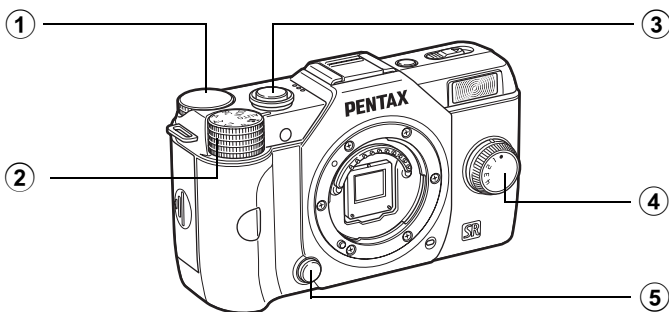

The factory default setting of each part is explained here, but some parts have multiple functions and work differently depending on the selected setting.





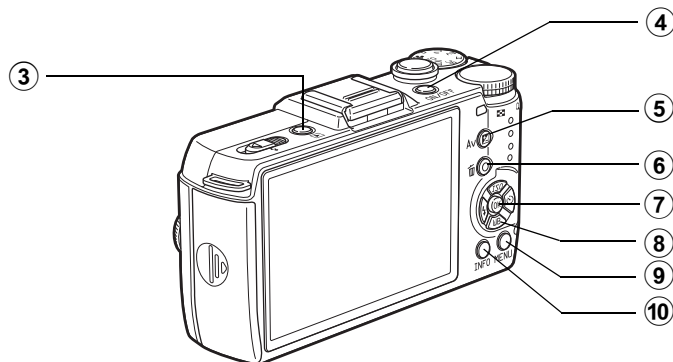
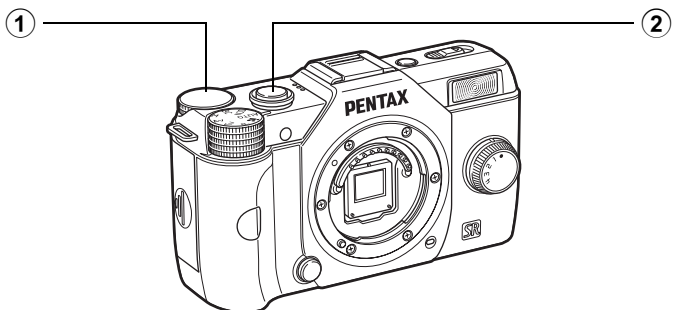

- ① E-dial**
Sets the shutter speed, aperture, and exposure compensation values. (p.74)
You can change the menu when a menu screen is displayed. (p.32)
You can change the settings when the control panel is displayed. (p.32)
- ② Mode dial**
Changes Capture mode. (p.67)
- ③ Shutter release button**
Press to capture images. (p.53)
- ④ Quick dial**
You can save your preferred shooting settings and then retrieve them easily later on. (p.132)
- ⑤ Lens unlock button**
Press to detach a lens. (p.45)
- ⑥  (Playback) button**
Switches to Playback mode. (p.59)
- ⑦ Flash pop-up switch**
Slide to pop up the built-in flash. (p.57)
- ⑧ Power switch**
Press to turn the camera on and off. (p.46)
- ⑨  Av (EV Compensation) button**
Press to set the exposure compensation and aperture values. (p.75, p.77)
- ⑩  (Green/Delete) button**
Press to reset the values being adjusted, or you can assign a function to this button. (p.138)
- ⑪ OK button**
When the control panel or a menu screen is displayed, press this button to confirm the selected item.
- ⑫ Four-way controller (▲▼◀▶)**
Displays the Sensitivity/White Balance/Flash Mode/Drive Mode setup menu. (p.62)
When the control panel or a menu screen is displayed, use this to move the cursor or change items.
- ⑬ MENU button**
Displays the [ Rec. Mode 1] menu (p.63). Press this button while the menu is displayed to return to the previous screen. (p.32)
- ⑭ INFO button**
Changes the style of the display on the monitor. (p.22)

Playback Mode

Here, you can learn which parts are used and how they function when in playback mode.



- ① **E-dial**
Use this to enlarge an image (p.149) or display multiple images at the same time (p.150).
- ② **Shutter release button**
Press halfway to switch to Capture mode.
- ③ ** (Playback) button**
Switches to Capture mode.
- ④ **Power switch**
Press to turn the camera on and off. (p.46)
- ⑤ ** Av (EV Compensation) button**
When the file format of the last captured image is JPEG, and its data still remains in the buffer memory, press this button to save the image in RAW format. (p.59)
- ⑥ ** (Green/Delete) button**
Press to delete images, or resets the values being adjusted. (p.60, p.138)
- ⑦ **OK button**
Confirms the setting you selected in the menu or playback screen.
- ⑧ **Four-way controller (▲▼◀▶)**
Use this to move the cursor or change items in the menu or playback screen. Press the four-way controller (▼) to display the playback mode palette. (p.146)
- ⑨ **MENU button**
Displays the [ Playback 1] menu (p.147).
- ⑩ **INFO button**
Changes the style of the display on the monitor. (p.25)

Monitor Display

Various information appears on the monitor depending on the status of the camera.



The brightness level and the color of the monitor can be adjusted. (p.187)

Capture Mode

While shooting, the current shooting function settings are displayed on the monitor. You can change the style of the display by pressing the **INFO** button.

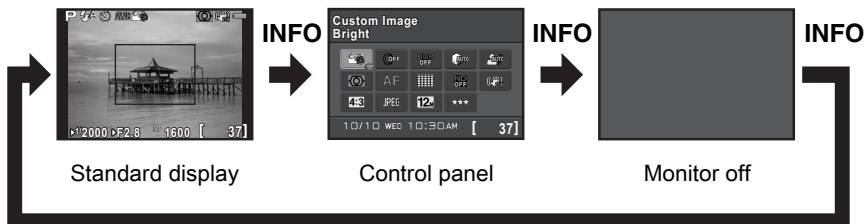

● Standard display

(All items are displayed here for explanatory purposes. The actual display may differ.)

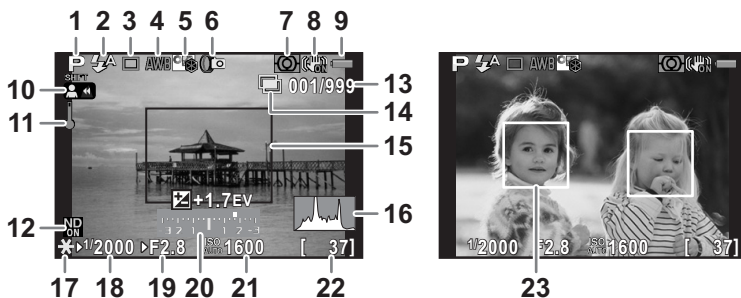

- | | | | |
|---|-----------------------|---|----------------------------|
| 1 | Capture Mode (p.67) | 5 | Custom Image (p.126) |
| 2 | Flash Mode (p.55) | 6 | Interval Shooting (p.101)/ |
| 3 | Drive Mode (p.62) | | HDR Capture (p.125)/ |
| 4 | White Balance (p.120) | | Digital Filter (p.130) |

- | | | | |
|----|---|----|--|
| 7 | AE Metering (p.82) | 15 | AF frame (p.53) |
| 8 | Shake Reduction (p.93)/
Movie SR (p.106) | 16 | Histogram (p.28) |
| 9 | Battery level (p.39) | 17 | AE Lock (p.80) |
| 10 | Turning the focusing ring
in MF mode (p.90) | 18 | Shutter speed (p.75) |
| 11 | Temperature warning | 19 | Aperture value (p.75) |
| 12 | ND Filter (p.142) | 20 | EV bar (p.77) |
| 13 | Number of shots during
Interval Shooting or Multi-
exposure | 21 | Sensitivity (p.73) |
| 14 | Interval Shooting (p.101)/
Multi-exposure (p.103)/
Smart Effect (p.134) | 22 | Image storage capacity |
| | | 23 | Face detection frame (when
[Autofocus Method] is set
to [Face Detection]) (p.85) |
- * Indicator 15 is displayed in white. When the subject is in focus, a green square frame is displayed instead. It turns red when the subject is not in focus. It is not displayed when [Focus Method] is set to **MF**.
- * For indicator 23, a main face detection frame is displayed in yellow and other frames are displayed in white when [Autofocus Method] is set to [Face Detection].

● Control panel

Press the **INFO** button in Capture mode to display the control panel and change settings. (p.31)

📷 mode

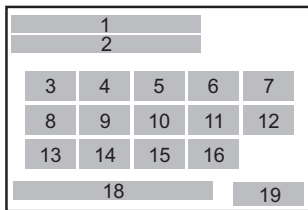

📷 mode

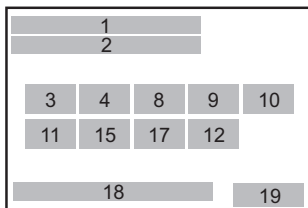

- | | | | |
|----|---|----|--|
| 1 | Function name | 11 | ND Filter (p.142) |
| 2 | Setting | 12 | Shake Reduction (p.93)/
Movie SR (p.106) |
| 3 | Custom Image (p.126)/
SCN mode (p.69) | 13 | Aspect Ratio (p.117) |
| 4 | Digital Filter (p.130) | 14 | File Format (p.117) |
| 5 | HDR Capture (p.125) | 15 | JPEG Recorded Pixels (p.118)/
Movie Recorded Pixels (p.105) |
| 6 | Highlight Correction (p.123) | 16 | JPEG Quality (p.119) |
| 7 | Shadow Correction (p.124) | 17 | Sound (p.105) |
| 8 | AE Metering (p.82) | 18 | Current date and time (p.48) |
| 9 | Focus Method (p.84) | 19 | Image storage capacity |
| 10 | Autofocus Method (p.85) | | |



- Settings that cannot be changed due to the current camera setup cannot be selected.
- If no operations are made within 30 seconds while the control panel is displayed, the standard display will reappear.
- The control panel for the **SCN** (Scene) mode is displayed when the mode dial is set to **SCN**. (p.70)
- For more information about the Capture mode display, refer to “Setting the Capture Mode Display Method” (p.185).

Playback Mode

The camera switches the type of information displayed when you press the **INFO** button during playback.

Standard display	Captured image, file format and operation guide indicators are displayed.
Histogram display	Captured image and histogram (Brightness/RGB) are displayed. Not available during movie playback. (p.26)
Detailed information display	Detailed information on how and when the image was taken is displayed. (p.27)
No info. display	Only the captured image is displayed.

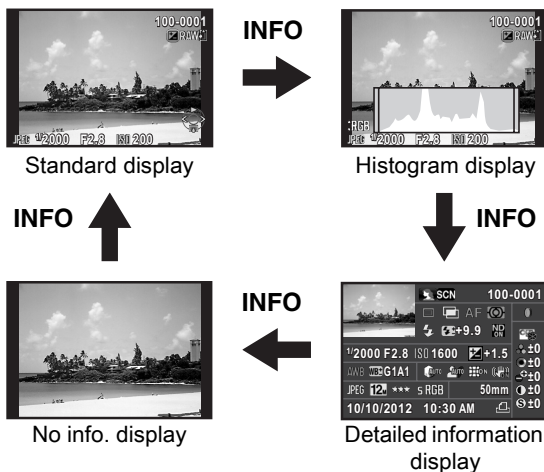

The type of information display that is shown first during playback is the same as that of the last playback in the previous session. If [Playback Info Display] is set to (Off) in [Memory] of the [Rec. Mode 3] menu, the [Standard display] always appears first when the camera is turned on. (p.189)

● Histogram display

The following histograms can be displayed when playing back still pictures. The “Brightness histogram” shows the distribution of brightness and the “RGB histogram” shows the distribution of color intensity. Press the four-way controller (▲▼) to switch between “Brightness histogram” and “RGB histogram”.

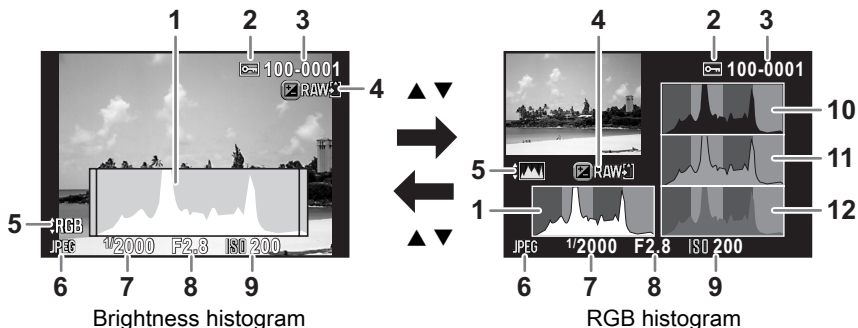

- | | | | |
|---|---|----|----------------|
| 1 | Histogram (Brightness) | 7 | Shutter speed |
| 2 | Protect setting | 8 | Aperture value |
| 3 | Folder number-File number | 9 | Sensitivity |
| 4 | Save RAW data | 10 | Histogram (R) |
| 5 | Switch RGB histogram/
Brightness histogram | 11 | Histogram (G) |
| 6 | File Format | 12 | Histogram (B) |

* Indicator 2 appears only for protected images.

* Indicator 4 appears only when the file format of the last captured image is JPEG, and the image can also be saved in RAW format. (p.59)



If [Bright/Dark Area] of the [▶ Playback 1] menu is set to (On), bright (overexposed) portions blink red and dark (underexposed) portions blink yellow (except when in RGB histogram display or Detailed information display). (p.148)

● Detailed information display

(All items are displayed here for explanatory purposes. The actual display may differ.)

Still picture

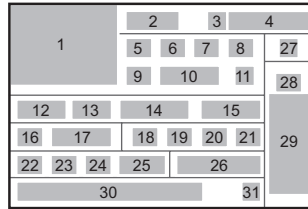

Movie

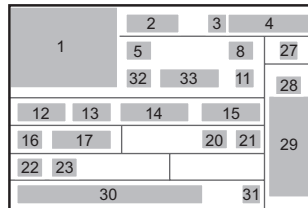

- | | | | |
|----|--|----|--|
| 1 | Captured image | 17 | White Balance fine-tuning (p.122) |
| 2 | Capture Mode (p.67) | 18 | Highlight Correction (p.123) |
| 3 | Protect setting (p.194) | 19 | Shadow Correction (p.124) |
| 4 | Folder number-File number (p.195) | 20 | Distortion Correction (p.143) |
| 5 | Drive Mode (p.62) | 21 | Shake Reduction (p.93)/
Movie SR (p.106) |
| 6 | HDR Capture (p.125)/
Multi-exposure (p.103) | 22 | File Format (p.117) |
| 7 | Focus Method (p.84) | 23 | JPEG Recorded Pixels (p.118)/
Movie Recorded Pixels (p.105) |
| 8 | AE Metering (p.82) | 24 | JPEG Quality (p.119) |
| 9 | Flash Mode (p.55) | 25 | Color Space (p.119) |
| 10 | Flash Exposure Compensation (p.56) | 26 | Lens focal length |
| 11 | ND Filter (p.142) | 27 | Digital Filter (p.130) |
| 12 | Shutter speed (p.75) | 28 | Custom Image setting (p.126) |
| 13 | Aperture value (p.75) | 29 | Custom Image parameters (p.127) |
| 14 | Sensitivity (p.73) | 30 | Shooting date and time |
| 15 | EV Compensation (p.77) | 31 | DPOF setting (p.196) |
| 16 | White Balance (p.120) | 32 | Sound (p.105) |
| | | 33 | Recording time |

Using the Histogram

A histogram shows the brightness distribution of an image.

The horizontal axis represents brightness (dark at the left and bright at the right) and the vertical axis represents the number of pixels.

The shape and the distribution of the histogram before and after shooting tell you whether the exposure level

and contrast are correct or not, and lets you decide if you need to adjust the exposure and take a picture again.

- ☞ Adjusting the Exposure (p.77)
- ☞ Adjusting Brightness (p.123)

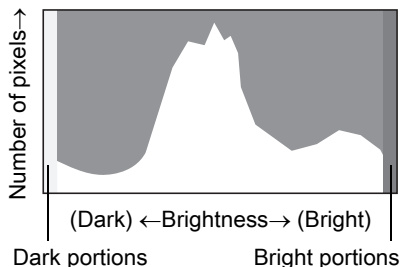

When the image is underexposed, the part to the left is cut off (underexposed portions with no detail) and when the image is overexposed, the part to the right is cut off (overexposed portions with no detail).

This camera can be set so that it displays the Bright/Dark Area warning during Capture or Playback mode.

- ☞ Setting the Playback Display Method (p.148)
- ☞ Setting the Capture Mode Display Method (p.185)
- ☞ Setting the Display for Instant Review (p.186)











Distribution of color intensity is displayed for each color in the RGB histogram. The right side of the graphs look similar for images that have the white balance adjusted well. If only one color is lopsided to the left, that color is too intense.

- ☞ Setting the White Balance (p.120)

Guide Indicators

The following indicators appear on the monitor to indicate the keys, buttons and e-dial that can be operated at that time.

Example)

	Four-way controller (▲)		Shutter release button
	Four-way controller (▼)		MENU button
	Four-way controller (◀)		INFO button
	Four-way controller (▶)		Green/Delete button
	OK button		Av button
	E-dial		



- The image on the monitor may differ from the captured image if the brightness of the subject is low or high.
- If any changes occur in the light source during shooting, the image may flicker. You can cut down on flicker by setting the power frequency in [Flicker Reduction] of the [👉 Set-up 1] menu to that used in your region.
- If the camera position is changed rapidly during shooting, the image may not be displayed with the appropriate brightness. Wait for the display to become stable before shooting.
- Noise may appear on the monitor image when used in dark locations.
- The higher the sensitivity, the more noise and color unevenness may occur in the monitor image and/or captured image.
- Images cannot be displayed on the monitor while data is being saved to an SD Memory Card.
- If you continue shooting for a prolonged period, the internal temperature of the camera may increase, resulting in lower quality images. It is recommended that you turn off the camera when not shooting. To prevent the image quality from degrading, allow enough time for the camera to cool down while shooting with long exposures or recording movies.

Function settings can be changed using the direct keys, control panel or menus.

This section explains the basic ways to change function settings.

1

Before Using Your Camera

Using the Direct Keys

In Capture mode, you can set Sensitivity, White Balance, Flash Mode and Drive Mode by pressing the four-way controller (▲▼◀▶). (p.62) Below, how to set [Flash Mode] is explained as an example.

- 1 Press the four-way controller (◀) in Capture mode.

The Flash Mode setting screen appears.

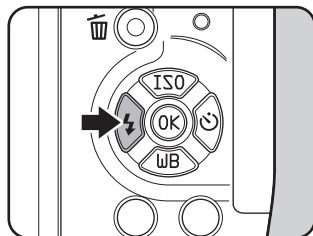

- 2 Use the four-way controller (◀▶) to select a flash mode.



- 3 Press the OK button.

The camera is ready to take a picture.

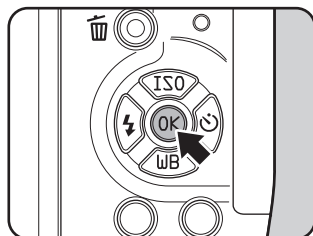

Using the Control Panel

While shooting, the current settings can be checked on the monitor, and you can switch to the control panel and change settings. Below, how to set [JPEG Quality] is explained as an example.

- 1 Press the **INFO** button in Capture mode.

The control panel appears.

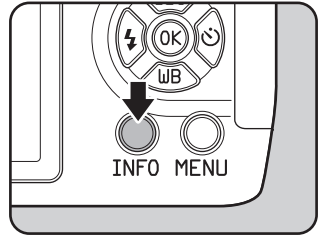

- 2 Use the four-way controller (▲▼◀▶) to select an item you want to change the setting for.

You cannot select items that cannot be changed as a result of current camera settings.



- 3 Press the **OK** button.

The setup screen of the selected item appears.



- 4 Use the four-way controller (◀▶) or e-dial to select a setting value.

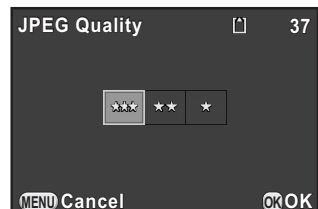

5 Press the **OK** button.

The camera returns to the control panel.
Next, set other items.

6 Press the **MENU** button or the shutter release button halfway.

The camera is ready to take a picture.



You can also change the setting by turning the e-dial after selecting the item you want to change in Step 2. Detailed settings such as parameters can be changed after pressing the **OK** button.

Using the Menus

This section explains how to use the following menus: [📷 Rec. Mode], [🎥 Movie], [▶ Playback], [⚙ Set-up] and [Ⓢ Custom Setting]. Below, how to set [High-ISO NR] in the [📷 Rec. Mode 2] menu is explained as an example.

1 Press the **MENU** button in Capture mode.

The [📷 Rec. Mode 1] menu appears on the monitor.

The menus listed below are displayed in the following situations.

When the mode dial is set to 📷	[🎥 Movie 1] menu
In Playback mode	[▶ Playback 1] menu

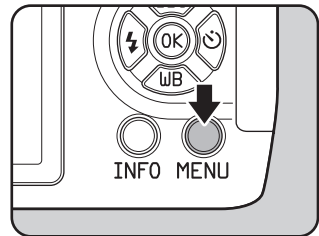

2 Press the four-way controller (▶).

Each time the four-way controller (▶) is pressed, the menu will change in the following sequence: [📷 Rec. Mode 2], [📷 Rec. Mode 3], [🎥 Movie 1], [▶ Playback 1] ... [📷 Rec. Mode 1].

You can also change the menu by turning the e-dial.

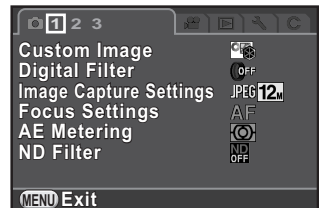

- 3** Use the four-way controller (▲▼) to select an item.

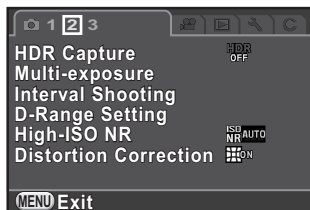

- 4** Press the four-way controller (▶). Available settings are displayed in the pop-up menu or submenu.

Available settings are displayed in the pop-up menu or submenu.

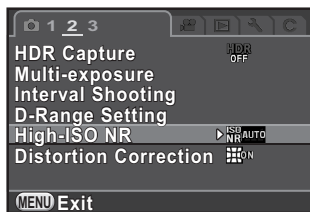

- 5** Use the four-way controller (▲▼) to select a setting.

Press the **MENU** button to cancel the pop-up menu, or return to the previous screen.

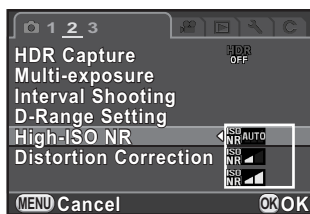

- 6** Press the **OK** button.

The setting is saved.
Press the **MENU** button if a submenu is displayed.
Next, set other items.

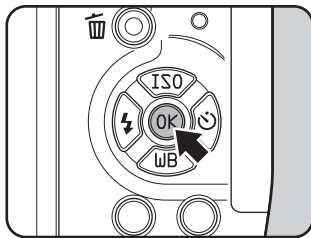

- 7** Press the **MENU** button.

The screen that was displayed before selecting the menu appears again.

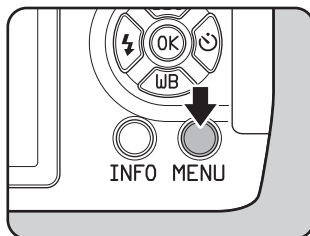



Even after you press the **MENU** button and close the menu screen, your settings will not be saved if the camera is turned off improperly (such as by removing the battery while the camera is on).



1

- You can select whether to display the menu tab selected the last time first, or to always display the [📷 Rec. Mode 1] menu first. (p.186)
- Refer to the following pages for details on each menu.
 - [📷 Rec. Mode] menu 📖 p.63
 - [🎬 Movie] Menu 📖 p.65
 - [▶ Playback] menu 📖 p.147
 - [🔧 Set-up] menu 📖 p.178
 - [C Custom Setting] menu 📖 p.65
- Some shooting functions can be saved to the quick dial and loaded with the dial operation. (p.132)

2 Getting Started

This chapter explains your first steps from purchasing the camera to taking pictures. Be sure to read this and follow the instructions.

Attaching the Strap	36
Inserting the Battery	37
Inserting/Removing an SD Memory Card	42
Attaching a Lens	44
Turning the Camera On and Off	46
Initial Settings	47

Attaching the Strap

- 1** Pass the end of the strap through the strap lug, then secure it on the inside of the clasp.

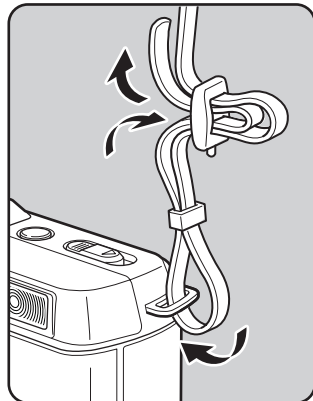

- 2** Attach the other end of the strap in the same manner as described above.

Insert the battery into the camera. Use the rechargeable lithium-ion battery D-LI68 exclusively developed for this camera.

Charging the Battery

When using the battery for the first time, or when the battery has not been used in a long time, or when [Battery depleted] appears, recharge the battery.

Note: AC plug cord “Listed, Type SPT-2 or NISPT-2, 18/2 flexible cord, rated 125 V, 7A, minimum 6ft (1.8m)”

1 Connect the AC plug cord to the battery charger.

2 Plug the AC plug cord into the power outlet.

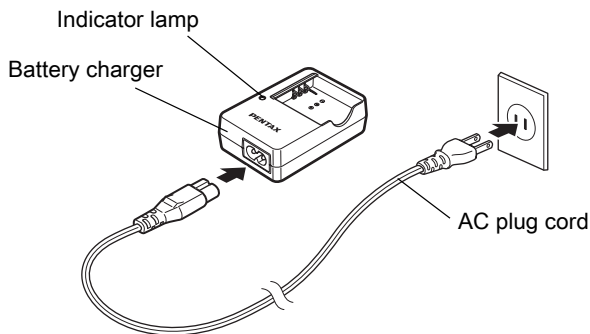

3 Face the ▲ mark on the battery up, and insert it into the battery charger.

The indicator lamp is lit while charging and turns off when the battery is fully charged.

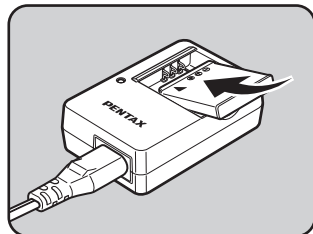

4 When the battery is fully charged, remove the battery from the battery charger.



- Do not use the provided Battery Charger D-BC68P to charge batteries other than D-LI68. Charging other batteries may cause damage or heating.
- Replace the battery with a new one in the following cases:
 - If the indicator lamp blinks or does not light after the battery is inserted correctly
 - If the battery starts to run down more quickly even after being charged (the battery may have reached the end of its service life)



The maximum charging time is approximately 115 minutes (it depends on temperature and remaining battery power). Charge in a location where the temperature is between 0°C and 40°C.

Inserting/Removing the Battery



- Insert the battery correctly. If the battery is inserted incorrectly, it may not be removed. Wipe the electrodes of the battery with a soft dry cloth before inserting.
- Do not open the battery cover or remove the battery while the power is on.
- Be careful as the camera or battery may become hot when the camera is used continuously for a long period of time.
- Remove the battery when you will not use the camera for a long while. The battery may leak and damage the camera if left installed during prolonged periods of non-use. If the removed battery will not be used for six months or longer, charge the battery for about 30 minutes before storing it. Be sure to recharge the battery every six to twelve months.
- Store the battery in a location where the temperature will remain below room temperature. Avoid locations with high temperatures.
- The date and time may be reset if you leave the battery out of the camera for long periods of time. If this occurs, follow the procedure described in “Setting the Date and Time” (p.48) to set the current date and time.

- 1** Slide the battery cover in the direction of the arrow, and then lift it to open (①→②).

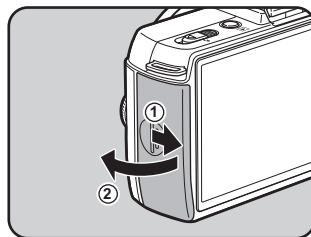

- 2** Insert the battery until it locks into place with the ▲ mark facing toward the lens.

To remove the battery, push the battery lock lever in the direction of the arrow (③) with your finger.

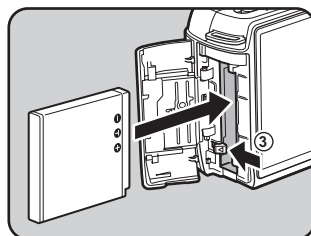



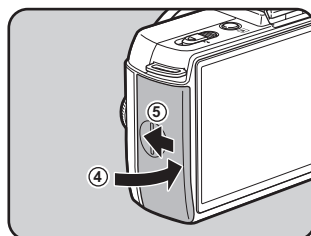

- 3** Close the battery cover, and then slide it in the direction of the arrow (④→⑤).





Battery Level Indicator

You can confirm remaining battery level by checking the display on the monitor.

Monitor Display	Battery Level
 (Green)	Battery is full.
 (Green)	Battery is close to full.
 (Yellow)	Battery is running low.
 (Red)	Battery is almost empty.
[Battery depleted]	The camera turns off after displaying the message.



-  or  may appear even when the battery level is sufficient if the camera is used at low temperatures or when performing continuous shooting for a long period of time.
- Battery performance temporarily decreases as the temperature decreases. When using the camera in cold climates, have extra batteries at hand and keep them warm in your pocket. Battery performance will return to normal when returned to room temperature.
- Have extra batteries ready when traveling overseas, taking pictures in cold climates, or taking a lot of pictures.

Using the AC Adapter (Optional)

We recommend the use of the AC adapter kit K-AC115 (optional) when using the monitor for a long time or when connecting the camera to a computer or AV device.



The AC Adapter Kit K-AC115 includes AC Adapter D-AC115, DC Coupler D-DC115, and AC plug cord.

1 Make sure that the camera is turned off.

2 Open the battery cover.

Refer to Step 1 on p.39.

Remove the battery if it is inserted in the camera.

3 Pull down the connection cable cover (①) on the bottom side of the battery chamber, and insert the DC coupler into the battery chamber.

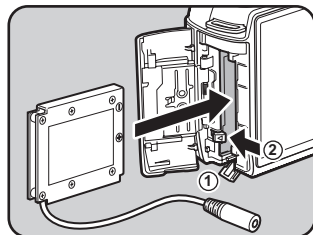

4 Close the battery cover.

Pull out the connection cable from the connection cable cover section.

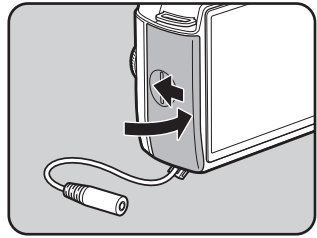

5 Connect the DC coupler and the AC adapter.

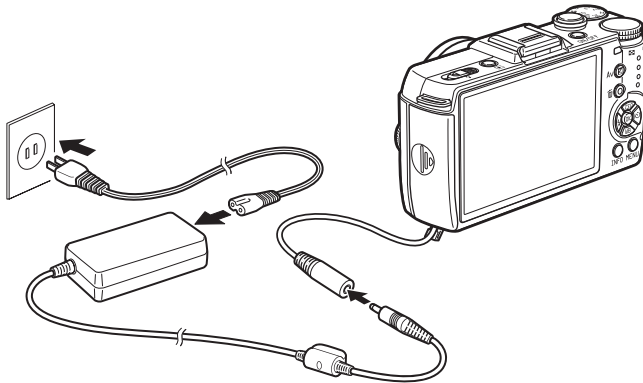

6 Connect the AC adapter to the AC plug cord.

7 Plug the AC plug cord into the power outlet.



- Make sure the camera is turned off before connecting or disconnecting the AC adapter.
- Make sure connections are secure between the terminals. The SD Memory Card or data may be corrupted if disconnected while the card is being accessed.
- The connection cable will protrude from the connection cable cover on the camera while the AC adapter is in use.
- After removing the DC coupler, return the connection cable cover to its original position.



Be sure to read the manual of the AC adapter kit before using the AC adapter.

Inserting/Removing an SD Memory Card

This camera uses a commercially available SD Memory Card, SDHC Memory Card, or SDXC Memory Card.

Make sure the camera is turned off before inserting or removing the SD Memory Card.

Caution

- Do not remove the SD Memory Card while the card access lamp is lit.
- If the card cover is opened while the power is on, the camera will turn off. Do not open the cover while the camera is in use.
- Use this camera to format (initialize) an SD Memory Card that is unused or has been used on other devices. Refer to "Formatting an SD Memory Card" (p.193) for details on formatting.
- Use a high-speed memory card when recording movies. If a write speed cannot keep up with a recording speed, the writing may stop during recording.

1 Make sure that the camera is turned off.

2 Slide the card cover in the direction of the arrow, and then lift it to open (①→②).

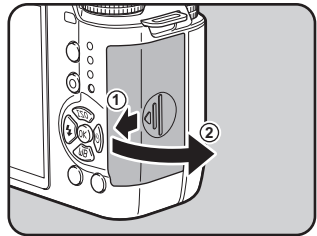

3 Insert the card all the way with the SD Memory Card label facing toward the monitor.

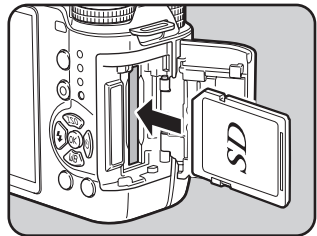

Push the SD Memory Card in once to remove.

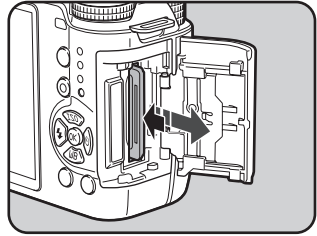

- 4** Close the card cover, and then slide it in the direction of the arrow (③ → ④).

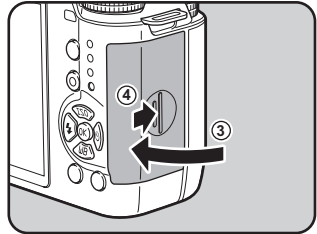

For details on the approximate number of images that can be recorded on an SD Memory Card, refer to “Approximate Image Storage Capacity by Size” (p.235).

Attach a Q-mount lens to the camera's body. The steps will be described here using a 01 STANDARD PRIME lens.



- When attaching/removing the lens, choose an environment that is relatively free of dirt and dust.
- Keep the body mount cover on the camera when a lens is not attached.
- Be sure to attach the lens mount cover and lens cap to the lens after removing it.
- Do not insert any fingers into the camera mount or touch the CMOS sensor.
- The camera body and lens mount incorporate lens information contacts. Dirt, dust, or corrosion may damage the electrical system. Please contact a PENTAX Service Center for professional cleaning.
- We assume no responsibility nor liability for accidents, damages and malfunctions resulting from the use of lenses made by other manufacturers.

1 Make sure that the camera is turned off.

2 Remove the body mount cover (①) and lens mount cover (②).

Be sure to put the lens down with the lens mount side facing upward to protect the lens mount from damage.

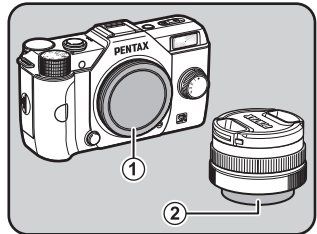

3 Align the lens mount index (red dots: ③) on the camera and the lens, and secure by turning the lens clockwise until it clicks.

After attaching, turn the lens counterclockwise to check that the lens is locked in place.

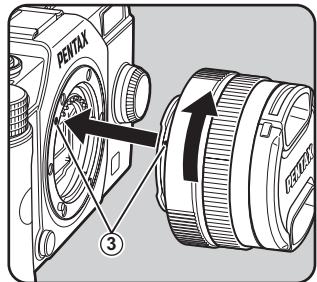

- 4** Remove the front lens cap by pushing the indicated portions inward.

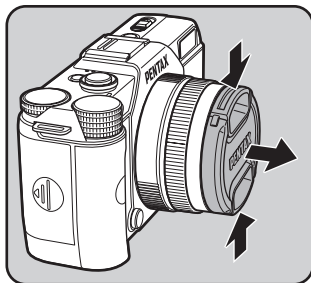

To remove the lens

Attach the lens cap first, and then turn the lens counterclockwise while pushing the lens unlock button (4).

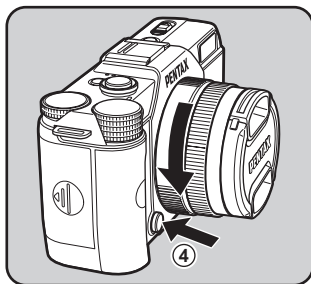



If the lens is removed while the power is on, the monitor will turn off, and the shutter release button will be locked. Do not remove the lens while the power is on.

1 Press the power switch.

The camera will turn on.

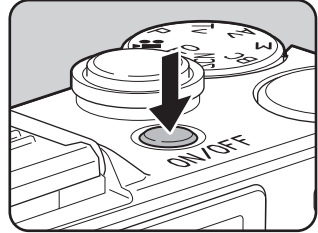
Press the power switch again to turn off the camera.



- Always turn the camera off when not in use.
- The power will automatically turn off when you do not perform any operations within a set period of time (Auto Power Off). By default, the camera is set to turn off automatically after 1 minute of inactivity. You can change the setting in [Auto Power Off] of the [Set-up 2] menu. (p.184)
- To turn the camera on in playback mode, press the power switch while pushing the  button.

The first time the camera is turned on after purchasing, the [Language/言語] screen appears on the monitor. Follow the procedure below to set the language displayed on the monitor and the current date and time.

If the [Date Adjustment] screen appears, set the date and time by following the procedure in “Setting the Date and Time” (p.48).

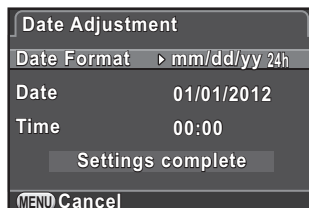

Setting the Display Language

You can choose the language in which the menus, error messages, etc. are displayed from the following: English, French, German, Spanish, Portuguese, Italian, Dutch, Danish, Swedish, Finnish, Polish, Czech, Hungarian, Turkish, Greek, Russian, Korean, Traditional Chinese, Simplified Chinese and Japanese.

- 1 Use the four-way controller (▲▼◀▶) to select the desired language, and press the OK button.**

The [Initial Setting] screen appears in the selected language.

Proceed to Step 6 if 🏠 (Hometown) does not have to be changed.



- 2 Press the four-way controller (▼) to move the frame to 🏠, and press the four-way controller (▶).**

The [🏠 Hometown] screen appears.

3 Use the four-way controller (◀▶) to select a city.

Turn the e-dial to change the region. Refer to “List of World Time Cities” (p.183) for cities that can be selected as a hometown.

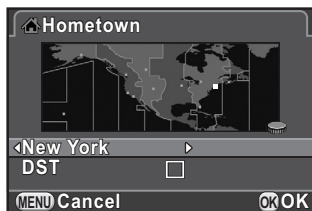

4 Press the four-way controller (▼) to select [DST] (daylight saving time), and use the four-way controller (◀▶) to select or .

5 Press the OK button.

The camera returns to the [Initial Setting] screen.

6 Press the four-way controller (▼) to select [Settings complete], and press the OK button.

The [Date Adjustment] screen appears.



When the hometown and the date and time are not set, the [Initial Setting] screen or [Date Adjustment] screen will be displayed again the next time the camera is turned on.

Setting the Date and Time

Set the current date and time and the display style.

1 Press the four-way controller (▶), and use the four-way controller (▲▼) to select the date format.

Choose [mm/dd/yy], [dd/mm/yy] or [yy/mm/dd].

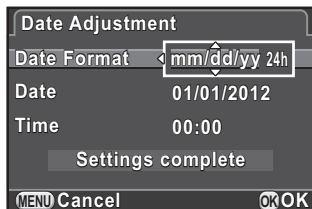

2 Press the four-way controller (▶), and use the four-way controller (▲▼) to select 24h (24-hour display) or 12h (12-hour display).

3 Press the **OK** button.
The frame returns to [Date Format].

4 Press the four-way controller (▼), and press the four-way controller (▶).
The frame moves to the month if the date format is set to [mm/dd/yy].

5 Use the four-way controller (▲▼) to set the month.
Set the day and year in the same manner.
Next, set the time.
If you select [12h] in Step 2, the camera switches between am and pm depending on the time.

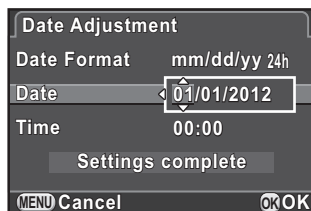

6 Press the four-way controller (▼) to select [Settings complete], and press the **OK** button.

The camera switches to Capture mode and is ready to take a picture.
If you set the date and time from the menu, the screen will return to the [🔍 Set-up 1] menu. In this case, press the **MENU** button.

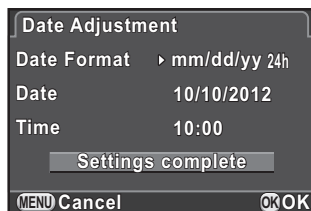

- When you press the **OK** button in Step 6, the seconds value is set to 0. To set the exact time, press the **OK** button when the time signal (on the TV, radio, etc.) reaches 0 seconds.
- Pressing the **MENU** button while setting the date and time cancels the settings made up to that point and switches the camera to Capture mode.
- You can change the language and date and time settings from the menu. (p.181, p.184)

3 Basic Operations

This chapter explains basic operations for shooting by setting mode dial to **AUTO** (Auto Picture) to have the camera select the optimum settings based on the subject. For information about advanced functions and settings for taking pictures, refer to chapter 4 and onward.

Basic Shooting Operation	52
Using the Built-in Flash	55
Reviewing Images	59

Letting the Camera Choose the Optimal Settings

This camera features various capture modes, focus modes, and drive modes. This section explains how to take pictures by simply pressing the shutter release button.

1 Set the mode dial to **AUTO**.

The camera will select the optimal capture mode for the subject.

- ☞ Selecting the Appropriate Capture Mode (p.67)

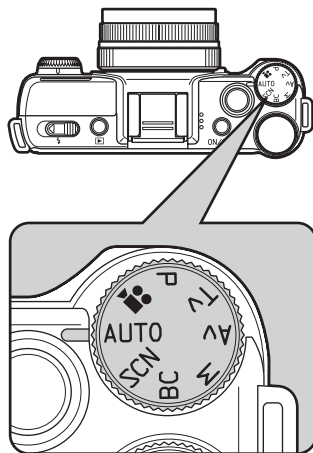









2 View the subject on the monitor.

A zoom lens can be used to change the size of the subject on the monitor. (p.54)

3 Position the subject inside the AF frame, and press the shutter release button halfway.

The autofocus system operates.

The AF frame turns green and you will hear a beep when the subject comes into focus.

When set to **AUTO** (Auto Picture) mode, the optimal capture mode is automatically selected from  (Standard),  (Portrait),  (Landscape),  (Macro),  (Night Scene Portrait),  (Sunset),  (Blue Sky) or  (Forest). (p.68)



AF frame

4 Press the shutter release button fully.

The picture is taken.



This action is referred to as “releasing the shutter” or “release”.

5 Review the captured image on the monitor.

The image appears for 1 second on the monitor shortly after capturing (Instant Review).



The following operations can be performed during Instant Review.

Available operations

 /  button	Deletes the image. (p.60)
E-dial	Magnifies the image. (p.149)
 Av button	Saves the RAW image. (p.59)

 Setting the Display for Instant Review (p.186)



- The shutter sound and the beep that sounds when the image is focused can be turned off. (p.180)
- You can set the camera so that pressing the  /  button will focus automatically, in the same way as pressing the shutter release button halfway. (p.88)
- You can preview the image on the monitor and check the depth of field before taking pictures. (p.92)

Using a Zoom Lens

Enlarge the subject (telephoto) or capture a wider area (wide angle) with a zoom lens. Adjust the subject to the desired size and take pictures.

1 Turn the zoom ring to the right or left.

The angle of view changes.

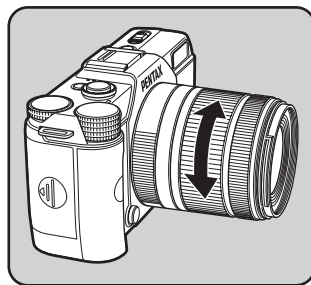

The following functions can be set on the camera depending on the lens being used.

- Setting whether to use the ND filter built-in to the lens (p.142).
- Correcting distortion (p.143)









Use a flash to take pictures in low light or backlit conditions.

The built-in flash is optimum for a subject at a distance from approx. 0.7 m to 5 m. Vignetting (darkening of the corners of the image due to a lack of light) may occur when used at a distance closer than 0.7 m (this distance varies slightly depending on the lens being used and the sensitivity setting. (p.209))





For details on the built-in flash and instructions on how to take pictures with an external flash, refer to “Using the Flash” (p.207).

Setting the Flash Mode

Flash Mode	Function
 Auto Flash Discharge	Automatically measures the ambient light and determines whether to use the flash.
 Auto Flash+Red-eye Reduction	Discharges a pre-flash for red-eye reduction before the automatic flash.
 Flash On	Discharges the flash for each picture.
 Flash On+Red-eye Reduction	Discharges a pre-flash for red-eye reduction before the main flash.
 Slow-speed Sync	Sets to a slow shutter speed depending on the brightness. When using this to shoot a portrait with the sunset in the background, both the person and the background are captured beautifully.
 Slow-speed Sync +Red-eye	Discharges a pre-flash for red-eye reduction before the main flash is discharged with Slow-speed Sync.
 Trailing Curtain Sync	Discharges the flash immediately before closing the shutter. Captures moving objects as if they are leaving a light trail behind them. (p.209)
 Flash Off	The flash is deactivated.

2 Turn the e-dial.

The flash compensation value is displayed.

Press the /  button to reset the value to 0.0.



- When the flash output exceeds its maximum amount, the compensation will not be effective even if the compensation value is set to the plus (+) side.
- Compensating to the minus (-) side may have no effect if the subject is too close, the aperture is set to a large opening, or the sensitivity is high.
- The flash output compensation is also effective for external flash units which support P-TTL auto flash mode.

Shooting with the Flash

1 Select a flash mode.

2 Slide the flash pop-up switch in the direction of the arrow.

The built-in flash pops up.

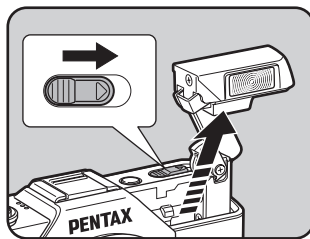

3 Press the shutter release button halfway.

The flash starts charging.

4 Press the shutter release button fully.

The picture is taken.

- 5** Push down in the direction of the arrow to retract the built-in flash.

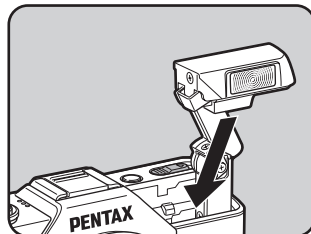

- The built-in flash discharges even when retracted, which may cause vignetting to occur depending on the lens being used. Vignetting may also occur at other times depending on the shooting conditions.
- Be sure to retract the built-in flash if not planning to use it. Be careful not to get your fingers pinched when retracting the flash.



- If you do not want to let the built-in flash discharge while it is retracted, set [10. Flash When Retracted] to [Do Not Discharge Flash] in the [C Custom Setting 2] menu.
- You cannot take pictures while the built-in flash is being charged. If you want to take pictures while charging the built-in flash, set [11. Release While Charging] to [On] in the [C Custom Setting 2] menu.

Playing Back Images

You can play back captured images with the camera.

1 Press the button.

The camera enters Playback mode and the most recently captured image (image with the highest file number) is displayed on the monitor. (For movies, only the first frame is displayed on the monitor.)

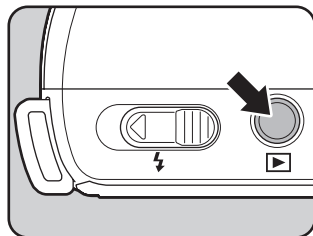

3

Basic Operations

2 Review the captured image on the monitor.

Available operations

Four-way controller (◀)/ E-dial to the left (⏮)	Displays the previous image.
Four-way controller (▶)/ E-dial to the right (⏭)	Displays the next image.
INFO button	Switches information display On/Off. (p.25)
 Av button	Saves the RAW image (only when the data is available).



- When the file format of the last captured image is JPEG, and its data still remains in the buffer memory, you can save the RAW image during Instant Review or playback.
If the image was shot using any of the following settings, the corresponding image listed is saved.
 - **BC** (Blur Control) mode RAW image with Blur Control disabled
 - Digital Filter RAW image without a filter effect
 - Smart Effect RAW image with [Bright] image finishing tone
 You cannot save RAW images during Continuous Shooting, Exposure Bracketing, Multi-exposure or HDR Capture.
- Refer to “Playback Functions” (p.145) for details on the playback mode functions.

Deleting a Single Image

You can delete images one by one.



- Deleted images cannot be restored.
- Protected images cannot be deleted. (p.194)

1 Press the button, and display the image to delete.

2 Press the button.
The delete confirmation screen appears.

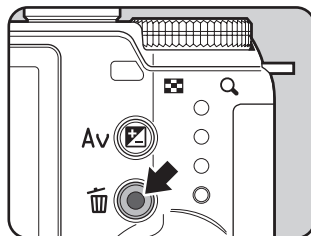

3 Press the four-way controller () to select [Delete].

Select a file format to delete for images saved in RAW+ format.

Delete JPEG	Deletes only the JPEG image.
Delete RAW	Deletes only the RAW image.
Delete RAW+JPEG	Deletes images in both file formats.

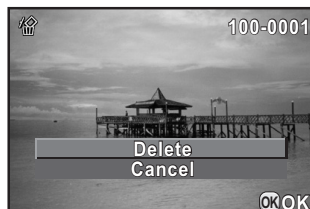

4 Press the **OK** button.

The image is deleted.



You can delete multiple images at once. Refer to “Deleting Multiple Images” (p.158) for details.

4 Shooting Functions

This chapter describes the various basic and advanced shooting functions available with this camera.

How to Operate the Shooting Functions	62
Selecting the Appropriate Capture Mode	67
Setting the Exposure	73
Focusing	84
Checking the Depth of Field (Preview)	92
Using the Shake Reduction Function to Prevent Camera Shake	93
Taking Pictures Continuously	99
Recording Movies	105

You can change capture-related settings using the direct keys, control panel, [📷 Rec. Mode] menu, [🎬 Movie] menu or [C Custom Setting] menu.



For details on how to use the direct keys and menus, refer to “How to Change Function Settings” (p.30)

Direct Keys Setting Items

Press the four-way controller (▲▼◀▶) in Capture mode to set the following items.

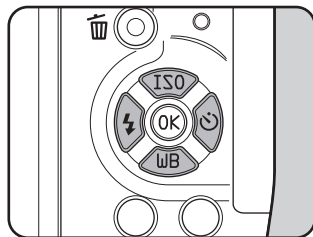



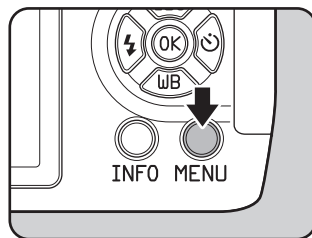

Key	Item	Function	Page
▲	Sensitivity	Sets the ISO sensitivity.	p.73
▼	White Balance	Adjusts the color balance to match the type of the light source illuminating the subject.	p.120
◀	Flash Mode	Sets the method of flash discharge.	p.55
▶	Drive Mode	Selects Continuous Shooting, Self-timer, Remote Control or Exposure Bracketing shooting.	p.99 p.95 p.96 p.78

Rec. Mode Menu Items

The following settings can be performed in the [📷 Rec. Mode 1-3] menus. Press the **MENU** button in Capture mode to display the [📷 Rec. Mode 1] menu.







Menu	Item	Function	Page	
📷1	Custom Image *1	Sets the image finishing tone such as color and contrast before shooting an image.	p.126	
	Digital Filter *1	Applies a digital filter effect when taking pictures.	p.130	
	Image Capture Settings	Aspect Ratio *1	Sets the horizontal and vertical ratio of images.	p.116
		File Format *1	Sets the file format.	
		JPEG Recorded Pixels *1	Sets the recording size of images saved in JPEG format.	
		JPEG Quality *1	Sets the quality of images saved in JPEG format.	
		Color Space	Sets the color space to use.	
	Focus Settings	Focus Method *1	Selects the autofocus or manual focus mode.	p.84
		Autofocus Method *1	Selects the autofocus method in AF mode.	p.85
		MF Assist	Enlarges the monitor display during manual focus and makes it easier to focus on the subject.	p.90
		Focus Peaking	Emphasizes the outline of the subject in focus and makes it easier to check the focus.	p.91
AE Metering *1	Selects the part of the sensor to use for measuring brightness and determining exposure.	p.82		
ND Filter *1	Sets whether to use the ND filter built-in to the lens.	p.142		

Menu	Item	Function	Page
	HDR Capture *1	Enables capturing images with high dynamic range.	p.125
	Multi-exposure	Creates a picture by taking multiple exposures and merging them into a single image.	p.103
	Interval Shooting	Takes pictures at a set interval from a set time.	p.101
	D-Range Setting *1	Expands the dynamic range and prevents bright and dark areas from occurring.	p.123 p.124
	High-ISO NR	Sets the Noise Reduction setting when shooting with a high ISO sensitivity.	p.83
	Distortion Correction	Reduces distortions occurring due to lens properties.	p.143
	Quick Dial	Assigns functions to the quick dial.	p.132
	Green Button	Assigns functions to the  /  button.	p.138
	LCD View Options	Sets the monitor display in Capture mode.	p.185
	Instant Review	Sets the Instant Review display settings.	p.186
	Memory	Determines which settings to save when the power is turned off.	p.189
	Shake Reduction *1	Activates the Shake Reduction function.	p.93
	Input Focal Length	Sets the focal length when using a lens for which focal length information cannot be obtained.	p.223

*1 Can be also set through the control panel.

Movie Menu Items

The following settings can be performed in the [ Movie 1] menu. Press the **MENU** button when the mode dial is set to  to display the [ Movie 1] menu.

Menu	Item	Function	Page
 1	Recorded Pixels *1	Sets the number of recorded pixels or size of the movie.	p.105
	Sound *1	Sets whether to record sound together with movies.	
	Exposure Setting	Sets whether to set the exposure manually.	
	Movie SR *1	Activates the Movie SR function.	
	Interval Movie	Takes still pictures at a set interval from a set time and records it as a single movie file.	p.109

*1 Can be also set through the control panel.

Custom Setting Menu Items

Set the [**C** Custom Setting 1-2] menus to fully use the functions of this camera.

Menu	Item	Function	Page
C1	1. AE-L with AF Locked	Sets whether to lock the exposure value when the focus is locked.	p.81
	2. Link AE to AF Point	Sets whether to link the exposure and AF point in the focusing area during multi-segment metering.	p.82
	3. Auto Bracketing Order	Sets the order for Exposure Bracketing shooting.	p.78
	4. Shake Reduction Options	Sets whether to use Shake Reduction during standby mode as well.	p.94
	5. WB When Using Flash	Sets the white balance setting when using flash.	p.121
	6. AWB in Tungsten Light	Sets whether to adjust the tungsten light color tone when the white balance is set to AWB (Auto White Balance).	—
	7. AF Release Options	Sets the action priority for when the shutter release button is fully pressed in AF mode.	p.86

Menu	Item	Function	Page
C2	8. AF Assist Light	Sets whether to use the AF assist light when autofocusing in dark locations.	p.85
	9. AF with Remote Control	Sets whether to use autofocus when shooting with remote control.	p.98
	10. Flash When Retracted	Sets whether to discharge the built-in flash when retracted.	p.58
	11. Release While Charging	Sets whether to release the shutter while the built-in flash is charging.	p.58
	12. Save Menu Location	Sets whether to save the last menu tab displayed on the monitor and to display it again the next time the MENU button is pressed.	p.186
	13. Electronic Shutter	Sets whether to use the electronic shutter when using a lens that has a lens shutter.	p.222
	Reset Custom Functions	Resets all the settings in the [C Custom Setting 1-2] menus to the defaults.	p.191

This camera features various capture modes, enabling you to take pictures with settings suited for your photographic vision. In this manual, the capture modes are referred to as follows.

Capture Mode	Mode	Page
AUTO (Auto Picture) mode	Automatically selects the optimal capture mode for the subject.	p.68
SCN (Scene) mode	You can choose the capture mode from various scene styles.	p.69
BC (Blur Control) mode	Takes pictures while emphasizing a blur effect.	p.71
Exposure modes (P/Tv/Av/M)	Changes the shutter speed and aperture value.	p.72
 (Movie) mode	Records a movie.	p.107

- 1 Turn the mode dial to set the desired capture mode on the mode dial to the dial indicator.

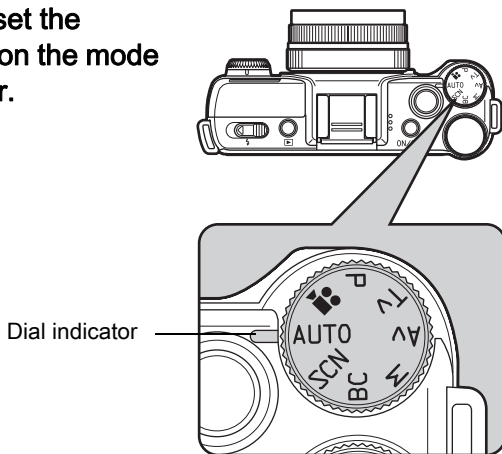

The selected capture mode is displayed on the monitor (Guide Display).













- Set the guide display time in [Guide Display] of the [Set-up 1] menu. (p.185)
- The scene mode selection screen appears when the mode dial is set to **SCN** (p.70)



















Auto Picture Modes





When set to **AUTO** (Auto Picture) mode, the camera automatically selects the optimal mode from the following capture modes for the subject.

Mode	Characteristics
 Standard	This is selected when none of the following modes apply.
 Portrait	For capturing portraits. Reproduces a healthy and bright skin tone.
 Landscape	For capturing landscape views. Increases color saturation and produces a vivid color image.
 Macro	For capturing tiny objects at close focus range like flowers, coins, jewelry, and more.
 Night Scene Portrait	For capturing images of people in low light conditions, such as dusk or at night. Even though the flash is used, the camera will use slow shutter speeds so the background areas beyond the flash reach will also appear correctly exposed in the picture (Ⓜ Slow-speed Sync (p.208)). To prevent camera shake, either use the Shake Reduction function or mount the camera on a tripod.
 Sunset	For capturing sunrises or sunsets in beautiful, vivid color.
 Blue Sky	For capturing images of blue sky. Produces a more impressive deep blue.
 Forest	Enhances colors of trees and sunbeams through foliage and produces a vivid color image.











Scene Modes

By setting the mode dial to **SCN** (Scene), you can choose from the following scene modes.

Mode	Characteristics
 Portrait	For capturing portraits. Reproduces a healthy and bright skin tone.
 Landscape	For capturing landscape views. Increases color saturation and produces a vivid color image.
 Macro	For capturing tiny objects at close focus range like flowers, coins, jewelry, and more.
 Moving Object	For capturing images of fast moving subjects, such as at sporting events. The drive mode is fixed to  (Continuous Shooting (Hi)).
 Night Scene Portrait	For capturing images of people in low light conditions, such as dusk or at night. Even though the flash is used, the camera will use slow shutter speeds so the background areas beyond the flash reach will also appear correctly exposed in the picture (Slow-speed Sync (p.208)). To prevent camera shake, either use the Shake Reduction function or mount the camera on a tripod.
 Sunset	For capturing sunrises or sunsets in beautiful, vivid color.
 Blue Sky	For capturing images of blue sky. Produces a more impressive deep blue.
 Night Scene	Used for shooting at night. Use a tripod or flat surface to prevent camera shake blur.
 Night Scene HDR	Generates a single HDR image with less noise from 3 images (-3 EV, Standard, and +3 EV) captured in dim lighting. The file format is fixed to [JPEG].
 Night Snap	For taking snapshots in poorly lit place.
 Food	For capturing images of food. Saturation will be rather high to make it look appetizing.
 Quick Macro	For quick capture of tiny objects at close focus range. This mode automatically adds Blur Control. The file format is fixed to [JPEG].
 Pet	For capturing moving pets. The drive mode is fixed to  (Continuous Shooting (Hi)).
 Kids	For capturing moving kids. Reproduces healthy and bright skin tone. The drive mode is fixed to  (Continuous Shooting (Hi)).
 Forest	Enhances colors of trees and sunbeams through foliage and produces a vivid color image.
 Surf & Snow	For capturing images of dazzling backgrounds, such as snowy mountains.

Mode	Characteristics
HDR HDR	Captures 3 images to generate a single HDR image and provides a wider dynamic range. The file format is fixed to [JPEG].
 Backlight Silhouette	Produces a silhouette image of subject in backlight condition.
 Candlelight	For capturing scenes in candlelight.
 Stage Lighting	For capturing moving subjects in poorly lit place.
 Museum	For capturing images in places where a flash is prohibited.



The flash mode is fixed to  (Flash Off) in , , , , **HDR**, , , , and . To prevent camera shake, either set [Shake Reduction] to  (On) or mount the camera on a tripod.

Selecting a Scene Mode

1 Set the mode dial to SCN.

The camera switches to the **SCN** mode, and the scene mode selection screen appears.

2 Use the four-way controller (▲▼◀▶) or e-dial to choose a scene mode, and press the OK button.

The camera is ready to take a picture.



- To change the scene mode, press the **INFO** button, and select [Scene Mode] in the control panel.
- When the **MENU** button is pressed while the mode dial is set to **SCN**, the item [Scene Mode] appears on the [Rec. Mode 1] menu. Press the four-way controller (▶) to display the Scene Mode selection screen and you can select a scene mode in the same way as described in Step 2.



Blur Control Mode

Blur Control enables you to create a picture that looks as if it was taken with a wide-open aperture and shallow depth of field, by shooting multiple images with different focus positions and merging them into a single image. This can produce a more noticeable blur effect that was difficult to achieve with conventional compact cameras.



In **BC** mode, images are captured using the following settings:

- Exposure control Open aperture priority
- Sensitivity Fixed to ISO AUTO
- File Format Fixed to JPEG

1 Set the mode dial to **BC**.

The camera switches to **BC** mode.



2 Turn the **e-dial**.

Select the level of blur from three levels.
Check the blur effect in the image by viewing it in Playback mode.

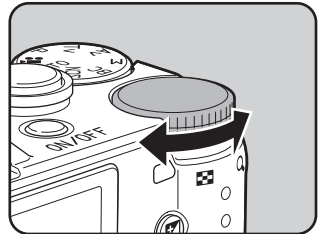



- Do not move the camera while taking a picture.
- If holding the camera by hand while shooting, set [Shake Reduction] to (On).
- Blur Control may not work as effectively as expected if a lens other than an AF lens is used.
- The following functions are not available with Blur Control:
 - Continuous Shooting, Remote Continuous Shooting, or Exposure Bracketing
 - Multi-exposure
 - HDR Capture
 - Smart Effect
 - Instant Review
- The blur effect may not turn out as well as expected in the following situations:
 - When the contrast is low overall
 - With fountains and other objects that change color or shape constantly
 - With moving objects
 - With small objects
 - With objects at the edge of the screen
 - With backlit scenes and other similar conditions
 - When a special filter is used
 - With far-off objects (Shooting at distances that produce portrait images from the chest up is recommended)

Exposure Modes

Use the exposure modes to change the shutter speed and aperture value and take pictures.

Mode	Characteristics	Page
P Program Automatic Exposure	Automatically sets the shutter speed and aperture value to obtain a proper exposure according to the Program line.	p.74
Tv Shutter Priority Automatic Exposure	Lets you set the desired shutter speed for expressing subject movement.	
Av Aperture Priority Automatic Exposure	Lets you set the desired aperture value for controlling the depth of field.	
M Manual Exposure	Lets you set the shutter speed and aperture value to match your photographic vision.	

Setting the Sensitivity

You can set the sensitivity to suit the brightness of the surroundings. The sensitivity can be set to [ISO AUTO] or within a sensitivity range equivalent to ISO 100 to 6400 in increments of 1/3 EV. The default setting is [ISO AUTO].

1 Press the four-way controller (▲) in Capture mode.

The Sensitivity setting screen appears.

2 Use the four-way controller (▲▼) to select [ISO AUTO] or [ISO].

ISO AUTO	Sets the range to be adjusted automatically.
ISO	Sets a fixed value.



3 Use the e-dial to change the sensitivity value.

4 Press the OK button.

The camera is ready to take a picture.



- When the capture mode is set to (Night Scene HDR)/ (Night Snap)/**HDR** (HDR)/ (Stage Lighting) of **SCN** (Scene) mode, the sensitivity is fixed to [ISO AUTO] and cannot be changed.
- [ISO AUTO] is not available in **M** mode. If the mode dial is set to **M** when the sensitivity is set to [ISO AUTO], the camera operates in **TA**v mode. (p.74)
- The minimum sensitivity is ISO 200 when [Highlight Correction] (p.123) is set to [On].
- Captured images may show more noise if a higher sensitivity is set. You can change the setting in [High-ISO NR] of the [Rec. Mode 2] menu. (p.83)

Changing the Exposure Mode

This camera features the following exposure modes.

The settings available for each exposure mode are as follows.

✓ : Available # : Restricted × : Not available

Exposure Mode	Change Shutter Speed	Change Aperture Value	Change Sensitivity	EV Compensation
P Program Automatic Exposure	#*1	#*1	✓	✓
Tv Shutter Priority Automatic Exposure	✓	×	✓	✓
Av Aperture Priority Automatic Exposure	×	✓	✓	✓
M Manual Exposure	✓	✓	✓*2	×

*1 In [Green Button] of the [📷 Rec. Mode 3] menu, you can make the setting so that the shutter speed and/or aperture value can be changed by turning the e-dial. (p.140)

*2 When the sensitivity is set to [ISO AUTO], the camera switches to **TA**v (Shutter & Aperture Priority Automatic Exposure) mode and the sensitivity is automatically set so that a proper exposure is obtained from the set shutter speed and aperture value. When the sensitivity is set to a fixed value, images are captured with the set sensitivity.

- 1 Set the mode dial to **P**, **Tv**, **Av** or **M**.

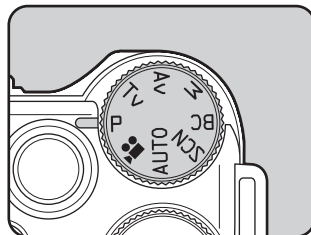

- 2 Turn the e-dial to adjust the value.

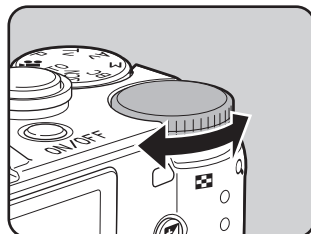

▶ appears on the monitor next to the value that can be changed.

The following parameters can be changed depending on the selected exposure mode.



P	Item set in [Green Button] of the [📷 Rec. Mode 3] menu (p.140)
Tv	Shutter speed
Av	Aperture value
M	Shutter speed

3

When set to **M** mode, press the **Av** button (①), and then turn the e-dial (②) to change the aperture value.

The exposure compensation value can be adjusted by this operation in **P/Tv/Av** mode. (p.77)

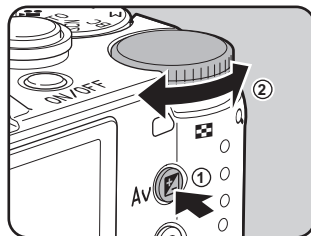

- A proper exposure may not be obtained with the selected shutter speed and aperture value when the sensitivity is set to the fixed value (p.73).
- In **M** mode, the difference from the proper exposure is displayed in a bar graph while the shutter speed or aperture value is adjusted. The exposure value is displayed in red when the difference from the proper exposure becomes ± 3.0 EV or larger.
- You can set the function of the button for when the exposure mode is set to **M**. Set in [Green Button] of the [📷 Rec. Mode 3] menu. (p.141)
- Sensitivity values higher than ISO 1600 are not available when the shutter speed is set to 2 sec. or slower in **Tv/M** mode.

Using the Bulb Shooting

This is useful when shooting night scenes and fireworks which require long exposures.

1 Set the mode dial to **M**.

2 Turn the e-dial to the left (☒), and set the shutter speed to **Bulb**.

Bulb appears after the slowest shutter speed.



3 Press the shutter release button.

The shutter remains open as long as the shutter release button is kept pressed.

4 Take your finger off the shutter release button.

Exposure ends.



- Bulb shooting is available only when using a lens that has a lens shutter.
- In Bulb shooting, the following functions are not available.
 - Continuous Shooting
 - Exposure Bracketing
 - EV Compensation
 - AE Lock
 - Interval Shooting
 - HDR Capture
 - Shake Reduction
- Bulb shooting ends compulsorily once the exposure time exceeds 32 seconds.



- Use a sturdy tripod to prevent camera shake during Bulb shooting.
- The upper sensitivity limit for Bulb shooting is ISO 1600.
- We recommend using the AC adapter kit (optional) when shooting with a long exposure setting as the battery drain is high during Bulb shooting. (p.40)

Adjusting the Exposure

This allows you to deliberately overexpose (brighten) or underexpose (darken) your picture.

The compensation value can be set in increments of 1/3 EV or 1/2 EV between -3 and +3 depending on the lens being used.

Step Interval	Exposure Setting Value
1/3 EV	$\pm 0.3, \pm 0.7, \pm 1.0, \pm 1.3, \pm 1.7, \pm 2.0, \pm 2.3, \pm 2.7, \pm 3.0$
1/2 EV	$\pm 0.5, \pm 1.0, \pm 1.5, \pm 2.0, \pm 2.5, \pm 3.0$

- 1** Press the  Av button (①), and then turn the e-dial (②).

The exposure is adjusted.

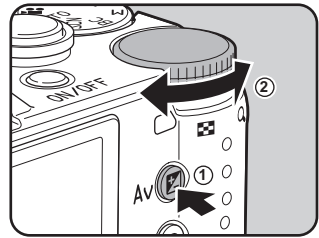



EV bar is displayed on the monitor during adjustment.



EV bar

Available operations

 Av button	Starts/ends selecting the compensation value.
 /  button	Resets the compensation value.



- EV Compensation is not available when the capture mode is set to **M** (Manual Exposure).
- The set compensation value is not canceled by turning the camera off or by switching to another capture mode.

Changing the Exposure Automatically when Shooting (Exposure Bracketing)

You can take three consecutive images at three different exposure levels when the shutter release button is pressed. Three images are saved with each release.



Standard exposure



Underexposure

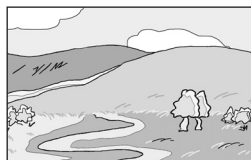

Overexposure

You can set the bracketing order in [3. Auto Bracketing Order] of the [C Custom Setting 1] menu.

0 - +	Standard → Underexposed → Overexposed (default setting)
- 0 +	Underexposed → Standard → Overexposed
+ 0 -	Overexposed → Standard → Underexposed
0 + -	Standard → Overexposed → Underexposed



Exposure Bracketing is not available in the following situations.

- when the capture mode is set to **BC** (Blur Control) mode, or (Moving Object)/ (Night Scene HDR)/ (Quick Macro)/ (Pet)/ (Kids)/**HDR** (HDR) or **SCN** (Scene) mode
- when the shutter speed is set to **Bulb**
- when Interval Shooting, Multi-exposure or HDR Capture is set



1

Press the four-way controller (▶) in Capture mode.



The Drive Mode setting screen appears.

2

Use the four-way controller (◀▶) to select .

- 3** Press the four-way controller (▼), and use the four-way controller (◀▶) to select  or .





	Exposure Bracketing	Takes pictures with the shutter release button.
	Exposure Bracket + Remote Ctrl	Takes pictures with an optional remote control unit. The remote control operates according to the Remote Control shooting (p.96) setting. The shutter is immediately released when set to  (Remote Continuous Shooting).

- 4** Press the four-way controller (▼), and turn the e-dial to set the bracket value.

The bracket value can be set in increments of 1/3 EV or 1/2 EV depending on the lens being used.

Step Interval	Bracket Value
1/3 EV	±0.3, ±0.7, ±1.0, ±1.3, ±1.7, ±2.0, ±2.3, ±2.7, ±3.0
1/2 EV	±0.5, ±1.0, ±1.5, ±2.0, ±2.5, ±3.0



Available operations

 Av button → e-dial	Adjusts the exposure compensation value (when taking only underexposed or overexposed images).
 /  button	Resets the compensation value.

- 5** Press the OK button.



The camera is ready to take a picture.





- When [Autofocus Method] (p.85) is set to [AF Select (25 Points)], [Select] or [Spot], the focus position is locked in the first image and is used for subsequent images.
- Switch to a mode other than  or  in the Drive Mode setting screen to cancel Exposure Bracketing. The setting is canceled when the camera is turned off if [Drive Mode] is set to □ (Off) in [Memory] of the [Rec. Mode 3] menu. (p.189)
- You can combine Exposure Bracketing with the built-in flash or an external flash (P-TTL auto only) to change only the flash output continuously.



Locking the Exposure Before Shooting (AE Lock)

AE Lock is a function that locks the exposure (brightness) prior to taking a picture. Use this when the subject is too small to obtain a proper exposure or is backlit.

First, assign the AE Lock function to the / button.



- 1 Select [Green Button] in the [ Rec. Mode 3] menu, and press the four-way controller ().

The [Green Button] screen appears.

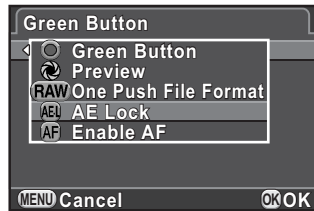
- 2 Press the four-way controller (), use the four-way controller ( ) to select [AE Lock], and press the OK button.



- 3 Press the MENU button twice.

The AE Lock function is assigned to the / button and the camera is ready to take a picture.

- 4 Set the exposure, and press the / button.

The camera locks the exposure at that instant.

* is displayed on the monitor while AE Lock is engaged.

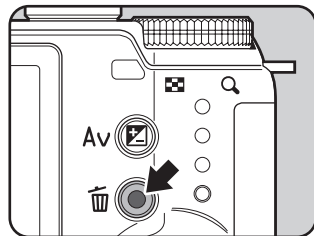





- The exposure remains locked as long as the button is kept pressed or the shutter release button is kept pressed halfway.
- You will hear a beep when AE Lock is activated. The beep can be turned off. (p.180)
- When any of the following operations are performed, AE Lock is canceled.
 - the button is pressed again
 - the button, **MENU** button, or power switch is pressed
 - the mode dial is turned
 - the lens is changed
- AE Lock is not available when the shutter speed is set to **Bulb**.
- The exposure is also locked when the focus is locked. If you do not want to lock the exposure when the focus is locked, set [1. AE-L with AF Locked] of the [**C** Custom Setting 1] menu to [Off].
- When the shutter speed or aperture value is changed while AE Lock is engaged in **M** (Manual Exposure) mode, the combination of shutter speed and aperture value changes while the exposure remains the same. For example, when the shutter speed is 1/125 sec. and aperture is F4 and these settings are locked, the aperture automatically changes to F8 if the shutter speed is changed to 1/30 sec.
- When using a zoom lens whose maximum aperture varies depending on the focal length, the combination of shutter speed and aperture value changes depending on the zooming position even while AE Lock is engaged. However, the exposure value does not change and a picture is taken at a brightness level set when AE Lock is activated.

Selecting the Metering Method

Choose the part of the sensor to use for measuring brightness and determining exposure.

 Multi-segment	<p>The sensor meters the brightness in multiple different zones. (default setting)</p> <p>Even in backlit locations, this mode automatically determines what level of brightness is in which portion and automatically adjusts exposure.</p>
 Center-weighted	<p>Metering is weighted at the center of the sensor.</p> <p>The sensitivity increases at the center and no automatic adjustment is performed even during backlit scenes.</p>
 Spot	<p>The brightness is measured only within a limited area at the center of the sensor.</p> <p>You can use this in combination with the AE Lock function (p.80) when the subject is extremely small and a correct exposure is difficult to obtain.</p>

1 Press the **INFO** button in Capture mode.

The control panel appears.

2 Use the four-way controller (▲▼◀▶) to select [AE Metering], and press the **OK** button.

The [AE Metering] screen appears.

3 Use the four-way controller (◀▶) to select a metering method, and press the **OK** button.

The camera returns to the control panel.

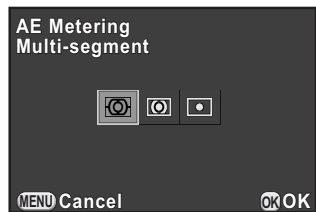

- You can also change the setting from the [📷 Rec. Mode 1] menu.
- In [2. Link AE to AF Point] of the [C Custom Setting 1] menu, you can link the exposure and AF point in the focusing area during multi-segment metering.

Off	Exposure for multi-segment metering is determined regardless of the AF point. (default setting)
On	Exposure for multi-segment metering is adjusted according to the AF point.

Reducing Image Noise (Noise Reduction)

When shooting with a digital camera, image noise (image roughness or unevenness) becomes noticeable in the following situations.

- when shooting with a long exposure
- when shooting with a high sensitivity setting
- when the temperature of the CMOS sensor is high

You can reduce image noise by using Noise Reduction.

High-ISO NR

Reduces noise at high sensitivity (ISO) settings.

- 1 Select [High-ISO NR] in the [📷 Rec. Mode 2] menu, and press the four-way controller (▶).
- 2 Use the four-way controller (▲▼) to select [Auto], [Low] or [High], and press the **OK** button.

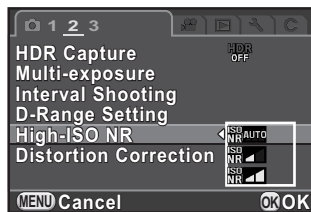

Auto	Applies Noise Reduction at optimally calculated levels throughout ISO range. (default setting)
Low/High	Applies Noise Reduction at constant chosen level throughout ISO range.

- 3 Press the **MENU** button.

The camera is ready to take a picture.



The card access lamp blinks and the camera cannot be operated during Noise Reduction.

Setting the Focus Method

You can focus with the following methods.

AF Autofocus	The camera automatically focuses on the subject when the shutter release button is pressed halfway.
MF Manual focus	Manually adjust the focus.

1 Press the **INFO** button in Capture mode.

The control panel appears.

2 Use the four-way controller (▲▼◀▶) to select [Focus Method], and press the **OK** button.

The [Focus Method] screen appears.

3 Use the four-way controller (◀▶) to select a focus method, and press the **OK** button.

The camera returns to the control panel.

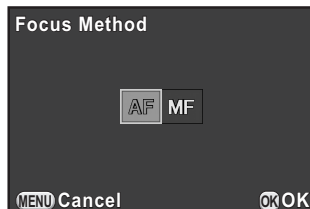

Refer to “Letting the Camera Choose the Optimal Settings” (p.52) for information on how to take pictures in **AF** mode.

Refer to “Adjusting the Focus Manually (Manual Focus)” (p.90) for information on how to take pictures in **MF** mode.



- You can also change the setting from the [Focus Settings] of the [📷 Rec. Mode 1] menu.
- [Focus Method] is fixed to **AF** when the capture mode is set to **AUTO** (Auto Picture) or **BC** (Blur Control) mode, or 📷 (Portrait)/ 📷 (Moving Object)/ 📷 (Night Scene Portrait)/ 📷 (Night Snap)/ 📷 (Quick Macro)/ 📷 (Pet)/ 📷 (Kids)/ 📷 (Stage Lighting) of **SCN** (Scene) mode.
- In **AF** mode, when the subject is in a dark location, the AF assist light is used when the shutter release button is pressed halfway. To not use the AF assist light, set [8. AF Assist Light] to [Off] in the [C Custom Setting 2] menu.

Setting the Autofocus Method

You can choose from the following five autofocus methods in **AF** mode.

	Face Detection	Detects and tracks faces of people. The main face detection frame for autofocus and auto exposure is displayed in yellow.
	Tracking	Tracks the subject in focus when the shutter release button is pressed halfway. The shutter is released by pressing the shutter release button fully even if the subject is not in focus.
	AF Select (25 Points)	Sets the focusing area to the desired area. (default setting) The sensor is divided into 25 areas (5 horizontal by 5 vertical), and you can select a wider or narrower focusing area by using 25, 9, 5, 3 or just 1 of those 25 areas available. (p.87)
	Select	Sets the focusing area by the number of pixels. You can select a setting more detailed than [AF Select (25 Points)].
	Spot	Sets the focusing area to a limited area at the center.

1 Press the INFO button in Capture mode.

The control panel appears.

2 Use the four-way controller (▲ ▼ ◀ ▶) to select [Autofocus Method], and press the OK button.

The [Autofocus Method] screen appears.

3 Use the four-way controller (◀▶) to select an autofocus method, and press the OK button.

The camera returns to the control panel.

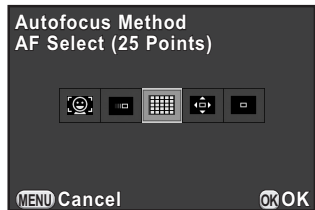

- You can also change the setting from the [Focus Settings] of the [📷 Rec. Mode 1] menu.
- [Autofocus Method] is fixed to when the capture mode is set to **AUTO** (Auto Picture), or (Portrait)/ (Night Scene Portrait)/ (Kids) of **SCN** (Scene) mode.
- [Autofocus Method] is fixed to when the capture mode is set to (Moving Object)/ (Night Snap)/ (Pet)/ (Stage Lighting) of **SCN** (Scene) mode.
- In [AF Select (25 Points)], [Select] or [Spot] mode, you can take pictures by fully pressing the shutter release button only when the subject is in focus. To take pictures when the subject is not in focus, set [7. AF Release Options] to [Release-priority] in the [C Custom Setting 1] menu.

Selecting the Desired Focusing Area

You can set the position and range of the autofocusing area (AF area).

- 1** Select [AF Select (25 Points)] or [Select] in Step 3 on p.86, and press the **OK** button.

The camera returns to the control panel.

- 2** Press the **MENU** button or the shutter release button halfway.

The camera is ready to take a picture.

- 3** Press the **OK** button.

A black rectangle appears on the monitor, and the AF area can be set by changing the position and size of this rectangle.

- 4** Select the AF area.

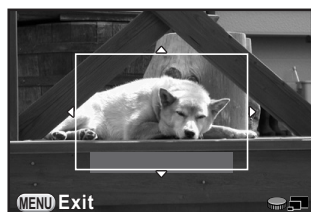

Available operations

Four-way controller (▲▼◀▶)	Changes the position of the AF area.
E-dial to the right (Q)	Increases the size of the AF area (when [AF Select (25 Points)] is selected).
E-dial to the left (E)	Reduces the size of the AF area (when [AF Select (25 Points)] is selected).
OK button	Returns the AF area to the center.



- 5** Press the **MENU** button.



The AF area is set.





The set AF area remains in the memory even if the autofocus method is changed or the camera is turned off.



Focusing Using the / Button

You can set the camera to perform focusing by pressing the / button. Use this setting when activating the autofocus by pressing the shutter release button halfway is not desired.

First, assign the Enable AF function to the / button.



- 1 Select [Green Button] in the [ Rec. Mode 3] menu, and press the four-way controller ().

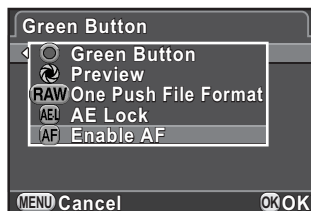

The [Green Button] screen appears.

- 2 Press the four-way controller () , use the four-way controller ( ) to select [Enable AF], and press the OK button.









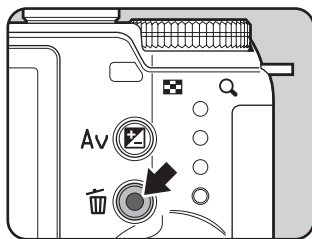

- 3 Press the MENU button twice.

Enable AF is assigned to the / button and the camera is ready to take a picture.

- 4 While viewing the subject on the monitor, press the / button.

The autofocus system operates.



- When Enable AF is assigned to the / button, the autofocus by pressing the shutter release button halfway is disabled.
- If Enable AF is assigned to the / button when the capture mode is set to BC (Blur Control) mode or  (Quick Macro) of SCN (Scene) mode, use the / button to make sure before shooting that a subject is in focus. The desired blur effect cannot be achieved if the subject is not in focus.

Locking the Focus (Focus Lock)

If the subject is outside of the focusing area, the camera cannot automatically focus on the subject. In this case, focus the camera on the subject in the focusing area, lock the focus at that position (Focus Lock), and then recompose your picture.

1 Set [Focus Method] to AF.

Refer to “Setting the Focus Method” (p.84) for details.

2 Set [Autofocus Method] to [AF Select (25 Points)], [Select], or [Spot].

Refer to “Setting the Autofocus Method” (p.85) for details.

3 Frame the desired composition for your picture on the monitor.

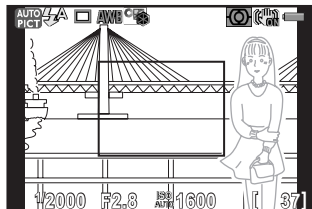

Example) The person is out of focus and the background is in focus instead.

4 Center the main subject on the monitor and press the shutter release button halfway.

The AF frame turns green when focused. The focus is locked while the AF frame is green.

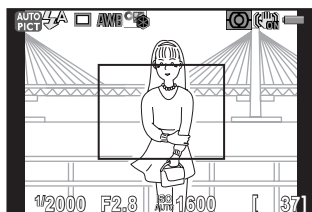

5 Recompose the picture while keeping the shutter release button pressed halfway.

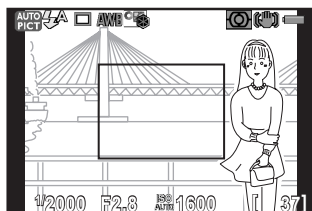



- Turning the zoom ring with the focus locked may cause the subject to be out of focus.
- You cannot lock the focus when the capture mode is set to (Moving Object)/ (Night Snap)/ (Pet)/ (Kids)/ (Stage Lighting) or **SCN** (Scene) mode. In such cases, the autofocus continues to focus on the subject until the shutter is released (Continuous Autofocus).

Adjusting the Focus Manually (Manual Focus)

Manually adjust the focus.

1 Set [Focus Method] to MF.

Refer to “Setting the Focus Method” (p.84) for details.

2 While viewing the monitor, turn the focusing ring.

The shutter can be released by pressing the shutter release button fully even if the subject is not in focus.

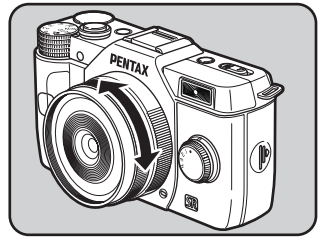

Focusing with the Image Enlarged

You can more easily focus on the subject by enlarging the image in the center of the monitor during **MF** mode.

1 Select [Focus Settings] in the [Rec. Mode 1] menu, and press the four-way controller (▶).

The [Focus Settings] screen appears.

2 Use the four-way controller (▲ ▼) to select [MF Assist], and press the four-way controller (▶).

- 3** Set the magnification to [Off], [x2], or [x4], and press the **OK** button.

The magnification can be changed with the e-dial while the image is enlarged.

- 4** Press the **MENU** button twice.

MF Assist is set and the camera is ready to take a picture.

- 5** Turn the focusing ring, or press the **OK** button.

The image on the monitor is enlarged.

- 6** Check that the subject is in focus.



Available operations

E-dial to the right (Q) Enlarges the image (up to 4 times).

E-dial to the left (Q) Reduces the image (up to 1 times).

Four-way controller (▲▼◀▶) Changes the area to display.

OK button Changes the display area to the center.

If any button other than the four-way controller (▲▼◀▶) is pressed, or if no operations are made within 30 seconds, the camera returns to normal display.



When [Focus Peaking] is set to [On] in [Focus Settings] of the [Rec. Mode 1] menu, the outline of the subject in focus is emphasized and makes it easier to check the focus. If you switch to **AF** mode after enabling Focus Peaking in **MF** mode, Focus Peaking also works in **AF** mode.



Checking the Depth of Field (Preview)

You can check the depth of field by stopping down the aperture of the lens to the actually set value.

First, assign the Preview function to the  button.

- 1** Select [Green Button] in the [📷 Rec. Mode 3] menu, and press the four-way controller ().

The [Green Button] screen appears.

- 2** Press the four-way controller (, , ) to select [Preview], and press the OK button.

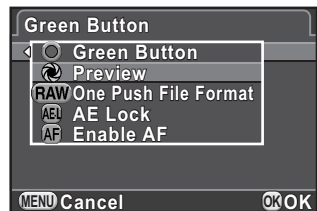

- 3** Press the MENU button twice.

The Preview function is assigned to the  button and the camera is ready to take a picture.

- 4** While viewing the subject on the monitor, press the  button.

You can check the depth of field on the monitor while the  button is pressed.

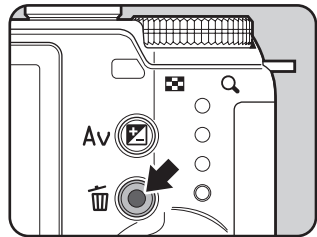

- 5** Take your finger off the  button.

Preview is ended and the camera is ready to take a picture.



The Preview function is not available when the aperture of the lens attached cannot be controlled by the camera.

Taking Pictures Using the Shake Reduction Function

The Shake Reduction function reduces camera shake that occurs when the shutter release button is pressed.

The Shake Reduction function works effectively when taking pictures in the following situations.

- When taking pictures in dimly lit locations, such as indoors, at night, on cloudy days and in the shade
- When taking telephoto pictures



- The Shake Reduction function does not compensate for blurring caused by subject movement. To take pictures of a moving subject, increase the shutter speed.
- The Shake Reduction function may not fully reduce camera shake when taking close-up shots. In this case, it is recommended to turn off the Shake Reduction function and use the camera with a tripod.
- The Shake Reduction function will not fully work when shooting with a very slow shutter speed, for example when panning or shooting night scenes. In this case, it is recommended to turn off the Shake Reduction function and use the camera with a tripod.

1 Press the **INFO** button in Capture mode.

The control panel appears.



2 Use the four-way controller (▲▼◀▶) to select [Shake Reduction], and press the **OK** button.

The [Shake Reduction] screen appears.

3 Use the four-way controller (◀▶) to select or , and press the **OK** button.

The camera returns to the control panel.



	Uses Shake Reduction. (default setting)
	Does not use Shake Reduction.

4 Press the shutter release button halfway.

☞ appears on the monitor and the Shake Reduction function is activated.





Be sure to turn the Shake Reduction function off when using the camera with a tripod.





- You can also change the setting from the [Rec. Mode 3] menu.
- [Shake Reduction] is fixed to ☞ in the following situations.
 - Self-timer shooting
 - Remote Control shooting
 - when the shutter speed is set to **Bulb**
- [Shake Reduction] is fixed to ☞ when the capture mode is set to **Night Scene HDR** or **HDR (HDR)** of **SCN (Scene)** mode.
- You can select whether to use the Shake Reduction function only when taking pictures or during standby mode as well with [4. Shake Reduction Options] from the [C Custom Setting 1] menu.
- The Shake Reduction function will not fully work (for about 2 seconds) right after turning on the camera or restoring from Auto Power Off. Wait for the Shake Reduction function to work stably and properly, and then press the shutter release button gently.
- The Shake Reduction function is available with any PENTAX Q-mount lens compatible with this camera. However, manually set the focal length in cases where the focal length cannot be automatically obtained, such as when a mount adapter is being used. Refer to "Using a K-Mount Lens" (p.223) for details.

Shooting with Self-timer

 Self-timer (12 sec.)	The shutter is released after about 12 seconds. Use this mode to include the photographer in the picture.
 Self-timer (2 sec.)	The shutter is released about 2 seconds after the shutter release button is pressed. Use this mode to avoid camera shake when the shutter release button is pressed.



The self-timer shooting is not available when the capture mode is set to  (Moving Object)/ (Pet)/ (Kids) of SCN (Scene) mode.

- 1** Mount the camera onto a tripod.
- 2** Press the four-way controller (▶) in Capture mode.
The Drive Mode setting screen appears.
- 3** Use the four-way controller (◀▶) to select .
- 4** Press the four-way controller (▼), use the four-way controller (◀▶) to select  or , and press the **OK** button.
The camera is ready to take a picture.



- 5** Press the shutter release button halfway.
The autofocus system operates.

6 Press the shutter release button fully.





For , the self-timer lamp starts blinking slowly and then blinks rapidly 2 seconds before the shutter is released. The beep is heard and the rate increases.

The shutter will be released about

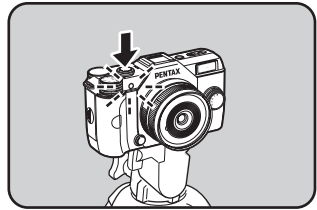
12 seconds after the shutter release button is pressed fully.



For , the shutter will be released about 2 seconds after the shutter release button is pressed.









- Select a mode other than  or  in the Drive Mode setting screen to cancel the self-timer shooting. The setting is canceled when the camera is turned off if [Drive Mode] is set to (Off) in [Memory] of the  [Rec. Mode 3] menu. (p.189)
- The Shake Reduction function is automatically turned off when  or  is set.
- You can set the camera so that the beep does not sound. (p.180)

Shooting with Remote Control (Optional)



The shutter can be released from a distance by using an optional remote control unit.

 Remote Control	The shutter is released immediately after the shutter release button on the remote control unit is pressed.
 Remote Control (3s delay)	The shutter is released about 3 seconds after the shutter release button on the remote control unit is pressed.
 Remote Continuous Shooting	Continuous shooting starts when the shutter release button on the remote control unit is pressed. Continuous shooting ends when the shutter release button on the remote control unit is pressed again.



- The remote control shooting is not available in the following situations.
 - when the capture mode is set to  (Moving Object)/ (Pet)/ (Kids) of **SCN** (Scene) mode
 - when the shutter speed is set to **Bulb**
 - when HDR Capture is set
-  cannot be selected when the capture mode is set to **BC** (Blur Control) mode, or  (Night Scene HDR)/ (Quick Macro)/**HDR** (HDR) of **SCN** (Scene) mode.

- 1** Mount the camera onto a tripod.
- 2** Press the four-way controller (▶) in Capture mode.
The Drive Mode setting screen appears.
- 3** Use the four-way controller (◀▶) to select .

- 4** Press the four-way controller (▼), use the four-way controller (◀▶) to select ,  or , and press the OK button.

The self-timer lamp on the front of the camera will blink and the camera is in a stand-by status.



- 5** Press the shutter release button halfway.

The autofocus system operates.

- 6** Point the remote control unit towards the remote control receiver on the front or back of the camera, and press the shutter release button on the remote control unit.

The maximum operating distance of the remote control unit is approximately 4 m from the front of the camera and approximately 5 cm from the back of the camera.

After a picture is taken, the self-timer lamp lights for 2 seconds and then returns to blinking.

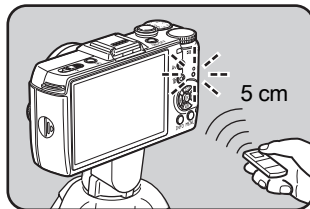
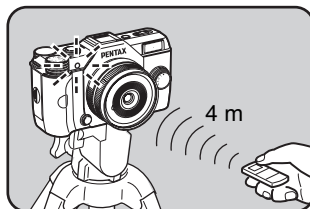







- By default, you cannot adjust the focus with the remote control unit. Focus on the subject first with the camera before operating with the remote control unit. When [9. AF with Remote Control] is set to [On] in the [C Custom Setting 2] menu, you can use the remote control unit to adjust the focus.
- Select a mode other than , or in the Drive Mode setting screen to cancel the remote control shooting. The setting is canceled when the camera is turned off if [Drive Mode] is set to (Off) in [Memory] of the [Rec. Mode 3] menu. (p.189)
- The Shake Reduction function is automatically turned off when , or is set.
- The remote control shooting may not be available in backlit conditions.
- When using the Remote Control Waterproof O-RC1, the autofocus system can be operated with the button. The **Fn** button cannot be used.
- The Remote Control F can send a remote control signal about 30,000 times. Contact a PENTAX Service Center to replace the battery (this will involve a fee).

Continuous Shooting

Pictures can be taken continuously while the shutter release button is kept pressed.

 Continuous Shooting (Hi)	For JPEG images of 12M/★★★★ , up to approximately 5 frames per second can be taken continuously. You can capture up to approximately 5 frames at once. Not available when [File Format] is set to [RAW] or [RAW+].
 Continuous Shooting (Lo)	For JPEG images of 12M/★★★★ , up to approximately 1.5 frames per second can be taken continuously. You can capture up to approximately 100 frames at once.



- Continuous Shooting is not available in the following situations.
 - when the capture mode is set to  (Night Scene HDR) or **HDR** (HDR) or **SCN** (Scene) mode
 - when the shutter speed is set to **Bulb**
 - when HDR Capture is set
- You cannot save RAW data for JPEG images during Instant Review or playback when  or  is selected.
- The number of recordable images is reduced when [Aspect Ratio] is set to **16:9**, **3:2**, or **1:1** instead of **4:3**.

1 Press the four-way controller (▶) in Capture mode.

The Drive Mode setting screen appears.

2 Use the four-way controller (◀▶) to select .

3 Press the four-way controller (▼), use the four-way controller (◀▶) to select or , and press the OK button.

The camera is ready to take pictures continuously.



4 Press the shutter release button halfway.

The autofocus system operates.

5 Press the shutter release button fully.

Pictures are taken continuously while the shutter release button is fully pressed. Take your finger off the shutter release button to stop.



- The drive mode is fixed to when the capture mode is set to (Moving Object)/ (Pet)/ (Kids) of **SCN** (Scene) mode.
- The focus position is locked in the first frame.
- If [File Format] is changed to [RAW] or [RAW+] while is selected, the shooting mode is temporarily changed to .
- The shutter cannot be released until charging is complete when using the built-in flash. You can set the camera to enable the shutter release before the built-in flash is ready in [11. Release While Charging] of the [**C** Custom Setting 2] menu.
- Select a mode other than or in the Drive Mode setting screen to cancel the continuous shooting. The setting is canceled when the camera is turned off if [Drive Mode] is set to (Off) in [Memory] of the [Rec. Mode 3] menu. (p.189)

Interval Shooting

Takes pictures at a set interval from a set time.
The following settings can be performed.

Interval	For taking two or more pictures, set the wait time until the next picture is taken from 1 second to 24 hours.
Number of Shots	Set the number of shots to be taken from 1 to 999. When [Start Interval] is set to [Now], you can select two or more pictures.
Start Interval	Select whether to take the first picture now or at a set time. Selecting [Now] starts recording immediately. When [Set Time] is selected, set [Start Time].
Start Time	Set the time at which to start shooting.



- Interval Shooting is not available in the following situations.
 - when the capture mode is set to **BC** (Blur Control) or (Movie) mode, or (Night Scene HDR)/ (Quick Macro)/**HDR** (HDR) of **SCN** (Scene) mode
 - when the shutter speed is set to **Bulb**
 - when Exposure Bracketing, Multi-exposure or Digital Filter is set
- When HDR Capture (p.125) is set, the shooting interval cannot be set to 9 seconds or less.

1 Select [Interval Shooting] in the [Rec. Mode 2] menu, and press the four-way controller (▶).

The [Interval Shooting] screen appears.

2 Use the four-way controller (▲▼) to select [Interval], and press the four-way controller (▶).

3 Use the four-way controller (◀▶) to select hours, minutes, or seconds, and use the four-way controller (▲▼) to set the time.

Press the **OK** button to finish the setting.

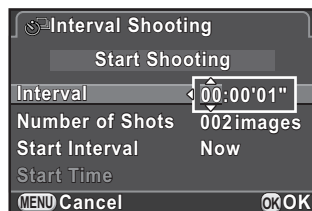

4 Use the four-way controller (▲▼) to select [Number of Shots], and press the four-way controller (▶).

5 Use the four-way controller (◀▶), and use the four-way controller (▲▼) to select the number of shots to be taken. Press the **OK** button to finish the setting.

6 Use the four-way controller (▲▼) to select [Start Interval], and press the four-way controller (▶).

7 Use the four-way controller (▲▼) to select [Now] or [Set Time], and press the **OK** button.
If you selected [Now], proceed to Step 10.

8 Use the four-way controller (▲▼) to select [Start Time], and press the four-way controller (▶).

9 Use the four-way controller (◀▶) to select hours or minutes, and use the four-way controller (▲▼) to set the time. Press the **OK** button to finish the setting.

10 Use the four-way controller (▲▼) to select [Start Shooting], and press the **OK** button.
The camera is ready to take a series of interval pictures.

11 Press the shutter release button halfway.
The autofocus system operates.
The focus during Interval Shooting is locked at this position.

12 Press the shutter release button fully.
When [Start Interval] is set to [Now], the first picture is taken.
When set to [Set Time], shooting starts at the set time.
For shooting multiple pictures, pictures are taken at the interval set in Step 3.
To cancel shooting, press the **MENU** button.
After the set number of pictures are taken, the camera returns to normal Capture mode.



- Refer to “Interval Movie” (p.109) for information on how to perform interval shooting in (Movie) mode.
- If any of the following operations are performed while shooting, the pictures that have been already taken are saved and Interval Shooting is ended.
 - when the power switch is pressed
 - when the mode dial or quick dial is turned
- (Single Frame Shooting) is used regardless of the current drive mode setting.
- Although each shot taken is displayed with Instant Review, they cannot be magnified, deleted, or saved in RAW format.
- If the Auto Power Off function turns the camera off before starting Interval Shooting, the camera automatically turns on again when the shooting time approaches.



- When using Interval Shooting, use the AC adapter kit (optional) or install a fully charged battery. If the battery is not sufficiently charged, it may become depleted during Interval Shooting, and cause recording to stop.
- Interval Shooting is canceled when the SD Memory Card has no more available space.

Multi-exposure

You can create a picture by taking multiple exposures and merging them into a single image.



- Multi-exposure is not available in the following situations.
 - when [File Format] is set to [RAW] or [RAW+]
 - when the capture mode is set to **BC** (Blur Control) or (Movie) mode, or (Night Scene HDR)/ (Quick Macro)/**HDR** (HDR) of **SCN** (Scene) mode
 - when Exposure Bracketing, Interval Shooting, HDR Capture or Digital Filter is set
- Distortion Correction is not available.

1

Select [Multi-exposure] in the [Rec. Mode 2] menu, and press the four-way controller (▶).

The [Multi-exposure] screen appears.

2

Use the four-way controller (▲▼) to select [Number of Shots], and press the four-way controller (▶).

- 3** Use the four-way controller (▲▼) to select the number of shots, and press the **OK** button.

Select from 2 to 9 shots.

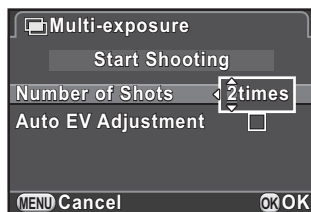

- 4** Use the four-way controller (▲▼) to select [Auto EV Adjustment], and use the four-way controller (◀▶) to select or .

When set to (On), the exposure is adjusted automatically according to the number of shots.

- 5** Use the four-way controller (▲▼) to select [Start Shooting], and press the **OK** button.

The camera is ready to take a series of interval pictures.

- 6** Press the shutter release button halfway.



The autofocus system operates.

- 7** Press the shutter release button fully.

The composite picture is displayed in Instant Review each time the shutter release button is pressed.

The following operations can be performed during Instant Review.

Available operations

 /  button	Discards pictures taken up to that point and takes pictures again from the first frame.
--	---

MENU button	Saves pictures taken up to that point and cancels shooting.
--------------------	---

When the above operations are performed or after the set number of shots are taken, the screen in Step 3 appears again.

- 8** Press the **MENU** button twice.

Multi-exposure is ended.

In this camera, you can record movies with the following format.

- Frame rate 30 fps
- Sound Monaural
- File format MPEG-4 AVC/H.264 (File extension: .MOV)

Changing the Settings for Movie Recording

Settings for recording movies can be changed using the [Movie] menu or the control panel.

Below, how to change the settings from the [Movie 1] menu is explained as an example.

1 Set the mode dial to , and press the MENU button.

The [Movie 1] menu appears.

Press the four-way controller (▶) three times if you press the **MENU** button in any other capture mode.

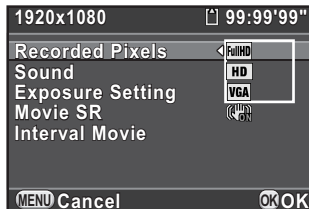

2 Press the four-way controller (▼), and then press the four-way controller (▶). Use the four-way controller (▲▼) to select the number of recorded pixels, and press the OK button.





Frame Size	Pixels	Aspect Ratio
(default setting)	1920×1080	
	1280×720	
	640×480	

When the number of recorded pixels is changed, the amount of recordable time for that setting appears at the top right of the screen.

3 Use the four-way controller (▲▼) to select [Sound], and press the four-way controller (▶).

- 4** Use the four-way controller (▲▼) to select  or , and press the **OK** button.

	Records sound. (default setting)
	Does not record sound.



- 5** Use the four-way controller (▲▼) to select [Exposure Setting], and press the four-way controller (▶).

- 6** Use the four-way controller (▲▼) to select [Auto] or [Manual], and press the **OK** button.

Auto	Takes pictures with auto exposure. (default setting)
Manual	Allows you to set the shutter speed, aperture value, and sensitivity.

- 7** Use the four-way controller (▲▼) to select [Movie SR], and press the four-way controller (▶).

- 8** Use the four-way controller (▲▼) to select  or , and press the **OK** button.

	Uses Shake Reduction. (default setting)
	Does not use Shake Reduction.

- 9** Press the **MENU** button.

The camera is ready to record a movie.



[Recorded Pixels], [Sound], and [Movie SR] can also be changed using the control panel.

Recording Movies

1 Set the mode dial to .

The movie recording screen appears.



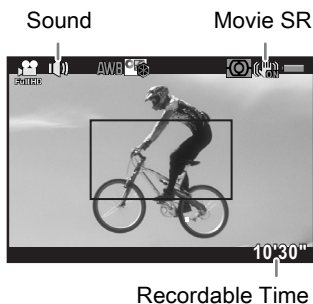

2 View the subject on the monitor.

Adjust the exposure when [Exposure Setting] is set to [Manual].



Recordable Time

Available operations

E-dial	Not available (when [Exposure Setting] is set to [Auto]) Adjusts the shutter speed (when [Exposure Setting] is set to [Manual]).
 Av button → e-dial	Adjusts the exposure compensation value (when [Exposure Setting] is set to [Auto]). Adjusts the aperture value (when [Exposure Setting] is set to [Manual]).
 /  button	Calls the function set in [Green Button] of the [Rec. Mode 3] menu (p.138; [Preview] and [One Push File Format] are not available.). Resets the exposure setting when [Exposure Setting] is set to [Manual] (if [Green Button] is assigned to the  /  button).

3 Press the shutter release button halfway.

The autofocus system operates.

When [Focus Method] is set to **MF**, turn the focusing ring until the subject is clearly visible on the focusing screen.

4 Press the shutter release button fully.

Movie recording starts.

A red ● displayed at the top right of the screen blinks during movie recording.

The following operations can be performed while recording a movie.

Available operations

OK button	Performs autofocus.
⊙/⌂ button	Locks the exposure (when [AE Lock] is assigned to the ⊙/⌂ button in [Green Button] of the [📷 Rec. Mode 3] menu). Performs autofocus (when [Enable AF] is assigned to the ⊙/⌂ button in [Green Button] of the [📷 Rec. Mode 3] menu).

5 Press the shutter release button again.

Movie recording stops.



- When [Sound] is set to 🗣️ (On), the camera operation sounds are also recorded. When recording a movie, mount the camera onto a tripod and do not operate the camera while recording.
- The flash is not available.
- When recording a movie using any image processing function, such as Digital Filter, some frames may be omitted from the recorded movie file.
- If the internal temperature of the camera becomes high during movie recording, the recording may be terminated to protect the camera circuitry.



- When recording a movie, regardless of the focus method setting, recording starts when the shutter release button is pressed fully even if the subject is not in focus.
- You can record a movie continuously up to 4 GB or 25 minutes. When the SD Memory Card is full, recording stops and the movie is saved.
- The screen display in 📷 mode is set according to the [LCD View Options] setting made in the [📷 Rec. Mode 3] menu. (p.185) However, the histogram and Bright/Dark Area warning are not displayed during movie recording.
- If you intend to record movies continuously for a long period, use of the AC adapter kit (optional) is recommended. (p.40)
- You can also use an optional remote control unit to start recording a movie. (p.96) Press the four-way controller (▶) in 📷 mode to display the screen for selecting on/off for the use of the remote control, instead of the normal Drive Mode setting screen. (To stop recording, press the shutter release button of the camera.)

Interval Movie

Takes still pictures one by one at a set interval from a set time and records them as a single movie file. (Motion JPEG, file extension: .AVI)

Perform the following settings.

Interval	Set the shooting interval to 1 sec., 5 sec., 10 sec., 30 sec., 1 min., 5 min., 10 min., 30 min., or 1 hour.
Recording Time	Set the time at which to start and stop recording from 5 seconds to 99 hours. The time that can be set varies depending on [Interval].
Start Interval	Select whether to take the first picture now or at a set time. Selecting [Now] starts recording immediately. When [Set Time] is selected, set [Start Time].
Start Time	Set the time at which to start shooting.



This mode is available only when the mode dial is set to .

- 1 Select [Interval Movie] in the [Movie 1] menu, and press the four-way controller (▶).

The [Interval Movie] screen appears.

- 2 Use the four-way controller (▲ ▼) to select [Interval], and press the four-way controller (▶).

- 3 Use the four-way controller (▲ ▼) to select the shooting interval, and press the OK button.

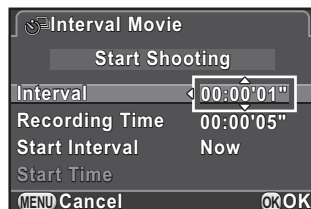

- 4 Use the four-way controller (▲ ▼) to select [Recording Time], and press the four-way controller (▶).

-
- 5** Use the four-way controller (◀▶) to select hours, minutes, or seconds, and use the four-way controller (▲▼) to set the time.

Press the **OK** button to complete the setting.

- 6** Use the four-way controller (▲▼) to select [Start Interval], and press the four-way controller (▶).
-

- 7** Use the four-way controller (▲▼) to select [Now] or [Set Time], and press the **OK** button.

If you selected [Now], proceed to Step 10.

- 8** Use the four-way controller (▲▼) to select [Start Time], and press the four-way controller (▶).
-

- 9** Use the four-way controller (◀▶) to select hours or minutes, and use the four-way controller (▲▼) to set the time.

Press the **OK** button to complete the setting.

- 10** Use the four-way controller (▲▼) to select [Start Shooting], and press the **OK** button.

The camera is ready to record an interval movie.

- 11** Press the shutter release button halfway.

The autofocus system operates.

- 12** Press the shutter release button fully.

When [Start Interval] is set to [Now], a picture is taken immediately, Instant Review is displayed, and then the monitor turns off.

When the specified number of pictures are taken, [Interval shooting complete] is displayed, and then the camera returns to normal movie recording mode.



- When recording with Interval Movie, use the AC adapter kit (optional) or install a fully charged battery. If the battery is not sufficiently charged, it may become depleted during recording and cause recording of the movie to stop.
- Interval Movie is canceled when the SD Memory Card has no more available space.

Playing Back Movies

Recorded movies can be played back in Playback mode in the same manner as saved still pictures.

1 Use the four-way controller (◀▶) to select a movie to play back.

The first frame of the movie is displayed on the monitor.

2 Press the four-way controller (▲).

Movie playback starts.

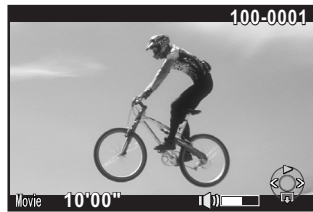

Available operations

Four-way controller (▲) Pauses/Resumes playback.

Four-way controller (▶) Forwards a frame (when paused).

Press and hold
four-way controller (▶) Fast-forwards playback.

Four-way controller (◀) Reverses a frame (when paused).

Press and hold
four-way controller (◀) Fast-reverses playback.

Four-way controller (▼) Stops playback./
Displays the playback mode palette
(when stopped). (p.146)

E-dial Adjusts the volume (6 levels).

 Av button Saves the displayed image as a JPEG file
(when paused) (p.112).

When the movie ends, playback stops and the first frame is displayed again.



- You can use the optional AV cable or a commercially available HDMI cable to play back recorded movies on a TV screen or other AV devices. (p.161)
- QuickTime is required to play back movies transferred to a computer. (p.200)

Capturing a Still Picture from a Movie

You can capture a single frame from a movie and save it as a JPEG still picture.

- 1 Press the four-way controller (▲) in Step 2 on p.111.
- 2 Use the four-way controller (◀▶) to display the frame to save as a still picture.

Frame number/
Total number of frames



- 3 Press the  Av button.
The save confirmation screen appears.
- 4 Use the four-way controller (▲▼) to select [Save as], and press the OK button.
The captured image is saved as a new image.

Editing Movies

Movies can be divided and unwanted segments can be deleted.

- 1 In Playback mode, use the four-way controller (◀▶) to select a movie to edit.
The first frame of the movie is displayed on the monitor.
- 2 Press the four-way controller (▼).
The playback mode palette appears.
- 3 Use the four-way controller (▲▼◀▶) to select  (Movie Editing), and press the OK button.
The movie editing screen appears.

4 Select point(s) where you want to divide the movie.

The frame at the dividing point is displayed at the top of the screen.

Up to four points can be selected to divide the original movie into five segments.

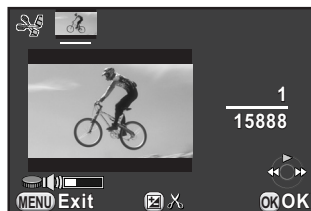

Available operations

Four-way controller (▲)	Plays back/Pauses a movie.
Four-way controller (▶)	Forwards a frame (when paused).
Press and hold four-way controller (▶)	Fast-forwards playback.
Four-way controller (◀)	Reverses a frame (when paused).
Press and hold four-way controller (◀)	Fast-reverses playback.
E-dial	Adjusts the volume (6 levels).
Av button	Confirms/cancels a dividing point.

Proceed to Step 8 if you do not delete any segment(s).

5 Press the **○/🗑️** button.

The screen to select segment(s) to delete is displayed.

6 Use the four-way controller (◀▶) to move the selection frame, and press the **OK** button.

The segment(s) to delete are specified. Multiple segments can be deleted at once.

Press the **OK** button again to cancel the selection.

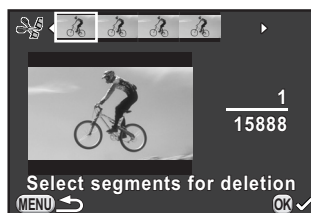

7 Press the **MENU** button.

The screen that was displayed in Step 4 appears again.

8 Press the **OK** button.

The save confirmation screen appears.

9 Use the four-way controller (▲▼) to select [Save as], and press the OK button.

The movie is divided at the specified points and the unwanted segments are deleted from it. Then, the divided movie is saved as separate files and displayed on the screen.

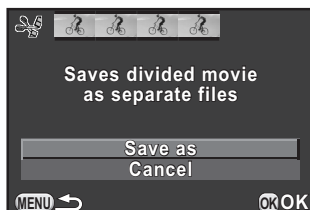

- Select dividing points in chronological order from the beginning of the movie. When canceling the selected dividing points, cancel each of them in reverse order (from the end of the movie to the beginning). In an order other than specified, you can neither select frames as a dividing point nor cancel the selections of the dividing points. You cannot, for example, select the frames prior to the last selected frame as a dividing point while selecting a dividing point.
- Movies with a short recording time cannot be divided.

5 Shooting Settings

This chapter describes image file formats and camera operating settings in capture mode.

Setting a File Format	116
Setting the White Balance	120
Adjusting Brightness	123
Setting the Image Finishing Tone	126
Setting the Green Button and E-dial Functions	138
Setting the Lens Functions	142

Setting a File Format

Set the aspect ratio, file format, number of recorded pixels, quality level, and color space of still pictures.

- 1 Select [Image Capture Settings] in the [📷 Rec. Mode 1] menu, and press the four-way controller (▶).

The [Image Capture Settings] screen appears.

- 2 Use the four-way controller (▲ ▼) to select [Aspect Ratio], [File Format], [JPEG Recorded Pixels], [JPEG Quality] or [Color Space], and press the four-way controller (▶).

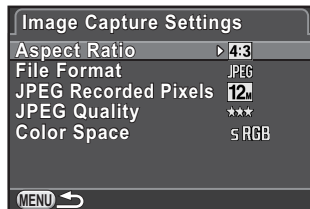

Refer to p.117 - p.119 for details about the settings.

- 3 Use the four-way controller (▲ ▼) to change the settings, and press the OK button.

- 4 Press the MENU button twice.

The screen that was displayed before selecting the menu appears again.



- The aspect ratio, file format, JPEG recorded pixels, and JPEG quality level can also be changed using the control panel.
- When the file format, JPEG recorded pixels, or JPEG quality level is changed, the number of images that can be recorded for that setting appears on the monitor.

Aspect Ratio

Select the horizontal and vertical ratio of images from $\frac{16}{9}$, $\frac{3}{2}$, $\frac{4}{3}$ (default setting) or $\frac{1}{1}$. The aspect ratio of the camera monitor is $\frac{3}{2}$, so if a different aspect ratio is selected, the monitor display changes to match the set aspect ratio.



The number of recordable images available with continuous shooting is reduced when the aspect ratio is set to $\frac{16}{9}$, $\frac{3}{2}$, or $\frac{1}{1}$ instead of $\frac{4}{3}$.

File Format

You can set the format of image files.

JPEG	Captures images in JPEG format. (default setting) You can change the number of recorded pixels in [JPEG Recorded Pixels], and the image quality level in [JPEG Quality].
RAW	The RAW format is a CMOS sensor output format saved without processing. RAW files are recorded with the general-purpose DNG (Digital Negative) format designed by Adobe Systems. Effects of White Balance, Custom Image and Color Space are not applied to the captured images, but they are saved as actual original information. When you perform the development process by using the RAW Development function (p.174), you can create JPEG images with these effects.
RAW+	Captures images in both RAW and JPEG formats. When [One Push File Format] is assigned to the button, you can press the button to temporarily change the file format and save an image in both file formats. (p.139)



- When Digital Filter, HDR Capture or Smart Effect is set, the file format is fixed to [JPEG] and cannot be changed. To change the file format, turn these functions off.
- When the capture mode is set to **BC** (Blur Control) mode or (Night Scene HDR)/ (Quick Macro)/**HDR** (HDR) of **SCN** (Scene) mode, the image is saved in JPEG format, regardless of the [File Format] setting.

JPEG Recorded Pixels

Sets the recording size of images when [File Format] is set to [JPEG]. The selectable sizes vary according to the [Aspect Ratio] setting.

Aspect Ratio	Recorded Pixels	Pixels
16:9	9M	4000×2248 (default setting)
	6M	3456×1944
	4M	2688×1512
	2M	1920×1080
3:2	10M	4000×2664 (default setting)
	8M	3456×2304
	5M	2688×1792
	2M	1920×1280
4:3	12M	4000×3000 (default setting)
	9M	3456×2592
	5M	2688×2016
	3M	1920×1440
1:1	9M	2992×2992 (default setting)
	6M	2592×2592
	4M	2016×2016
	2M	1440×1440



- The more pixels there are, the bigger the file size. The file size will also vary according to the [JPEG Quality] setting.
- The quality of a captured image depends on the exposure control, resolution of the printer and a variety of other factors.

JPEG Quality

You can set the image quality level (compression ratio). The default setting is ★★★ (Best).

★★★ Best	 Quality: clearer File size: larger
★★ Better	
★ Good	

Color Space

You can select a color space to use.

sRGB	Mainly used for devices such as a computer. (default setting)
AdobeRGB	Covers a wider range of color than sRGB and is used for commercial uses such as industrial printing.



The file naming system changes depending on the color space setting as shown below.







For sRGB: IMGpxxx.JPG

For AdobeRGB: _IGPxxx.JPG

“xxx” indicates the file number and is displayed as a four-digit sequential number.

Setting the White Balance

Adjusts the color of an image based on ambient light conditions so that white objects appear white.

Item	Setting	Color Temperature *1
AWB Auto	Automatically adjusts the white balance. (default setting)	Approx. 4,000 to 8,000K
 Daylight	For use when taking pictures in sunlight.	Approx. 5,200K
 Shade	For use when taking pictures in the shade. It reduces the bluish color tones in a picture.	Approx. 8,000K
 Cloudy	For use when taking pictures on cloudy days.	Approx. 6,000K
 Fluorescent Light	For use when taking pictures under fluorescent lighting. Select the type of fluorescent light. D Fluorescent - Daylight Color N Fluorescent - Daylight White W Fluorescent - Cool White L Fluorescent - Warm White	Approx. 6,500K Approx. 5,000K Approx. 4,200K Approx. 3,000K
 Tungsten	For use when taking pictures under light bulbs or other tungsten light. It reduces the reddish color tones in a picture.	Approx. 2,850K
 Flash	For use when taking pictures using the built-in flash.	Approx. 5,400K
CTE *2	Use this to keep and strengthen the color tone of the light source in the image.	—
 Manual	Use this to manually adjust the white balance according to the lighting when taking pictures.	—

*1 The color temperatures (K) shown above are all estimates. These do not indicate precise colors.

*2 CTE = Color Temperature Enhancement



The white balance is fixed to **AWB** when the capture mode is set to **AUTO** (Auto Picture) or **SCN** (Scene) mode.

1 Press the four-way controller (▼) in Capture mode.

The White Balance setting screen appears.

The last image taken after the camera was turned on is displayed in the background.

2 Use the four-way controller (◀▶) to select the white balance.

When  (Fluorescent Light) is selected, press the four-way controller (▼) and use the four-way controller (◀▶) to select **D**, **N**, **W**, or **L**.

Proceed to Step 6 if you do not need to change the parameters.





3 Press the Av button.

The fine-tuning screen appears.

4 Fine-tune the white balance.



Available operations

Four-way controller (▲▼)	Adjusts the tone of the colors between green (G) and magenta (M).
Four-way controller (◀▶)	Adjusts the tone of the colors between blue (B) and amber (A).
 /  button	Resets the adjustment value.

5 Press the OK button.

The screen that was displayed in Step 2 appears again.

6 Press the OK button.

The camera is ready to take a picture.



Because the light source changes when a flash discharges, you can set the white balance for when the flash discharges. Select [Auto White Balance], [Unchanged] or [Flash] in [5. WB When Using Flash] of the [C Custom Setting 1] menu.

Adjusting the White Balance Manually

You can adjust the white balance depending on the light source when taking pictures.

- 1 Select  in Step 2 on p.121.



- 2 Under the light you wish to measure the white balance of, fully display a white sheet of paper on the monitor, or select a white area as the subject.

- 3 Press the shutter release button fully.

Set [Focus Method] to **MF** when the shutter cannot be released.

Adjust the white balance as necessary.

The message [The operation could not be completed correctly] appears when measuring is unsuccessful. Press the **OK** button while displayed to remeasure the white balance.

- 4 Press the **OK** button.

The camera is ready to take a picture.



- No image is recorded when the shutter release button is pressed to adjust the white balance.
- If a picture is extremely overexposed or underexposed, the white balance may not be adjusted. In this case, adjust exposure to the correct exposure before adjusting the white balance.

Adjusts the brightness and reduces the occurrence of overexposed and underexposed areas.

Highlight Correction

Expands the dynamic range and enables a wider range of tones by the CMOS sensor and reduces the occurrence of overexposed areas.

1 Press the **INFO** button in Capture mode.

The control panel appears.

2 Use the four-way controller (▲▼◀▶) to select **[Highlight Correction]**, and press the **OK** button.

The [Highlight Correction] screen appears.

3 Use the four-way controller (◀▶) to select **[Auto]**, **[On]** or **[Off]**, and press the **OK** button.

The camera returns to the control panel.

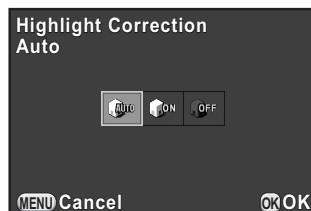

- When [Highlight Correction] is set to [On], the minimum sensitivity is set to ISO 200.
- The selectable items are limited in the following capture modes:
 - (Night Snap) or (Stage Lighting) of **SCN** (Scene) mode
 - **M** (Manual Exposure) mode

Fixed to [On]
[Auto] not available

Shadow Correction

Expands the dynamic range and enables a wider range of tones by the CMOS sensor and reduces the occurrence of underexposed areas.

- 1 Press the **INFO** button in Capture mode.

The control panel appears.

- 2 Use the four-way controller (▲▼◀▶) to select [Shadow Correction], and press the **OK** button.

The [Shadow Correction] screen appears.

- 3 Use the four-way controller (◀▶) to select [Auto], [On] or [Off], and press the **OK** button.

The camera returns to the control panel.

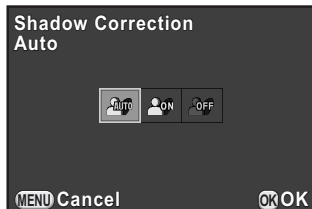

You can also set Highlight Correction and Shadow Correction in [D-Range Setting] of the [Rec. Mode 2] menu.

HDR Capture

Enables capturing images with high dynamic range. Takes three images (-3 EV underexposed, standard (proper exposure) and +3 EV overexposed) to create a single composite image with them.



- HDR Capture is not available in the following situations.
 - When [File Format] is set to [RAW] or [RAW+]
 - When the shutter speed is set to **Bulb**
 - When the capture mode is set to **BC** (Blur Control), (Movie) mode, or (Quick Macro) of **SCN** (Scene) mode
- When HDR Capture is set, the following functions are not available.
 - Flash discharge
 - Continuous Shooting, Remote Continuous Shooting, or Exposure Bracketing
 - Multi-exposure or Digital Filter
- During HDR Capture, shutter speeds of 1/8 sec. or slower are not available.
- During HDR Capture, multiple images are combined together to create a single image, so it will take time to save the composite image.
- Make sure to hold the camera firmly so that it does not move while the three images are taken. If there is a great difference between the three images due to camera movement, the message [The operation could not be completed correctly] appears, and the composite image will not be saved.

1 Press the **INFO** button in Capture mode.

The control panel appears.

2 Use the four-way controller (▲▼◀▶) to select [HDR Capture], and press the **OK** button.

The [HDR Capture] screen appears.

3 Use the four-way controller (◀▶) to select [Off], [Auto], [HDR 1] or [HDR 2], and press the **OK** button.

The camera returns to the control panel.

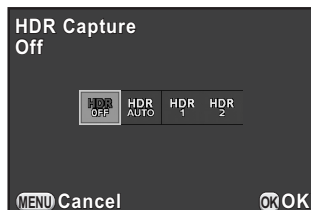

- [HDR Capture] is fixed to [Auto] when the capture mode is set to (Night Scene HDR) or **HDR** (HDR) of **SCN** (Scene) mode.
- You can also change the setting from the [Rec. Mode 2] menu.

Take pictures with settings to suit for your creative photographic vision.

Setting Custom Image

Select the desired picture style from the following modes and enjoy taking pictures with a creative finishing tone.

Image Tone	Image
Bright	Saturation, hue, and contrast will be rather high to create a bright sharp image. (default setting)
Natural	Creates a natural look that is close to the actual color.
Portrait	Reproduces a healthy and bright skin tone.
Landscape	Increases color saturation, highlights shapes, and produces a vivid color image
Vibrant	Changes the color slightly to create an antique look.
Radiant	Emphasizes glossiness to produce a spectacular finish.
Muted	Reduces the saturation to create a soft look.
Bleach Bypass	Reduces the saturation and increases the contrast to create the look of an old picture.
Reversal Film	Creates a picture with strong image contrast as if taken with reversal film.
Monochrome	Takes pictures using a B&W color filter.
Cross Processing	Intentionally changes the hue and contrast. The outcome varies each time a picture is taken.



Custom Image is not available when the capture mode is set to **AUTO** (Auto Picture) or **SCN** (Scene) mode.

1 Press the **INFO** button in Capture mode.

The control panel appears.

- 2** Use the four way controller (▲▼◀▶) to select [Custom Image], and press the OK button.

The Custom Image setting screen appears.

The last image taken after the camera was turned on is displayed in the background.

- 3** Use the four-way controller (▲▼◀▶) to select an image finishing tone.

You can check the selected Custom Image effect with the background image.

Proceed to Step 8 if you do not need to change the parameters.

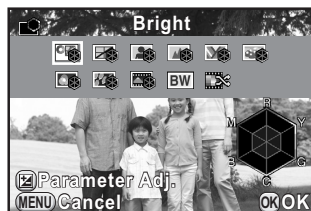

- 4** Press the  Av button.

The screen to select a parameter appears.

- 5** Use the four-way controller (▲▼) to choose a parameter you want to change.



The following parameters can be changed according to the selected image finishing tone.

Image Tone	Parameter
Bright/Natural/Portrait/ Landscape/Vibrant/Radiant	Saturation: -4 to +4
	Hue: -4 to +4
	High/Low Key Adj: -4 to +4
	Contrast: -4 to +4
	Sharpness/Fine Sharpness: -4 to +4



Image Tone	Parameter
Muted/Bleach Bypass	Saturation: -4 to +4
	Toning: Off/Green/Yellow/Orange/Red/Magenta/Purple/Blue/Cyan
	High/Low Key Adj: -4 to +4
	Contrast: -4 to +4
	Sharpness/Fine Sharpness: -4 to +4
Reversal Film	Sharpness/Fine Sharpness: -4 to +4
Monochrome	Filter Effect: None/Green/Yellow/Orange/Red/Magenta/Blue/Cyan/Infrared Filter
	Toning: Off/Green/Yellow/Orange/Red/Magenta/Purple/Blue/Cyan
	High/Low Key Adj: -4 to +4
	Contrast: -4 to +4
	Sharpness/Fine Sharpness: -4 to +4
Cross Processing	Random/Preset 1-3/Favorite 1-3 *1

*1 For [Favorite 1-3], you are required to save the settings of a cross processed image as a favorite in advance through the playback mode palette. (p.129)

6 Use the four-way controller (◀▶) to change the settings.

You can check the saturation and hue with the radar chart.

Available operations

E-dial	Switches between [Sharpness] and [Fine Sharpness]. (Not available in  mode.)
 /  button	Resets the set value.

7 Press the OK button.

The screen that was displayed in Step 3 appears again.

8 Press the OK button.

The camera returns to the control panel.



You can also change the settings from the [ Rec. Mode 1] menu.

Saving the Cross Processing Settings of a Captured Image

The outcome of cross processing varies each time a picture is taken. If you take a cross processed image that you like, you can save the Cross Processing settings used in that image. A total of three Cross Processing settings can be saved.

1 Press the four-way controller (▼) in Playback mode.

The playback mode palette appears.

2 Use the four-way controller (▲▼◀▶) to select (Save Cross Processing), and press the OK button.

The camera will search for cross processed images starting from the most recent image taken. (An hourglass icon is displayed while searching.) When a cross processed image is found, the screen to save the settings appears.

If there are no cross processed images, the message [No cross processed image] appears.

3 Use the e-dial to select a cross processed image.



4 Use the four-way controller (▲▼) to select a number, and press the OK button.

The settings of the selected image are saved to [Favorite 1 - 3] and the last displayed image is displayed again.

Setting the Digital Filter

You can apply a filter effect when taking pictures. The following filters can be selected.

Filter Name	Effect	Parameter
Toy Camera	For taking pictures that look as if taken with a toy camera.	Shading Level: Low/Medium/High
		Blur: Low/Medium/High
		Tone Break: Red/Green/Blue/Yellow
High Contrast	For taking pictures with high contrasts.	Intensity: 1 to 5
Shading	For taking pictures with the background darkened.	Shading Type: 6 types
		Shading Level: -3 to +3
Slim	Changes the horizontal and vertical ratio of images.	-8 to +8
HDR	Creates an image that looks like a high dynamic range image.	Low/Medium/High
Invert Color	Inverts the colors in the image.	OFF/ON
Extract Color	For extracting two specific colors and making the rest of the image black and white.	Extracted Color 1: Red/Magenta/Blue/Cyan/Green/Yellow
		Extractable Range of Color 1: 1 to 5
		Extracted Color 2: OFF/Red/Magenta/Blue/Cyan/Green/Yellow
		Extractable Range of Color 2: 1 to 5
Color	For taking pictures with the selected color filter.	Color: Red/Magenta/Blue/Cyan/Green/Yellow
		Color Density: Light/Medium/Dark
Water Color	For taking a picture that looks as though it was painted.	Intensity: Low/Medium/High
		Saturation: OFF/Low/Medium/High
Posterization	Lessens the tone of the image to create an image that looks as though it was hand-drawn.	Intensity: 1 to 5
Fish-eye	For taking pictures that look as if taken with a fish-eye lens.	Low/Medium/High



- Digital Filter is not available in the following situations.
 - when the capture mode is set to (Night Scene HDR)/**HDR** (HDR) of **SCN** (Scene) mode
 - when [File Format] is set to [RAW] or [RAW+]
- When Digital Filter is set, Multi-exposure and HDR Capture are not available.
- Depending on the filter used, it may take longer to save images.

1 Press the **INFO** button in Capture mode.

The control panel appears.

2 Use the four-way controller (▲▼◀▶) to select [Digital Filter], and press the **OK** button.

The screen to select a filter appears.

The last image taken after the camera was turned on is displayed in the background.

3 Use the four-way controller (▲▼◀▶) to select a filter.

You can check the selected filter effect with the background image.

Proceed to Step 7 if you do not need to change the parameters.

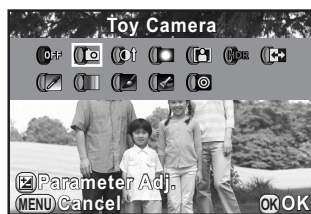

4 Press the **Av** button.

The parameter setting screen appears.

5 Use the four-way controller (▲▼) to select a parameter, and the four-way controller (◀▶) to adjust the parameter's value.



6 Press the **OK** button.

The screen that was displayed in Step 3 appears again.

7 Press the OK button.

The camera returns to the control panel.



- You can also change the settings from the [📷 Rec. Mode 1] menu.
- Select [Not use any filters] in Step 3 to finish shooting with a digital filter.
- JPEG and RAW images can be processed with digital filters in Playback mode. (p.168)

Saving Frequently Used Functions to the Quick Dial

You can save frequently used functions to the quick dial to easily load and use the desired settings when taking pictures.

Save up to four settings to each of the following functions.

- Smart Effect (p.134)
- Digital Filter (p.130)
- Custom Image (p.126)
- Aspect Ratio (p.117)



You can save only one of the above functions. You cannot assign multiple functions at the same time.

1 Select [Quick Dial] in the [📷 Rec. Mode 3] menu, and press the four-way controller (▶).

The screen for setting the quick dial function appears.

2 Use the four-way controller (◀▶) to select the function to save.

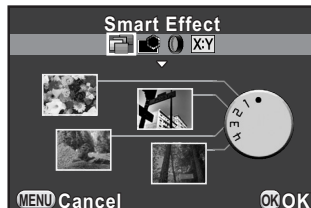

3 Use the four-way controller (▲▼) to select the position 1-4 of the quick dial to which to save the setting.

4 Use the four-way controller (◀ ▶) to select the desired setting.

To make detailed settings for Smart Effect, press the  **Av** button.

5 Repeat Steps 3 and 4.

Save the settings to the other positions in the same way.

6 Press the **OK** button.

The setting assigned to each position is saved.

7 Press the **MENU** button.

The screen that was displayed before selecting the menu appears again.

Loading Settings for Taking Pictures

You can take pictures with the settings saved in the quick dial, and while using the quick dial, these settings have priority over the settings such as ones made through the menus.

1 In Capture mode, turn the quick dial to select the position 1 to 4.

The setting saved in the selected position is loaded, and the camera is ready to take a picture.

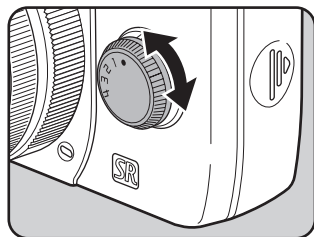

2 Take a picture.

3 After taking pictures, return the quick dial to the position 0.

The camera returns to the original setting.



You cannot use the menus to change the settings when taking pictures with the quick dial. To change the settings of the quick dial, save other settings again.

Setting the Smart Effect

You can set and capture images with a variety of effects. Select from the following types of effects.

- Brilliant Color
- Unicolor Bold
- Vintage Color
- Cross Processing
- Warm Fade
- Tone Expansion
- Bold Monochrome
- Water Color
- Vibrant Color Enhance
- USER 1 to 3 (p.136)

1 Select [Smart Effect] in Step 2 on p.132.

2 Use the four-way controller (▲▼) to select the position 1-4 of the quick dial to which to save the desired effect.

3 Press the  Av button.

The screen for making detailed Smart Effect setting screen appears.

4 Use the four-way controller (▲▼◀▶) to choose an effect.

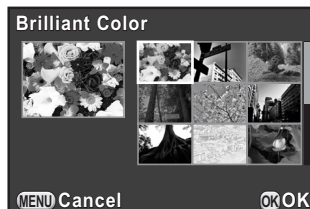

5 Press the OK button.

The camera returns to the screen for setting the quick dial function.

6 Repeat Steps 2 to 5.

7 Press the OK button.

The selected effects are saved to the position 1-4 of the quick dial.

8 Press the MENU button.

The screen that was displayed before selecting the menu appears again.

Shooting with Smart Effect



- The file format is fixed to [JPEG].
- Multi-exposure, HDR Capture, Custom Image and Digital Filter are not available.

1 Turn the quick dial to select the position 1 to 4.

The effect saved in the selected position is loaded, and the camera is ready to take a picture.

2 Press the four-way controller (▼) to change the parameters.

The parameter setting screen appears.

3 Use the four-way controller (◀▶) to change the parameters.

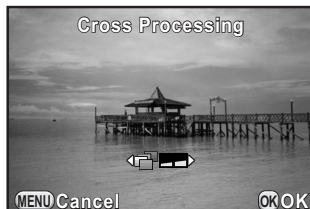

The following parameters can be changed depending on the selected effect.

Effect	Parameter
Brilliant Color/Cross Processing/ Warm Fade/Tone Expansion/Bold Monochrome/Water Color/Vibrant Color Enhance	Intensity: 2 levels
Unicolor Bold	Extracted Color: Red/Magenta/Blue/ Cyan/Green/Yellow
Vintage Color	Type: 3 types

4 Press the OK button.

The camera is ready to take a picture.

Saving the Camera Settings

You can save the current camera settings and retrieve them later on by the quick dial operation.

- 1 Set necessary settings.
- 2 Select from USER 1 to 3 in Step 4 on p.134.

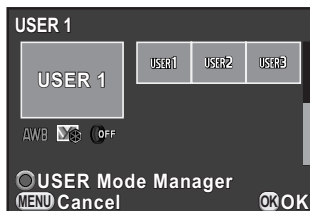

- 3 Press the button.
The save confirmation screen appears.

- 4 Use the four-way controller () to select [Save Settings], and press the **OK** button.

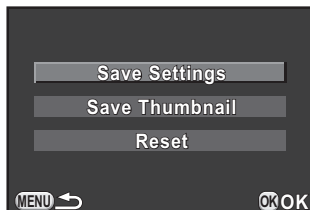

- 5 Use the four-way controller () to select [Save], and press the **OK** button.

The settings are saved, and the screen that was displayed in Step 2 appears again.

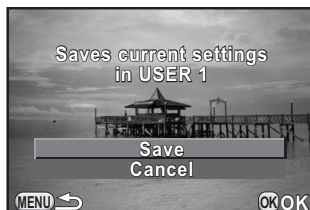



Saving a Thumbnail Image to the USER Mode

If you take an image that you like, you can save the image along with the settings used in that image to make it even easier to replicate the look of the image.

1 Select from USER 1 to 3 to which settings were saved on the screen in Step 2 on p.136.

2 Press the /  button.

The save confirmation screen appears.



3 Use the four-way controller ( ) to select [Save Thumbnail], and press the **OK** button.

The image selection screen appears.

4 Turn the e-dial to choose an image.

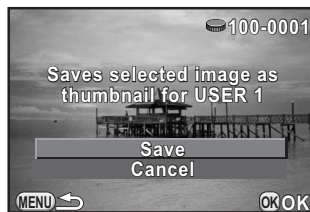
You can select from any of the captured images.







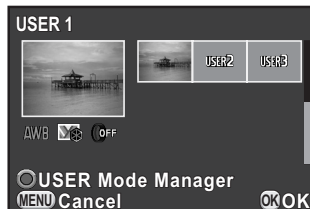





5 Use the four-way controller ( ) to select [Save], and press the **OK** button.

The image is saved and displayed in the image list.





Setting the Green Button Operation



You can assign one of the following functions to the / button and access the function by simply pressing the button when shooting.

Green Button	Resets the values being adjusted. (default setting)
Preview	While the  /  button is pressed, you can check the depth of field by stopping down the aperture to the set value. (p.92)
One Push File Format	Temporarily changes the file format. Simultaneously saves an image in both JPEG and RAW formats, regardless of the [File Format] setting. You can set whether to apply the setting to only one image or not, and select the file format when the  /  button is pressed. (p.139)
AE Lock	The exposure setting is locked when the  /  button is pressed. (p.80)
Enable AF	Autofocus is performed only when the  /  button is pressed and not when the shutter release button is pressed halfway. (p.88)

5

- 1 Select [Green Button] in the [ Rec. Mode 3] menu, and press the four-way controller ().

The [Green Button] screen appears.

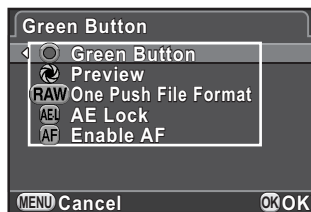

- 2 Press the four-way controller () , use the four-way controller ( ) to select a function, and press the OK button.









- 3 Press the MENU button twice.

The screen that was displayed before selecting the menu appears again.



Setting the One Push File Format





When [One Push File Format] is assigned to the / button, specify the function settings.

- 1 Select [One Push File Format] in Step 2 on p.138.
- 2 Use the four-way controller ( ) to select [Cancel after 1 shot], and use the four-way controller ( ) to select or .

<input checked="" type="checkbox"/>	The recording format returns to the original file format after a picture is taken. (default setting)
<input type="checkbox"/>	The setting is canceled when any of the following operations are performed. <ul style="list-style-type: none"> - the / button is pressed again - the  button, MENU button, INFO button or power switch is pressed - the mode dial is turned

- 3 Use the four-way controller ( ) to choose a file format.

The left side is the [File Format] (p.117) setting and the right side is the file format when the / button is pressed.

- 4 Press the four-way controller () , use the four-way controller ( ) to select a file format that is used when the / button is pressed, and press the **OK** button.

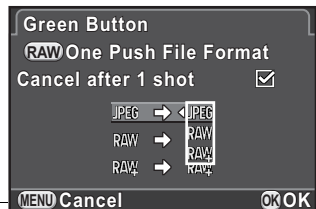

- 5 Press the **MENU** button twice.

The screen that was displayed before selecting the menu appears again.

Setting the E-dial Operation in P Mode

Set the value to be changed with the e-dial when the capture mode is set to **P** (Program Automatic Exposure) mode.

- 1 Select [Green Button] in Step 2 on p.138.
- 2 Use the four-way controller (▲▼) to select [E-dial in Program], and press the four-way controller (▶).
- 3 Use the four-way controller (▲▼) to select the value to be changed with the e-dial, and press the OK button.

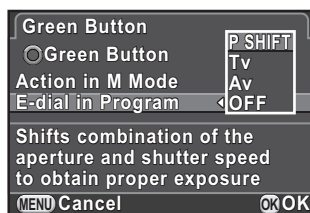

P SHIFT	Automatically adjusts the shutter speed and aperture value to obtain a proper exposure (Program shift). (default setting)
Tv	Switches to Shutter Priority Automatic Exposure mode. Turn the e-dial to adjust the shutter speed.
Av	Switches to Aperture Priority Automatic Exposure mode. Turn the e-dial to adjust the aperture value.
OFF	Disables the e-dial operation when turned in P mode.



- 4 Press the **MENU** button twice.







The screen that was displayed before selecting the menu appears again.





If the  button is pressed after turning the e-dial in **P** mode, the settings return to normal **P** mode.

Setting the Green Button Operation in M Mode

You can set the function of the / button when the capture mode is set to **M** (Manual Exposure) mode.

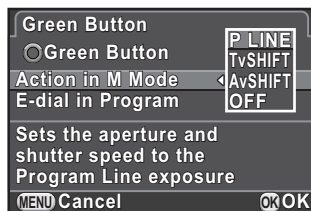
- 1 Select [Green Button] in Step 2 on p.138.
- 2 Use the four-way controller ( ) to select [Action in M Mode], and press the four-way controller ().
- 3 Use the four-way controller ( ) to select a function to assign to the / button, and press the **OK** button.



P LINE	Adjusts the aperture value and shutter speed to obtain a proper exposure according to the Program Line. (default setting)
Tv SHIFT	Adjusts the shutter speed while the aperture value remains fixed to obtain a proper exposure.
Av SHIFT	Adjusts the aperture value while the shutter speed remains fixed to obtain a proper exposure.
OFF	Disables the  /  button operation when pressed in M mode.

- 4 Press the **MENU** button twice.

The screen that was displayed before selecting the menu appears again.

You can set the lens functions. Depending on the type of the lens attached, available functions differ.

Setting the ND Filter

Sets whether to use the ND filter built-in to the lens.

1 Press the **INFO** button in Capture mode.

The control panel appears.

2 Use the four-way controller (▲▼◀▶) to select [ND Filter], and press the **OK** button.

The [ND Filter] screen appears.

3 Use the four-way controller (◀▶) to select [Off] or [On], and press the **OK** button.

The camera returns to the control panel.

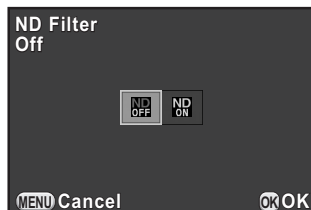

- You can also change the setting from the [📷 Rec. Mode 1] menu.
- This function is fixed to [Off] when an ND filter is not built in to the lens.

Correcting Lens Distortion

Reduces lens distortions occurring due to lens properties.

1 Select [Distortion Correction] in the [📷 Rec. Mode 2] menu, and press the four-way controller (▶).

2 Use the four-way controller (▲▼) to select [On] or [Off], and press the OK button.

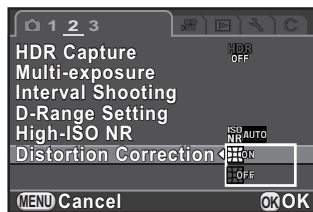

3 Press the MENU button.

The screen that was displayed before selecting the menu appears again.



The effects of the Distortion Correction function may be barely noticeable in some cases depending on the shooting conditions and other factors.

Memo

6 Playback Functions

This chapter describes how to use the various playback functions.

Playback Functions Operation	146
Setting the Playback Display Method	148
Enlarging Images	149
Displaying Multiple Images	150
Displaying Rotated Images	157
Deleting Multiple Images	158
Connecting the Camera to an AV Device	161

Make settings related to playing back images in the playback mode palette or [▶ Playback] menu.



For details on how to use the menus, refer to “Using the Menus” (p.32).

Playback Mode Palette Items



Press the four-way controller (▼) in Playback mode to display the playback mode palette.

You can also display the playback mode palette when a movie is paused.



6

Item	Function	Page
Image Rotation *1	Displays the rotated image.	p.157
Digital Filter *1	Applies filter effects to images for creative control of the picture.	p.168
Red-eye Edit *1 *2	Corrects images of a subject captured with red eyes.	p.173
Resize *1 *2	Changes the number of recorded pixels or size of the image, and saves the image as a new file.	p.166
Cropping *1	Crops out only the desired area of the picture and saves it as a new image.	p.167
Index	Joins a number of images together and creates a new image with them.	p.153
Protect	Protects images from being accidentally erased.	p.194
Slideshow	Plays back the images one after another.	p.156
Save Cross Processing *1	Saves the settings for an image captured in Cross Processing mode of Custom Image as Favorite.	p.129
RAW Development *3	Converts RAW images to JPEG format.	p.174

Item	Function	Page
 Movie Editing *4	Divides a movie and deletes unwanted segments.	p.112
 DPOF *1 *2	Sets the number of prints and whether to print the date on images saved on the SD Memory Card.	p.196



*1 This cannot be performed when a movie is displayed.

*2 This cannot be performed when a RAW image is displayed.

*3 This can be performed only when a RAW images are saved.

*4 This can be performed only when a movie is displayed.

Playback Menu Items

You can perform the following settings in the [ Playback] menu. Press the **MENU** button in Playback mode to display the [ Playback 1] menu.

Menu	Item	Function	Page
 1	Slideshow	Plays back the images one after another. You can set how images will be displayed in the slideshow.	p.155
	Quick Zoom	Sets the initial magnification when enlarging images.	p.148
	Bright/Dark Area	Sets whether or not to display the Bright/Dark Area warning during playback.	
	Delete All Images	You can delete all saved images at once.	p.160

Setting the Playback Display Method

You can set the initial magnification when enlarging images, and whether to display the Bright/Dark Area warning in Playback mode.

1 Select [Quick Zoom] in the [▶ Playback 1] menu, and press the four-way controller (▶).

2 Use the four-way controller (▲▼) to select the magnification, and press the OK button.

Select from [Off] (default setting), [x2], [x4], [x8] or [x16].

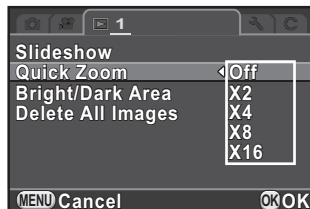

3 Use the four-way controller (▲▼) to select [Bright/Dark Area], and use the four-way controller (◀▶) to select or .

When set to , bright portions blink red and dark portions blink yellow.

4 Press the MENU button.

The screen that was displayed before selecting the menu appears again.



The Bright/Dark Area warning is not displayed in RGB histogram display and Detailed information display.

Images can be enlarged up to 16 times in Playback mode.

1 Use the four-way controller (◀▶) to select an image in Playback mode.

2 Turn the e-dial to the right (toward Q).

The image enlarges at each click (1.2 to 16 times).



Available operations

E-dial to the right (Q)	Enlarges the image (up to 16 times).
E-dial to the left (Q)	Reduces the image (up to 1 times).
Four-way controller (▲▼◀▶)	Changes the area to display.
OK button	Returns a position of the enlarged area to the center (when the enlarged area has been moved to the side).
INFO button	Switches information display On/Off.



- The default setting for the first click (minimum magnification) is 1.2 times. You can change this in [Quick Zoom] of the [▶ Playback 1] menu. (p.148)
- The initial full display of vertical images is displayed with a magnification of 0.675 times that of horizontal images, therefore, magnification at the first click starts at 1.0 times.

Multi-image Display Screen

You can display 4, 9, 20, 42 or 90 thumbnail images on the monitor at the same time. The default setting is nine-image display.

1 Turn the e-dial to the left (toward) in Playback mode.

The multi-image display screen appears.

Up to nine thumbnail images will be displayed at once (default setting).

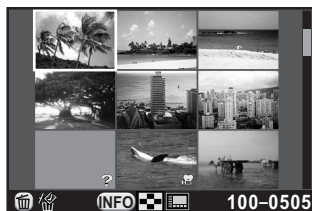

Available operations

Four-way controller (▲▼◀▶) Moves the selection frame.

INFO button Displays the [Multi-imp Display Setting] screen.





(Display Type cannot be selected when developing multiple RAW images (p.176).)

 button Selects and deletes multiple images. (p.158)

2 Press the OK button.

A full screen display of the selected image appears.



Icons such as  and  are not displayed with thumbnail images for 90-image display.

Displaying Images by Folder

Images will be grouped and displayed by the folder in which they are saved.

- 1 In the multi-image display screen, turn the e-dial to the left (toward ) again.

The folder display screen appears.

The number of images saved in the selected folder appears at the top right of the screen.



Available operations

Four-way controller (▲▼◀▶)	Moves the selection frame.
⊙/🗑 button	Deletes the selected folder. (p.159)

- 2 Press the OK button.

The multi-image display screen for the selected folder appears.

Displaying Images by Shooting Date (Calendar Display)

Images will be grouped and displayed by the shooting date.

1 In the multi-image display screen, press the **INFO** button.

The [Multi-Img Display Setting] screen appears.

2 Press the **INFO** button again.

The calendar display screen appears.

Only the dates when pictures were taken are displayed.

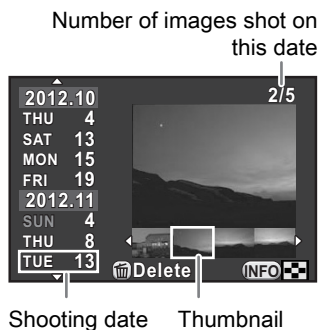

Available operations

Four-way controller (▲▼)	Selects a shooting date.
Four-way controller (◀▶)	Selects an image taken on the selected shooting date.
E-dial to the right (Q)	Displays the selected image at full screen. Turn to the left (⊞) to return to the calendar display.
INFO button	Returns to the multi-image display screen.
⊞/🗑 button	Deletes selected images.

3 Press the **OK** button.

A full screen display of the selected image appears.

Joining Multiple Images (Index)

Join a number of images together and display them as an index print. You can have the camera select the images to include or you can select the images to include in the index print, and the images will be randomly arranged or displayed by file number depending on the layout selected.







1 Press the four-way controller (▼) in Playback mode.

The playback mode palette appears.

2 Use the four-way controller (▲▼◀▶) to select  (Index), and press the OK button.

The Index setting screen appears.

3 Press the four-way controller (▶), use the four-way controller (▲▼) to select a layout, and press the OK button.

You can select  (Thumbnail),  (Square),  (Random1),  (Random2),  (Random3) or  (Bubble).

Images are displayed according to the file number (from the smallest number) for , and are displayed in random order for other layouts.

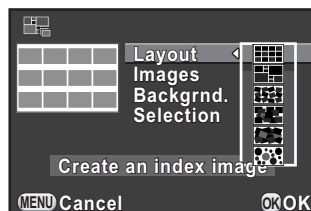

4 Use the four-way controller (▲▼) to select [Images], and press the four-way controller (▶).

5 Use the four-way controller (▲▼) to select the number of images, and press the OK button.

You can select 12, 24 or 36 images.

When the number of saved images is smaller than the number selected, empty spaces will appear when [Layout] is set to  and some images may be duplicated for other layouts.



6 Use the four-way controller (▲▼) to select [Backgrnd.], and press the four-way controller (▶).

- 7** Use the four-way controller (▲▼) to select the background color, and press the **OK** button.

You can select a white or black background.

- 8** Use the four-way controller (▲▼) to select [Selection], and press the four-way controller (▶).



- 9** Use the four-way controller (▲▼) to select a type of image selection, and press the **OK** button.

 Auto	Picks images automatically from all of the images saved.
 Manual	Individually select images you want to include in the index. Continue by selecting [Select image(s)] and select the individual images.
 Folder name	Picks images automatically from the folder selected. Continue by selecting [Select a folder] and select the folder.

- 10** Use the four-way controller (▲▼) to select [Create an index image], and press the **OK** button.

The index image is created and a confirmation screen appears.

- 11** Use the four-way controller (▲▼) to select [Save] or [Reshuffle], and press the **OK** button.

Save	The index image is saved as a  and ★★★ file.
Reshuffle	Reselects the images to be included in the index and displays a new index image. However, if  (Thumbnail) is selected for [Layout], this item is not displayed.

After the index image is saved, the camera returns to Playback mode and the index image is displayed.



Processing may take a while when creating an index image.

Playing Back Images Continuously

You can play back all images saved on your SD Memory Card successively in the slideshow.

Setting the Slideshow Display

Sets how images will be displayed during Slideshow.

- 1 Select [Slideshow] in the [▶] Playback 1] menu, and press the four-way controller (▶).

The Slideshow setting screen appears.

- 2 Use the four-way controller (▲▼) to select an item you want to change.

The following items can be changed.



Item	Description	Setting
Interval	Select an image display interval.	3sec. (default setting)/ 5sec./10sec./30sec.
Screen Effect	Select a transition effect when the next image is displayed.	Off (default setting)/Fade/ Wipe/Shrink
Repeat Playback	Set whether to start the slideshow again from the beginning after the last image is displayed.	<input type="checkbox"/> (default setting)/ <input checked="" type="checkbox"/>

- 3 Press the four-way controller (▶), use the four-way controller (▲▼) to change the setting, and press the OK button.

Starting the Slideshow

- 1 Select [Start] in Step 2 on p.155, and press the **OK** button.
Or, select  (Slideshow) in the playback mode palette, and press the **OK** button.

The start screen is displayed and the slideshow begins.



Available operations

OK button	Pauses/resumes playback.
Four-way controller (◀)	Displays the previous image.
Four-way controller (▶)	Displays the next image.

- 2 Press the four-way controller (▼).

Slideshow stops and the single image display reappears.

After slideshow ends, the camera returns to the single image display even if you do not press the four-way controller (▼).



For movies, only the first frame is displayed and then the next image is displayed after the set interval has elapsed. To play back a movie during a slideshow, press the **OK** button while the first frame is displayed. When the movie playback is finished, the slideshow will resume.

You can change the rotation information of an image and save it. Images with changed image rotation information are displayed at the changed orientation during playback.



- You cannot change the rotation information of the following images.
 - Protected images
 - Images without a rotation information tag
- Movie files cannot be rotated.

1 Select the image you want to rotate in Playback mode, and press the four-way controller (▼).

The playback mode palette appears.

2 Use the four-way controller (▲▼◀▶) to select ◊ (Image Rotation), and press the OK button.

The selected image is rotated in 90° increments and the four thumbnail images are displayed.

3 Use the four-way controller (▲▼◀▶) to select the desired rotation direction, and press the OK button.

The image rotation information is saved.

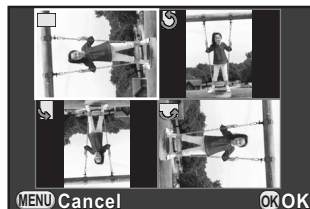

You can delete multiple images at once. Be aware that deleted images cannot be restored.

- ☞ Protecting Images from Deletion (Protect) (p.194)

Deleting Selected Images

You can delete multiple images in the multi-image display at once.



- Protected images cannot be selected.
- You can select up to 100 images at a time.

1 Turn the e-dial to the left (toward ) in Playback mode.

The multi-image display screen appears.

2 Press the /  button.

The screen to select images to delete is displayed.

The screen temporarily changes to 42-image display when [Multi-Img Display Setting] (p.150) is set to 90-image display.

3 Select the images to delete.



Available operations

Four-way controller Moves the selection frame.
(▲▼◀▶)

OK button Confirms/cancels the selection of the image to delete.

E-dial Displays a full screen display of the selected image.
(Use the four-way controller (◀▶) to display the previous or next image.)

4 Press the / button.

The delete confirmation screen appears.

5 Press the four-way controller () to select [Select & Delete], and press the **OK** button.







The selected images are deleted.

Deleting a Folder

You can delete a selected folder and all the images in it.

1 Turn the e-dial two clicks to the left (toward ) in Playback mode.



The folder display screen appears.

2 Use the four-way controller (   ) to select a folder to delete, and press the / button.

The folder delete confirmation screen appears.

3 Press the four-way controller () to select [Delete], and press the **OK** button.

The selected folder and all images in it are deleted.

The confirmation screen appears when there are protected images. Use the four-way controller ( ) to select [Delete All] or [Leave All] and press the **OK** button.

When [Delete All] is selected, protected images are also deleted.

Deleting All Images

You can delete all saved images at once.

- 1** Select [Delete All Images] in the [ Playback 1] menu, and press the four-way controller (▶).

The confirmation screen for deleting all images is displayed.

- 2** Press the four-way controller (▲) to select [Delete All Images], and press the **OK** button.

All images are deleted.

The confirmation screen appears when there are protected images. Use the four-way controller (▲▼) to select [Delete All] or [Leave All] and press the **OK** button.

When [Delete All] is selected, protected images are also deleted.

You can connect the camera to a TV or other device with a video input terminal or HDMI input terminal and play back images.



- For an AV device with multiple video input terminals, check the operating manual of the AV device, and select a suitable video input terminal for connecting the camera.
- You cannot output both composite and HDMI video signals at the same time.
- While the camera is connected to an AV device, nothing is displayed on the camera monitor. Also, you cannot adjust the volume on the camera. Adjust the volume on the AV device.
- If you intend to use the camera continuously for a long period, use of the AC adapter kit (optional) is recommended. (p.40)

Connecting the Camera to a Video Input Terminal or HDMI Input Terminal

Have a cable according to the terminal of the device to which you connect.

Terminal of AV Device	Cable Used
Video terminal	AV cable I-AVC7 (optional)
HDMI terminal	HDMI cable with an HDMI terminal (Type D) (sold separately)

1 Turn the AV device and camera off.

2 Open the terminal cover of the camera, and connect the cable to either the PC/AV terminal or HDMI terminal.

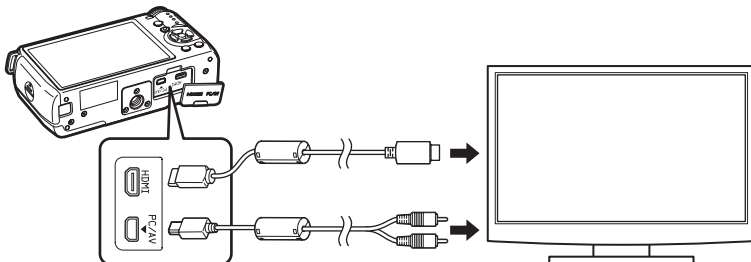

3 Connect the other end of the cable to the video input terminal on the AV device.

4 Turn the AV device and camera on.

The camera turns on in video mode or HDMI mode, and the camera information is displayed on the screen of the connected AV device.



When using the video output, images are output at normal resolution regardless of the resolution supported by the AV device. To output HD video, use the HDMI output or transfer to and play back on a computer.

Setting the Video/HDMI Output Format

Set the video/HDMI output format according to the connected terminal. Normally, the default output format setting does not have to be changed. However, if it fails to play back images properly, change the output format setting.



To change the setting, remove the cable first before proceeding.

Selecting the Video Output Format

When the hometown is set at the time of initial setting (p.47), the video output format is also set in accordance with that region. Depending on the country or region, images may fail to be played back with the set video output format. If this happens, change the video output format setting.

1 Select [Video Out] in the [Set-up 2] menu, and press the four-way controller (▶).

2 Use the four-way controller (▲ ▼) to select [NTSC] or [PAL], and press the **OK** button.

3 Press the **MENU** button.

The screen that was displayed before selecting the menu appears again.



The video output format differs depending on the region. When you set [Setting the Time] in the World Time setting (p.181) to (Destination), the video output setting changes to the video output format for that city. Refer to “List of World Time Cities” (p.183) for cities that can be selected as a hometown or destination.

Selecting the HDMI Output Format

By default, the maximum resolution is automatically selected to suit the AV device and camera. However, if it fails to play back images properly, change the HDMI output format setting.

- 1 Select [HDMI Out] in the [Set-up 2] menu, and press the four-way controller ().
- 2 Use the four-way controller () to select the HDMI output format, and press the **OK** button.

Auto	The maximum resolution that the AV device and camera support is automatically selected. (default setting)
1080i	1920×1080i
720p	1280×720p
480p	720×480p (when [Video Out] is set to [NTSC])
576p	720×576p (when [Video Out] is set to [PAL])

- 3 Press the **MENU** button.

The screen that was displayed before selecting the menu appears again.



When the HDMI output format is set to [1080i] or [720p], some screens displayed on the AV device may have a different design from those displayed on the camera.

Memo

7 Editing Images

This chapter describes how to edit the captured images.

Changing the Image Size	166
Processing Images	168
Developing RAW Images	174

Changing the Number of Recorded Pixels (Resize)

Changes the number of recorded pixels, and saves the image as a new file.



- Only JPEG images captured with this camera can be resized.
- Images already resized to 0.2M or 0.3M with this camera cannot be resized.

1 Select an image to resize in Playback mode, and press the four-way controller (▼).

The playback mode palette appears.

2 Use the four-way controller (▲▼◀▶) to select  (Resize), and press the OK button.

The screen to select the recorded pixels appears.

3 Use the four-way controller (◀▶) to select the number of recorded pixels, and press the OK button.

You can select one of the image sizes starting from one size smaller than that of the original image. The selectable sizes vary according to the original image size and aspect ratio.



4 Use the four-way controller (▲▼) to select [Save as], and press the OK button.

The resized image is saved as a new image.

Cropping Out Part of the Image (Cropping)

Crops out only the desired area of the selected image and saves it as a new image. The aspect ratio can also be changed.



- Only JPEG or RAW images captured with this camera can be cropped.
- Images already resized to 0.2M or 0.3M with this camera cannot be cropped.

1 Select an image to crop in Playback mode, and press the four-way controller (▼).

The playback mode palette appears.



2 Use the four-way controller (▲▼◀▶) to select  (Cropping), and press the OK button.

The cropping frame to specify the size and position of the area to crop appears on the screen.

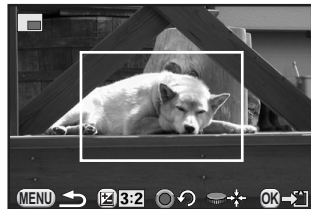
3 Specify the size and position of the area to crop by using the cropping frame.



Available operations

E-dial	Changes the size of the cropping frame.
Four-way controller (▲▼◀▶)	Moves the cropping frame.
 Av button	Changes the aspect ratio.
 /  button	Rotates the cropping frame (only when the cropping frame can be rotated).

4 Press the OK button.

The save confirmation screen appears.

5 Use the four-way controller (▲▼) to select [Save as], and press the OK button.

The cropped image is saved as a new image.

Processing Images with Digital Filters

You can edit captured images using digital filters. The following filters are available.

Filter Name	Effect	Parameter
Monochrome	Creates a monochrome image such as a black-and-white photo.	Filter Effect: OFF/Red/Green/Blue/Infrared Filter
		Toning (B-A): 7 levels
Toy Camera	Creates an image that looks as if taken with a toy camera.	Shading Level: Low/Medium/High
		Blur: Low/Medium/High
		Tone Break: Red/Green/Blue/Yellow
High Contrast	Enhances the contrast in the image.	Intensity: 1 to 5
Shading	Creates an image with darkened edges.	Shading Type: 6 types
		Shading Level: -3 to +3
Slim	Changes the horizontal and vertical ratio of images.	-8 to +8
HDR	Creates an image that looks like a high dynamic range image.	Low/Medium/High
Invert Color	Inverts image colors.	OFF/ON
Extract Color	Extracts one or two specific colors and makes the rest of the image black and white.	Extracted Color 1: Red/Magenta/Blue/Cyan/Green/Yellow
		Extractable Range of Color 1: 1 to 5
		Extracted Color 2: OFF/Red/Magenta/Blue/Cyan/Green/Yellow
		Extractable Range of Color 2: 1 to 5
Color	Adds a color filter to the image.	Color: Red/Magenta/Blue/Cyan/Green/Yellow
		Color Density: Light/Medium/Dark
Water Color	Creates an image that looks as though it was painted.	Intensity: Low/Medium/High
		Saturation: OFF/Low/Medium/High

Filter Name	Effect	Parameter
Posterization	Lessens the tone of the image to create an image that looks as though it was hand-drawn.	Intensity: 1 to 5
Fish-eye	Creates an image that looks as though taken with a fish-eye lens.	Low/Medium/High
Retro	Creates an image with the look of an old photo.	Toning (B-A): 7 levels
		Frame Composite: None/Thin/Medium/Thick
Soft	Creates an image with a soft focus throughout the image.	Soft Focus: Low/Medium/High
		Shadow Blur: OFF/ON
Sketch Filter	Creates an image that looks as though it was drawn with a pencil.	Contrast: Low/Medium/High
		Scratch Effect: OFF/ON
Miniature	Blurs part of the image to create a simulated miniature scene.	In-Focus Plane: -3 to +3
		In-Focus Width: Narrow/Middle/Wide
		In-Focus Plane Angle: Horizon/Vertical/Positive Slope/Negative Slope
		Blur: Low/Medium/High
Frame Composite	Adds a decorative frame to images.	Frame Type: 1/2/3
		Frame Width: Thin/Medium/Thick
Starburst	Creates an image with a special sparkling look by adding extra glitter to the highlights of night scenes or lights reflected on water.	Shape: Cross/Star/Snow Crystal/Heart/Musical Note
		Effect Density: Small/Medium/Large
		Size: Small/Medium/Large
		Angle: 0°/30°/45°/60°
Base Parameter Adj	Adjusts the parameters to create the desired image.	Brightness: -8 to +8
		Saturation: -3 to +3
		Hue: -3 to +3
		Contrast: -3 to +3
		Sharpness: -3 to +3



Only JPEG and RAW images captured with this camera can be edited using the Digital Filter.

- 1 Select an image for applying the digital filter in Playback mode, and press the four-way controller (▼).

The playback mode palette appears.

- 2 Use the four-way controller (▲▼◀▶) to select **0** (Digital Filter), and press the OK button.

The screen to select a filter appears.

- 3 Use the four-way controller (▲▼◀▶) to select a filter.

After selecting a filter, you can check the effect on the screen.

You can select a different image by turning the e-dial.

Proceed to Step 6 if you do not need to change the parameters.



- 4 Press the **Av** button.

The screen to adjust the parameter appears.

- 5 Use the four-way controller (▲▼) to select a parameter, and use the four-way controller (◀▶) to adjust the value.



- 6 Press the OK button.

The save confirmation screen appears.

- 7** Use the four-way controller (▲▼) to select [Use filters in combination] or [Save as], and press the **OK** button.

Select [Use filters in combination] when you want to apply additional filters to the same image. The screen that was displayed in Step 3 appears again.

If [Save as] was selected, the filter-processed image is saved as a new image.

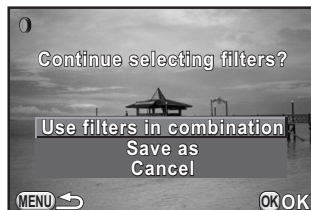

Up to 20 filters, including a digital filter used during shooting (p.130), can be combined to the same image.

Recreating Filter Effects

Retrieves the setting of an image with filter effects and applies the same filter effects to other images.

- 1** Select a filter-processed image in Playback mode.
- 2** Select **0** (Digital Filter) in the playback mode palette, and press the **OK** button.

- 3** Use the four-way controller (▲▼) to select [Recreating filter effects], and press the **OK** button.

The filter effects used for the selected image appear.



- 4** To check the parameter details, press the **INFO** button.

You can check the filter parameters. Press the **INFO** button again to return to the previous screen.



5 Press the OK button.

The image selection screen appears.

6 Use the e-dial to select an image for applying the same filter effects, and press the OK button.

You can only select an image that has not been processed with a filter.

The save confirmation screen appears.



7 Use the four-way controller (▲ ▼) to select [Save as], and press the OK button.

The filter-processed image is saved as a new image.



If [Searching for the original image] is selected in Step 3, the original image prior to digital filter application can be retrieved. If the original image is no longer stored on the SD Memory Card, the message [Original image, prior to digital filter application, is not found] appears.

Editing Out the Unwanted Red-eye Effect

You can correct images where the flash has caused the subject to appear with red eyes.



- Only JPEG images captured with this camera can be used for the Red-eye Edit function.
- The Red-eye Edit function does not work on images where red eyes cannot be detected on the camera. [The operation could not be completed correctly] appears in Step 2.

1 Select an image to edit in Playback mode, and press the four-way controller (▼).

The playback mode palette appears.

2 Use the four-way controller (▲▼◀▶) to select  (Red-eye Edit), and press the OK button.

The save confirmation screen appears.

3 Use the four-way controller (▲▼) to select [Save as], and press the OK button.

The edited image is saved as a new image.

You can convert captured RAW images into JPEG images, and save them as a new file.



Only RAW images captured with this camera can be developed. RAW images captured with other cameras cannot be developed on this camera.

Developing One RAW Image

- 1 Press the four-way controller (▼) in Playback mode.

The playback mode palette appears.

- 2 Use the four-way controller (▲▼◀▶) to select **RAW** (RAW Development), and press the **OK** button.

The screen to select a development method is displayed.

- 3 Use the four-way controller (▲▼) to select [Developing a Single Image], and press the **OK** button.

The parameters recorded in the image file appear.

Proceed to Step 6 if you do not need to change the parameters.

If there are no images that can be processed, [No image can be processed] appears.



- 4 Use the four-way controller (▲▼) to choose a parameter you want to change.

You can select a different image by turning the e-dial.

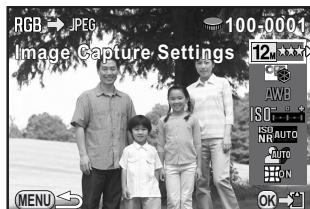

The following parameters can be changed.

Parameter	Value	Page
Aspect Ratio		p.117
Recorded Pixels	JPEG recorded pixels corresponding to the aspect ratio	p.118
Quality Level	★★★★★★★	p.119
Color Space	sRGB/AdobeRGB	p.119
Custom Image	Bright/Natural/Portrait/Landscape/Vibrant/Radiant/Muted/Bleach Bypass/Reversal Film/Monochrome/Cross Processing	p.126
White Balance	AWB/	p.120
Sensitivity	-2.0 to +2.0	—
High-ISO NR	Auto/Low/High	p.83
Shadow Correction	Auto/On/Off	p.124
Distortion Correction	On/Off	p.143

5 Use the four-way controller (◀▶) to change the value.

For Aspect Ratio, Recorded Pixels, Quality Level and Color Space, press the four-way controller (▶) and use the four-way controller (▲▼) to select an item.

For Custom Image and White Balance, press the four-way controller (▶) to display the setting screen.

6 Press the OK button.

The save confirmation screen appears.

7 Use the four-way controller (▲▼) to select [Save as], and press the OK button.

The RAW image is developed and saved as a new image.

8 Use the four-way controller (▲▼) to select [Continue] or [Exit], and press the OK button.

Select [Continue] to edit other images. The screen that was displayed in Step 4 appears again.

Developing Multiple RAW Images

You can develop multiple RAW images with the same settings.

- 1 Select [Developing Multiple Images] in Step 3 on p.174, and press the **OK** button.

The multi-image display screen appears.

Refer to p.150 for details on operations in the multi-image display screen.

- 2 Use the four-way controller (**▲ ▼ ◀ ▶**) to select the RAW images to be developed, and press the **OK** button.

- 3 Press the **Av** button.

The development confirmation screen appears.

- 4 Use the four-way controller (**▲ ▼**) to select [Develop images as shot] or [Develop images with modified settings], and press the **OK** button.

To change parameters, select [Develop images with modified settings].



- 5 Use the four-way controller (**▲ ▼ ◀ ▶**) to set [JPEG Recorded Pixels] and [JPEG Quality].

When [Develop images with modified settings] is selected in Step 4, refer to p.175 to change other parameters.



- 6 Press the **OK** button.

The save confirmation screen appears.

- 7 Use the four-way controller (**▲ ▼**) to select [Save as], and press the **OK** button.

The selected RAW images are developed and saved as new images.

8 Changing Additional Settings

This chapter describes how to change additional settings.

How to Operate the Set-up Menu	178
Camera Settings	180
File Management Settings	193



Perform general settings related to the camera in the [ Set-up] menu.





For details on how to use the menus, refer to “Using the Menus” (p.32).

Set-up Menu Items

Perform the following settings in the [ Set-up 1-3] menus.

Press the **MENU** button in Capture/Playback mode and use the four-way controller ( ) or e-dial to display the [ Set-up 1-3] menus.



Menu	Item	Function	Page
 1	Language/言語	Changes the language in which menus and messages appear.	p.184
	Date Adjustment	Sets the date format and time.	p.181
	World Time	Sets the display of the local date and time of the specified city so they can be displayed on the monitor in addition to the present location.	p.181
	Sound Effects	Switches the operation sound on/off and changes its volume.	p.180
	Guide Display	Sets the length of time that the guides are displayed on the monitor when the Capture mode is changed.	p.185
	LCD Display Settings	Adjusts the brightness and the color of the monitor.	p.187
	Flicker Reduction	Cuts down on screen flicker by setting the power frequency to that used in your region.	p.29
 2	Video Out	Sets the output format when connecting to an AV device with a video input terminal.	p.162
	HDMI Out	Sets the HDMI output format when connecting to an AV device with an HDMI terminal.	p.163
	USB Connection	Sets the USB connection mode when connecting to a computer.	p.201
	Folder Name	Sets the naming system for folders to store images.	p.195



Menu	Item	Function	Page
2	Create New Folder	Creates a new folder on the SD Memory Card.	p.195
	Power Saving	You can save battery power by setting the display to dim automatically when no operation is performed for 10 seconds.	p.184
	Auto Power Off	Sets the time until the camera turns off automatically.	p.184
3	Reset	Resets all settings.	p.190
	Pixel Mapping	Maps out and corrects any defective pixels in the CMOS sensor.	p.188
	Dust Removal	Cleans the CMOS sensor by shaking it.	p.224
	Format	Formats an SD Memory Card.	p.193
	Firmware Version Info	Displays the camera's firmware version.	p.191

Setting the Sound Effects, Date and Time, and Display Language

Setting the Sound Effects

You can turn the camera operation sound on or off, or change its volume. The sound for the following items can be set.





- In-focus
- AE-L (AE Lock operation sound)
- Self-timer
- Remote Control
- One Push File Format (operation sound when [One Push File Format] is assigned to the / button)
- Shutter Sound

1 Select [Sound Effects] in the [ Set-up 1] menu, and press the four-way controller ().

The [Sound Effects 1] screen appears.

2 Press the four-way controller (), and use the four-way controller ( ) to adjust the volume.

Select from six levels. When set to  (0), you can turn all the sound effects off.

3 Use the four-way controller ( ) to select an item, and use the four-way controller ( ) to select or .

Turn the e-dial to display the [Sound Effects 2] screen.

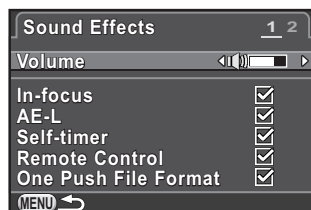

4 Press the **MENU** button twice.

The screen that was displayed before selecting the menu appears again.

Changing the Date and Time Display

You can change the initial date and time settings, and their display formats.

Set in [Date Adjustment] of the [↖ Set-up 1] menu.

↖ Setting the Date and Time (p.48)

Setting the World Time

The date and time set in “Initial Settings” (p.47) serve as the date and time of your present location.

Setting the destination in [World Time] enables you to display the local date and time on the monitor when traveling overseas.

- 1 Select [World Time] in the [↖ Set-up 1] menu, and press the four-way controller (▶).

The [World Time] screen appears.

- 2 Use the four-way controller (◀▶) to select ↗ (Destination) or ⚡ (Hometown) for [Setting the Time].

This setting is reflected in the date and time that appear in the guide display and control panel.

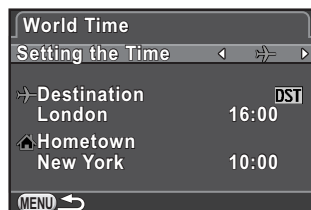

- 3 Press the four-way controller (▼) to select [↗ Destination], and press the four-way controller (▶).

The [↗ Destination] screen appears.

- 4 Use the four-way controller (◀▶) to select a destination city.

Turn the e-dial to change the region.

The location, time difference and current time of the selected city appear.

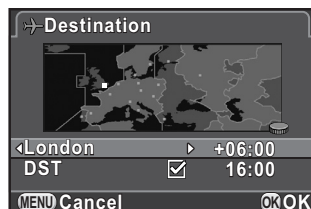

-
- 5** Press the four-way controller (▼) to select [DST], and use the four-way controller (◀▶) to select or .

Select if the destination city uses daylight saving time (DST).

- 6** Press the **OK** button.

The destination setting is saved and the screen that was displayed in Step 2 appears again.

- 7** Press the **MENU** button twice.

The screen that was displayed before selecting the menu appears again.



- Refer to “List of World Time Cities” (p.183) for cities that can be selected as a destination or hometown.
- Select [Hometown] in Step 3 to change the city and DST settings for the hometown.
- appears in the control panel and guide display (p.67) if [Setting the Time] is set to (Destination). Also, the video output setting (p.162) changes to the video output format for that city.

● List of World Time Cities

Region	City	Video Output Format	Region	City	Video Output Format
North America	Honolulu	NTSC	Africa/ West Asia	Istanbul	PAL
	Anchorage	NTSC		Cairo	PAL
	Vancouver	NTSC		Jerusalem	PAL
	San Francisco	NTSC		Nairobi	PAL
	Los Angeles	NTSC		Jeddah	PAL
	Calgary	NTSC		Tehran	PAL
	Denver	NTSC		Dubai	PAL
	Chicago	NTSC		Karachi	PAL
	Miami	NTSC		Kabul	PAL
	Toronto	NTSC		Male	PAL
	New York	NTSC		Delhi	PAL
	Halifax	NTSC		Colombo	PAL
Central and South America	Mexico City	NTSC	Kathmandu	PAL	
	Lima	NTSC	Dacca	PAL	
	Santiago	NTSC	East Asia	Yangon	NTSC
	Caracas	NTSC		Bangkok	PAL
	Buenos Aires	PAL		Kuala Lumpur	PAL
	Sao Paulo	PAL		Vientiane	PAL
	Rio de Janeiro	NTSC		Singapore	PAL
Europe	Lisbon	PAL		Phnom Penh	PAL
	Madrid	PAL		Ho chi Minh	PAL
	London	PAL		Jakarta	PAL
	Paris	PAL		Hong Kong	PAL
	Amsterdam	PAL		Beijing	PAL
	Milan	PAL		Shanghai	PAL
	Rome	PAL		Manila	NTSC
	Copenhagen	PAL	Taipei	NTSC	
	Berlin	PAL	Seoul	NTSC	
	Prague	PAL	Tokyo	NTSC	
	Stockholm	PAL	Guam	NTSC	
	Budapest	PAL	Oceania	Perth	PAL
	Warsaw	PAL		Adelaide	PAL
	Athens	PAL		Sydney	PAL
	Helsinki	PAL		Noumea	PAL
	Moscow	PAL		Wellington	PAL
	Africa/ West Asia	Dakar		PAL	Auckland
Algiers		PAL		Pago Pago	NTSC
Johannesburg		PAL			

Setting the Display Language

You can change the language in which the menus, error messages, etc. are displayed.

Set in [Language/言語] of the [ Set-up 1] menu.

 Setting the Display Language (p.47)

Setting the Monitor and the Menu Display

Minimizing Battery Consumption

You can set the monitor to dim and the camera to turn off automatically if unused for a certain length of time.

Set in [Power Saving] and [Auto Power Off] of the [ Set-up 2] menu.

Power Saving	The monitor brightness goes dim if the camera is unused for 10 seconds. The default setting is <input checked="" type="checkbox"/> (On). Press any button to return it to the normal brightness.
Auto Power Off	The power turns off automatically. Select from [1min.] (default setting), [3min.], [5min.], or [Off]. To turn it back on, press the power switch.



- The Power Saving function does not work while recording a movie.
- The Auto Power Off function does not work in the following situations.
 - when a slideshow is played back
 - when the camera is connected to a computer with a USB cable

Setting the Capture Mode Display Method

Sets the monitor display method in Capture mode.

- 1 Select [LCD View Options] in the [📷 Rec. Mode 3] menu, and press the four-way controller (▶).

The [LCD View Options] screen appears.

- 2 Press the four-way controller (▶), use the four-way controller (▲▼) to select a grid display type, and press the OK button.

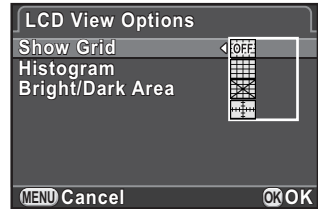

Select from (default setting), (4x4 Grid), (Golden Section) or (Scale).

- 3 Use the four-way controller (▲▼) to select [Histogram] or [Bright/Dark Area], and use the four-way controller (◀▶) to select or .

Histogram	Shows the brightness distribution of an image. (p.26)
Bright/Dark Area	Bright (overexposed) portions blink red and dark (underexposed) portions blink yellow. (p.28)

- 4 Press the MENU button twice.

The screen that was displayed before selecting the menu appears again.

Setting the Guide Display Time

Set the length of time that the guides (p.67) are displayed on the monitor when the Capture mode is changed.

Select from [3 sec.] (default setting), [10 sec.], [30 sec.] and [Off].

Set in [Guide Display] of the [🔧 Set-up 1] menu.

Setting the Initial Menu Tab Displayed

Set the initial menu tab displayed on the monitor when the **MENU** button is pressed.

- 1 Select [12. Save Menu Location] in the [C Custom Setting 2] menu, and press the four-way controller (▶).

The [12. Save Menu Location] screen appears.

- 2 Use the four-way controller (▲ ▼) to select [Reset Menu Location] or [Save Menu Location], and press the **OK** button.

Reset Menu Location	The [📷 Rec. Mode 1] menu ([🎞️ Movie 1] menu in 🎞️ mode, and [▶ Playback 1] menu in Playback mode) is always displayed first. (default setting)
Save Menu Location	The menu tab last selected is displayed first.

- 3 Press the **MENU** button.

The screen that was displayed before selecting the menu appears again.

Setting the Display for Instant Review

You can set the Instant Review (p.53) display settings.

- 1 Select [Instant Review] in the [📷 Rec. Mode 3] menu, and press the four-way controller (▶).

The [Instant Review] screen appears.

- 2 Press the four-way controller (▶), use the four-way controller (▲ ▼) to select a display time, and press the **OK** button.

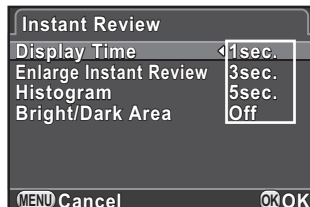

- 3** Use the four-way controller (▲▼) to select [Enlarge Instant Review], [Histogram] or [Bright/Dark Area], and use the four-way controller (◀▶) to select or .

Enlarge Instant Review	You can enlarge the image with the e-dial. (p.149)
Histogram	Shows the brightness distribution of an image. (p.26)
Bright/Dark Area	Bright (overexposed) portions blink red and dark (underexposed) portions blink yellow. (p.28)

- 4** Press the **MENU** button twice.

The screen that was displayed before selecting the menu appears again.

Adjusting the Brightness and the Color of the Monitor

Adjusts the brightness and the color of the monitor.

- 1** Select [LCD Display Settings] in the [**Set-up 1**] menu, and press the four-way controller (▶).

The [LCD Display Settings] screen appears.

- 2** Use the four-way controller (▲▼) to select the item to adjust.



Brightness Level	Changes the brightness of the monitor (-3 to +3).
Adjust: Blue-Amber	Adjusts the tone of the colors between blue (B7) and amber (A7).
Adjust: Green-Magenta	Adjusts the tone of the colors between green (G7) and magenta (M7).

- 3** Use the four-way controller (◀▶) to adjust the value.

Press the button to reset the adjustment value.

4 Press the **OK** button.



5 Press the **MENU** button.

The screen that was displayed before selecting the menu appears again.

Correcting Defective Pixels in the CMOS Sensor (Pixel Mapping)

Pixel Mapping is a function for mapping out and correcting defective pixels in the CMOS sensor.

Attach a 01 STANDARD PRIME or 02 STANDARD ZOOM lens to the camera.

1 Select [Pixel Mapping] in the [ Set-up 3] menu, and press the four-way controller ().

The [Pixel Mapping] screen appears.

2 Press the four-way controller () to select [Pixel Mapping], and press the **OK** button.

Defective pixels are mapped out and corrected, and the screen that was displayed before selecting the menu appears again.



- It takes about 30 seconds to correct the defective pixels.
- When the battery level is low, [Not enough battery power remaining to activate Pixel Mapping] is displayed on the monitor. Use the AC adapter kit (optional) or install a fully charged battery.

Selecting Settings to Save in the Camera (Memory)

You can select which function settings to save when the camera is turned off. The following function settings can be saved.

Function	Default Setting	Function	Default Setting
Flash Mode	<input checked="" type="checkbox"/>	Flash Exposure Comp.	<input checked="" type="checkbox"/>
Drive Mode	<input checked="" type="checkbox"/>	Focus Position	<input type="checkbox"/>
White Balance	<input checked="" type="checkbox"/>	Digital Filter	<input type="checkbox"/>
Custom Image	<input checked="" type="checkbox"/>	HDR Capture	<input type="checkbox"/>
Sensitivity	<input checked="" type="checkbox"/>	Playback Info Display	<input checked="" type="checkbox"/>
EV Compensation	<input checked="" type="checkbox"/>	File No.	<input checked="" type="checkbox"/>

- 1 Select [Memory] in the [📷 Rec. Mode 3] menu, and press the four-way controller (▶).

The [Memory 1] screen appears.

- 2 Use the four-way controller (▲▼) to select an item, and use the four-way controller (◀▶) to select or .

Turn the e-dial to display the [Memory 2] screen.

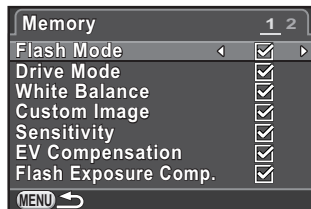

<input checked="" type="checkbox"/>	Settings are saved even when the camera is turned off.
<input type="checkbox"/>	Settings are cleared and returned to their default values when the camera is turned off.

- 3 Press the MENU button twice.

The screen that was displayed before selecting the menu appears again.



- Set [File No.] to (On) to continue the sequential numbering (four digits) for the file name even if a new folder is created.

<input checked="" type="checkbox"/>	The file number of the last image saved to the previous folder is saved and subsequent images are assigned sequential file numbers even if a new folder is created.
<input type="checkbox"/>	The file number of the first image saved to a folder returns to 0001 each time a new folder is created for saving images.

- When [Reset] of the [Set-up 3] menu is performed, all Memory settings return to the default values. (p.190)

Resetting the Menus

Resetting the Rec. Mode/Movie/Playback/Set-up Menu

Settings of the direct keys and for the items of the [Rec. Mode] menu, [Movie] menu, [Playback] menu, [Set-up] menu, and playback mode palette can be reset to default values.

- 1** Select [Reset] in the [Set-up 3] menu, and press the four-way controller ().

The [Reset] screen appears.

- 2** Press the four-way controller () to select [Reset], and press the OK button.

The settings are reset, and the screen that was displayed before selecting the menu appears again.



The following settings are not reset.

- Language/言語
- Date Adjustment
- The city and DST settings for World Time
- Flicker Reduction
- Video Out
- [**C** Custom Setting] menu

Resetting the Custom Setting Menu

Settings for the items of the [**C** Custom Setting] menu can be reset to default values.

- 1** Select [**Reset Custom Functions**] in the [**C Custom Setting 2**] menu, and press the four-way controller (▶).

The [**Reset Custom Functions**] screen appears.

- 2** Press the four-way controller (▲) to select [**Reset**], and press the **OK** button.

The settings are reset, and the screen that was displayed before selecting the menu appears again.

Checking the Camera Version Information

You can check the version information for software (firmware) in the camera. If an update file for the firmware is released, you can update the camera to the latest firmware version.



Refer to the PENTAX website for more information and procedural details regarding updates.

- 1** Select [**Firmware Version Info**] in the [**↶ Set-up 3**] menu, and press the four-way controller (▶).

The firmware versions for the camera and lens are displayed on the [**Firmware Version Info**] screen.

If an update file is saved on your SD Memory Card, you can run the update at a later time.



- 2** Press the **MENU** button twice.

The screen that was displayed before selecting the menu appears again.



- You cannot return a camera to its previous firmware version after updating it.
- Before running the update, be sure to save the data on your SD Memory Card to a computer or other location.
- When the battery level is low, [Not enough battery power remaining to update the firmware] is displayed on the monitor. Use the AC adapter kit (optional) or install a fully charged battery.

Formatting an SD Memory Card

Use this camera to format (initialize) an SD Memory Card that is unused or has been used on other devices.

Formatting deletes all the data saved on the SD Memory Card.



- Do not remove the SD Memory Card while formatting. The card may be damaged and become unusable.
- Formatting deletes all data, both protected and unprotected. Be aware.

1 Select **[Format]** in the [**↖ Set-up 3**] menu, and press the four-way controller (**▶**).

The **[Format]** screen appears.

2 Press the four-way controller (**▲**) to select **[Format]**, and press the **OK** button.

Formatting starts.

When formatting is completed, the screen that was displayed before selecting the menu appears again.

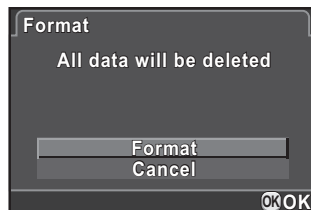

When an SD Memory Card is formatted, the volume label assigned to the card is "Q10". When this camera is connected to a computer, the SD Memory Card is recognized as a removable disk with the name "Q10".

Protecting Images from Deletion (Protect)

You can protect images from being accidentally deleted.



Even protected images are deleted if the inserted SD Memory Card is formatted.

- 1 Press the four-way controller (▼) in Playback mode.**

The playback mode palette appears.

- 2 Use the four-way controller (▲▼◀▶) to select  (Protect), and press the OK button.**

The screen to select how to change the settings is displayed.

- 3 Use the four-way controller (▲▼) to select [Single Image] or [All Images], and press the OK button.**

If you selected [All Images], proceed to Step 5.

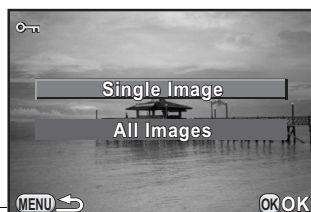

- 4 Use the e-dial to select an image to protect.**

- 5 Press the four-way controller (▲) to select [Protect], and press the OK button.**

Select [Unprotect] to cancel the protection of the image.

The image is protected and the  icon appears at the top right of the screen.

Repeat Steps 4 and 5 to protect other images.

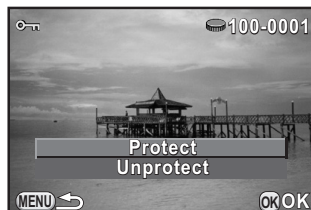

- 6 Press the MENU button.**

The camera returns to Playback mode.

Changing the Naming System for Folders

When images are captured with this camera, a folder is automatically created and the captured images are stored in the new folder. Each folder name consists of a sequential number from 100 to 999 and a string of 5 characters. You can change the folder name in [Folder Name] of the [Set-up 2] menu.

Date	The two digits of the month and day on which the picture was taken are assigned as the folder name in the form of [xxx_MMDD]. [MMDD] (month and day) appears according to the display format set in [Date Adjustment] (p.48). (default setting) Example) 101_0125: Folder for images taken on January 25th
PENTX	The folder name is assigned in the form of [xxxPENTX]. Example) 101PENTX



A maximum of 500 images can be stored in a single folder. When the number of captured images exceeds 500, a new folder is created to store the additional images. In Exposure Bracketing shooting, images will be stored in the same folder until shooting is completed, even if the number of images exceeds 500.

Creating New Folders

You can create a new folder on the SD Memory Card. A folder is created with the number following the number of the folder currently being used.

- 1** Select [Create New Folder] in the [Set-up 2] menu, and press the four-way controller (▶).

The [Create New Folder] screen appears.

- 2** Press the four-way controller (▲) to select [Create folder], and press the OK button.

A folder with a new number is created when the next still picture or movie is saved.

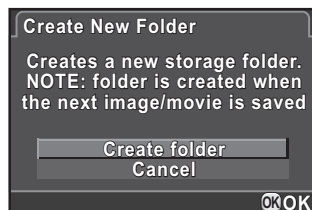

Only one folder can be created using this operation. Multiple empty folders cannot be created consecutively.

Setting the DPOF Settings

By adding DPOF (Digital Print Order Format) settings to stored images on the SD Memory Card, you can specify the number of copies and whether to imprint the date on the images in advance and order conventional photograph prints by taking this SD Memory Card to a store for printing.



- DPOF settings cannot be applied to RAW images and movies.
- You can make DPOF settings for up to 999 images.

1 Press the four-way controller (▼) in Playback mode.

The playback mode palette appears.

2 Use the four-way controller (▲▼◀▶) to select (DPOF), and press the OK button.

The screen to select how to change the settings is displayed.

3 Use the four-way controller (▲▼) to select [Single Image] or [All Images], and press the OK button.

If you selected [All Images], proceed to Step 5.

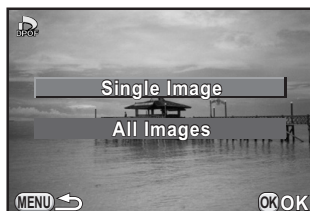

4 Use the e-dial to select an image to set DPOF settings.

5 Use the four-way controller (▲▼) to select the number of copies.

You can set up to 99 copies.

 appears at the top right of the screen for images with DPOF settings.

To cancel the DPOF settings, set the number of copies to [00].

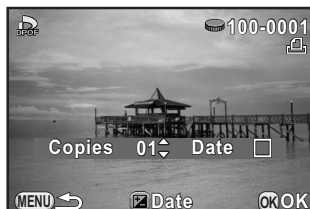

6 Press the  **Av** button to select or for printing the date.

<input checked="" type="checkbox"/>	The date will be printed.
<input type="checkbox"/>	The date will not be printed.

Repeat Steps 4 to 6 to make DPOF settings for other images.

7 Press the **OK** button.

The DPOF settings for the selected image is saved and the camera returns to Playback mode.



- Depending on the printer or printing equipment at the photo processing lab, the date may not be printed on the pictures.
- The number of copies specified in the All Images setting applies to all the images, and that specified in the Single Image setting is canceled.

Memo

9 Connecting to a Computer

This chapter explains how to connect the camera to a computer, install the supplied CD-ROM, etc.

Manipulating Captured Images on a Computer	200
Saving Images on a Computer	201
Using the Provided Software	203

Manipulating Captured Images on a Computer

The captured still pictures and movies can be transferred to a computer by connecting the camera using a USB cable, and RAW images can be developed using the provided software “SILKYPIX Developer Studio”. We recommend the following system requirements to connect the camera to a computer or to use the software.

● Windows

OS	Windows XP (SP3 or later, 32-bit Home/Pro), Windows Vista (32-bit, 64-bit), Windows 7 (32-bit, 64-bit) <ul style="list-style-type: none"> • Installation requires administrator rights • Can be run as a 32-bit application on any 64-bit Edition of Windows
CPU	Intel Pentium-compatible processor (Pentium 4, Athlon XP or higher recommended) <ul style="list-style-type: none"> • Supports multi-core processors (Intel Core i5, i7; Core 2 Quad, Duo; AMD Phenom II X4, X6; Athlon II X2, X4; and other)
RAM	1 GB minimum (2 GB or more recommended)
HDD	For installing and starting up the program: 100 MB minimum of free space For saving image files: Approx. 10 MB/file
Monitor	1024×768 dots, 24-bit full color or higher
Other	Input devices such as a keyboard and mouse

● Macintosh

OS	Mac OS X 10.5, 10.6, or 10.7
CPU	Intel processor-compatible, Power PC
RAM	1 GB minimum (2 GB or more recommended)
HDD	For installing and starting up the program: 100 MB minimum of free space For saving image files: Approx. 10 MB/file
Monitor	1024×768 dots, 24-bit full color or higher
Other	Input devices such as a keyboard and mouse



- Use the provided software to develop RAW images captured with this camera.
- QuickTime is required to play back movies transferred to a computer. You can download it from the following site:
<http://www.apple.com/quicktime/download/>

Setting the USB Connection Mode

Set the USB connection mode when connecting the camera to a computer.

- 1** Select [USB Connection] in the [ Set-up 2] menu, and press the four-way controller (▶).
- 2** Use the four-way controller (▲ ▼) to select [MSC] or [PTP], and press the **OK** button.

MSC	Mass Storage Class (default setting) A general-purpose driver program that handles devices connected to the computer via USB as a memory device.
PTP	Picture Transfer Protocol A protocol that allows transfer of digital images and control of digital cameras via USB.

Unless otherwise specified, select [MSC].

- 3** Press the **MENU** button.

The screen that was displayed before selecting the menu appears again.

Connecting the Camera and a Computer

Connect the camera to a computer using the provided USB cable I-USB7.

- 1 Turn the computer on.
- 2 Turn off the camera, and use the USB cable to connect the PC/AV terminal of the camera and the computer.

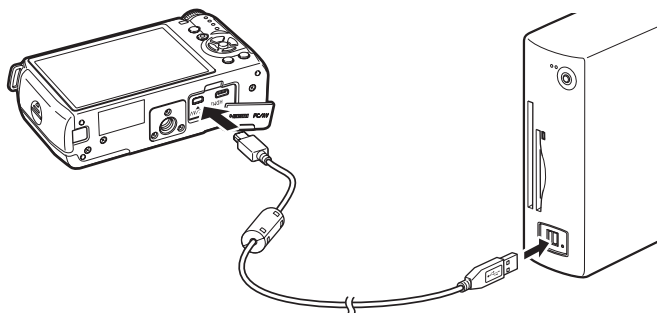

- 3 Turn the camera on.

The camera is recognized as a removable disk or an SD Memory Card with a volume label "Q10".

If the "Q10" dialog appears when the camera is turned on, select [Open folder to view files using Windows Explorer] and click the OK button.

- 4 Save the captured images to the computer.

Copy the image file(s) or folder(s) to the hard disk of the computer.

- 5 Disconnect the camera from the computer.



The camera cannot be operated while it is connected to the computer. To operate the camera, terminate the USB connection on the computer, then turn off the camera and remove the USB cable.

“SILKYPIX Developer Studio 3.0 for PENTAX” is included on the CD-ROM (S-SW131). With the SILKYPIX Developer Studio, you can develop RAW files, adjust the color of the images and other settings, and save the new images as a JPEG or TIFF file.

Installing the Software

You can install the software from the provided CD-ROM. When multiple accounts have been setup on a computer, log on with an account that has administrative rights before installing the software.

1 Turn the computer on.

Make sure no other software is running.

2 Place the CD-ROM into the CD/DVD drive on the computer.

The [PENTAX Software Installer] screen appears.

If the [PENTAX Software Installer] screen does not appear

- **For Windows**

- 1 Click [My Computer] from the Start menu.
- 2 Double-click the [CD/DVD drive (S-SW131)] icon.
- 3 Double-click the [Setup.exe] icon.

- **For Macintosh**

- 1 Double-click the CD/DVD (S-SW131) icon on the desktop.
- 2 Double-click the [PENTAX Installer] icon.

3 Click [SILKYPIX Developer Studio 3.0 for PENTAX].

For Macintosh, follow the instructions on the screen to perform subsequent steps.

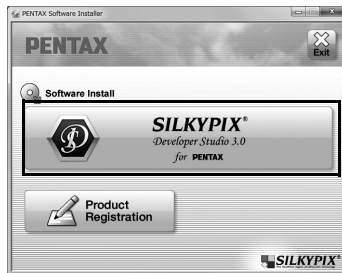

4 Select the desired language in the [Choose Setup Language] screen, and click [OK].

5 When the [InstallShield Wizard] screen appears in the selected language, click [Next].

Follow the instructions on the screen to perform subsequent steps.



Start SILKYPIX Developer Studio and see the help menu for details on using the software program.

Regarding Product Registration

To better serve you, please take a moment to register your software.

Click [Product Registration] on the screen in Step 3 on p.204.

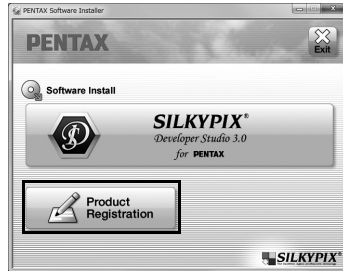

A world map for Internet Product Registration is displayed. If a computer is connected to the Internet, click the displayed country or region and then follow the instructions to register your software.

Note that you can only register online if your country or area is shown.

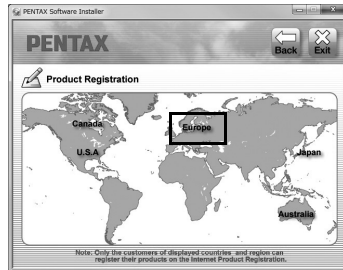

Memo

10 Using the Flash

This chapter provides details on the built-in flash and describes how to take pictures with an external flash.

Using the Built-in Flash	208
Using an External Flash (Optional)	211

Flash Characteristics in Each Exposure Mode



Using the Flash in Tv Mode

- When taking a moving subject, you can use the flash to change the blur effect.
- The aperture value automatically changes according to the ambient brightness.

Using the Flash in Av Mode

- You can set the desired aperture value to take a flash photograph when you want to change the depth of field or shoot a subject farther away.
- The shutter speed automatically changes with the ambient brightness.

Using the Slow-speed Sync

You can use Slow-speed Sync in  (Night Scene Portrait) or **SCN** (Scene) mode or **Tv** (Shutter Priority Automatic Exposure) mode when shooting portraits with the sunset in the background. Both the portrait and the background are captured beautifully.  and  can be used in **P** (Program Automatic Exposure) or **Av** (Aperture Priority Automatic Exposure) mode.



- Slow-speed Sync slows down the shutter speed. Use the Shake Reduction function or turn off the Shake Reduction function and use a tripod to avoid camera shake. The picture will also blur if the subject moves.
- Slow-speed Sync can also be performed with an external flash.

Using the Trailing Curtain Sync

Trailing Curtain Sync discharges the flash immediately before the shutter closes. When shooting moving objects with a slow shutter speed, Trailing Curtain Sync and Slow-speed Sync produce different effects depending on when the flash is discharged.

For example, when shooting a moving car with Trailing Curtain Sync, trailing light is captured while the shutter is open and the flash captures the car immediately before the shutter is closed. Therefore, the picture will include a sharp, well-lit car with trailing light behind it.

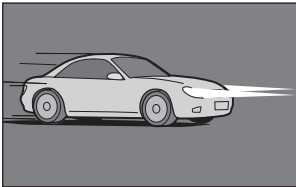

Slow-speed Sync
(Leading Curtain Sync)

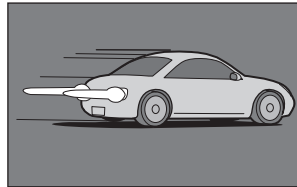

Trailing Curtain Sync



Trailing Curtain Sync slows down the shutter speed. Use the Shake Reduction function, or turn off the Shake Reduction function and use a tripod to avoid camera shake.

Distance and Aperture when Using the Built-in Flash

Relationships among the guide number, aperture and distance must be considered when shooting with the flash to obtain a correct exposure. Calculate and adjust the shooting conditions if the flash output is not sufficient.

Sensitivity	Built-in Flash Guide Number	Sensitivity	Built-in Flash Guide Number
ISO 100	Approx. 4.9	ISO 1600	Approx. 20
ISO 200	Approx. 7	ISO 3200	Approx. 28
ISO 400	Approx. 10	ISO 6400	Approx. 40
ISO 800	Approx. 14		

Calculating Shooting Distance from Aperture Value

The following equation calculates the effective distance of the flash.

Maximum flash distance $L1 = \text{Guide number} \div \text{Aperture value}$

Minimum flash distance $L2 = \text{Maximum flash distance} \div 6^*$

* The value 6 used in the formula above is a fixed value which applies only when using the built-in flash alone.

Example)

When the sensitivity is ISO 200 and the aperture value is F2.0

$L1 = 7 \div 2.0 = \text{approx. } 3.5 \text{ (m)}$

$L2 = 3.5 \div 6 = \text{approx. } 0.6 \text{ (m)}$

Therefore, the flash can be used in the range of about 0.6 m to 3.5 m. However, the built-in flash in this camera cannot be used when the distance is 0.7 m or less. When the flash is used at closer than 0.7 m, it causes vignetting in the picture corners, light is distributed unevenly and a picture may be overexposed.

Calculating Aperture Value from Shooting Distance

The following equation calculates the aperture value for shooting distances.

Aperture value $F = \text{Guide number} \div \text{Shooting distance}$

Example)

When the sensitivity is ISO 200 and the shooting distance is 3 m, the aperture value is:

$F = 7 \div 3 = \text{approx. } 2.3$

If the resulting number (2.3, in the above example) is not available as a lens aperture, a smaller number that is closest (2.0, in the above example) is generally used.

Lens Compatibility with the Built-in Flash

Depending on the lens used with this camera, even if a lens without a hood is attached, the use of the built-in flash may not be available or may be limited due to vignetting.

The built-in flash is not available due to vignetting

Lens Name
03 FISH-EYE

Using an optional external flash AF540FGZ, AF360FGZ, AF200FG or AF160FC enables a variety of flash modes, such as P-TTL auto flash mode, depending on the external flash being used.

✓: Available ×: Not available

Camera Function \ Flash	Built-in Flash	AF540FGZ AF360FGZ	AF200FG AF160FC
Red-eye reduction flash	✓	✓	✓
Auto flash discharge	✓	✓	✓
Automatically switching to the flash sync speed	✓	✓	✓
Aperture value is automatically set in P mode and Tv mode.	✓	✓	✓
P-TTL auto flash	✓	✓	✓
Slow-speed Sync	✓	✓	✓
Flash exposure compensation	✓	✓	✓
Auto zoom flash head	×	✓	×
AF assist light of external flash	×	×	×
Trailing Curtain Sync* ¹	✓	✓	×
Contrast-control-sync flash mode	×	×	×
Slave flash	×	×	×
Wireless flash	×	×	×

*¹ 1/2000 sec. or slower for a 01 STANDARD PRIME/02 STANDARD ZOOM lens (1/250 sec. or slower for external flash units), 1/13 sec. or slower for a 03 FISH-EYE/04 TOY WIDE/05 TOY TELEPHOTO lens.



- The built-in flash will not discharge if the camera is connected to an external flash.
- Flashes with reversed polarity (the center contact on the hot shoe is minus) cannot be used due to the risk of damaging the camera and flash.





- When an external flash is attached directly to the hot shoe of the camera, the camera's center of gravity is greatly shifted, making it difficult to take pictures. When using an external flash, it is recommended to use an extension cord to separate the camera and flash. (p.213)
- To use an AF160FC flash with the camera, a commercially available step-up ring or similar accessory is needed.
- To use the Auto flash mode of an AF540FGZ or AF360FGZ flash, set the camera's capture mode to **M** (Manual Exposure) mode and built-in flash to (Flash Off).

Using P-TTL Mode

You can use the P-TTL auto flash with an AF540FGZ, AF360FGZ, AF200FG or AF160FC flash unit.

- 1** Remove the cover of the hot shoe, and attach the external flash.
- 2** Turn on the camera and the external flash.
- 3** Set the external flash mode to [P-TTL].
- 4** Confirm that the external flash is fully charged, and then take a picture.



- The maximum sync speed available with an external flash is 1/250 sec.
- The P-TTL auto flash is only available with an AF540FGZ, AF360FGZ, AF200FG or AF160FC flash unit.
- For details such as operation method and effective distance, please refer to the external flash manual.
- The flash does not discharge if the subject is bright enough when the flash mode is set to ^A or . Therefore, it may not be suitable for daylight-sync shooting.
- Never pop up the built-in flash when any external flash unit is attached to the camera. The built-in flash will hit the external flash.

Red-eye Reduction

As with the built-in flash, the red-eye reduction function is available with an external flash. The red-eye reduction function works by discharging the flash twice even when only an external flash is used. However, this function may not be available on some flashes or may have restrictions for usage conditions. Refer to the chart on p.211.

Connecting an External Flash with an Extension Cord

Attach the Hot Shoe Adapter F₆ (optional) to the camera hot shoe and an Off-Camera Shoe Adapter F (optional) to the bottom of the external flash, and connect these with the Extension Cord F5P (optional) as shown in the illustration below. The Off-Camera Shoe Adapter F can be mounted to your tripod using the tripod screw.

The built-in flash will not discharge if the camera is connected to an external flash.

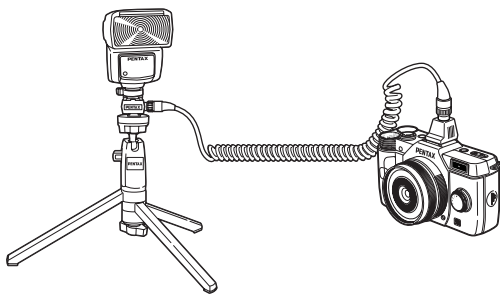

- Do not combine with accessories that have a different number of contacts, such as a Hot Shoe Grip, as a malfunction may occur.
- Combining with flashes from other manufacturers may cause equipment breakdown.

11 Appendix

Default Settings	216
Functions Available with Various Lens Combinations	222
Cleaning the CMOS Sensor	224
Error Messages	225
Troubleshooting	227
Main Specifications	230
Index	236
WARRANTY POLICY	242

Default Settings

The table below shows the factory default settings.

The functions set in Memory (p.189) are saved even when the camera is turned off.

Reset Setting

Yes: The setting returns to the default setting with the reset function (p.190).

No: The setting is saved even after reset.

Direct Keys



Item	Default Setting	Reset Setting	Page
Sensitivity	ISO AUTO 100 - 3200	Yes	p.73
White Balance	AWB (Auto)	Yes	p.120
Flash Mode	Depends on Capture mode	Yes	p.55
Drive Mode	<input type="checkbox"/> (Single Frame Shooting)	Yes	p.78 p.95 p.96 p.99

Quick Dial





Position	Default Setting	Reset Setting	Page
1	Smart Effect [Brilliant Color]	Yes	p.132
2	Smart Effect [Unicolor Bold]		
3	Smart Effect [Vintage Color]		
4	Smart Effect [Cross Processing]		

[📷 Rec. Mode] Menu

Item		Default Setting	Reset Setting	Page
Custom Image		Bright	Yes	p.126
Digital Filter		Not use any filters	Yes	p.130
Image Capture Settings	Aspect Ratio	4:3	Yes	p.117
	File Format	JPEG	Yes	p.117
	JPEG Recorded Pixels	12M (4000×3000)	Yes	p.118
	JPEG Quality	★★★ (Best)	Yes	p.119
	Color Space	sRGB	Yes	p.119
Focus Settings	Focus Method	AF	Yes	p.84
	Autofocus Method	☒ (AF Select (25 Points))	Yes	p.85
	MF Assist	Off	Yes	p.90
	Focus Peaking	Off	Yes	p.91
AE Metering		 (Multi-segment)	Yes	p.82
ND Filter		Off	Yes	p.142
HDR Capture		Off	Yes	p.125
Multi-exposure	Number of Shots	2 times	Yes	p.103
	Auto EV Adjustment	☐ (Off)	Yes	
Interval Shooting	Interval	00:00'01"	Yes	p.101
	Number of Shots	2 images	Yes	
	Start Interval	Now	Yes	
	Start Time	12:00 AM/00:00	Yes	
D-Range Setting	Highlight Correction	Auto	Yes	p.123
	Shadow Correction	Auto	Yes	p.124
High-ISO NR		Auto	Yes	p.83
Distortion Correction		On	Yes	p.143
Quick Dial		Smart Effect	Yes	p.132

Item		Default Setting	Reset Setting	Page	
Green Button	Green Button	Green Button	Yes	p.138	
	One Push File Format	Cancel after 1 shot	<input checked="" type="checkbox"/> (On)		Yes
		JPEG/RAW/RAW+ File Format	All RAW+		Yes
	Action in M Mode		P LINE	Yes	p.141
	E-dial in Program		P SHIFT	Yes	p.140
LCD View Options	Show Grid	 (Off)	Yes	p.185	
	Histogram	<input type="checkbox"/> (Off)	Yes		
	Bright/Dark Area	<input type="checkbox"/> (Off)	Yes		
Instant Review	Display Time	1 sec.	Yes	p.186	
	Enlarge Instant Review	<input type="checkbox"/> (Off)	Yes		
	Histogram	<input type="checkbox"/> (Off)	Yes		
	Bright/Dark Area	<input type="checkbox"/> (Off)	Yes		
Memory	Focus Position, Digital Filter, HDR Capture	<input type="checkbox"/> (Off)	Yes	p.189	
	Other than the above functions	<input checked="" type="checkbox"/> (On)	Yes		
Shake Reduction		 (On)	Yes	p.93	
Input Focal Length		0000.0 mm	Yes	p.223	

[Movie] Menu

Item		Default Setting	Reset Setting	Page
Recorded Pixels		 (1920×1080, )	Yes	p.105
Sound		 (On)	Yes	
Exposure Setting		Auto	Yes	
Movie SR		 (On)	Yes	
Interval Movie	Interval	1 sec.	Yes	p.109
	Recording Time	5 sec.	Yes	
	Start Interval	Now	Yes	
	Start Time	12:00 AM / 00:00	Yes	

Playback Mode Palette

Item	Default Setting	Reset Setting	Page
Image Rotation	—	—	p.157
Digital Filter	Monochrome	Yes	p.168
Red-eye Edit	—	—	p.173
Resize	Maximum size according to the setting	—	p.166
Cropping	Maximum size according to the setting	—	p.167
Index	—	—	p.153
Protect	—	No	p.194
Slideshow	—	Yes	p.156
Save Cross Processing	—	Yes	p.129
RAW Development	Recorded Pixels: 12M Quality Level: ★★★	Yes	p.174
Movie Editing	—	—	p.112
DPOF	—	No	p.196

[▶ Playback] Menu

Item	Default Setting	Reset Setting	Page
Slideshow	Interval	3 sec.	p.155
	Screen Effect	Off	
	Repeat Playback	<input type="checkbox"/> (Off)	
Quick Zoom	Off	Yes	p.148
Bright/Dark Area	<input type="checkbox"/> (Off)	Yes	
Delete All Images	—	—	p.160

[🔧 Set-up] Menu

Item		Default Setting	Reset Setting	Page
Language/言語		English	No	p.184
Date Adjustment		01/01/2012	No	p.181
World Time	World Time setting	🏠 (Hometown)	Yes	p.181
	Hometown (City)	According to initial setting	No	
	Hometown (DST)	According to initial setting	No	
	Destination (City)	Same as Hometown	No	
	Destination (DST)	Same as Hometown	No	
Sound Effects	Volume	3	Yes	p.180
	Setting	All <input checked="" type="checkbox"/> (On)		
Guide Display		3 sec.	Yes	p.185
LCD Display Settings		±0	Yes	p.187
Flicker Reduction		50 Hz	No	p.29
Video Out		According to initial setting	No	p.162
HDMI Out		Auto	Yes	p.163
USB Connection		MSC	Yes	p.201
Folder Name		Date	Yes	p.195
Create New Folder		—	—	p.195
Power Saving		<input checked="" type="checkbox"/> (On)	Yes	p.184
Auto Power Off		1 min.	Yes	p.184
Reset		—	—	p.190
Pixel Mapping		—	—	p.188
Dust Removal	Dust Removal	—	—	p.224
	Start-up Action/ Shut-down Action	<input type="checkbox"/> (Off)	Yes	
Format		—	—	p.193
Firmware Version Info		—	—	p.191

[C Custom Setting] Menu

Item	Default Setting	Reset Setting	Page
1. AE-L with AF Locked	On	Yes	p.81
2. Link AE to AF Point	Off	Yes	p.82
3. Auto Bracketing Order	0 – +	Yes	p.78
4. Shake Reduction Options	Mode1	Yes	p.94
5. WB When Using Flash	Auto White Balance	Yes	p.121
6. AWB in Tungsten Light	Subtle Correction	Yes	—
7. AF Release Options	Focus-priority	Yes	p.86
8. AF Assist Light	On	Yes	p.85
9. AF with Remote Control	Off	Yes	p.98
10. Flash When Retracted	Discharge Flash	Yes	p.58
11. Release While Charging	Off	Yes	p.58
12. Save Menu Location	Reset Menu Location	Yes	p.186
13. Electronic Shutter	Disable	Yes	p.222
Reset Custom Functions	—	—	p.191

Functions Available with Various Lens Combinations

A group	01 STANDARD PRIME 02 STANDARD ZOOM 06 TELEPHOTO ZOOM
B group	04 TOY WIDE 05 TOY TELEPHOTO
C group	03 FISH-EYE
D group	ADAPTER Q FOR K MOUNT LENS

✓ : Available
: Restricted
× : Not available

Function \ Lens Type	A group	B group	C group	D group
Autofocus	✓	×	×	×
Manual focus	✓	✓	✓	✓
Quick-Shift focus	✓	×	×	×
Autofocus Method	✓	×	×	×
Aperture control	✓	×	×	×
ND filter on the lens	✓	×	×	×
Shutter on the lens	✓	×	×	✓ ^{*7}
Electronic shutter	✓ ^{*1}	✓	✓	✓
Multi-segment metering	✓	✓	×	✓
AUTO/SCN/BC mode	✓	# ^{*2}	# ^{*2}	# ^{*8}
P/Tv/Av mode	✓	# ^{*2}	# ^{*2}	# ^{*8}
M mode	✓	# ^{*2} ^{*3}	# ^{*2} ^{*3}	# ^{*8}
B mode	✓	# ^{*2}	# ^{*2}	# ^{*8}
P-TTL Auto Flash	✓ ^{*4}	✓ ^{*5}	# ^{*5} ^{*6}	# ^{*5} ^{*9}

*1 Set [13. Electronic Shutter] to [Enable] in the [C Custom Setting 2] menu. You can take pictures at higher speeds with the electronic shutter than with the lens shutter.

Ex.) With a 01 STANDARD PRIME lens

Pictures taken at 1/2000 sec. or slower with the lens shutter and 1/2000 sec. to 1/8000 sec. with the electronic shutter.

*2 Aperture value fixed.

*3 **Bulb** mode not available in **M** mode. Allows the use of a slow shutter speed of up to 2 sec.

*4 Built-in flash: 1/2000 sec., external flash: 1/250 sec.

*5 Flash sync speed is approx. 1/13 sec.

- *6 Light is unevenly distributed.
- *7 When using the lens shutter built-in to the adapter
- *8 Set the aperture manually.
- *9 Light may be unevenly distributed.

Using a K-Mount Lens

A K-mount lens can be attached to this camera with the use of the optional Adapter Q for K Mount Lens. When a K-mount lens is used, the focal length must be set manually for functions such as Shake Reduction, since the focal length cannot be obtained automatically.

1 Make sure that [Shake Reduction] is set to (On), and turn the camera off.

Refer to “Taking Pictures Using the Shake Reduction Function” (p.93) for details.

2 Attach the mount adapter and lens, and turn the camera on.

The [Input Focal Length] screen appears.

3 Use the four-way controller (▲▼◀▶) to set the focal length.

Select the focal length for the lens to be attached. When using a zoom lens, select the actual focal length at the zoom setting being used.

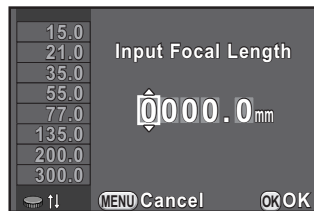

You can also use the e-dial to select a value from those displayed on the left side of the monitor.

4 Press the OK button.

The camera is ready to take a picture.



- To change the focal length setting, use [Input Focal Length] in the [📷 Rec. Mode 3] menu.
- When the Adapter Q for K Mount Lens is used, set the aperture manually regardless of the capture mode setting. Images are taken in **Av** (Aperture Priority Automatic Exposure) mode, even when the capture mode is set to **AUTO** (Auto Picture), **SCN** (Scene), **BC** (Blur Control), **P** (Program Automatic Exposure), or **Tv** (Shutter Priority Automatic Exposure).
- Refer to the Adapter Q for K mount lens manual for details.

If the CMOS sensor becomes dirty or dusty, shadows may appear in the image in certain situations such as when shooting against a white background. This indicates that the CMOS sensor must be cleaned.

Removing Dust by Shaking the CMOS Sensor (Dust Removal)

Shaking the CMOS sensor removes dust that has collected.

- 1 Select [Dust Removal] in the [Set-up 3] menu, and press the four-way controller (▶).

The [Dust Removal] screen appears.

- 2 Press the OK button.

The Dust Removal function is activated by shaking the CMOS sensor.

To activate the Dust Removal function every time the camera is turned on and off, set [Start-up Action] and [Shut-down Action] to .

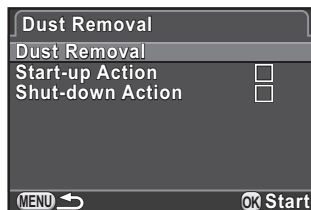

When Dust Removal is completed, the camera returns to the [Set-up 3] menu.



Use a brush-less blower to remove dirt and dust from the CMOS sensor. Using a blower with a brush may scratch the CMOS sensor. Do not wipe the CMOS sensor with a cloth.































Error Messages	Description
Memory card full	The SD Memory Card is full and no more images can be saved. Insert a new SD Memory Card or delete unwanted images. (p.42, p.158) You may be able to save more images if you change the image capture settings. (p.116)
No more image/movie can be saved	The SD Memory Card has 65,535 files saved on it and no more files can be saved. Insert a new SD Memory Card or delete unwanted files. (p.42, p.158)
No image	There are no images that can be played back on the SD Memory Card.
This image cannot be displayed	You are trying to play back an image in a format not supported by this camera. You may be able to play it back on another brand of camera or a computer.
No card in the camera	There is no SD Memory Card inserted in the camera. (p.42)
Memory card error	The SD Memory Card has a problem, and image capture and playback are impossible. It may be viewable on a computer but not with this camera.
Card is not formatted	The SD Memory Card you have inserted is unformatted or has been formatted on another device and is not compatible with this camera. Use the card after formatting it with this camera. (p.193)
Card is locked	The write-protect switch on the SD Memory Card you have inserted is locked. Unlock the SD Memory Card.
This image cannot be enlarged	You are trying to enlarge an image that cannot be enlarged.
This image is protected	You are trying to delete an image that is protected. Remove protection from the image. (p.194)
Not enough battery power remaining to activate Pixel Mapping	Appears during Pixel Mapping if the battery level is insufficient. Install a fully charged battery, or use the AC adapter kit (optional). (p.40)

Error Messages	Description
Not enough battery power remaining to update the firmware	Appears when trying to update the firmware if the battery level is insufficient. Install a fully charged battery, or use the AC adapter kit (optional). (p.40)
Unable to update firmware. There is a problem with the firmware update file	Unable to update the firmware. The update file is damaged. Try downloading the update file again. (p.191)
Image folder cannot be created	The maximum folder number (999) and file number (9999) are being used, and no more images can be saved. Insert a new SD Memory Card or format the card. (p.193)
Unable to store image	The image could not be saved because of an SD Memory Card error.
Settings not stored	The DPOF settings could not be saved because SD Memory Card is full. Delete unwanted images and perform DPOF setting again. (p.158)
The operation could not be completed correctly	The camera was unable to measure the manual white balance (p.122) or use HDR Capture (p.125). Try the operation again.
No more images can be selected	You cannot select more than the maximum number of images for Index (p.153) and Select & Delete (p.158).
No image can be processed	There are no images that can be processed using Digital Filter (p.168) or RAW Development (p.174) function.
This image cannot be processed	Appears when you try to perform Resize (p.166), Cropping (p.167), Digital Filter (p.168), Red-eye Edit (p.173) or RAW Development (p.174) for images captured with other cameras, or when you try to perform Resize or Cropping for minimum file size images.
The camera failed to create an image	The creation of an index print image failed. (p.153)
This function is not available in the current mode	You are trying to set a function that is not available when the capture mode is set to AUTO (Auto Picture), SCN (Scene) or MOVIE (Movie) mode.
The camera will turn off to prevent damage from overheating	The camera will turn off because its internal temperature gets too hot. Leave the camera turned off until it has had time to cool down before turning on the camera again.

In rare cases, the camera may not operate correctly due to static electricity. This can be remedied by taking the battery out and putting it back in again. After these procedures are done, if the camera operates correctly, it does not require any repairs.

We recommend checking the following items before contacting a service center.

Problem	Cause	Remedy
The camera does not turn on	Battery is not installed	Check if battery is installed. If not, install a fully charged battery.
	Battery is not installed properly	Check the orientation of battery. (p.38)
	The battery power is low	Install a fully charged battery, or use the AC adapter kit (optional). (p.40)
The shutter cannot be released	The built-in flash is charging	Wait until charging is finished.
	There is no available space on the SD Memory Card	Insert an SD Memory Card with available space or delete unwanted images. (p.42, p.158)
	Recording	Wait until recording is finished.
Autofocus does not work	The subject is difficult to focus on	Autofocus cannot work well for subjects that have low contrast (the sky, white walls, etc.), dark colors, intricate designs, rapidly-moving objects or scenery shot through a window or a net-like pattern. Lock focus on another object located at the same distance as your subject, then aim at the target and press the shutter release button fully. Alternatively, use manual focus. (p.90)
	The subject is not in the focusing area	Position the subject in the focus frame on the monitor. If the subject is outside the focusing area, aim the camera at the subject and lock the focus, then compose a picture and press the shutter release button fully. (p.89)

Problem	Cause	Remedy
Autofocus does not work	The subject is too close	Move away from the subject and take a picture.
	The focus method is set to MF	Set [Focus Method] to AF . (p.84)
The focus cannot be locked	[Autofocus Method] is set to [Face Detection] or [Tracking]	Autofocus is not locked (focus lock) when [Autofocus Method] is set to [Face Detection] or [Tracking]. The camera will continue focusing on the subject while the shutter release button is pressed halfway. If there is a subject that you want to focus on, set [Autofocus Method] to [AF Select (25 Points)], [Select], or [Spot], and use the focus lock. (p.89)
	The capture mode is set to  ,  ,  ,  or  of SCN mode.	Set the capture mode to any mode other than  (Moving Object),  (Night Snap),  (Pet),  (Kids) or  (Stage Lighting) of SCN (Scene) mode. (p.70)
The AE Lock function does not operate	The shutter speed is set to Bulb	Set the shutter speed to any mode other than Bulb . (p.76)
The built-in flash does not discharge	When the flash mode is set to  ^A or  , the flash will not discharge if the subject is bright	Set the flash mode to  (Flash On) or  (Flash On+Red-eye Reduction). (p.55)
	The capture mode is set to  ,  ,  ,  , HDR ,  , HDR (HDR),  ,  or  of SCN mode	Set SCN (Scene) mode to any mode other than  (Sunset),  (Blue Sky),  (Night Scene),  (Night Scene HDR), HDR (HDR),  (Backlight Silhouette),  (Candlelight),  (Stage Lighting) or  (Museum). (p.70)
The USB connection with a computer does not work properly	The USB connection mode is set to [PTP]	Set [USB Connection] in the [ Set-up 2] menu to [MSC]. (p.201)

Problem	Cause	Remedy
Shake Reduction does not work	The Shake Reduction function is off	Set [Shake Reduction] to on. (p.93)
	Shutter speed is too slow for the Shake Reduction function to be effective when panning or shooting night scenes, etc.	Set [Shake Reduction] to off and use a tripod.
	The subject is too close	Move away from the subject, or turn off the Shake Reduction function and use a tripod.
The shooting settings cannot be changed	The quick dial is set to the position 1 to 4	When you use the quick dial to take pictures, priority is given to the settings saved in the quick dial. (p.133)

Model Description

Type	Lens-interchangeable SL digital camera
Lens Mount	PENTAX bayonet Q-mount
Compatible Lens	Q-mount lenses

Image Capture Unit

Image Sensor	Type: CMOS sensor with a primary color filter, Size: 1/2.3-inch
Effective Pixels	Approx. 12.4 megapixels
Total Pixels	Approx. 12.76 megapixels
Dust Removal	Image sensor cleaning using ultrasonic vibrations "DR II"
Sensitivity (Standard Output)	ISO AUTO: ISO 100 to ISO 6400 (1/3 EV step) *Up to ISO 1600 when the shutter speed is set to 2 sec. or slower.
Image Stabilizer	Sensor shift Shake Reduction

File Formats

File Formats	RAW (DNG), JPEG (Exif 2.3), DCF2.0 compliant
Recorded Pixels	JPEG: 16:9 9M (4000×2248) 6M (3456×1944) 4M (2688×1512) 2M (1920×1080) 3:2 10M (4000×2664) 8M (3456×2304) 5M (2688×1792) 2M (1920×1280) 4:3 12M (4000×3000) 9M (3456×2592) 5M (2688×2016) 3M (1920×1440) 1:1 9M (2992×2992) 6M (2592×2592) 4M (2016×2016) 2M (1440×1440) RAW: 4:3 12M (4000×3000)
Quality Level	RAW: DNG (12 bit) JPEG: ★★★ (Best), ★★ (Better), ★ (Good) RAW and JPEG simultaneously recordable
Color Space	sRGB, AdobeRGB
Storage Media	SD, SDHC, and SDXC Memory Cards
Storage Folder	Date (100_1018, 100_1019...)/ PENTX (100PENTX, 101PENTX...)

LCD Monitor

Type	TFT color LCD monitor, wide angle viewing
Size	3.0 inches
Dots	Approx. 460,000 dots
Adjustment	Brightness and colors adjustable
Display	Field of View: approx. 100%, Grid display (4 × 4 Grid, Golden Section, Scale display), Bright/dark area warning, Histogram



White Balance

Auto	TTL by CMOS image sensor
Preset	Daylight, Shade, Cloudy, Fluorescent Light (D : Daylight Color, N : Daylight White, W : Cool White, L : Warm White), Tungsten, Flash, CTE , Manual
Manual	Configuration on monitor
Fine Adjustment	Adjustable ± 7 steps on A-B axis and G-M axis

Focusing Mechanism

Type	Contrast detection AF
Brightness Range	EV 1 to 18 (ISO100)
Focus Method	AF/MF switching
Autofocus Method	Face Detection, Tracking, AF Select (25 Points), Select, Spot
AF Assist Light	Dedicated LED AF assist light
MF Assist	Off/ $\times 2/\times 4$

Exposure Control

Type	TTL image sensor metering, multi-segment metering, center-weighted metering, and spot metering
Metering Range	EV 1 to 17 (ISO 100, F1.9 lens), +2 EV with Electronic Shutter enabled, +2 EV using the ND filter
Exposure Modes	Auto Picture modes: Standard, Portrait, Landscape, Macro, Night Scene Portrait, Sunset, Blue Sky, Forest Scene modes: Portrait, Landscape, Macro, Moving Object, Night Scene Portrait, Sunset, Blue Sky, Night Scene, Night Scene HDR*, Night Snap, Food, Quick Macro*, Pet, Kids, Forest, Surf & Snow, HDR*, Backlight Silhouette, Candlelight, Stage Lighting, Museum Program, Shutter Priority, Aperture Priority, Manual, Bulb, Blur Control* *JPEG only
EV Compensation	± 3 EV (1/3 EV step)
AE Lock	Can be assigned to the  /  button from the menu.

Shutter	Lens shutter: 1/2000 - 30 seconds (1/3 EV step, 1/8000 - 30 seconds when Electronic Shutter is enabled), Bulb *When using a lens that has no lens shutter; shooting at 1/8000 - 2 seconds with the electronic shutter is available, Bulb shooting is not available.
Aperture	From wide open to F8 *Not available when using a lens that has no lens shutter.
ND Filter	Off/On *Not available when using a lens that has no lens shutter.

Drive Modes

Mode Selection	Single frame, Continuous (Hi, Lo), Self-timer (12s, 2s), Remote Control (0 sec., 3 sec., continuous), Auto Bracketing (3 frames, remote control)
Continuous Shooting	Approx. 5 fps, JPEG (i2M/★★★/Continuous Hi): up to 5 frames Approx. 1.5 fps, JPEG (i2M/★★★/Continuous Lo): up to 100 frames

Built-in Flash

Type	Built-in retractable P-TTL flash, Guide number: approx. 7 (ISO200/m), approx. 4.9 (ISO100/m) Angle of view coverage: equivalent to 28 mm in 35 mm format
Flash Modes	P-TTL, Red-eye Reduction, Slow-speed Sync, Trailing Curtain Sync
Sync Speed	Lens shutter: 1/2000 seconds, Electronic shutter: 1/13 seconds, Used with external flash unit: 1/250 seconds
Flash Exposure Compensation	-2.0 to +1.0 EV

Capture Functions

Custom Image	Bright, Natural, Portrait, Landscape, Vibrant, Radiant, Muted, Bleach Bypass, Reversal Film, Monochrome, Cross Processing
Noise Reduction	High-ISO NR
Dynamic Range Setting	Highlight Correction, Shadow Correction
Lens Correction	Distortion Correction
Digital Filter	Toy Camera, High Contrast, Shading, Slim, HDR, Invert Color, Extract Color, Color, Water Color, Posterization, Fish-eye
HDR Capture	Auto, HDR 1, HDR 2
Multi-exposure	Number of shots: 2-9, Exposure adjusted automatically.
Interval Shooting	Shooting interval: 1 sec. to 24 hr., Start Interval setting: immediately, from the set time, Number of shots: up to 999 images
Smart Effect	Brilliant Color, Unicolor Bold, Vintage Color, Cross Processing, Warm Fade, Tone Expansion, Bold Monochrome, Water Color, Vibrant Color Enhance, USER 1-3

Movie

File Format	MPEG-4 AVC/H.264
Recorded Pixels	FullHD (1920×1080, 16:9 , 30 fps), HD (1280×720, 16:9 , 30 fps), VGA (640×480, 4:3 , 30 fps)
Sound	Built-in monaural microphone
Recording Time	Up to 25 minutes; automatically stops recording if the internal temperature of the camera becomes high.
Custom Image	Bright, Natural, Portrait, Landscape, Vibrant, Radiant, Muted, Bleach Bypass, Reversal Film, Monochrome, Cross Processing
Digital Filter	Toy Camera, High Contrast, Shading, Slim, HDR, Invert Color, Extract Color, Color, Water Color, Posterization, Fish-eye
Interval Movie	Recording interval: 1 sec., 5 sec., 10 sec., 30 sec., 1 min., 5 min., 10 min., 30 min., 1 hr., Recording time: 5 sec. to 99 hr., Start Interval setting: immediately, from the set time

Playback Functions

Playback View	Single frame, multi-image display (4, 9, 20, 42, 90 segmentation), display magnification (up to 16×, scrolling and quick magnification available), rotating, histogram (Y histogram, RGB histogram), bright/dark area warning, detailed information display, folder display, calendar display, slideshow
Delete	Delete single image, delete all images, select & delete, delete folder, delete instant review image
Digital Filter	Monochrome, Toy Camera, High Contrast, Shading, Slim, HDR, Invert Color, Extract Color, Color, Water Color, Posterization, Fish-eye, Retro, Soft, Sketch Filter, Miniature, Frame Composite, Starburst, Base Parameter Adjustment
RAW Development	File Format (JPEG), Aspect Ratio, Color Space, Custom Image, White Balance, Sensitivity, High-ISO NR, Shadow Correction, Distortion Correction
Edit	Resize, Cropping (aspect ratio adjustment available), Index, Movie Editing (divide or delete selected frames), Capturing a JPEG still picture from a movie, Red-eye Edit, Save the RAW file data in the buffer memory

Customization

Custom Functions	13 items
Mode Memory	12 items
Button/Dial Customization	ⓘ/🗑 button: Green Button, Preview, One Push File Format, AE Lock, Enable AF Quick Dial: Smart Effect, Custom Image, Digital Filter, Aspect Ratio
World Time	World Time settings for 75 cities (28 time zones)

Power Supply

Battery Type	Rechargeable Lithium-ion Battery D-LI68
AC Adapter	AC Adapter Kit K-AC115 (optional)
Battery Life	<p>Number of recordable images (with 50% flash usage): approx. 250 images, (without flash usage): approx. 270 images Playback time: approx. 160 minutes</p> <p>* Tested in compliance with CIPA standard using a new rechargeable lithium-ion battery under the temperature of 23°C. Actual results may vary depending on the shooting conditions/circumstances.</p>

Interfaces

Connection Port	USB 2.0 (high-speed compatible)/AV output terminal, HDMI output terminal (Type D)
USB Connection	MSC/PTP
Video Output Format	NTSC/PAL

Dimensions and Weight

Dimensions	Approx. 102.0 mm (W) × 58.0 mm (H) × 33.5 mm (D) (excluding the operation parts and protrusion)
Weight	Approx. 200 g (loaded and ready with the dedicated battery and SD Memory Card), Approx. 180 g (body only)

Accessories

Package Contents	<p>USB Cable I-USB7, Strap O-ST131, Rechargeable Lithium-ion Battery D-LI68, Battery Charger D-BC68P, AC plug cord, Software (CD-ROM) S-SW131 <Mounted on the camera> Hot shoe cover Fκ, Body mount cover</p>
Software	SILKYPIX Developer Studio 3.0 for PENTAX

● Approximate Image Storage Capacity and Playback Time

When using the fully charged battery

Battery	Temperature	Normal Shooting	Flash Photography		Playback Time
			50% Use	100% Use	
D-LI68	23°C	270	250	240	160 minutes

The image storage capacity (normal recording and flash use 50%) is based on measuring conditions in accordance with CIPA standards, while other data is based on our measuring conditions. Some deviation from the above figures may occur in actual use depending on the selected capture mode and shooting conditions.

● Approximate Image Storage Capacity by Size





























When using a 2 GB SD Memory Card

Aspect Ratio	Recorded Pixels	JPEG Quality			RAW
		★★★	★★	★	
16:9	9M (4000×2248)	561	1067	1797	90
	6M (3456×1944)	845	1607	2708	–
	4M (2688×1512)	1263	2402	4046	–
	2M (1920×1080)	2115	4020	6772	–
3:2	10M (4000×2664)	503	957	1613	88
	8M (3456×2304)	629	1196	2015	–
	5M (2688×1792)	998	1897	3196	–
	2M (1920×1280)	2115	4020	6772	–
4:3	12M (4000×3000)	418	796	1341	85
	9M (3456×2592)	561	1067	1797	–
	5M (2688×2016)	998	1897	3196	–
	3M (1920×1440)	1510	2871	4837	–
1:1	9M (2992×2992)	561	1067	1797	90
	6M (2592×2592)	845	1607	2708	–
	4M (2016×2016)	1263	2402	4046	–
	2M (1440×1440)	2115	4020	6772	–

* The maximum number of recordable images is 65,535 images, regardless of the amount of available space on the SD Memory Card.

* The number of storable images may vary depending on the subject, shooting conditions, selected capture mode and SD Memory Card, etc.

Symbols



-  (Playback)
 - button..... 19, 21, 59
-  (Green/Delete)
 - button..... 19, 21, 60, 138
-  **Av** (EV Compensation)
 - button 19, 21, 77
- [ Rec. Mode] menu 63, 217
- [ Movie] menu 65, 105, 218
- [ Playback] menu 147, 219
- [ Set-up] menu 178, 220
- [**C** Custom Setting]
 - menu 65, 221
-  Standard 68
-  Portrait 68, 69
-  Landscape 68, 69
-  Macro 68, 69
-  Night Scene Portrait ... 68, 69
-  Sunset 68, 69
-  Blue Sky 68, 69
-  Forest 68, 69
-  Moving Object 69
-  Night Scene 69
-  Night Scene HDR 69
-  Night Snap 69
-  Food 69
-  Quick Macro 69
-  Pet 69
-  Kids 69
-  Surf & Snow 69
-  Backlight Silhouette 70
-  Candlelight 70
-  Stage Lighting 70
-  Museum 70
-  Movie 107

A



- AC adapter 40











- Action in M Mode 141
- Adding the date (DPOF) 197
- AdobeRGB 119
- AE Lock 80
- AE Metering 82
- AF area 87
- AF Assist Light 17, 85
- AF** (Autofocus) 84
- AF frame 53
- AF Select (25 Points) 85
- Aperture Priority Automatic
 - Exposure mode **Av** 74
- Aspect
 - Ratio 105, 116, 117, 167
- AUTO** (Auto Picture)
 - mode 52, 68
- Auto Flash 55
- Auto Picture mode
 - AUTO** 52, 68
- Auto Power Off 184
- Autofocus **AF** 84
- Autofocus Method 85
- Av** (Aperture Priority Automatic
 - Exposure) mode 74
- AV device 161
- AWB** (White Balance) 120







B





- Backlight Silhouette  70
- Base Parameter Adj
 - (Digital Filter) 169
- Battery 37
- BC** (Blur Control) mode 71
- Bleach Bypass
 - (Custom Image) 126
- Blue Sky  68, 69
- Blur Control mode **BC** 71

- Bold Monochrome
 - (Smart Effect) 134
- Bracketing shooting 78
- Bright (Custom Image) 126
- Bright areas 28, 123
- Bright/Dark Area
 - warning 148, 185, 187
- Brightness adjustment 123
- Brilliant Color
 - (Smart Effect) 134
- Built-in flash 55
- Bulb** (Bulb) 76
- Bulb shooting 76
- C**
- Calendar display 152
- Camera shake 93, 106
- Candlelight  70
- Capture mode 67
- Card access lamp 17
- Center-weighted metering 82
- Charging the battery 37
- City 183
- Cleaning the sensor 224
- Cloudy (White Balance) 120
- Color (Digital Filter) 130, 168
- Color adjustment 187
- Color Space 119
- Computer 199
- Connection cable cover 40
- Continuous Autofocus 90
- Continuous playback 155
- Continuous Shooting 99
- Contrast (Custom Image) 127
- Control panel 24, 31
- Correcting distortion 143
- Creating new folders 195
- Cropping images 167
- Cross Processing
 - (Custom Image) 126
- Cross Processing
 - (Smart Effect) 134
- CTE** (White Balance) 120
- Custom Image 126
- [**C** Custom Setting]
 - menu 65, 221
- D**
- Dark areas 28, 124
- Date Adjustment 49, 181
- Daylight (White Balance) 120
- Default settings 216
- Delete 60, 158
- Delete all images 160
- Delete folder 159
- Deleting single image 60
- Depth of field 71, 92
- Destination 181
- Detailed information display 27
- Developing Raw images 174
- Digital Filter 130, 168
- Direct keys 30, 62, 216
- Discharge 55
- Display language 184
- Distortion Correction 143
- DPOF 196
- D-Range Setting 124
- Drive Mode 62
- DST 48, 182
- Dust Removal 224
- Dynamic Range 123
- E**
- E-dial 19, 21
- E-dial in Program 140
- Effect 134
- Electronic Shutter 222
- Enable AF 88
- Enlarge Instant
 - Review 149, 187
- Error messages 225
- EV Compensation 77

- Av** (EV Compensation)
 - button 19, 21, 77
 - Exposure 73
 - Exposure Bracketing 78
 - Exposure mode 74
 - Exposure Setting 106
 - External flash 211
 - Extract Color
 - (Digital Filter) 130, 168
- F**
 - Face Detection
 - (Autofocus Method) 85
 - File Format 117
 - Filter 130, 168
 - Filter Effect
 - (Custom Image) 128
 - Firmware 191
 - Firmware Version Info 191
 - Fish-eye
 - (Digital Filter) 130, 169
 - Flash 55, 207
 - Flash (White Balance) 120
 - Flash Exposure
 - Compensation 56
 - Flash Off 55
 - Flash On 55
 - Flash pop-up switch 19, 57
 - Flicker Reduction 29
 - Fluorescent Light
 - (White Balance) 120
 - Focus Lock 89
 - Focus Method 84
 - Focus Peaking 91
 - Focus Settings 85
 - Focusing 84
 - Focusing ring 90
 - Folder display 151
 - Folder Name 195
 - Food  69
 - Forest  68, 69
- Format 193
- Four-way controller
 - (▲▼◀▶) 19, 21, 30, 62
- Frame Composite
 - (Digital Filter) 169
- Frame rate 105
- G**
 -  (Green/Delete)
 - button 19, 21, 60, 138
 - Guide Display 67, 185
 - Guide indicators 29
 - Guide number 209
- H**
 - HDMI output format 163
 - HDMI terminal 161
 - HDR** 70
 - HDR (Digital Filter) 130, 168
 - HDR Capture 125
 - High Contrast
 - (Digital Filter) 130, 168
 - High Dynamic Range
 - shooting 125
 - High/Low Key Adj
 - (Custom Image) 127
 - High-ISO NR 83
 - Highlight Correction 123
 - Histogram 26, 28, 185, 187
 - Hometown 181
 - Hot shoe 17
 - Hue (Custom Image) 127
- I**
 - Image Capture Settings 116
 - Image finishing tone 126
 - Image Rotation 157
 - Image storage capacity 235
 - Index 153
 - INFO** button 19, 21, 22, 25
 - Initial settings 47
 - Initializing a memory card 193

- Input Focal Length 223
- Installing software 203
- Instant Review 53, 186
- Interval Movie 109
- Interval Shooting 101
- Invert Color
 - (Digital Filter) 130, 168
- ISO sensitivity 73
- J**
- JPEG 117
- JPEG Quality 119
- JPEG Recorded Pixels 118
- K**
- Kids  69
- L**
- Landscape  68, 69
- Landscape
 - (Custom Image) 126
- Language setting 47, 184
- LCD Display Settings 187
- LCD View Options 185
- Leading Curtain Sync 209
- Lens 44, 222
- Lens information contacts 17
- Lens mount index 44
- Lens unlock button 45
- Locking the exposure 80
- Locking the focus 89
- M**
- M** (Manual Exposure)
 - mode 74
- Macintosh 200
- Macro  68, 69
- Manual focus **MF** 84, 90
- Manual White Balance 122
- Memory 189
- Memory Card 42
- MENU** button 19, 21, 32
- Menu operation 32
- Menu tab display 186
- Metering method 82
- MF Assist 90
- MF** (Manual focus) 84, 90
- Microphones 17
- Miniature (Digital Filter) 169
- Mode dial 19, 67
- Monitor 22, 187
- Monochrome
 - (Custom Image) 126
- Monochrome
 - (Digital Filter) 168
- Movie 105
- Movie Editing 112
- [ Movie] menu 65, 105, 218
- Movie SR 106
- Moving Object  69
- MSC 201
- Multi-exposure 103
- Multi-image display 150
- Multi-segment metering 82
- Museum  70
- Muted (Custom Image) 126
- N**
- Natural (Custom Image) 126
- ND Filter 142
- Night Scene  69
- Night Scene HDR  69
- Night Scene Portrait  68, 69
- Night Snap  69
- Noise Reduction 83
- NTSC 162
- O**
- OK** button 19, 21
- One Push File Format 139
- P**
- P** (Program Automatic Exposure) mode 74

- PAL 162
 - PC/AV terminal 161, 202
 - Pet  69
 - Pixel Mapping 188
 - Pixels 105, 118
 - Playback 59
 -  (Playback)
 - button 19, 21, 59
 - [ Playback] menu 147, 219
 - Playback mode
 - palette 146, 219
 - Playing back movies 111
 - Portrait  68, 69
 - Portrait (Custom Image) 126
 - Posterization
 - (Digital Filter) 130, 169
 - Power Saving 184
 - Power supply 46
 - Power switch 19, 21, 46
 - Preview 92, 138
 - Printing 196
 - Product registration 205
 - Program Automatic
 - Exposure mode **P** 74
 - Protect 194
 - Provided software 203
 - PTP 201
 - P-TTL (Auto Flash) 212
- Q**
- Quality Level 119
 - Quick dial 19, 132
 - Quick Macro  69
 - Quick Zoom 148
- R**
- Radiant (Custom Image) 126
 - RAW 117
 - RAW Development 174
 - [ Rec. Mode] menu 63, 217
 - Recorded Pixels 105, 118
 - Red-eye Edit 173
 - Red-eye Reduction 55, 212
 - Release-priority 86
 - Remote Control 96
 - Remote control receiver 17
 - Reset 190
 - Resize 166
 - Retro (Digital Filter) 169
 - Reversal Film
 - (Custom Image) 126
 - Rotation 157
- S**
- Saturation
 - (Custom Image) 127
 - Save Cross Processing 129
 - Save RAW data 26, 59
 - Save Settings 136
 - Save Thumbnail 137
 - Saving frequently
 - used functions 132
 - SCN** (Scene) mode 69
 - SD Memory Card 42
 - Select (Autofocus Method) 85
 - Select & Delete 158
 - Self-timer 95
 - Self-timer lamp 17
 - Sensitivity 73
 - [ Set-up] menu 178, 220
 - Shade (White Balance) 120
 - Shading
 - (Digital Filter) 130, 168
 - Shadow Correction 124
 - Shake Reduction 93
 - Sharpness
 - (Custom Image) 127
 - Shooting information 22
 - Show Grid 185
 - TAv** (Shutter & Aperture Priority Automatic Exposure)
 - mode 74

Shutter Priority Automatic	
Exposure mode Tv	74
Shutter release button	19, 21
SILKYPIX Developer	
Studio	203
Sketch Filter	
(Digital Filter)	169
Slideshow	155
Slim (Digital Filter)	130, 168
Slow-speed Sync	55, 208
Smart Effect	134
Soft (Digital Filter)	169
Software	203
Sound	105
Sound Effects	180
Speaker	17
Specifications	230
Spot (Autofocus Method)	85
Spot metering	82
sRGB	119
Stage Lighting 	70
Standard 	68
Standard display	22, 25
Starburst (Digital Filter)	169
Strap	36
Sunset 	68, 69
Surf & Snow 	69
T	
Tone Expansion	
(Smart Effect)	134
Toning (Custom Image)	128
Toy Camera	
(Digital Filter)	130, 168
Tracking	
(Autofocus Method)	85
Trailing Curtain Sync	55, 209
Tungsten (White Balance)	120
Tv (Shutter Priority Automatic	
Exposure) mode	74

U

Unicolor Bold	
(Smart Effect)	134
Updating software	191
USB Connection	201
USB Connection mode	201
USER	136

V

Vibrant (Custom Image)	126
Vibrant Color Enhance	
(Smart Effect)	134
Video Output Format	162
Video terminal	161
Vintage Color	
(Smart Effect)	134

W

Warm Fade	
(Smart Effect)	134
Water Color	
(Digital Filter)	130, 168
Water Color	
(Smart Effect)	134
White Balance	120
Windows	200
World Time	181
Write-protect	5

Z

Zoom display	149
Zoom lens	54

All PENTAX cameras purchased through authorized bona fide photographic distribution channels are guaranteed against defects of material or workmanship for a period of twelve months from date of purchase. Service will be rendered, and defective parts will be replaced without cost to you within that period, provided the equipment does not show evidence of impact, sand or liquid damage, mishandling, tampering, battery or chemical corrosion, operation contrary to operating instructions, or modification by an unauthorized repair shop. The manufacturer or its authorized representatives shall not be liable for any repair or alterations except those made with its written consent and shall not be liable for damages from delay or loss of use or from other indirect or consequential damages of any kind, whether caused by defective material or workmanship or otherwise; and it is expressly agreed that the liability of the manufacturer or its representatives under all guarantees or warranties, whether expressed or implied, is strictly limited to the replacement of parts as hereinbefore provided. No refunds will be made on repairs by non-authorized PENTAX service facilities.

Procedure During 12-month Warranty Period

Any PENTAX which proves defective during the 12-month warranty period should be returned to the dealer from whom you purchased the equipment or to the manufacturer. If there are no representatives of the manufacturer in your country, send the equipment to the manufacturer, with postage prepaid. In this case, it will take a considerable length of time before the equipment can be returned to you owing to the complicated customs procedures required. If the equipment is covered by warranty, repairs will be made and parts replaced free of charge, and the equipment will be returned to you upon completion of servicing. If the equipment is not covered by warranty, regular charges of the manufacturer or of its representatives will apply. Shipping charges are to be borne by the owner. If your PENTAX was purchased outside of the country where you wish to have it serviced during the warranty period, regular handling and servicing fees may be charged by the manufacturer's representatives in that country. Notwithstanding this, your PENTAX returned to the manufacturer will be serviced free of charge according to this procedure and warranty policy. In any case, however, shipping charges and customs clearance fees to be borne by the sender. To prove the date of your purchase when

required, please keep the receipt or bills covering the purchase of your equipment for at least a year. Before sending your equipment for servicing, please make sure that you are sending it to the manufacturer's authorized representatives or their approved repair shops, unless you are sending it directly to the manufacturer. Always obtain a quotation for the service charge, and only after you accept the quoted service charge, instruct the service station to proceed with the servicing.

- **This warranty policy does not affect the customer's statutory rights.**
- **The local warranty policies available from PENTAX distributors in some countries can supersede this warranty policy. Therefore, we recommend that you review the warranty card supplied with your product at the time of purchase, or contact the PENTAX distributor in your country for more information and to receive a copy of the warranty policy.**



The CE Mark is a Directive conformity mark of the European Union.

For customers in USA

STATEMENT OF FCC COMPLIANCE

This device complies with Part 15 of the FCC Rules. Operation is subject to the following two conditions: (1) This device may not cause harmful interference, and (2) this device must accept any interference received, including interference that may cause undesired operation.

Changes or modifications not approved by the party responsible for compliance could void the user's authority to operate the equipment.

This equipment has been tested and found to comply with the limits for a Class B digital device, pursuant to part 15 of the FCC Rules.

These limits are designed to provide reasonable protection against harmful interference in a residential installation. This equipment generates, uses and can radiate radio frequency energy and, if not installed and used in accordance with the instructions, may cause harmful interference to radio communications. However, there is no guarantee that interference will not occur in a particular installation.

If this equipment does cause harmful interference to radio or television reception, which can be determined by turning the equipment off and on, the user is encouraged to try to correct the interference by one or more of the following measures:

- Reorient or relocate the receiving antenna.
- Increase the separation between the equipment and receiver.
- Connect the equipment into an outlet on a circuit different from that to which the receiver is connected.
- * Consult the dealer or an experienced radio/TV technician for help.

For customers in Canada

This Class B digital apparatus complies with Canadian ICES-003.

Pour les utilisateurs au Canada

Cet appareil numérique de la classe B est conforme à la norme NMB-003 du Canada.

FOR CALIFORNIA, U.S.A. ONLY

Perchlorate Material-special handling may apply.

The lithium battery used in this camera contains perchlorate material, which may require special handling.

See www.dtsc.ca.gov/hazardouswaste/perchlorate

Declaration of Conformity

According to 47CFR, Parts 2 and 15 for
Class B Personal Computers and Peripherals

We: PENTAX RICOH IMAGING AMERICAS
CORPORATION

Located at: 633 17th Street, Suite 2600
Denver, Colorado 80202 U.S.A.
Phone: 800-877-0155 FAX: 303-790-1131

Declare under sole responsibility that the product identified herein complies with 47CFR Parts 2 and 15 of the FCC rules as a Class B digital device. Each product marketed is identical to the representative unit tested and found to be compliant with the standards. Records maintained continue to reflect the equipment being produced can be expected to be within the variation accepted, due to quantity production and testing on the statistical basis as required by 47CFR §2.909. Operation is subject to the following two conditions: (1) This device may not cause harmful interference, and (2) This device must accept any interference received, including interference that may cause undesired operation. The above named party is responsible for ensuring that the equipment complies with the standards of 47CFR §15.101 to §15.109.

Product Name: Digital Single Lens Camera

Model Number: Q10

Contact person: Customer Service Manager

Date and Place: September, 2012, Colorado

Information for Users on Collection and Disposal of Old Equipment and Used Batteries



1. In the European Union

These symbols on the products, packaging and/or accompanying documents mean that used electrical and electronic equipment and batteries should not be mixed with general household waste.

Used electrical/electronic equipment and batteries must be treated separately and in accordance with legislation that requires proper treatment, recovery and recycling of these products.



By disposing of these products correctly you will help ensure that the waste undergoes the necessary treatment, recovery and recycling and thus prevent potential negative effects on the environment and human health which could otherwise arise due to inappropriate waste handling.

If a chemical symbol is added beneath the symbol shown above, in accordance with the Battery Directive, this indicates that a heavy metal (Hg = Mercury, Cd = Cadmium, Pb = Lead) is present in the battery at a concentration above an applicable threshold specified in the Battery Directive.

For more information about collection and recycling of used products, please contact your local authorities, your waste disposal service or the point of sale where you purchased the products.

2. In other countries outside the EU

These symbols are only valid in the European Union. If you wish to discard used products, please contact your local authorities or dealer and ask for the correct method of disposal.

For Switzerland: Used electrical/electronic equipment can be returned free of charge to the dealer, even when you don't purchase a new product. Further collection facilities are listed on the home page of www.swico.ch or www.sens.ch.

Memo

PENTAX RICOH IMAGING CO., LTD.

2-35-7, Maeno-cho, Itabashi-ku, Tokyo 174-8639, JAPAN
(<http://www.pentax.jp>)

**PENTAX RICOH IMAGING
FRANCE S.A.S.
(European Headquarters)**

112 Quai de Bezons, B.P. 204, 95106 Argenteuil Cedex,
FRANCE
(HQ - <http://www.pentax.eu>)
(France - <http://www.pentax.fr>)

**PENTAX RICOH IMAGING
DEUTSCHLAND GmbH**

Julius-Vosseler-Strasse 104, 22527 Hamburg, GERMANY
(<http://www.pentax.de>)

**PENTAX RICOH IMAGING
UK LTD.**

PENTAX House, Heron Drive, Langley, Slough, Berks
SL3 8PN, U.K.
(<http://www.pentax.co.uk>)

**PENTAX RICOH IMAGING
AMERICAS CORPORATION**

633 17th Street, Suite 2600, Denver, Colorado 80202, U.S.A.
(<http://www.pentaximaging.com>)

**PENTAX RICOH IMAGING
CANADA INC.**

1770 Argentia Road Mississauga, Ontario L5N 3S7, CANADA
(<http://www.pentax.ca>)

**PENTAX RICOH IMAGING
CHINA CO., LTD.**

23D, Jun Yao International Plaza, 789 Zhaojabang Road,
Xu Hui District, Shanghai, 200032, CHINA
(<http://www.pentax.com.cn>)

- Specifications and external dimensions are subject to change without notice.