

STAGE PIANO

Owner's Manual

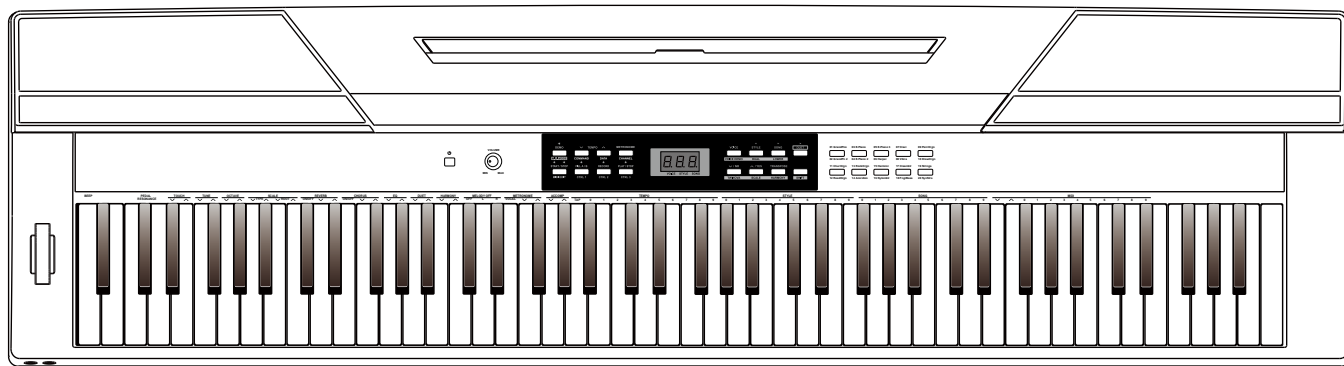

INFORMATION FOR YOUR SAFETY!

THE FCC REGULATION WARNING (for USA)

This equipment has been tested and found to comply with the limits for a Class B digital device, pursuant to Part 15 of the FCC Rules.

These limits are designed to provide reasonable protection against harmful interference in a residential installation. This equipment generates, uses, and can radiate radio frequency energy and, if not installed and used in accordance with the instructions, may cause harmful interference to radio communications. However, there is no guarantee that interference will not occur in a particular installation. If this equipment does cause harmful interference to radio or television reception, which can be determined by turning the equipment off and on, the user is encouraged to try to correct the interference by one or more of the following measures:

- Reorient or relocate the receiving antenna.
- Increase the separation between the equipment and receiver.
- Connect the equipment into an outlet on a circuit different from that to which the receiver is connected.
- Consult the dealer or an experienced radio/TV technician for help.

Unauthorized changes or modification to this system can void the user's authority to operate this equipment.

CAUTION

The normal function of the product may be disturbed by Strong Electro Magnetic Interference. If so, simply reset the product to resume normal operation by following the owner's manual. In case the function could not resume, please use the product in other location.

PRECAUTIONS

PLEASE READ CAREFULLY BEFORE PROCEEDING

Please keep this manual in a safe place for future reference.

Power Supply

Please connect the designated AC adaptor to an AC outlet of the correct voltage.

Do not connect it to an AC outlet of voltage other than that for which your instrument is intended.

Unplug the AC power adaptor when not using the instrument, or during electrical storms.

Connections

Before connecting the instrument to other devices, turn off the power to all units. This will help prevent malfunction and / or damage to other devices.

Location

Do not expose the instrument to the following conditions to avoid deformation, discoloration, or more serious damage:

Direct sunlight
 Extreme temperature or humidity
 Excessive dusty or dirty location
 Strong vibrations or shocks
 Close to magnetic fields

Interference with other electrical devices

Radios and televisions placed nearby may experience reception interference. Operate this unit at a suitable distance from radios and televisions.

Cleaning

Clean only with a soft, dry cloth.
 Do not use paint thinners, solvents, cleaning fluids, or chemical-impregnated wiping cloths.

Handling

Do not apply excessive force to the switches or controls.

Do not let paper, metallic, or other objects into the instrument. If this happens, remove the electric plug from the outlet. Then have the instrument inspected by qualified service personnel.

Disconnect all cables before moving the instrument.

Contents

Panel Description

Front Panel.....	4
Rear Panel.....	5

Setup

Setting a Music Stand.....	6
Power Supply.....	6

Connections

Connecting a pair of Headphones.....	7
Connecting an Audio Equipment.....	7
Connecting a MP3/CD Player.....	7
Connecting a Computer and an MIDI Device.....	7
Connecting a Footswitch.....	8
Connecting a Unit Pedal.....	8

Quick Start

Power Switch and Master Volume.....	9
Playing Demo Songs.....	9
Playing Voices.....	9
Playing Styles.....	9
Playing Songs.....	10
Record.....	10

Advanced Use

Playing Voices.....	11
Select and play Upper Voice.....	11
Playing two Voices Simultaneously.....	11
Playing Different Voices with Both Hands.....	11
Playing Voice Demo.....	12
Touch Sensitivity.....	12
Transpose.....	12
Tune.....	13
Pedal Resonance.....	13
Metronome.....	13

Playing Accompaniment

Selecting a Style.....	14
Start/Stop Style Playing.....	14
Fill In A/B.....	14
Accompaniment Volume.....	14
Tempo.....	15

DSP Effect

Reverb.....	16
Chorus.....	16
EQ.....	16

Listening to the songs

Playing Songs.....	17
Stop Playing Songs.....	17
Learning Songs.....	17

Record

Prepare Recording.....	18
Start Recording.....	18
Stop Recording.....	18
Play Back the User Song.....	18
Delete the User Song.....	19

Duet.....

Harmony.....

Scale.....

TWINOVA.....

Beep Tone.....

MIDI Function

What's MIDI?.....	22
MIDI Terminals.....	22
MIDI Controller.....	22
Controller Settings.....	22
Controller Output.....	24

Restore Factory Setting.....

Troubleshooting.....

Specification.....

Appendix

Voice List.....	26
Style List.....	27
Song List.....	28
Demo List.....	29
MIDI Implementation Chart.....	30

Scale Tuning System.....

Panel Description

Front Panel

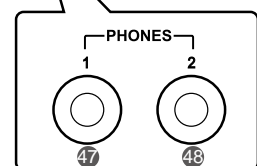
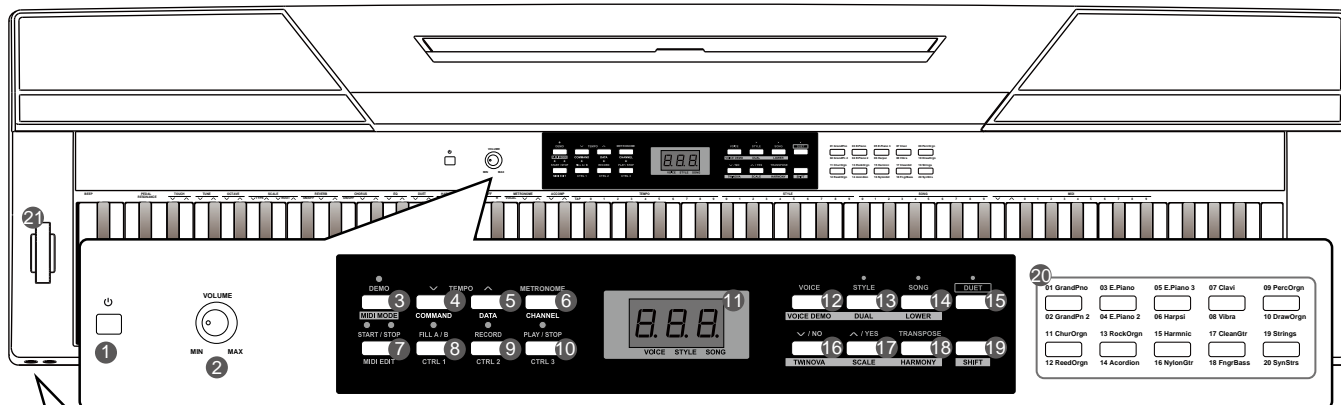

1. [POWER] Switch

Turn the power on or off.

2. [VOLUME] Knob

Adjust the master volume.

3. [DEMO]/[MIDI MODE] Button

Start/Stop demo playback.
Press and hold [shift], then press [MIDI MODE] to turn MIDI MODE on or off.

11. The NIXIE TUBE Display

Display all the parameters and values related to the currently selected operation and mode of the piano.

15. [DUET] Button

Turn the duet function on or off.

19. [SHIFT] Button

Press and hold [SHIFT], then press other button enables you to execute various commands.

20. VOICE DIRECT SELECT Buttons

Quickly select a preset voice.

21. [PITCH BEND] Wheel

Roll the wheel upward or downward to raise or lower the pitch variations.

47-48. PHONE 1 and PHONE 2

Connect stereo headphones with a 1/4" stereo phone plug.

When enter the MIDI controller mode :

4. [TEMPO -] Button

Decrease the tempo value.

5. [TEMPO +] Button

Increase the tempo value.

6. [METRONOME] Button

Turn the metronome on or off.

7. [START/STOP] Button

Start or Stop playing the song or style.

8. [FILL A/B] Button

Fill in variation A/ B section.

9. [RECORD] button

Enter the record mode.

10. [PLAY/STOP] Button

Start or Stop playing back recorded song.

When the [SHIFT] button is released :

12. [VOICE] Button

Switch to voice mode.

13. [STYLE] Button

Switch to style mode.

14. [SONG] Button

Enter the song mode.

16. [-/NO] Button

Decrease the parameter value or execute "NO" operation.

17. [+ /YES] Button

Increase the parameter value or execute "YES" operation.

18. [TRANPOSE] Button

Enter the transpose setting.

When exit the MIDI controller mode :

4. [COMMAND] Button

Switch to command edit mode.

5. [DATA] Button

Switch to value edit mode.

6. [CHANNEL] Button

Switch to channel edit mode.

7. [MIDI EDIT] Button

Enter or Exit MIDI controller edit mode.

8. [CTRL 1] Button

Transmit controller 1 data, or switch to controller 1 edit mode.

9. [CTRL 2] Button

Transmit controller 2 data, or switch to controller 2 edit mode.

10. [CTRL 3] Button

Transmit controller 3 data, or switch to controller 3 edit mode.

When the [SHIFT] button is pressed :

12. [VOICE DEMO] Button

Start or Stop playing voice demo.

13. [DUAL] Button

Turn the dual function on or off.

14. [LOWER] Button

Turn the lower function on or off.

16. [TWINOVA] Button

Turn the TWINOVA function on or off.

17. [SCALE] Button

Turn the scale function on or off.

18. [HARMONY] Button

Turn the harmony function on or off.

Panel Description

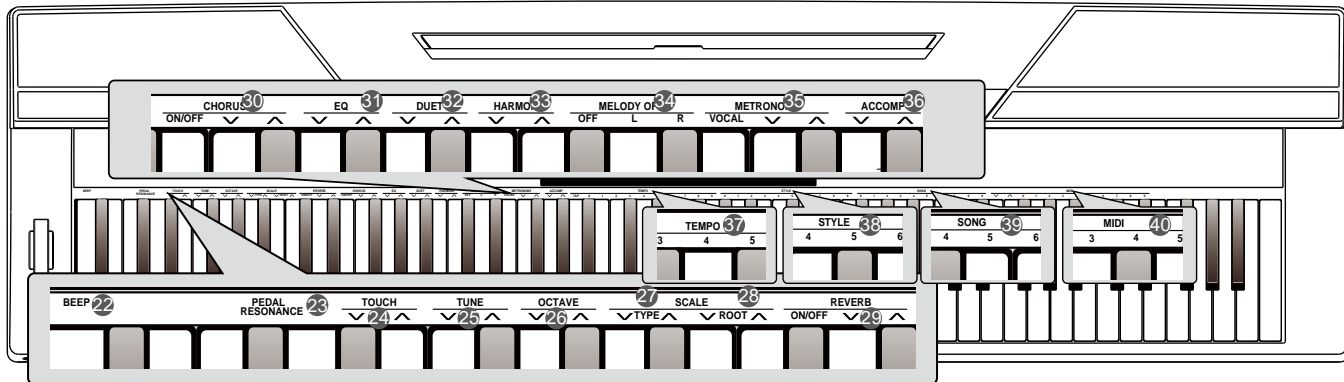

When the [SHIFT] button is pressed:

- 22. [BEEP] Key**
Turn the prompt tone on or off.
- 23. [PEDAL RESONANCE] Key**
Turn the pedal resonance on or off.
- 24. [TOUCH] Keys**
Set an appropriate touch sensitivity level.
- 25. [TUNE] Keys**
Adjust the tune value.
- 26. [OCTAVE] Keys**
In TWINOVA mode, adjust the octave value.
- 27. [SCALE TYPE] Keys**
In SCALE mode, select different scale types.
- 28. [SCALE ROOT] Keys**
In SCALE mode, set the root note of scale.
- 29. [REVERB] Keys**
Turn the reverb effect on/off, or select the desired reverb effect type.
- 30. [CHORUS] Keys**
Turn the chorus effect on/off, or select the desired chorus effect type.
- 31. [EQ] Keys**
Select the desired EQ effect type.
- 32. [DUET] Keys**
Select the desired duet effect type.
- 33. [HARMONY] Keys**
Select the desired harmony effect type.
- 34. [MELODY OFF] Keys**
In the SONG mode, press "L"/"R" to mute/activate left or right-hand part, allowing each part to be practiced separately.

When the [SHIFT] button is pressed:

- 35. [METRONOME] Keys**
Set the metronome type.
- 36. [ACCOMP VOLUME] Keys**
Set the accompaniment volume value.
- 37. [TEMPO] Keys**
Set the tempo value.
- 38. [STYLE] Keys**
Select the desired style.
- 39. [SONG] Keys**
Select the desired song.

In the MIDI controller edit mode:

- 40. [MIDI] Keys**
In the MIDI edit mode, set parameter value which related to MIDI controllers.

Rear Panel

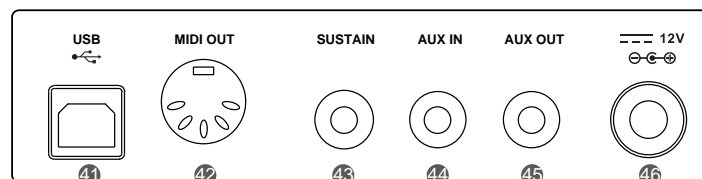

- 41. USB Terminal**
Connect to a computer.
- 42. MIDI OUT Jack**
Connect an external MIDI IN device.
- 43. SUSTAIN Jack**
Connect a sustain pedal.
- 44. AUX IN Jack**
Connect any external audio source, such as an MP3 or CD player.
- 45. AUX OUT Jack**
Connect an audio equipment.
- 46. DC 12V**
Connect DC 12V power adaptor.

Setup

This section contains information about setting up your instrument and preparing to play. Please go through this section carefully before turning the power on.

Setting a Music Stand

Follow the images on the right, and install the music stand correctly. A music stand is supplied with the keyboard. You can easily attach it to the instrument by inserting it into the slots at the rear of the panel.

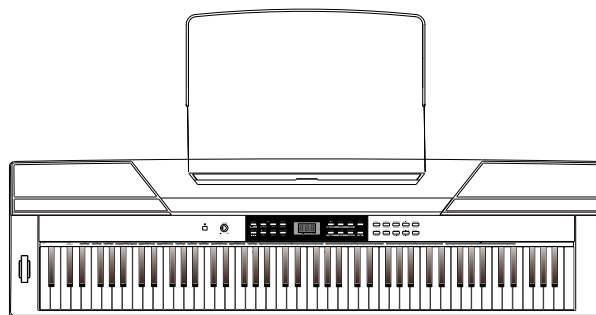

Power Supply

1. Make sure that the piano is turned off. Before you switch your piano on or off, turn down the volume of piano and any connected audio equipments first.
2. Connect the AC adaptor to the power supply jack of this piano.
3. Plug the AC adaptor into an AC outlet.
4. Press the POWER switch, the nixie tube displays "0.01", which indicates the piano is power on.
5. If you are ready to turn off the piano, please long press the POWER switch.

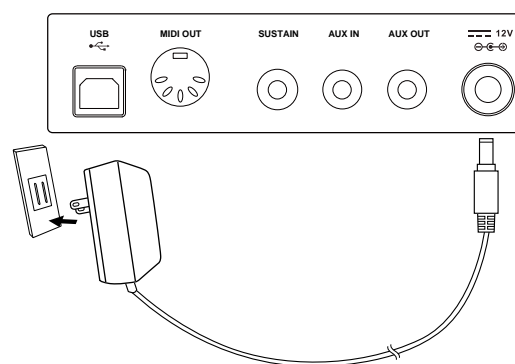
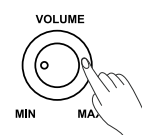

Note:

1. In order to save energy, we have designed the "Automatic Shutdown" function to the piano. With this function, the keyboard will automatically shutdown in 30 minutes later if you do not take any action on the piano. If you don't need this feature, just press and hold the [A0] key (the 1st key) and turn it on.
2. When the piano is not in use or during thunderstorm, please disconnect the power for safety purpose.

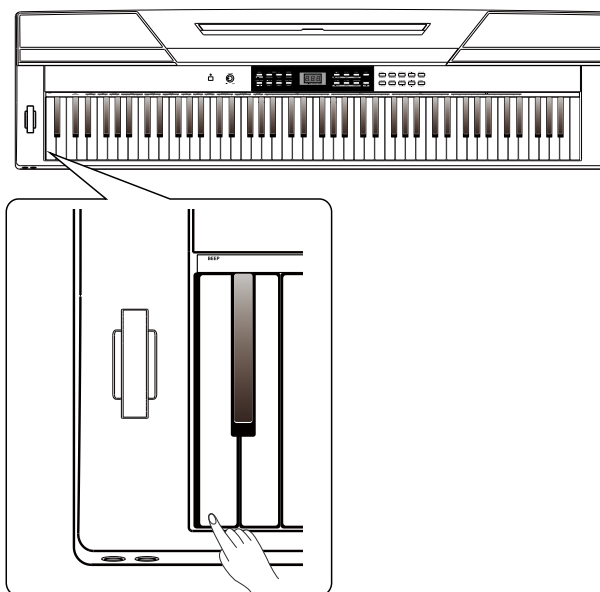

Connections

Connecting a pair of Headphones

A standard pair of stereo headphones can be plugged in here for private practice or late-night playing.

Jack1: When a pair of headphones is plugged into the jack 1, the sound can be heard from both headphones and speakers of the instrument.

Jack2: When a pair of headphones is plugged into the jack 2, the internal stereo speaker system is automatically shut off. The sound can only be heard from headphones.

Note:

To avoid the risk of hearing loss when using headphones, please do not play the piano with a high volume level for a long time.

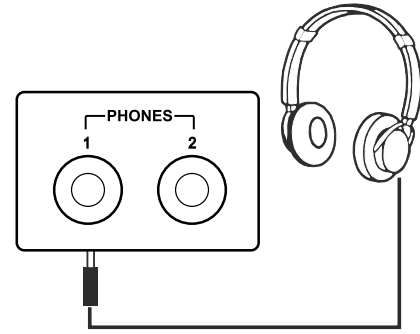

Connecting an Audio Equipment

The rear-panel AUX OUT jack delivers the output of the instrument for connection to a keyboard amplifier, stereo sound system, a mixing console, or tape recorder.

Use an audio cable to plug into the AUX OUT jack located on the rear board, then plug the other end of the cord into AUX IN of the amplifier.

Note:

To avoid damaging the speakers, please ensure that the volume has been set to the minimum level before connecting the power and other devices.

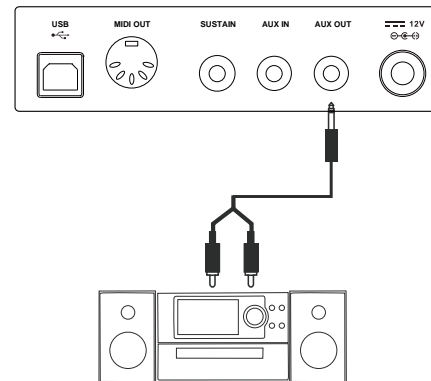

Connecting a MP3/CD Player

Connect the audio output of an MP3/CD player or other audio Source to the stereo AUX IN jack on the rear panel.

The input signal is mixed with the piano signal, allowing you to play along.

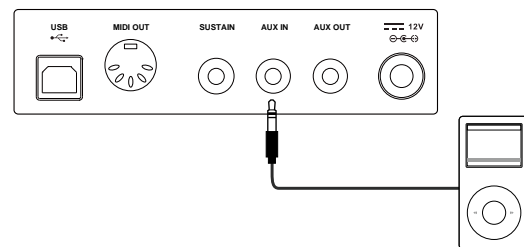

Connecting a Computer and an MIDI Device

MIDI OUT Connector

Connect the instrument MIDI OUT terminal to the external device MIDI IN terminal via the MIDI cables. MIDI messages generated by the instrument will be transmitted to another MIDI device. Now this instrument will be used as MIDI Controller.

USB Connector

By connecting a PC to the [USB] terminal, you can transfer data between the instrument and the computer via USB cables.

For example, you can save your instrument performance data on the computer and playback your MIDI file from computer through piano.

Note:

Do not set the USB audio to be input and output simultaneously when you are setting the software on the computer. Otherwise the sound will be overlapped when play the keyboard.

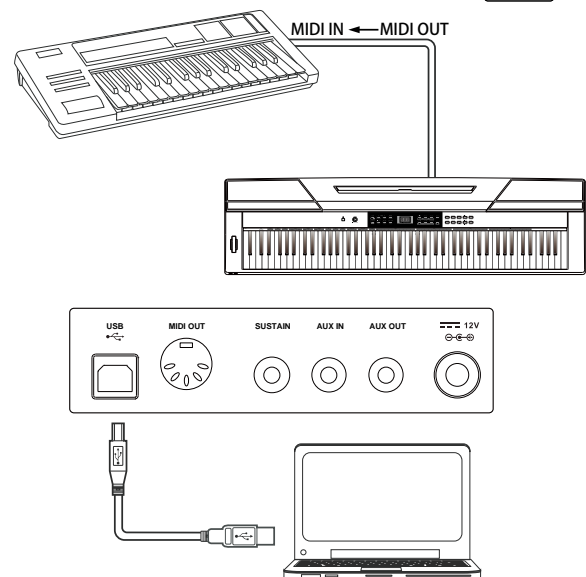

Connections

Connecting a Footswitch

An optional footswitch can be plugged into the sustain jack and be used to switch sustain on or off. Simply by pressing a sustain footswitch, you will have a natural sustain as you play.

Note:

1. This instrument supports not only the foot switch we supply, but also those with other brands.
2. Make sure the power is off when connecting the pedal with other brand, otherwise the sequence of switch on/off will be reversed when turning the piano on.

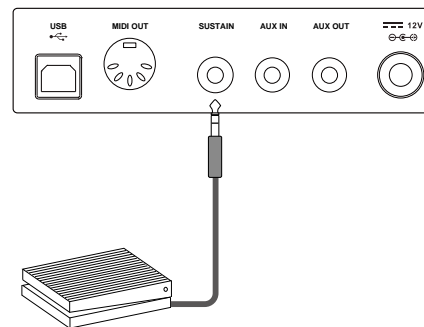

Connecting a Unit Pedal

To simulate the real piano, you can also connect a unit pedal to the unit pedal jack on the bottom cover, then it contains three functional pedals: Sustain, Sostenuto, Soft.

Sustain Pedal

When the sustain pedal is pressed, notes sustain longer. Releasing the pedal immediately stops any sustained notes.

It also supports the half-pedal operation, which makes your sustain effect more smooth and real when you are performing.

Sostenuto Pedal

When the sostenuto pedal is pressed, the notes played before you step on the pedal would have a sustain effect.

Soft Pedal

When the soft pedal is pressed, all notes played on the keyboard will have a softer effect.

Note:

The unit pedal needs to be purchased separately.

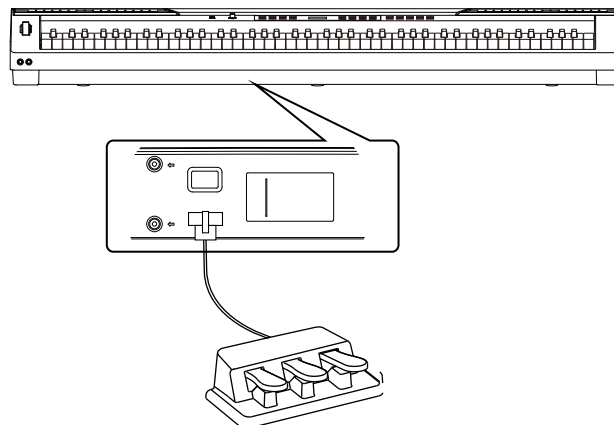

Quick Start

Power Switch and Master Volume

Turn the Power On/Off

1. First, please ensure the correct connection has been made based on the previous instruction.
2. Press POWER switch, the nixie tube screen lights up, and displays "0.01", it indicates the instrument is power on.

Note:

Press the POWER switch, if the nixie tube screen dose not appear, please check the power supply jack connection are made correctly or not.

Adjust the Master Volume

Rotate the [VOLUME] knob clockwise, the volume increases and vice versa.

Note:

If the keyboard is in silent, that means the volume may has been adjusted to its minimum level or the headphone jack has been connected.



Playing Demo Songs

This instrument features 2 wonderful demo songs, please refer to the Demo list for details

1. Press the [DEMO] button, the nixie tube displays "d-1", meanwhile, all demo songs start to play in a continuous loop.
2. Press the [+ / YES] / [- / NO] button to select the desired demo song.
3. Press the [DEMO] or [START / STOP] button to stop playing, and exit demo mode.

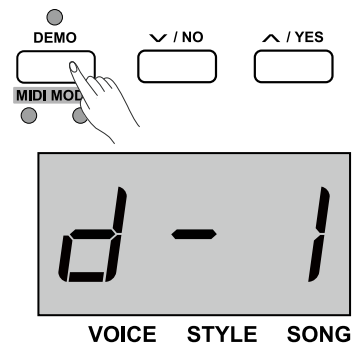

Playing Voices

This instrument features exceptionally realistic 20 voices, please refer to the Voice list for details.

1. Press the [VOICE] button.
Enter the voice mode. The nixie tube displays the current voice number, such as "0.01".
2. Select a voice.
Press the [+ / YES] / [- / NO] button to select a voice you want to play. You can also use the voice direct button to select one.
3. Play the voice.
You can play the keyboard and listen to the wonderful voice.

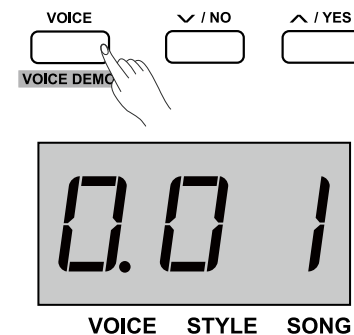

Playing Styles

This instrument features 50 piano styles in a variety of different musical genres. Try selecting some of the different styles (Refer to the Style List) and play with the auto accompaniment.

1. Press the [STYLE] button.
Enter the style mode. The nixie tube displays the current style number, such as "0.01".
2. Select a style.
Press the [+ / YES] / [- / NO] button to select a style you want to play. You can also press and hold the [SHIFT] button, then press the style keys marked STYLE 0-9 to select the desired style.

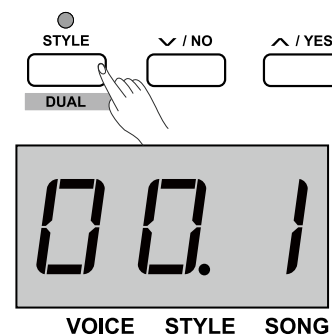

Quick Start

3. Play the style.

Press the [START/STOP] button and its relevant LED indicators are flashing in red and green. As soon as you play the keyboard with your left-hand, the auto accompaniment (piano style) starts.

Note:

If you press key(s) marked STYLE 0-9 to select the desired style, please press and hold the [shift] button, then tapping 2 consecutive digits. For example, tapping 0,8 in sequence to select the 08 style.



Playing Songs

This instrument features 60 preset songs, please refer to the Song list.

1. Press the [SONG] button.

Enter the song selection mode. The nixie tube displays the current song number, and it will play all songs circularly.

2. Select a song.

Press the [+ / YES] / [- / NO] button to select a song you want to play. You can also press and hold the [SHIFT] button, then press the song keys marked SONG 0-9 to select the desired song.

3. Play the song.

Press the [START / STOP] button to play the selected song in a continuous loop.

4. When the selected song has finished, press [VOICE] / [STYLE] button can exit the song mode.

Note:

If you press key(s) marked SONG 0-9 to select the desired song, please press and hold the [shift] button, then tapping 2 consecutive digits. For example, tapping 0,8 in sequence to select the 08 song.

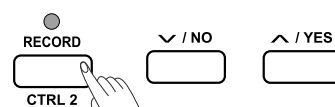
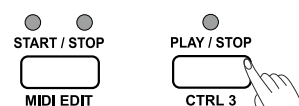
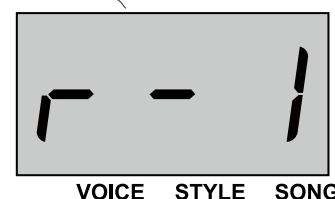
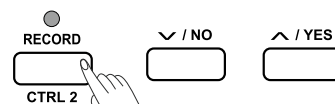
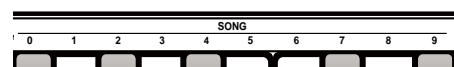
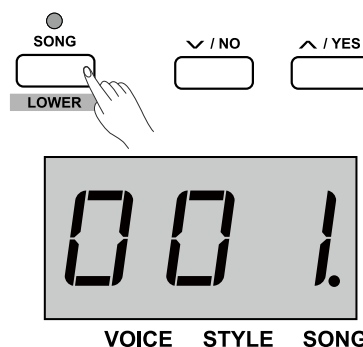

Record

This stage piano allows up to 5 user songs to be recorded.

1. Press the [RECORD] button to enter user song memory selection, the nixie tube displays current user song number. Press the [+ / YES] / [- / NO] button to select desired user song memory to be saved.

2. Press the [RECORD] button again, enter recording standby mode, the LED indicator of [START / STOP] button will be flashing. Then you can select desired voice, style or other parameters to prepare recording.

3. Press the [START/STOP] button or play a key on the keyboard to start recording. Meanwhile, the LED indicator of [RECORD] button lights up.

4. Press the [RECORD] button again to exit the record mode. The LED indicator of [RECORD] button will turn off.

5. If you want to play back the user song, you can press the [PLAY/STOP] button to enter the selection interface. And press the [+ / YES] / [- / NO] button to select the user song. Then press the [PLAY/STOP] button again to play back user song.

6. While playing back recorded songs, you can press the [PLAY/STOP] button to exit.

7. In the user song selection interface, press the [RECORD] button, the nixie tube displays "dEL", which means enter the delete interface. Then press [+ / YES] to confirm delete the user song, or press [- / NO] to cancel this operation and go back to the selection interface.

Advanced Use

Playing Voices

This instrument features 20 exceptionally realistic voices. Please refer to the Voice List for details. The default upper voice number is 001.

Select and play Upper Voice

1. Press the [VOICE] button or voice direct button to select a voice you want to play. The "VOICE" icon on the nixie tube lights up, and also indicates the current upper voice number, such as "0.01".
2. Select a voice.
Press the [+ / YES] / [- / NO] button or voice direct button to select the upper voice you want to play.
3. Play the voice.
You can play the keyboard and listen to the wonderful voice.

Note:

If the dual or lower function is on, repeatedly press the [VOICE] button to switch between UPPER and DUAL/LOWER voice. The nixie tube also indicates the current voice number.

01 GrandPno	03 E.Piano	05 E.Piano 3	07 Clavi	09 PercOrgn
02 GrandPn 2	04 E.Piano 2	06 Harpsi	08 Vibra	10 DrawOrgn
11 ChurOrgn	13 RockOrgn	15 Harmnic	17 CleanGtr	19 Strings
12 ReedOrgn	14 Acordion	16 NylonGtr	18 FngrBass	20 SynStrs

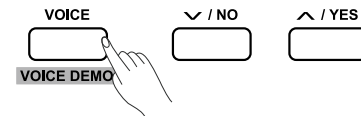

VOICE STYLE SONG

Playing two Voices Simultaneously

This stage piano has a dual voice function. This function allows two sounds to be layered together, creating a more complex sound. The default dual voice number is "d.19".

1. Select the upper voice you want to play.
2. Press and hold the [SHIFT] button, then press the [DUAL] button to turn the dual function on. The LED indicator of [DUAL] button lights up, meanwhile, the nixie tube displays the dual voice number: "d.19".
3. Press the [+ / YES] / [- / NO] button or voice direct button to select the dual voice you want to play.
4. Play the keyboard, and then you will hear two different voices to be layered together. It seems like two different instruments are playing at the same time.
5. Press and hold the [SHIFT] button, then press the [DUAL] button again will turn the dual function off.

Note:

While the keyboard has been split, only the right hand area can respond to the dual voice, the left hand area cannot respond to it.

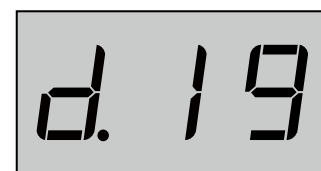
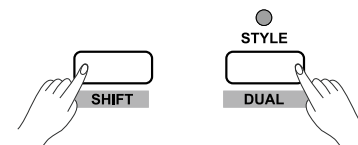

VOICE STYLE SONG

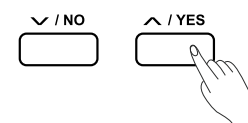

Playing Different Voices with Both Hands

The lower function splits the keyboard into right and left areas to create two different voices. The left section voice is lower voice. You can assign a desired split point on the keyboard. The default lower voice number is L.19.

1. Select the upper voice you want to play on the right of the split point.
2. Press and hold the [SHIFT] button, then press the [LOWER] button to turn lower function on. The LED indicator of [LOWER] button lights up, meanwhile, the nixie tube displays the lower voice number: "L.19".
3. You can press the [+ / YES] / [- / NO] button or voice direct button to select the lower voice you want to play.
4. Play the keyboard.
You can hear the right and left hand area with different voices.
5. Press and hold the [SHIFT] button, then press the [LOWER] button again will turn lower function off.

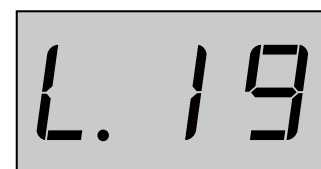
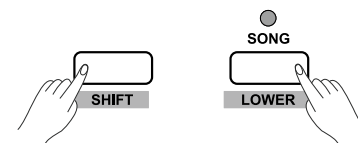

VOICE STYLE SONG

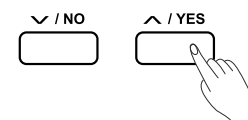

Advanced Use

Split Point:

The point on the keyboard that separates UPPER or DUAL voice and LOWER voice is called "split point".

The default split point is: F#3 (34) .

1. Press and hold the [LOWER] button, then press any key to set split point.
2. Release the [LOWER] button, and automatically exit the split point setting.

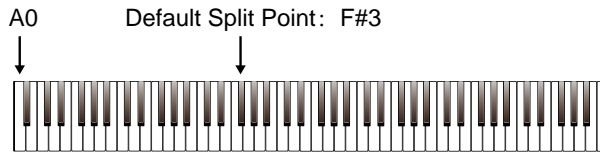

Playing Voice Demo

1. In voice mode, press and hold the [SHIFT] button, then press the [VOICE DEMO] button to start playing back voice demo. While the voice demo is playing, you can repeat above operations to exit voice demo mode.
2. Press the [START/ STOP] button to stop playing voice demo mode.

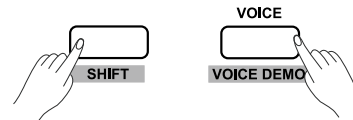

Touch Sensitivity

The keyboard is equipped with a touch response feature that lets you dynamically and expressively control the level of the voice with your playing strength – just as on an acoustic instrument. That means the harder you play the keys, the greater volume comes from the speakers with fixed master volume. Turn this function off results in a fixed touch response, or no level change no matter how hard or how soft you play the keys. There are 3 types of touch setting for this instrument (Off, 1-3), the default setting is: "2".

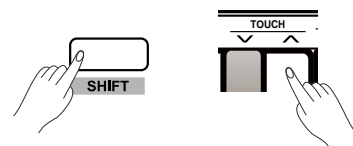

Operation:

Press and hold the [SHIFT] button, then press the key which represents touch +/- to select an appropriate touch level.

Parameters	Description
OFF	Fixed
1	Soft
2	Medium
3	Hard

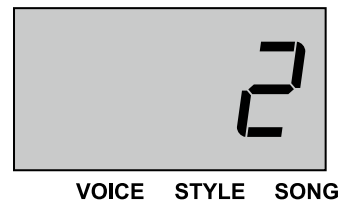

Transpose

This function allows the overall pitch of the instrument to be transposed up or down by a maximum of one octave in semitone increments.

For example, you have to play a song in G key which you are not familiar with. So please set the transpose value to be -05 or 07, then you can easily play this song with C key.

Operation:

1. Press the [TRANSPOSE] button, the nixie tube displays current transpose value, such as "07". Press the [+ / YES] / [- / NO] button to set transpose value, the entire keyboard pitch will be changed.
2. Press the [+ / YES] and [- / NO] buttons simultaneously to recover the default value: "0".

Parameters	Description
Transpose +	Increase entire keyboard pitch in semitone step.
Transpose -	Decrease entire keyboard pitch in semitone step.

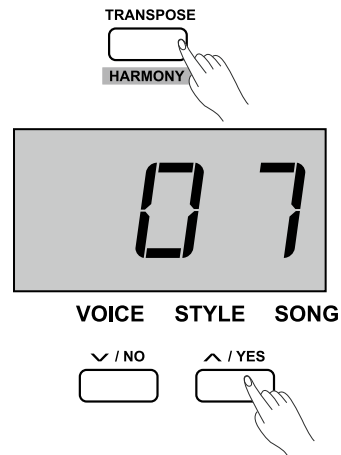

Advanced Use

Tune

The overall tuning of the instrument can be shifted up or down by a maximum of 100 cents in 1-cent increments (100 cents = 1 semitone).

Operation:

1. Press and hold the [SHIFT] button, then press the key marked TUNE +/- to set the tune value. The nixie tube currently displays tune value.
2. Press the [TUNE +] and [TUNE -] keys simultaneously to recover default tune value: "00".

Parameters	Description
Tune +	Increase entire keyboard pitch in 1 step.
Tune -	Decrease entire keyboard pitch in 1 step.

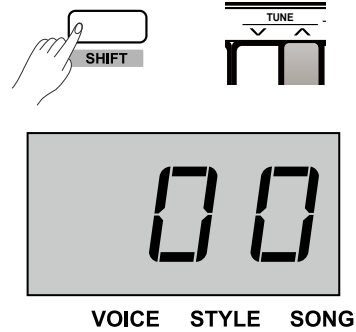

Pedal Resonance

Pedal resonance, is a function to simulate the reverberation of notes when pressing the sustain pedal on an actual grand piano. With pedal resonance, it reproduces the rich harmonics and unique sound characteristics of an actual grand piano when using the sustain pedal.

1. Press and hold the [SHIFT] button, then press the [PEDAL RESONANCE] key to turn this function on.
2. The default setting of pedal resonance is: "off", please turn it on if necessary.

Note:

1. The harmony function is automatically turned off when you set PEDAL RESONANCE on.
2. It may cause a slight sound paused or noise if you switch pedal resonance on/ off while you are performing. This is normal phenomenon to shift function between on and off.



Metronome

The Metronome function provides a steady beat to aid practicing the piano at a consistent tempo.

1. Turn the metronome on/ off
Press the [METRONOME] button to turn metronome function on or off. When metronome is in use, the LED indicator of [START/ STOP] keeps flashing with current tempo. Red light represents downbeat, and green light represents upbeat. The tempo of the metronome can be freely adjusted. Please refer to "TEMPO" setting for details.
2. Change the metronome time signature
Press and hold the [SHIFT] button, then press the key marked METRONOME +/- to set time signature. The nixie tube currently displays the number of beat type, such as: "4". There are 9 time signatures can be set: 0, 2-9.
3. Select metronome sound
Press and hold the [SHIFT] button, then press the key marked VOCAL to change metronome sound: normal sound and human voice.

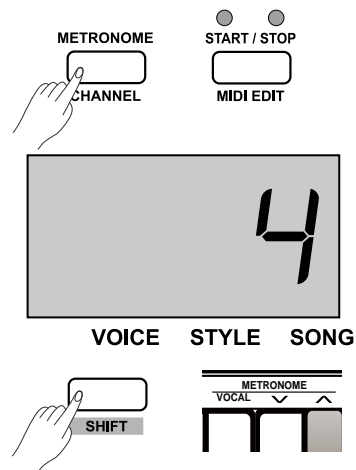

Note:

The metronome function is invalid in SONG mode.

Playing Accompaniment

This stage piano features 50 piano accompaniments. Please refer to the style list for details. The default style number is: "00.1"

Selecting a Style

1. Press [STYLE] button to enter style mode.
The nixie tube displays the current style number, such as "00.1".
2. Press the [+ / YES] [- / NO] button to select the desired style, or you can press and hold the [SHIFT] button, then press the style keys marked 0-9 to select the desired style.

Note:

If you press key(s) marked STYLE 0-9 to select the desired style, please press and hold the [shift] button, then tapping 2 consecutive digits. For example, tapping 0,8 in sequence to select the 08 style.

Start/Stop Style Playing

1. In the style mode, press the [START / STOP] button to enter standby mode, the "auto bass chord"(A.B.C) function is automatically turned on, meanwhile its indicators (red & green) are flashing. Then play chords on the chord section with left hand, the style starts playing immediately.
2. Press the [START / STOP] button again to stop playing the style, at the mean time, the A.B.C. is automatically turned off.

Fill In A/B

1. As the system default of selected accompaniment is the main A section of music (the LED indicator lights up), so when the accompaniment function is in use, pressing the [FILL A / B] button plays an appropriate fill-in pattern to spice up the rhythm (the LED indicator flashes). When the fill-in is complete, it leads smoothly into the main B section, and the LED indicator goes out.
2. If you are playing the main B section of music (LED indicator goes out), pressing the [FILL A / B] button plays an appropriate fill-in pattern to spice up the rhythm (the LED indicator flashes). When the fill-in is complete, it leads smoothly into the main A section, and the LED indicator lights up.
3. If you press and hold the [FILL A / B] button, it plays the fill-in pattern circularly, the LED indicator keeps flashing.

Accompaniment Volume

This function is used to change the volume of all tracks of accompaniment for balancing the volume between accompaniment part and keyboard voice.

1. Press and hold the [SHIFT] button, then use the [ACCOMP +] / [ACCOMP -] key to set accompaniment volume, adjustable range: 0~127.
2. Press the [ACCOMP +] and [ACCOMP -] keys simultaneously to turn off the accompaniment volume, the nixie tube displays "OFF", press the [ACCOMP +] and [ACCOMP -] keys simultaneously again to turn on the accompaniment volume.

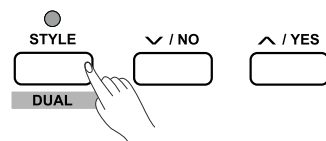

VOICE STYLE SONG

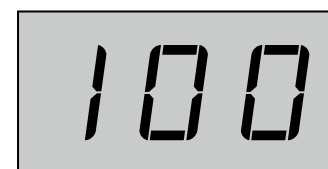
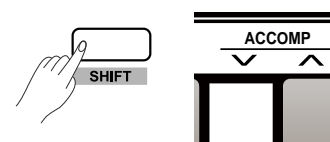
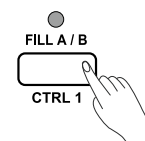
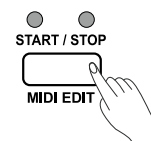

VOICE STYLE SONG

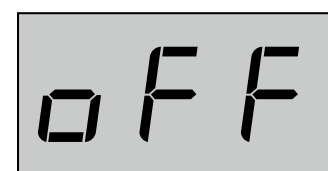

VOICE STYLE SONG

Playing Accompaniment

Tempo

Each style, song, metronome, and duet of this instrument has been programmed with a default tempo. However, this can be changed by the tempo button. Adjustable range: 30~280.

Operation:

1. Press the [TEMPO +]/ [TEMPO -] button to adjust the desired tempo value, the nixie tube displays current tempo value.
2. Press the [TEMPO +] and [TEMPO -] buttons simultaneously to restore the default optional tempo for style and song.
3. Press and hold the [SHIFT] button, then press the key(s) marked TEMPO 0-9 to set the tempo value. For example, press the 2, 1, 4 in sequence, then the tempo value will be: "214".
4. During style or song playback, press and hold the [SHIFT] button, then tapping the key marked TAP twice at the desired tempo.

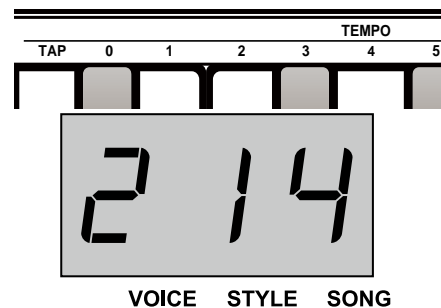
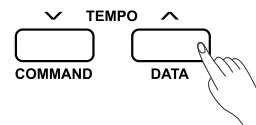

Parameters	Description
TAP	Quickly set the desired tempo value.
TEMPO +/-	Increase/ Decrease tempo value in step 1.
0 ~ 9	Directly set the specified tempo value.

Note:

1. If you press key(s) marked TEMPO 0-9 to select the desired tempo, please press and hold the [shift] button, then tapping 3 consecutive digits. For example, tapping 0,6,4 in sequence to set the tempo value 64.
2. When the style is stopped, and the times you have tapping the key marked [TAP] are same with beat count of metronome type, the system will automatically turn metronome on, and the tempo value equals to the interval of your last two taps.



DSP Effect

The DSP effect is the sound localization technology for simulating the sounds in the real environment. With DSP effect, you can add ambience and depth to your music in a variety of ways. There are 5 reverb effects, 5 chorus effects, 5 EQ effects built into this instrument.

Reverb

Press and hold the [SHIFT] button, then press the key marked ON/OFF in the REVERB section to turn reverb effect on/off. Tap the key marked REVER +/- which are next to the ON/OFF to select the desired reverb type.

The default reverb effect setting is: turn on, and reverb type is: 2 Hall.

Parameter	Reverb Type
1	Room
2	Hall
3	Church
4	Delay
5	Pan Delay

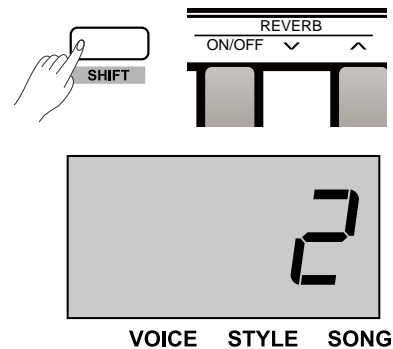

Chorus

Press and hold the [SHIFT] button, then press the key marked ON/OFF in the CHORUS section to turn chorus effect on/off. Tap the key marked CHORUS +/- which are next to the ON/OFF to select the desired chorus type.

The default chorus effect setting is: turn off, and reverb type is: 1 Chorus 1.

Parameter	Chorus Type
1	Chorus 1
2	Chorus 2
3	Chorus 3
4	Flanger
5	Rotary

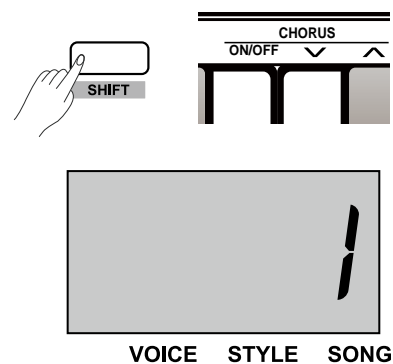

EQ

EQ function can control the gain of different frequency band. And different gain settings can make different sound field effects.

Press and hold the [SHIFT] button, then press the key marked EQ +/- to select the desired EQ type.

The default EQ type is: 1 Standard.

Parameter	EQ Type
1	Standard
2	Modern
3	Rock
4	Classic
5	Jazz

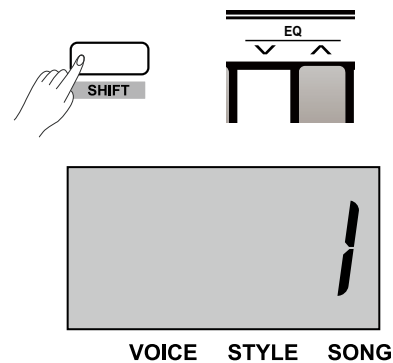

Listening to the songs

Playing Songs

This instrument has 60 preset piano songs for appreciating. Please refer to the Song List for details.

Playing songs in large cycle :

Press the [SONG] button to enter the song playing mode, the system will play all preset songs in large cycle. Meanwhile, the nixie tube displays the current song number, and the "SONG" icon lights up.

Playing songs in small cycle :

While the song is stop playing, press the [START/STOP] button to play just the song circularly.

Beat indicators :

While the song is playing, the LED indicators of [START/STOP] will keep flashing corresponding to the current tempo value: Red light represents downbeat, and green light represents upbeat.

Selecting a song :

Press [+ / YES] / [- / NO] button to select the desired song, or you can press and hold the [SHIFT] button, then press the key(s) marked SONG 0-9 to directly select a song.

Note:

If you press key(s) marked SONG 0-9 to select the desired song, please press and hold the [shift] button, then tapping 2 consecutive digits. For example, tapping 0,8 in sequence to select the 08 song.

Stop Playing Songs

While the song is playing, press the [START/STOP] button or [SONG] button to stop playing song.

Learning Songs

All preset piano songs have programmed lesson modes.

1. Press and hold the [SHIFT] button, then press the key marked [L] in MELODY OFF section. With this operation, the left-hand part of the selected song will be muted, you can practice left hand part corresponding to the right-hand part of melody.
2. In the same way, you can tap the key marked [R] to mute the right-hand part, and practice the right hand part melody.
3. Press the key marked [OFF] to exit the lesson mode. The song will recover its normal playing mode.

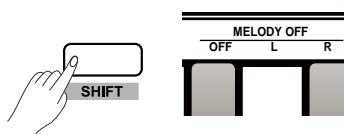
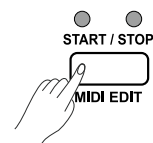
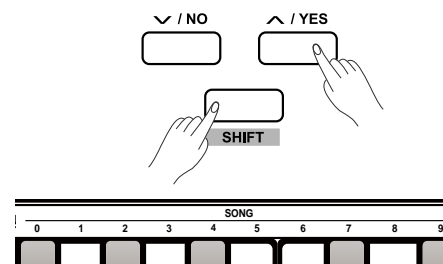
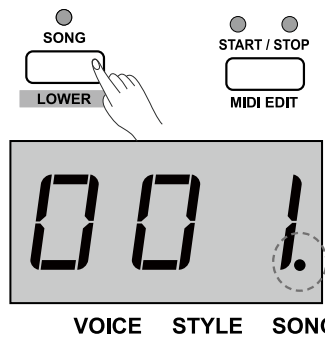

Record

With the easy-to-use song recording features, you can record your own keyboard performances as a user song. This piano allows up to 5 user songs to be recorded, stored in internal memory.

Prepare Recording

1. Before recording, firstly selecting a user song to save the recording song. Press the [RECORD] button, enter to the selection interface, the nixie tube displays current user song number: If the nixie tube displays "r-*", it means a user song has been already saved in this file. If the nixie tube displays "nF*", it means this file is new and no user song in it. Press the [+ / YES] / [- / NO] button to select the desired file to save user song.

2. Press the [RECORD] button again to enter the recording preparation status, the LED indicator of [START / STOP] button keeps flashing. So you can set the desired voice, style, tempo parameters.....

Note:

The LOWER function is automatically turned off.

Start Recording

1. Recording begins automatically as soon as you play a note on the keyboard. The LED indicator of [RECORD] button keeps lighting.

2. Press the [START/STOP] button to start recording while in the recording preparation status. And the "auto bass chord"(A.B.C) mode is automatically turned on, but the accompaniment is not playing and synchronously recorded until you play a note on the left-hand section.

Note:

If you select the "r-*" (which means there is a user song in this file) for recording, the original user song you saved will be replaced by the new data.

Stop Recording

1. Press [RECORD] again while recording can stop this action immediately. And the nixie tube displays "- - -", the system saves recording data in internal memory automatically. The indicator of recording goes out after finishing the saving operation.

2. When recording is in process, if the memory is full, the recording will stop and be saved in internal memory automatically. And the nixie tube displays "FUL", The indicator of recording goes out after finishing the saving operation.

Play Back the User Song

1. Press [PLAY/STOP] button, enter the records playback mode. If this user song you selected contains no data, the nixie tube displays "nF*", such as "nF3"; if this user song you selected contains available data, the nixie tube displays the number of user song "P-*", such as "P-2".

2. Press the [+ / YES] / [- / NO] button to select a user song.

3. Press the [PLAY / STOP] button to play your selected user song. The LED indicator of the [PLAY / STOP] button will light up.

4. In user song playing status, press the [PLAY / STOP] button again to stop playing. The LED indicator of [PLAY / STOP] button goes out.

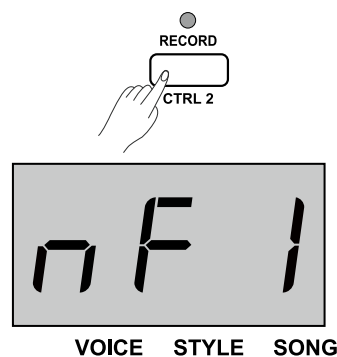

VOICE STYLE SONG

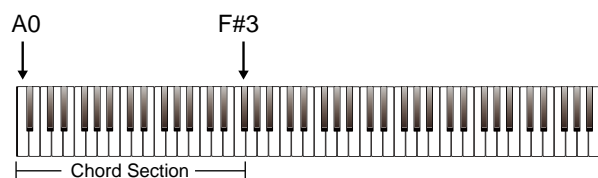
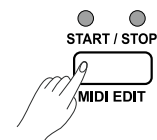

Chord Section

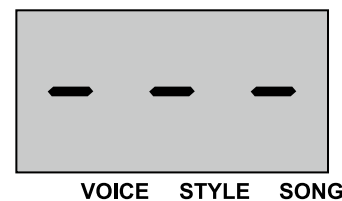
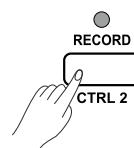

VOICE STYLE SONG



VOICE STYLE SONG

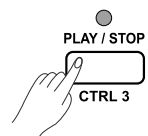

VOICE STYLE SONG

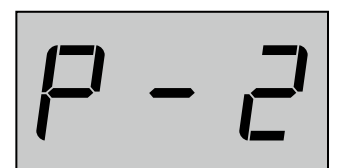

VOICE STYLE SONG

Record

Delete the User Song

1. Pressing and holding [RECORD] and [PLAY/ STOP] button together and turn power on simultaneously, all user songs will be erased.
2. Press the [PLAY/ STOP] button to enter the status of selecting user song, then press the [RECORD] button to delete the selected user song, and the nixie tube displays "dEL". Press the [+ / YES] button to confirm the delete operation; press the [- / NO] button to cancel the delete operation and go back to playback selection interface.

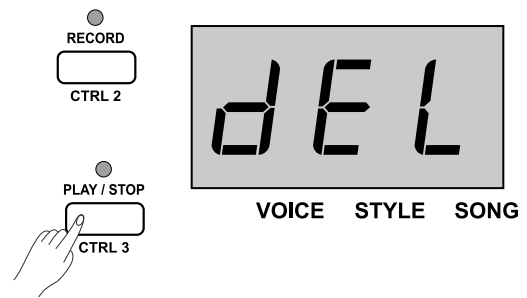

Note:

We have programmed power-off protection, all data of user songs won't be erased even the instrument is powered off.

Duet

Duet is a functional feature, which can produce the dynamic elements of a professional-sounding arrangement in your performance. You can achieve this feature only by pressing an available chord with your left hand, and then the system will automatically play a preset duet pattern to produce a beautiful melody.

Turn the DUET On/Off

1. Press the [DUET] button, the LED indicator of [DUET] lights up, and the nixie tube currently displays duet type: "d**" (such as "d01") for 2 seconds before it goes back to the main display status.
2. If you want to turn the duet function off, press the [DUET] button again. The nixie tube currently displays "oFF", and the LED indicator of [DUET] goes out.



Select a Duet Type

Press and hold the [SHIFT] button, then press the key marked DUET +/- to select the desired duet type. The nixie tube currently displays type number, for example: "d01".

There are 32 duet types built into this instrument, and the default type is :01.

Note:

This piano has been programmed with an appropriate duet type for each voice. So the duet type can also be changed by different voice settings.



The Split Point of Duet

When the duet function is in use, the keyboard is automatically split into two sections: Chord section in the left-hand area and melody section in the right-hand area. This split point is related to the lower voice split point setting, and the default setting is : F#3 (34).

Operation:

Press and hold the [LOWER] button, then tap any key on the keyboard as the split point. The system will automatically exit the split point setting when you release the [LOWER] button.

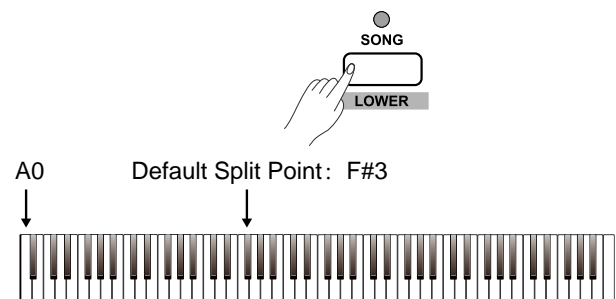

Harmony

With this harmony function, the system will automatically add harmony effect to your performance.

Operation:

1. Press and hold the [SHIFT] button, then press the [HARMONY] button to turn this function on/ off, the default setting is: OFF.
2. Press and hold the [SHIFT] button, then press the key marked HARMONY +/- to select the desired harmony type. The nixie tube displays current number of selected harmony, such as: "H-1". There are 3 preset types of harmony effect, the default setting is: 1 1+5.

Parameter	Harmony Type
1	1+5
2	Octave 1
3	Octave 2

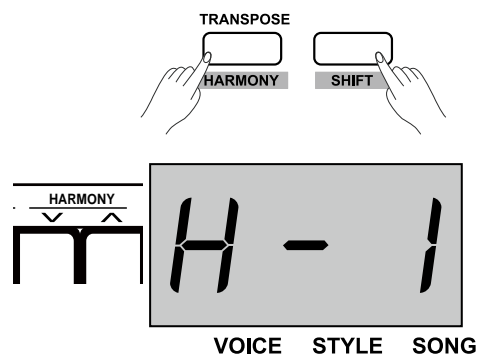

Scale

The equal temperament (has only one tuning method, and is suitable for keyboard instrument) is commonly used in modern music, based on this temperament method to make your own composition and performance. Especially for piano, equal temperament is widely used and taken for granted. But people used several other scales to compose and perform before adopting the equal temperament.

1. Press and hold [SHIFT] button, then press the [SCALE] button to enter the scale mode, and the nixie tube currently displays "on". There are 6 scales built into this instrument, and the default setting is: 1 Pythagor.

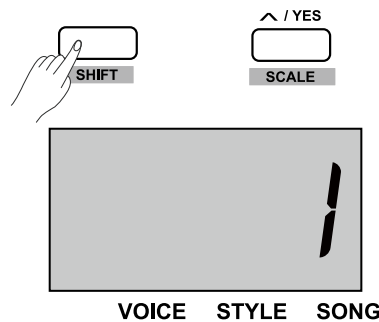

2. Press and hold [SHIFT] button, then press the [SCALE] button to exit the scale mode. And the nixie tube currently displays "oFF".
3. Press and hold the [SHIFT] button, then press key marked SCALE TYPE +/- to select the desired scale type. The nixie tube currently displays the number of scale type.
4. Press and hold the [SHIFT] button, then press the key marked SCALE ROOT +/- to select the desired scale root. The nixie tube currently displays the name of scale root.

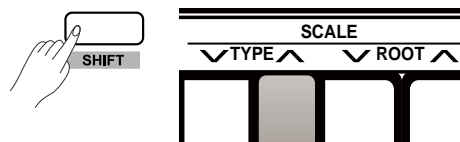

Scale

For example:

You select the "Minor" scale and set its root note "C#".

1. Press and hold [SHIFT] button, then press the [SCALE] button to enter the scale mode.
2. Press and hold the [SHIFT] button, then press the key marked SCALE TYPE +/- to select "3: Minor" scale, and the nixie tube currently displays "3".
3. Press and hold the [SHIFT] button, then press the key marked SCALE ROOT +/- to select root "C#", and the nixie tube currently displays "Cu".

Parameter	Scale Type
1	Pythagorean
2	Pure Major
3	Pure Minor
4	Meantone
5	Werkmeister
6	Kirnberger



TWINOVA

In TWINOVA mode, the keyboard will be divided into two areas with the same pitch and voice.

1. Turn the TWINOVA on/off.
Press and hold the [SHIFT] button, then press the [TWINOVA] button to enter the TWINOVA mode, and the nixie tube currently displays "on". Repeat above button operations to exit TWINOVA mode, and the nixie tube currently displays "oFF". In the TWINOVA mode, DUAL and SPLIT are unavailable, the default split point is E3 (32).
2. Select voice.
Before entering the TWINOVA mode, the default voice of right-hand and left-hand is the upper voice you select. You can press voice direct button or [+YES]/[-NO] button to choose voice.
3. Set the split point.
In the TWINOVA mode, press and hold the [LOWER] button, then tap keys from C3-C6 to set the split point of TWINOVA. Release [LOWER] button to exit the split point setting mode.
4. Set the octave.
In the TWINOVA mode, press and hold the [SHIFT] button, then press the key marked OCTAVE +/- to set octave value of the TWINOVA, and the nixie tube currently displays the octave value, such as "1".

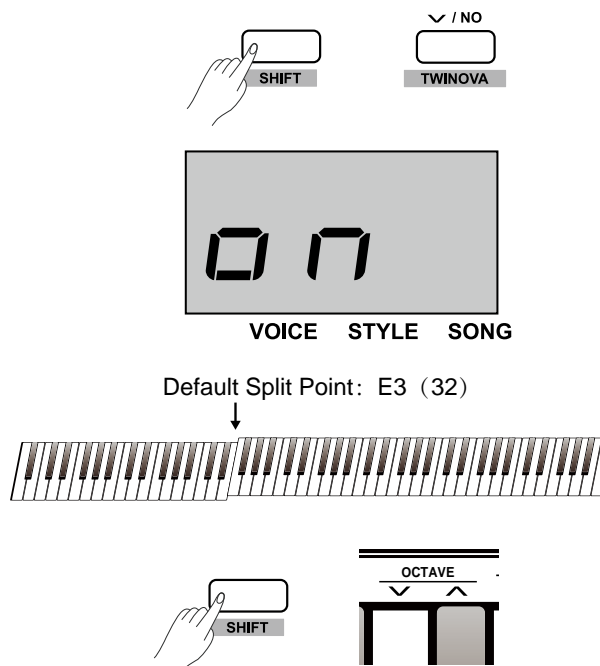

Note:

In the song playing mode, the TWINOVA is invalid.

Beep Tone

This function is used to turn on or turn off the prompt tone. The default setting is turn on.

Operation:

Press and hold the [SHIFT] button, then press the key marked BEEP key to turn the beep tone on or off.

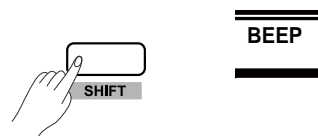

MIDI Function

What's MIDI?

MIDI (short for Musical Instrument Digital Interface) allows a wide variety of electronic musical instruments, computers and other related devices to connect and communicate with one another. MIDI carries event messages that specify notation, pitch and velocity, control signals for parameters such as volume, vibrato, audio panning, and program change information to change the voice selections.

MIDI Terminals

This instrument has been equipped with 2 MIDI terminals: 1 USB terminal and 1 MIDI OUT terminal.

Terminal Rules

In MIDI terminals, we define those devices which control other devices as "master device", and the other controlled devices as "subordinate device". Connect the MIDI OUT terminal of master device to the MIDI IN terminal of subordinate device. The MIDI terminals of the same device cannot be connected. Similarly the same MIDI terminals of different Devices cannot be connected.

MIDI OUT

Connect the instrument MIDI OUT terminal through a standard MIDI cable to a computer or MIDI IN jack of other external audio source. So the MIDI data can be transmitted from the MIDI out to another MIDI device when you play the keyboard or use the MIDI control function. such as: note on/off, voice change, control data and so on. Please refer to MIDI Implementation Chart for details.

MIDI Controller

This instrument has 3 independent MIDI controllers, which can be used to control the MIDI device. Please refer to the detailed procedures as below.

Controller Settings

1. Enter MIDI controller mode
Press and hold [SHIFT] button, then press the [MIDI MODE] button to enter the MIDI controller mode. The LED indicator of [MIDI MODE] lights up.

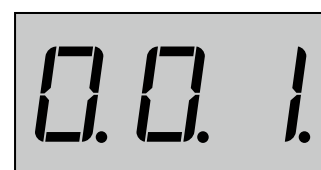
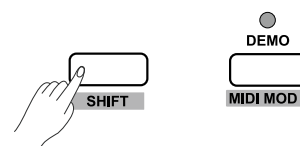

VOICE STYLE SONG

MIDI Function

2. Enter controller edit mode

Press the [MIDI EDIT] button to enter the controller edit mode, the relevant MIDI EDIT indicator will light up.

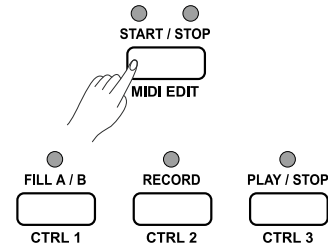

3. Controller select

In the controller edit mode, press one of the [CTRL 1]-[CTRL 3] buttons to individually edit the selected controller. For example, press [CTRL 1] button to enter controller 1 edit, the relevant indicator lights up, and the nixie tube displays command value, then you can edit parameters of controller 1.

4. Command Settings

In MIDI controller edit mode, press [COMMAND] button and the nixie tube currently displays its corresponding command value, the "VOICE" icon will light up. By this time, directly set the command value by pressing the assigned key(s) in the MIDI section to the desired function. There are total 131 MIDI control commands (000-130), and the default value is:001.

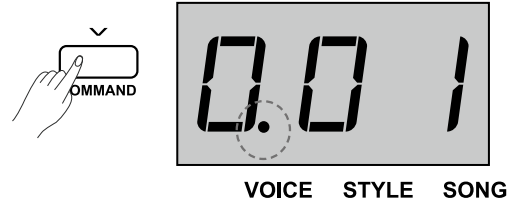

Number	Display	Command
000~127	0.00~1.27	Standard MIDI control (Bn)
128	.Cn	Program change (Cn)
129	.dn	Channel aftertouch (Dn)
130	.En	Pitch bend (En)



Note:

If you press the assigned key(s) to select the desired command value, please press and hold the [shift] button, then tapping 3 consecutive digits. For example, tapping 0,6,4 in sequence to set the command value 64.

5. Data Settings

In MIDI controller edit mode, press the [DATA] button, the nixie tube currently displays the data value of the selected controller, and the "STYLE" icon lights up. By this time, directly set the data value by pressing the assigned key(s) in the MIDI section to the desired function. Available range: 000-127.



Note:

If you press the assigned key(s) to select the desired data value, please press and hold the [shift] button, then tapping 3 consecutive digits. For example, tapping 0,6,4 in sequence to set the data value 64.

6. Channel Settings

In MIDI controller edit mode, press the [CHANNEL] button. The nixie tube displays current controller channel, and the "SONG" icon will light up. By this time, directly set the channel value by pressing the assigned key(s) in the MIDI section to the desired function. Available range: 01-16.

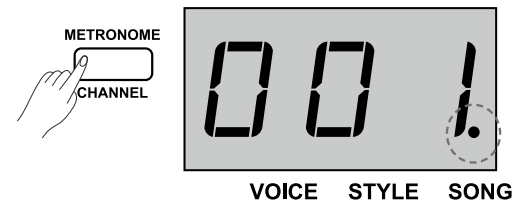

Note:

If you press the assigned key(s) to select the desired channel value, please press and hold the [shift] button, then tapping 2 consecutive digits. For example, tapping 0,1 in sequence to set the channel value 01.

MIDI Function

You can refer to above procedures 3-6 to complete parameter settings of controller 1/2/3. Press [MIDI EDIT] button to exit MIDI controller edit mode, and the relevant indicator will go out.

Note:

- 1) The command value will be the DATA 1 of Bn if it is within the range of 0-127 you set, then the value of DATA 2 can be set by pressing [DATA] button.
- 2) If the number you set is 128, it can be the command Cn, then the data value can be set by pressing the [DATA] button.
- 3) If the number you set is 129, it can be the command Dn, then the data value can be set by pressing the [DATA] button.
- 4) If the number you set is 130, it can be the command En, the value of DATA 2 can be set by pressing the [DATA] button and the DATA 1 will be automatically generated by DATA 2:
If Data2 = 0~126, then Data1=0;
If Data2 = 127, then Data1=127;
In addition:
If Data1=Data2=0, that means the pitch bend is in the lowest level;
If Data1=0, Data2=64, that means the pitch bend is in the middle level;
If Data1=127, Data2=127, which means the pitch bend is in the highest level.

Controller Output

1. Press and hold the [SHIFT] button, then press the [MIDI MODE] button to enter the MIDI controller mode, the LED indicator of [MIDI MODE] lights up.
2. Press the [CTRL 1] button, the LED indicator of [CTRL 1] will keep flashing briefly, it represents the system is transmitting MIDI information of controller 1. Then the relevant MIDI indicator lights up when the transmit process is complete. If you press the [CTRL 1] button again, the MIDI information will be repeatedly transmitted.
3. In the same way, press the [CTRL 2] and [CTRL 3] button, the MIDI information of corresponding controller will be transmitted from the MIDI OUT.
4. In the MIDI controller mode, if you want to exit, press and hold the [SHIFT] button, then press the [MIDI MODE] button.

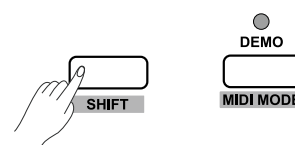
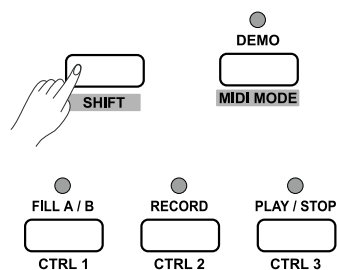

Restore Factory Setting

In shutdown mode, press and hold [+ / YES] and [- / NO] buttons together, then turn the piano on, the system will be restored to factory setting, and delete all recorded data, meanwhile the nixie tube displays "---". After the delete process is complete, the piano will be restored to the state of power-on automatically. Please be careful.

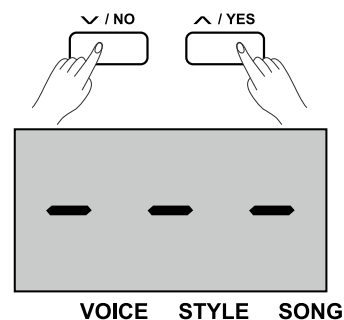

Troubleshooting

Problem	Possible Cause and Solution
The speakers produce a “pop” sound when the power is turned ON or OFF.	This is normal and no cause for alarm.
The instrument is turned on, however no sound is produced when the keys are played.	1. Make sure the volume is set to an appropriate level. 2. Check that a pair of headphones are not connected to the PHONES jack 2.
When using a mobile phone, noise is produced.	Using a mobile phone in close proximity to the instrument may produce interference. To prevent this, turn off the mobile phone or use it far away from the instrument.
The wrong notes sound when the keyboard is played.	Make sure the Tune setting is set to “0”. Press and hold the [+ /Yes] and [- /No] buttons simultaneously, then turn the instrument on to revert settings to default value.
After connecting with the computer, the piano is not recognized.	Please check if the USB cable is being connected firmly, or try to connect another USB port of the computer, without the need to install another driver on the PC.

Specification

Keyboard

88 Keys with Touch Response

Polyphony

64

Voice

20 Voices

Style

50 Styles

Song

60 Songs

Demo

2 Demos

Tempo

30 – 280

Control Button

Power switch, Volume, Demo (MIDI Mode), Tempo- (Command), Tempo+ (Value), Metronome (Channel), Start/Stop (MIDI Edit), Fill A/B (CTRL 1), Record (CTRL 2), Play/Stop (CTRL 3), Voice (Voice Demo), Style (Dual), Song (Lower), Duet, -/No (TWINOVA), +/Yes (Scale), Transpose (Harmony), Shift, 10 Voice direct buttons.

Control Key

Beep, Pedal Resonance Switch, Touch -/+, Tune -/+, Octave-/+, Scale setting, Reverb Setting, Chorus Setting, EQ -/+, Duet -/+, Harmony -/+, Melody Off, Metronome setting, ACCMP Volume -/+, Tempo setting, Style Select, Song Select, MIDI Controller Parameters setting.

Connectors

DC IN, PHONES (2 standard. ¼” phone), AUX IN, AUX OUT, USB, SUSTAIN, MIDI OUT, UNIT PEDALS (Soft, Sostenuto, Sustain).

Power Supply

DC IN 12V/2000mA

Speaker

4ohm 10W x 2
8ohm 20W x 2

Dimensions

1365(W) x 366(D) x 137(H) mm

Weight

10.7Kg

* All specifications and appearances are subject to change without notice.

Voice List

NO.	Name
Piano	
1	Grand Piano
2	Grand Piano 2
3	Ele. Piano
4	Ele. Piano 2
5	Ele. Piano 3
6	Harpichord
Chromatic Percussion	
7	Clavi
8	Vibraphone
Organ	
9	Percussive Organ
10	Drawbar Organ
11	Church Organ
12	Reed Organ
13	Rock Organ
14	Accordion
15	Harmonica
Guitar	
16	Acoustic Guitar (nylon)
17	Electric Guitar (clean)
Bass	
18	Electric Bass (finger)
Strings & Orchestral Instruments	
19	String Ensembles
20	Synth Strings

Style List

NO.	English Name
1	Romantic 8beat
2	Pop 8Beat
3	Slow Rock
4	Lyric 3Beat
5	Pop Waltz
6	Slow Waltz
7	Waltz 1
8	Waltz 2
9	Waltz 3
10	Vienna Waltz
11	March 1
12	March 2
13	Polka
14	Italian Polka
15	Jazz Pub
16	Jazz 1
17	Jazz 2
18	Jazz 3
19	Jazz 4
20	Jazz 5
21	Boogie
22	Jive
23	Dixland
24	Latin
25	Tango
26	Lambada
27	Samba
28	ChaCha
29	Beguine
30	Salas
31	Pop Bossa
32	Blues 1
33	Blues 2
34	Blues 3
35	Jazz Bluse
36	Piano Beat
37	Piano Bar
38	Pop 1
39	Pop 2
40	Pop 3
41	Pop 4
42	Pop Country
43	Pianist 1
44	Pianist 2
45	Ballad 1
46	Ballad 2
47	Ballad 3
48	Ballad 4
49	6/8 Ballad
50	6/8 Ballad 2

Song List

NO.	English Name
1	Waltz For Piano In g-Sharp Minor
2	The Happy Farmer
3	Etude
4	Dance Of The Four Swans From "Swan Lake"
5	Carmen Suite No.2 Habanera
6	A Little Polish Dance
7	Jesus Saviour Pilot Me
8	Old Macdonald Had A Farm
9	O Sole Mio
10	Wedding March From "Mendelssohn"
11	2-Part Invention No.13 In A Minor BWV 784
12	Turkish March
13	Italian Polka
14	Musette
15	Bourree
16	To A Wild Rose
17	Away In A Manger
18	Fur Elise
19	The Marriage Of Figaro
20	Angels We Have Heard On High
21	Waltz
22	America The Beautiful
23	Did You Ever See A Lassie
24	Arabesque
25	Old France
26	Santa Claus Is Coming To Town
27	Music Box Dancer
28	Symphony No.9 In e Minor Large From "The New World"
29	Larghetto
30	French Suite No. 5 in G Major, BWV 816 - IV. Gavotte
31	Mazurka
32	Minuet 1
33	Minuet 2
34	Minuet 3
35	Minuet In G
36	Neapolitan Song
37	Prelude In E Major
38	Salut D'Amour
39	Pizzicato Polka
40	Piano Sonata No.11 in A major K331 I. Andante grazioso
41	Songs Without Words Op30 No .6 F sharp minor Venetian Gondola Song
42	Duke Aria From "The Rigoletto"
43	Burgmuller Op.100 No.15 - Ballade
44	Spinning Song
45	In The Theatre
46	Alfredo and Violetta Column Tower Duet
47	Come Back To Sorrento
48	Piano Sonatina In F Major
49	Tchaikovsky Waltz
50	Military March No.1 In D Major
51	Als Die Alte Mutter Mich Noch lehrte Singen
52	Etude on Leger Lines 1
53	Etude on Leger Lines 2
54	At the Ball
55	Dancing Raindrops
56	From a Story Book
57	Comin' 'Round the Mountain
58	Song of the Brook
59	Puck
60	Cotton-pickin' Fingers

Demo List

No.	English Name
1	Fantasia
2	Chpn_op25_no1

MIDI Implementation Chart

Function	Transmitted	Recognized	Remarks	
Basic Channel	Default Changed	1ch 1-16ch	ALL 1-16ch	
Mode	Default Messages Altered	x x *****	3 3 x	
Note Number	Note :True voice	0—127 *****	0—127 0—127	
Velocity	Note on Note off	o 9nH,V=1-127 x (9nH,V=0)	o 9nH,V=1-127 o(9nH,V=0; 8nH,V=0-127)	
After Touch	key's Ch's	x x	x x	
Pitch Bend		x	o	
Control Change	0 1 5 6 7 10 11 64 65 66 67 80 81 91 93 120 121 123	o x x o o x x o o o o x x o o x x o	o o o o o o o o o o o o o o o x x o	Bank Select Modulation Portamento Time Data Entry Volume Pan Expression Sustain Pedal Portamento ON/OFF Sostenuto Pedal Soft Pedal Reverb Program Chorus Program Reverb Level Chorus Level All Sound Off Reset All Controllers All Notes Off
Program Change	:true	o *****	o 0—127	
System Exclusive		x	o	
System Common	:SongPosition :Song Select :Tune	x x x	x x x	
System Real Time	:Clock :Commands	o x *1	x x *1	
Aux Messages	:LOCAL ON/OFF :Active sense :Reset	x o x	x o o	
Notes:	*1 When the accompaniment is started, an FAH message is transmitted. When accompaniment is stopped, an FCH message is transmitted.			

- Mode 1: OMNI ON, POLY
- Mode 2: OMNI ON, MONO

- Mode 3: OMNI OFF, POLY
- Mode 4: OMNI OFF, MONO

- o: YES
- x: NO

Scale Tuning System

A tuning system is the system used to define which tones, or pitches, to use when playing music. In other words, it is the choice of number and spacing of frequency values used. The equal temperament (has only one tuning method, and is suitable for keyboard) is the common musical scale used at present, used for the tuning of pianos and other instruments of relatively fixed scale. One of the advantages of the equal tempered scale is that it is the same in any musical "key", so that compositions may be freely transposed up or down without changing the musical intervals. Especially for piano, equal temperament is widely used and taken for granted. But people used several other scales to compose and perform before adopting the equal temperament. This piano has been equipped with 6 scale tuning systems, you can select one to reappearing its matched chord of the melody at that time.

Characteristics of Different Scale Tuning Systems

Pythagorean

The Pythagorean tuning, named after the ancient mathematician and philosopher Pythagoras, is based on a stack of intervals called perfect fifths. It is particularly well suited to music which treats fifths as consonances, and thirds as dissonances.

Pure Major & Pure Minor

In music, just intonation (sometimes abbreviated as JI) or pure intonation is any musical tuning in which the frequencies of notes are related by ratios of small whole numbers. Any interval tuned in this way is called a pure or just interval. And the major scale which consisted of just intonations especially for this triad chords: Root, Third, Fifth are sounded extremely harmony. The just intonation must be the most natural temperament.

Meantone

The Meantone System is a musical temperament which is close to just intonation. Used to tuning pipe organ in 16th century Europe. These musical scales which based on the Pythagorean System, minus quarter of common comma for once, are extremely approaching just intonation. So, use this system to create musical scales are sound beautiful and pure, just like a perfect triad chord.

Werckmeister

The Werkmeister was named after Andreas Werckmeister, and this scale was created as an improvement on the Pythagorean scale. This tuning collapse comma maxima, created by Pythagorean, into four perfect fifths, the rest fifths still remain their Pythagorean scale characteristics. Werkmeister Tuning can tune scale from harmonic to melodic by increasing tone number, making each tonality sound distinct, this is the important gist for classicists and romanticism tonality music to name the tone name.

Kirnberger

Kirnberger temperament is an irregular temperament developed in the second half of the 18th century by Johann Kirnberger and regarded as an improved version of Meantone temperament. It makes possible to switch different tunes freely when performing.

Twelve-tone equal temperament

In twelve-tone equal temperament, which divides the octave into 12 equal parts, the width of a semitone, i.e. the frequency ratio of the interval between two adjacent notes, is the twelfth root of two. There is minute difference of the same amount between each two intervals.

