

Studiophile BX5

Users Manual

Introduction	2
What's in the Box?	2
Studiophile BX5 Features	2
Front and Rear Panel Features	4
Rear Panel	4
Front Panel	6
Installation	6
Precautions	6
XLR Balanced Connection	7
TRS Balanced/Unbalanced Connection	7
Connecting to Preamp, Computer or Game Console Outputs	8
Setting the EQ Switches	8
Setting the Acoustic Space Switch	10
Placing the BX5	11
Appendix A - Technical Specifications	12
Appendix B - Block Diagram	13
Technical Support & Contact Information	14
Your BX5 Warranty	15

Introduction

Thank you for choosing the BX5 Studiophile Series bi-amplified studio nearfield monitor speakers. M-Audio is well known for digital audio interface technology, digital converters, audio preamps and mixers. Now, after extensive research and development, the Studiophile BX5 is born to change the concept of studio reference monitoring.

The BX5 was designed and tested by veteran audio engineers to meet your needs in a studio monitoring environment. It is focused on the functional goal of delivering pure, original sound without any additional coloration. The BX5 monitor is self-powered, directly accepting a line level signal from a variety of sources.

The Studiophile BX5 is designed to overcome all the limitations of conventional studio reference monitors within the digital audio environment. This system delivers a wide range frequency response by employing two extraordinary drivers and unique crossover technology licensed by M-Audio. It boasts a stable and balanced low-mid frequency response along with a defined mid- and high-frequency response as well. Both drivers are magnetically shielded for desktop music production.

From pro engineers at commercial studios to home studio owners, the Studiophile BX5 sets a new affordable standard in studio monitoring.

What's in the Box?

Your Studiophile BX5 box contains:

- Two BX5 speakers
- Two detachable AC power cords
- This manual
- Actual test results of the BX5 you purchased

Studiophile BX5 Features

1. Woofer

The woofer unit is 5 inches in diameter with a magnetically shielded mineral-filled polypropylene cone, high-temperature voice coil and damped rubber surround. It is designed to deliver balanced mid- and low- frequency response. Polypropylene is used to react against the input signals accurately and to deliver even minimal input precisely while minimizing distortion.

2. Tweeter

By employing a specially developed 1-inch silk dome with magnetic shielding, the tweeter can deliver distortion-free original sound and offer extremely natural response. It minimizes reaction time by using fabric silk for excellent delivery, and also minimizes resonance by adapting a unique internal damping technology.

3. Sub-Frequency Port

The hole in the rear panel is called a Sub-Frequency Port and is designed to discharge extreme low frequencies under 60 Hz.

4. EQ and Acoustic Space Controls

Back panel controls on the BX5s give you compensation for room EQs as well as compensation for the positioning of the speakers within your room. High frequency cuts, mid-range boost, and low frequency cutoffs offer a great deal of control over the sound and presence of the BX5s, while the “Acoustic Space” settings account for a variety of speaker placements.

5. Enclosure

Just as other components do, the BX5's enclosure has an important role. In order to provide more stable performance, the BX5's enclosure employs a special high-density MDF and unique interior reinforcement designed to absorb vibration and impact generated under extreme conditions.

6. Network & Power Amplifiers

The active crossover networks & power amplifiers for the BX5 are specially designed for this woofer and tweeter. The network properly distributes low, mid, and high frequencies to the components in order to reduce distortion and loss of sound, thus achieving a naturally balanced sound.

In order to generate powerful, ultra-crisp sound, there are two separate power amplifiers inside the BX5 to drive the woofer and tweeter separately in a high-end bi-amp structure. The power delivered to the woofer driver at a rated distortion is 38W, and 38W is also delivered to the tweeter.

Front and Rear Panel Features

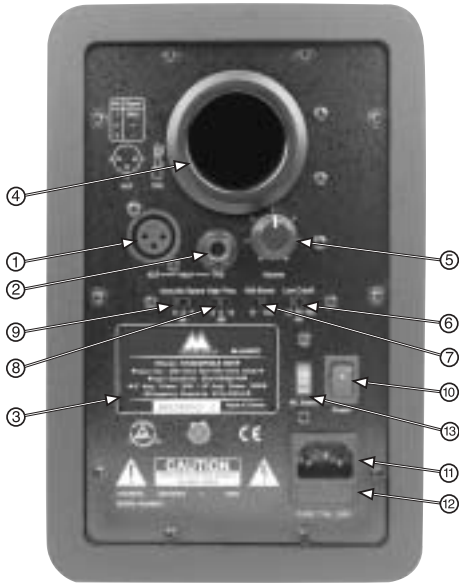

Rear Panel

1. XLR INPUT: This jack accepts XLR input connections with either balanced or unbalanced wiring. The input wiring of an XLR connector should be as follows:

XLR PIN 1	Signal ground (Shield)
XLR PIN 2	Signal positive (+)
XLR PIN 3	Signal negative (-)

2. TRS INPUT: This jack accepts 1/4" connections with either balanced or unbalanced wiring. For balanced wiring, a three-conductor TRS plug is necessary. The input wiring of a TRS connector should be as follows:

TRS TIP	Signal positive (+)
TRS RING	Signal negative (-)
TRS SLEEVE	Signal ground (Shield)

Unbalanced 1/4" wiring can be done with either a two- or three-conductor (TS or TRS) plug. A two-conductor (TS) plug automatically grounds the signal negative input, whereas a three-conductor (TRS) plug, wired unbalanced, provides the option of leaving the negative input open or grounded. We recommend that you ground the unused negative input (this can be done by wiring the ring and sleeve of the TRS plug together).

The TRS input is summed through a balanced input amplifier with the XLR input, allowing both inputs to be used simultaneously. Input specifications apply to both.

3. **PRODUCT LABEL:** This label contains the model and serial number information.
4. **VENT PORT:** This port aids in reproduction of very low frequencies by discharging frequencies below 60 Hz.
5. **VOLUME CONTROL:** Use the volume control to set the output sound pressure from the BX5 to proper levels as required.
6. **LOW CUTOFF:** This 3-position switch sets the bass rolloff frequency. The lowest setting, 56Hz, is essentially a low cutoff bypass as it does not attenuate the BX5's frequency response. Other settings are 80Hz and 100Hz.
7. **MID-BOOST:** Two selections are available, "In" and "Out." The Out setting produces a flat frequency response curve, while the In setting gives a boost in the mid-range frequencies.
8. **HIGH FREQ:** Three settings are possible, -2dB, 0dB, and +2dB. 0dB is a "flat" setting with no attenuation, while the -2dB and +2dB settings will attenuate or boost the high frequencies (3kHz shelf) by -2dB and +2dB respectively.
9. **ACOUSTIC SPACE:** This 3-position switch is designed to compensate for different speaker placements. Please see the section "Setting the Acoustic Space Switch" for more information.
10. **POWER SWITCH:** This switch turns the monitor on and off. The on position is indicated with the marking "." (a white dot).
11. **POWER RECEPTACLE:** Accepts a detachable 3-circuit line cord in order to power the monitor.
12. **FUSE HOLDER:** Holds the external main fuse.
13. **VOLTAGE-SELECT SWITCH:** Provides 2 selections, 115VAC and 230VAC, and should be set to match the "house supply" (receptacle) voltage of the country or location in which the speaker is used. The 115V setting is correct for the USA, while the 230V setting is correct for most of the UK and Europe.

Front Panel

The front panel houses the Power LED, which indicates whether the speakers (amplifier) power is on or off.

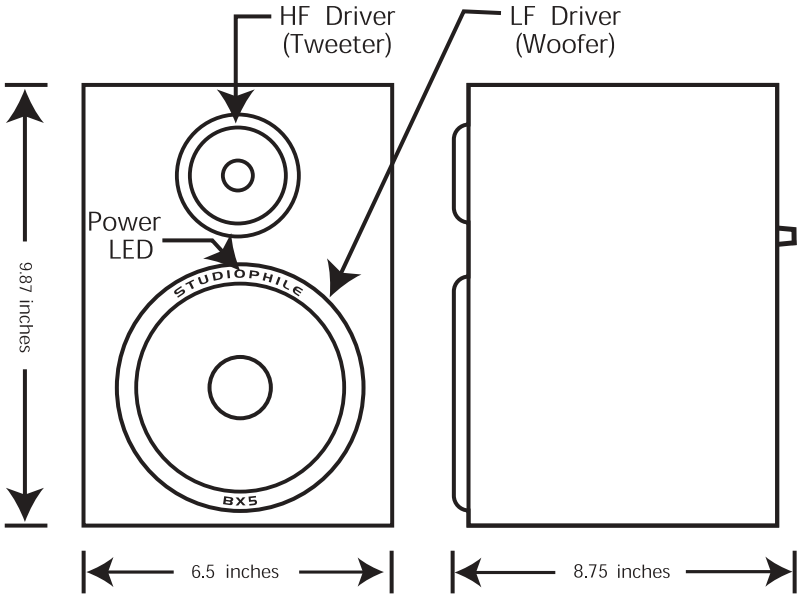

Installation

For optimal performance of the BX5, please read the following thoroughly and carefully prior to installation.

Precautions

Handling: Please do not touch the speaker cones. The BX5 set is packaged in the box tightly, so your attention is required when taking the monitors out of the box. To avoid possible damage to the speaker units, hold both sides of the monitor in order to pull it out of the box. The speaker cones should not be touched in order to avoid damage even after they are out of the box.

Connections: Connect the XLR balanced or TRS balanced/unbalanced input of each BX5 to the corresponding pre-amp, computer or game console outputs. We recommend that you use high-quality balanced or unbalanced cables for input connections. Also, turn off the power of the BX5 and turn the volume of the BX5 down to a minimum before making the necessary connections.

Correct Power Operation: Since the BX5 contains its own amplifier, it must be connected to a power outlet using the detachable AC cable provided. Before connecting power, please make sure that the Voltage-Select Switch located on the speaker's rear panel is set to the appropriate position, as described in the rear-panel features list appearing earlier in this manual.

WARNING! - Use of improper Voltage-Select Switch combinations may result in hazardous conditions and/or damage to speaker components not covered by speaker warranty.

XLR Balanced Connection

Assure that the power switch of the BX5 is turned off and that the volume control of the BX5 is turned down to a minimum. Connect the male end of an XLR balanced cable to the balanced input of the BX5 (refer to the following diagram for balanced connection).

TRS Balanced/Unbalanced Connection

Assure that the power switch of the BX5 is turned to Off and that the volume control of the BX5 is turned down to a minimum. Connect the male end of a TRS balanced or TS unbalanced cable to the TRS input of the BX5 (refer to the following diagram for TRS connection).

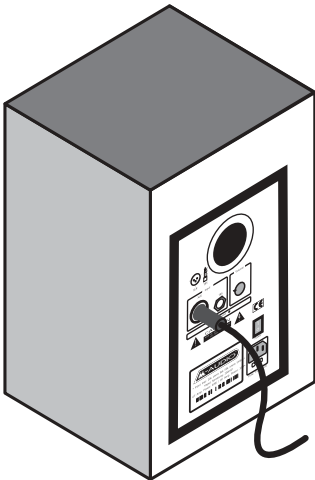

XLR Balanced Connection

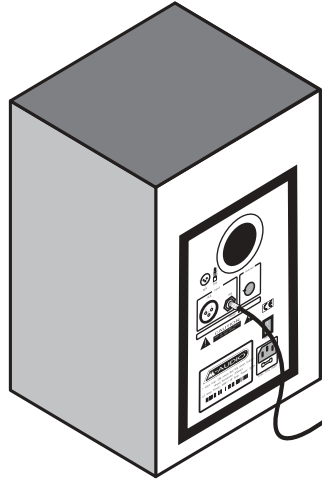

1/4" TRS Balanced or Unbalanced Connection

Connecting to Preamp, Computer or Game Console Outputs

Before connecting, make sure the output device's power has been turned off.

Plug the XLR balanced, TRS balanced or TS unbalanced cable to the corresponding output connectors of a pre-amplifier, computer or game console.

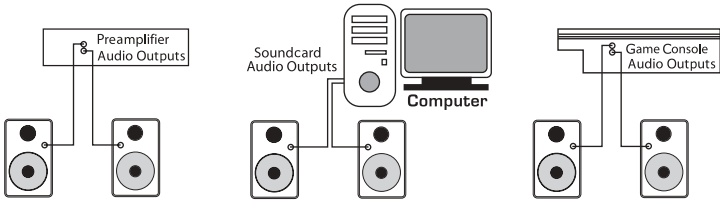

Setting the EQ Switches

Low Cutoff: This 3-position switch sets the Low Cutoff frequency, selecting between 56Hz, 80Hz and 100Hz. Use the 100Hz setting to emulate a small speaker setup, the 80Hz setting for Normal Low Frequency performance, or the 56Hz for Normal Extended Low Frequency performance. The 80Hz and 100Hz settings can also be used in conjunction with a subwoofer, when the subwoofer is set up to receive the low-frequency material below 80Hz and 100Hz (respectively).

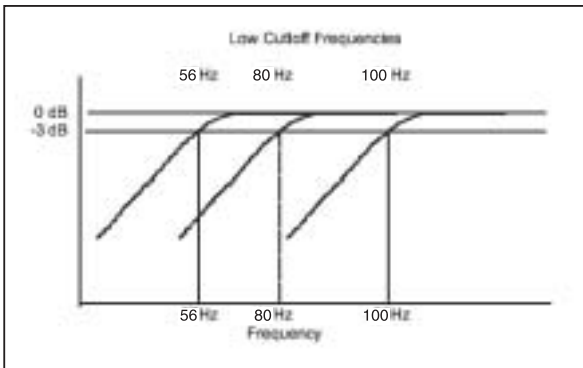

Mid-Boost:This 2-position switch selects between the “In” and “Out” Mid-Boost modes.The Out mode produces a flat midrange response for normal monitoring conditions, while In will move the sound stage forward toward your listening position.

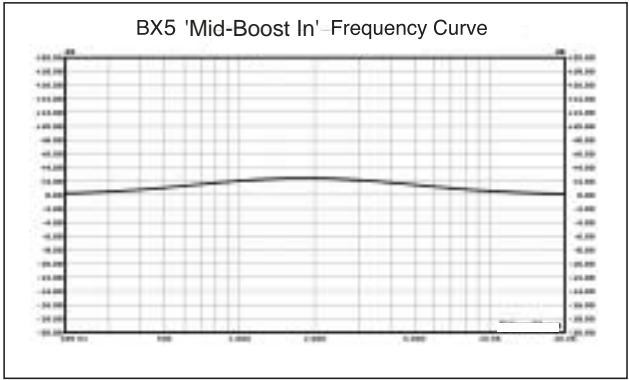

High-Freq:This 3-position switch selects High Frequency compensation with -2dB, 0dB or +2dB.The 0dB (normal) position produces flat response for use in most common applications. Use -2dB if your mixes translate as dull or lacking in high frequencies (lowering the high-frequency response will inspire the mix engineer to add more highs). Use the +2dB setting for brighter-sounding audio playback, or to compensate for mixes that translate as too bright.

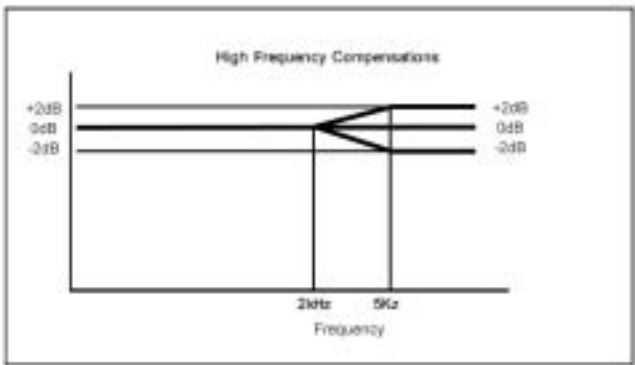

Setting the Acoustic Space Switch

The Acoustic Space switch is a 3-position switch used to select the "Acoustic Space" in which the speaker is placed—Half Space (speakers against wall, 0dB position), Three-Quarter Space (speakers in corners or close to wall, -2dB position), or Full Space (speakers away from wall, -4dB position). The benefits of using this switch are explained in the following paragraphs.

The bass response of any loudspeaker will differ depending on its placement. If the speaker is placed close to a wall, the bass will sound louder than when it is placed on a speaker stand. The technical term for this phenomenon is called Diffraction Spreading and can be explained as follows:

Below a certain frequency, the sound emitted from a speaker begins to change its polar radiation pattern, from 180 degrees to 360 degrees. With the speaker placed close to a wall, its energy can be physically radiated only forward, thereby limiting the radiation polar pattern to 180 degrees. When the speaker is placed on a stand, the low-frequency energy is free to radiate in 360 degrees. While there is a theoretical difference of about 6dB in low-frequency response between these two placements, the loss (from the wall placement to the speaker stand placement) is, in practice, normally found to be about 4dB.

Note: At medium and high frequencies, Diffraction Spreading losses do not occur because the front baffle of the speaker affects low-frequency energy radiation much like a large area (like a wall). So at medium and high frequencies, the radiation pattern is always limited to 180 degrees.

The Acoustic Space switch compensates for (Diffraction Spreading) low-frequency loss by introducing a complimentary correction filter with the three filter settings (0dB, -2dB and -4dB) and allows you to place the BX5 speakers close to a wall, on speaker stands, or somewhere in between these two (such as on a small table top) with the same resulting low-frequency output produced from each placement.

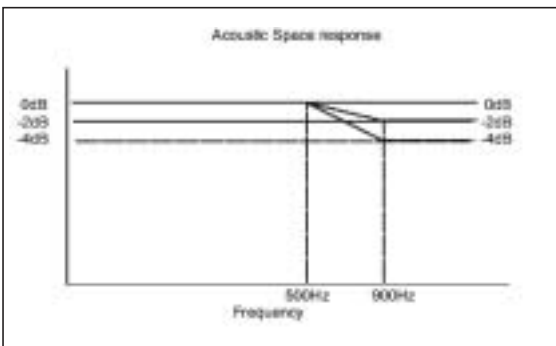

Placing the BX5

Placing the speakers is one of the most important procedures in order to monitor sound accurately. To monitor with the BX5s performing to their maximum capability, an appropriate listening environment and correct placement are required. Please refer to the following for correct BX5 placement.

1. The two units and the listener should basically align to form a regular triangle. Refer to the following diagram.

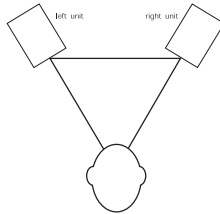

2. Position the monitors so that the top of the woofers are level with your ears in a normal listening environment. Refer to the following diagram.

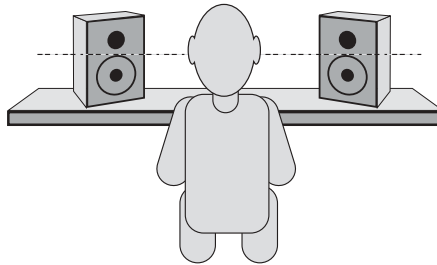

3. Place the BX5s vertically with the woofer on the bottom. Placing the BX5s horizontally is not recommended.

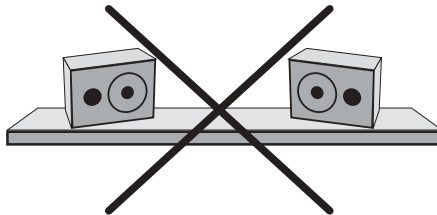

Remarks: DO NOT place any obstacles that may block the flow of air in front or between the BX5s. Also remove reflective materials such as glass, mirrors or metal from the monitoring environment. PLACE THOSE MATERIALS AWAY FROM THE PATH OF THE SOUND FROM THE BX5s.

Appendix A - Technical Specifications

Type: Two-way studio reference

LF Driver: 5-inch dia., magnetically-shielded with curved mineral-filled polypropylene cone, high temperature voice coil and damped rubber surround

HF Driver: 1-inch dia., magnetically-shielded with natural silk dome

Frequency Response: 56Hz - 20kHz

Crossover Frequency: 3.0kHz

LF Amplifier Power: 38W

HF Amplifier Power: 38W

S/N Ratio: >100dB below full output, 20kHz bandwidth

Input Connectors: One XLR balanced input connector; one TRS balanced/unbalanced input connector

Polarity: Positive signal at + input produces outward low-frequency cone displacement

Input Impedance: 20k ohms balanced, 10k ohms unbalanced

Input Sensitivity: 85 mV pink noise input produces 90dBA output SPL at 1 meter with volume control at maximum

Acoustic Space Control: 0dB, -2dB, -4dB

High Frequency Control: -2dB, 0dB, +2dB

Mid-Boost Control: In, Out

Low Cut-off Frequencies: 56Hz, 80Hz, 100Hz

Protection: RF interference, output current limiting, over temperature, turn on/off transient, subsonic filter, external main fuse

Indicator: Blue power on/off indicator on front panel

Power Requirements: Dual-voltage (selectable by rear-panel switch) for either 115V/~60Hz, 230V/~50Hz; powered via detachable 3-circuit line cord

Cabinet: vinyl-laminated MDF

Dimension: 250 mm (H) x 166 mm (W) x 200 mm (D)

Weight: 5kg/unit (without packing)

* Above specifications subject to change without notice

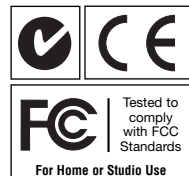

Appendix B - Block Diagram

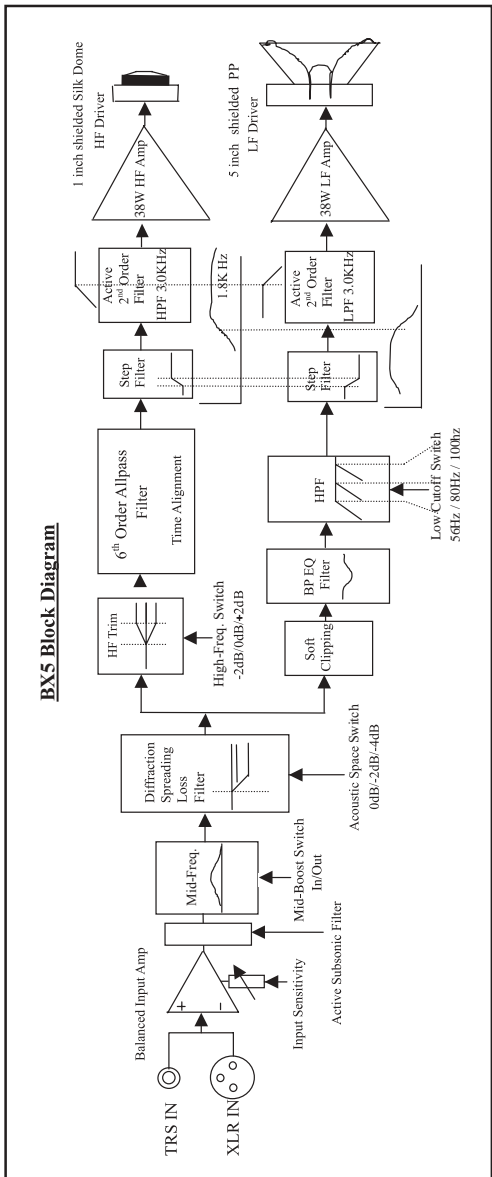

Technical Support & Contact Information

For additional help, contact M-Audio Technical Support by telephone (626-445-7556, 9-5 PST M-F), by fax (626-445-8407) or by e-mail (techsupt@m-audio.com).

If you have any questions, comments or suggestions about this or any M-Audio product, we invite you to contact us directly at:

M-AUDIO U.S.

45 E. Saint Joseph St.
Arcadia, CA 91006-2861
U.S.A.

Sales Information:	626-445-2842
Sales Information (email):	info@m-audio.com
Tech Support:	626-445-8495
Tech Support (email):	techsupt@m-audio.com
Fax:	626-445-7564
Internet Home Page:	http://www.m-audio.com

M-AUDIO U.K.

Unit 5, Saracen Industrial Park
Mark Rd.
Hemel Hempstead, Herts HP2 7BJ
England

Sales Information:	44 (0) 144 241 6590
Sales Information (email):	info@maudio.co.uk
Technical Support:	44 (0) 871 717 7102
Technical Support (email):	richard@maudio.freemove.co.uk
Fax:	44 (0) 144 224 6832
Internet Home Page:	http://www.maudio.co.uk

M-AUDIO Deutschland (Germany)

Kuhallmand 34
D-74613 Ohringen
Germany

Sales Information:	49 7941 98 7000
Sales Information (email):	info@m-audio.de
Technical Support:	49 7941 98 70030
Technical Support (email):	support@m-audio.de
Fax:	07941 98 70070
Internet Home Page:	http://www.m-audio.de

M-AUDIO Canada

1400 St. Jean-Baptiste Ave., #150
Quebec City, QC G2E 5B7
Canada

Tel:	418-872-0444
Fax:	418-872-0034
Email:	midimancanada@m-audio.com
Internet Home Page:	http://www.m-audio.ca

M-AUDIO Japan

Annex Building 6F
2-18-10 Marunouchi
Naka-Ku, Nagoya 460-0002
JAPAN

Tel:	81 52 218 3375
Fax:	81 52 218 0875
Email:	info@m-audio.co.jp
Internet Home Page:	http://www.m-audio.co.jp

Your BX5 Warranty

M-AUDIO warrants that this product is free of defects in materials and workmanship under normal use for a period of One (1) year from purchase date, so long as the product is: owned by the original purchaser; the original purchaser has proof of purchase from an authorized M-AUDIO dealer; and the purchaser has registered his/her ownership of the product by sending in the completed warranty card.

This warranty explicitly excludes any included external non-integrated power supplies and cables which may become defective as a result of normal wear and tear.

In the event that M-AUDIO receives written notice of defects in materials or workmanship from such an original purchaser, M-AUDIO will either replace the product, repair the product, or refund the purchase price at its option. In the event any repair is required, shipment to and from M-AUDIO and a nominal handling charge shall be borne by the purchaser. In the event that repair is required, a Return Authorization number must be obtained from M-AUDIO. After this number is obtained, the unit should be shipped back to M-AUDIO in a protective package with a description of the problem and the Return Authorization clearly written on the package.

In the event that M-AUDIO determines that the product requires repair because of user misuse or regular wear, it will assess a fair repair or replacement fee. The customer will have the option to pay this fee and have the unit repaired and returned, or not pay this fee and have the unit returned unrepaired.

The remedy for breach of this limited warranty shall not include any other damages. M-AUDIO will not be liable for consequential, special, indirect, or similar damages or claims including loss of profit or any other commercial damage, even if its agents have been advised of the possibility of such damages, and in no event will M-AUDIO's liability for any damages to the purchaser or any other person exceed the price paid for the product, regardless of any form of the claim. M-AUDIO specifically disclaims all other warranties, expressed or implied. Specifically, M-AUDIO makes no warranty that the product is fit for any particular purpose.

This warranty shall be construed, interpreted, and governed by the laws of the state of California. If any provision of this warranty is found void, invalid or unenforceable, it will not affect the validity of the balance of the warranty, which shall remain valid and enforceable according to its terms. In the event any remedy hereunder is determined to have failed of its essential purpose, all limitations of liability and exclusion of damages set forth herein shall remain in full force and effect.

Notes: