



Operating Instructions

- Individual Mediacenter
- Individual Mediacenter DR+





LOEWE.

233-33591.021





Brief Instructions for Individual Mediacenter / DR+













Preparation

- TV operation remote control 
- Mediacenter remote control 
- Switch device on/off 
- Insert disk  Insert disk in the slot-in disk drive on the right side
- Eject disk  Operating panel on the device





Operating modes

- Main Menu 
- Menu selection 
- Settings Menu 

Play

- DVD/CD player  - DVD/CD player - Select title
- Music  - Music - Category - Select media
- Play 
- Pause 
- Stop 
- Forward (press several times) 
- Backward (press several times) 
- Next/Previous Chapter 
- Volume 
- Sound on / Mute 
- Detailed information/DVD title menu 
- Close/ go back in menu 
- Menu Now Playing 

Radio

- FM radio  - Radio - FM radio - Stations by Name - select radio station
- Internet radio  - Radio - Internet radio - Category - Select radio station
- DVB radio  - Radio - DVB radio - Select station
- Screen off/on 

Audio CD Import

- CD Import  - DVD/CD player - Import - CD import

Assist Remote Control – Mediacenter Operation

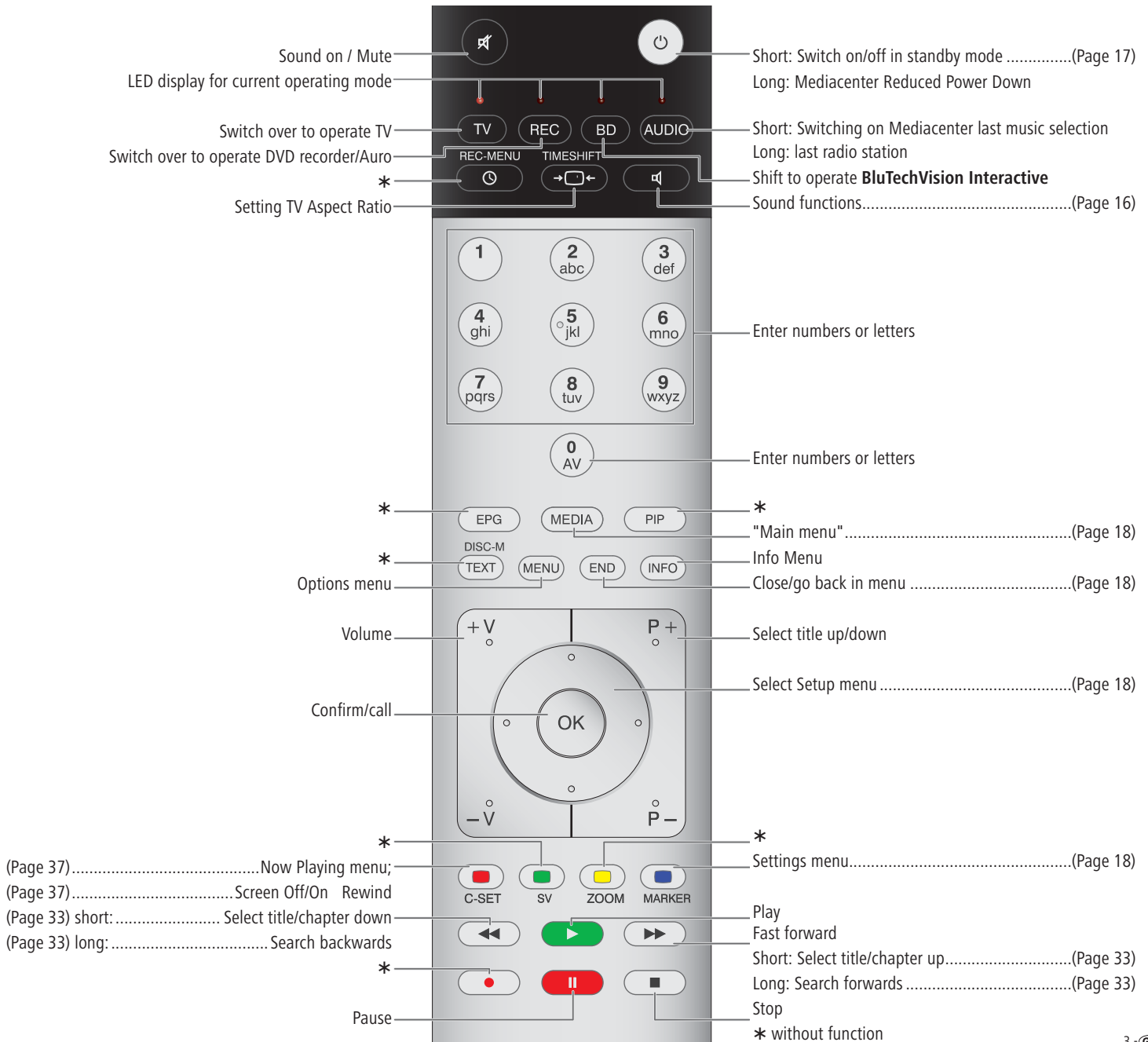

Contents

Brief Instructions for Individual Mediacenter / DR+	2
Assist Remote Control – Mediacenter Operation	3
Front / Side view	6
Back	7
Welcome	8
Scope of delivery	8
Operating requirements	8
Setup	8
For your Safety	9
Performance	10
Setting up	11
Suggested setup solution: 5.1 Audio System	11
Suggested setup solution: Stereo Audio System	11
Suggested setup solution: Multiroom System	12
Connecting	13
Mediacenter in the integrated TV system	13
Mediacenter with Loewe Sound Projector and Loewe Flat TV Set	14
Mediacenter as a Standalone Solution	15
Start-up	16
Using the remote control for the first time	16
Setting up the Assist Remote Control	16
Operating Loewe Equipment	16
Connecting to the Mains Supply	17
Switching On/Off	17
Digital Link HD (HDMI CEC)	17
Product Registration	17
Main Menu	18
Navigation in the Menu	18
Settings Menu	18
Menu Language	18
Network	19
Wired network	19
Wireless network	21
Mediacenter Network Name	22
Network Share	22
Reduced Power Down	23
Standby Timer	23
Screen Saver	23
Automatic Return to Play	23
Time Zone	23
Privacy Policy	23
Movie Audio	24
Sound mode	24
Dolby Pro Logic II Mode	24
Sound Adjustment	24

Loudness	25
Max Volume	25
Switch On Volume	25
Night mode	25
Sound Components	26
TV Resolution	28
TV Type	28
DVD Playback Frequency	28
HDMI Settings	29
Set Video Defaults	29
Parental Controls	29
Movie Ratings	29
Start-up	30
System Information	30
Storage information	30
My Content	30
Delete Music	30
Start-up	31
Restart System	31
Update Software	31
Play CD and DVD	32
Preconditions	32
Play CD	33
Read Disc	33
CD Play	33
Show Songs	33
Edit Music Info	34
CD Settings	34
Play DVD	35
Read Disc	35
DVD Play	35
DVD history	36
Edit Movie	36
Music Menu	37
Now Playing	37
Playlists	37
Artists	38
Music Menu	39
Albums	39
Track	39
Music Menu	40
Covers	40
Genres	40
Music Options	41
Search	41

Contents

Play from iPod	42
Connecting iPod.....	42
Menu iPod	42
Now Playing (iPod).....	42
Playlists (iPod).....	42
iPod Music.....	43
iPod options.....	43
Radio Operation.....	44
Setting FM Radio	44
Stations by Names/Frequency.....	45
Now Playing - FM Radio	45
Internet Radio.....	46
Listening to Internet Radio.....	46
Now Playing - Internet radio	46
Internet Radio Favourites	47
DVB radio	48
Listening to DVB Radio	48
Sources	49
Wired Audio Sources.....	49
External memories	49
USB Operation	49
Importing Music	50
Audio-CD Import.....	50
Copying Music to Harddisk	50
Music Server	51
Setting up Music Server	51
Multiroom Operation	51
Party Mode.....	52
Copying Covers to Harddisk	52
Troubleshooting.....	53
Index of key words	54
Glossary	56
Technical specifications	57
Company and editorial details.....	57
Environment	58
Environmental Protection	58
Legal notices.....	58
EC Declaration of Conformity	60
Service	61

Front / Side view

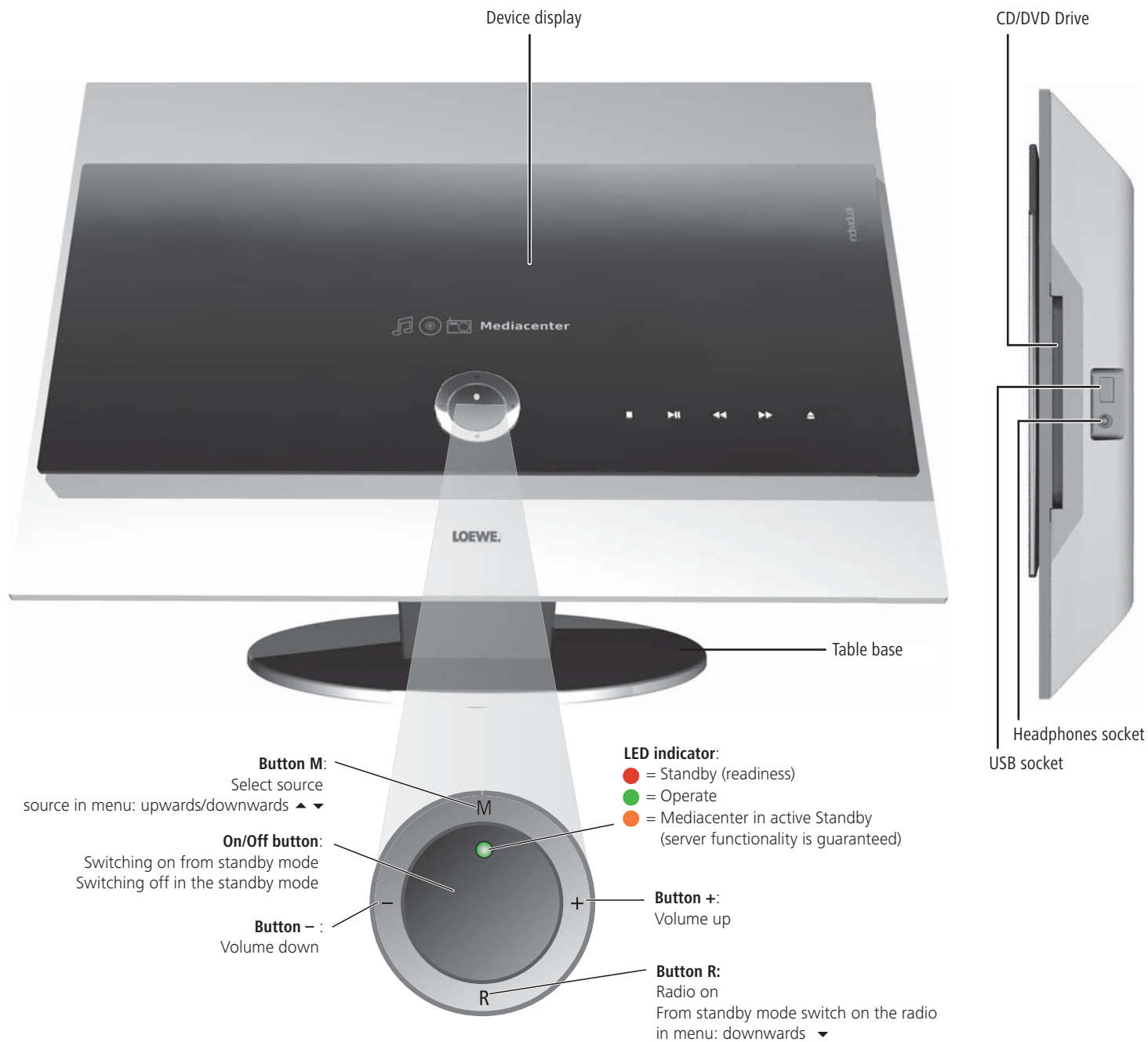

Back

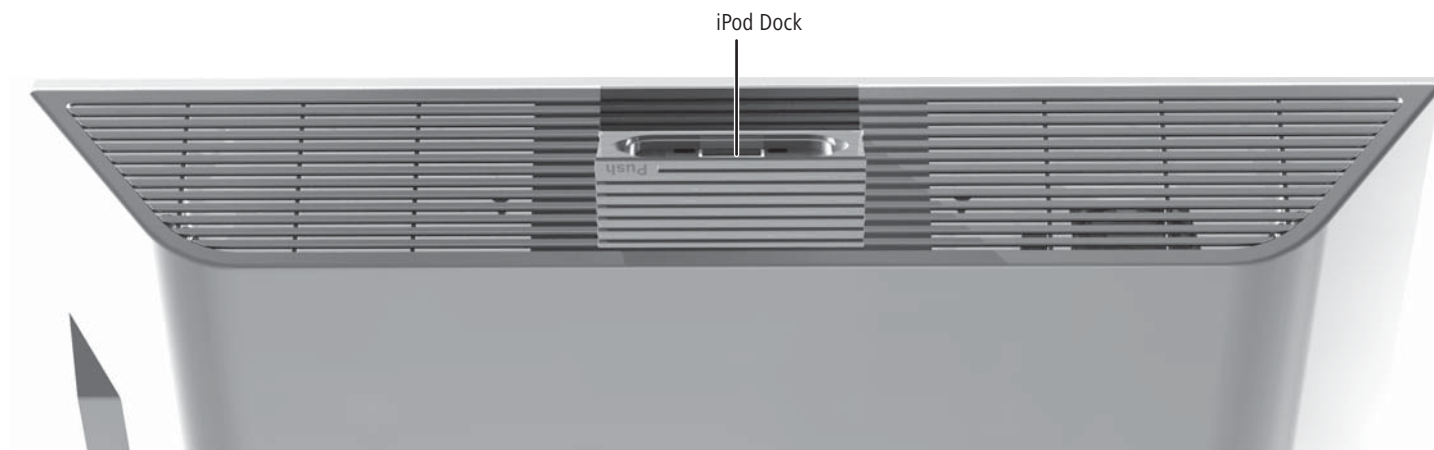
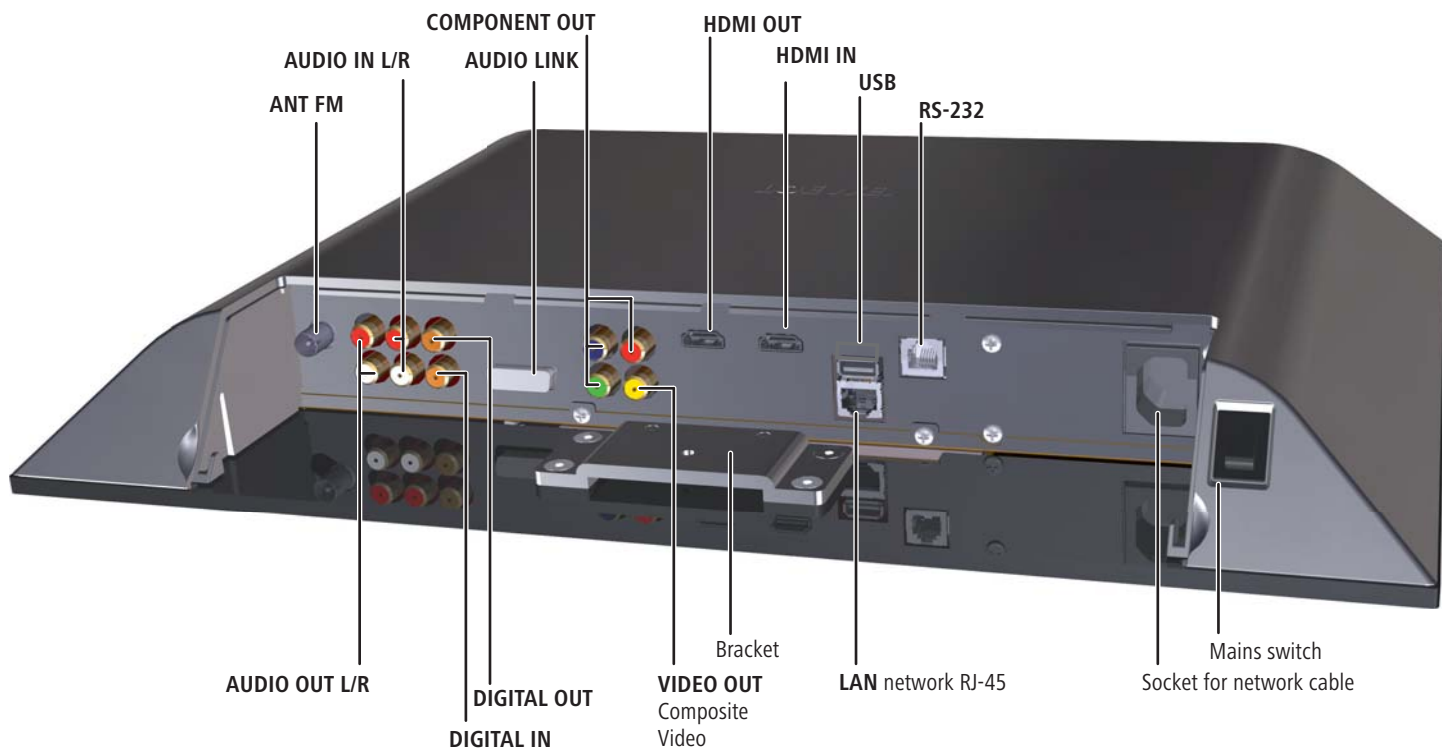

Welcome

Thank you

for choosing a Loewe product. We are happy to welcome you as our customer. At Loewe we combine the highest standards of technology, design and user friendliness. This is equally true of TV, DVD, video, audio and accessories. Neither technology nor design is an end in itself, but both are intended to provide our customers with the best possible audio and visual experience. Our design is not influenced by short-term, fashionable trends. You have, after all, purchased a high-quality piece of equipment which you do not want to tire of tomorrow or the day after.

Scope of delivery

- Individual Mediacyenter / DR+
- Assist Remote Control with 2 batteries
- Wall mount
- Antenna cable
- Network cable
- HDMI cable
- Mains cable
- Audio cable D-SUB/Cinch
- Self-adhesive spacer
- These operating instructions
- Assembly instructions

Operating requirements

To make optimum use of Loewe **Mediacyenter**, the following prerequisites must be satisfied:

- Connection to a wired(Ethernet, Powerline) or wireless (WiFi) home network, router with Internet access.
- Loewe TV set with HDMI input (from chassis L271x onwards) and current TV/DVB software.

Optional Expansions

- Loewe **Multiroom Receiver**.
- Loewe remote control of type Loewe **Assist Media**.
- Loewe TV set with HDMI input (from Mainframe L271x)
- Loewe Audio System
- Floor Stand Individual Mediacyenter, Art.No. 68281B00
- Table Stand Individual Mediacyenter, Art.No. 68280B00

Setup

- Please refer to the indications in the enclosed assembly instructions.
- Do not set up the unit near strong heat sources or in direct sunlight.
- When setting up in a cupboard or enclosed shelving: Leave at least 2.5 cm of free space around the unit to allow air to circulate freely and to prevent heat accumulation. Do not cover the fan and opening on the back.
- This device complies with the protection class 1. The power plug must be inserted in a socket with an earth wire connection.
- Incorrect voltages can damage the unit. The unit may only be connected to an electricity supply with the voltage and frequency stated on the rating plate and using the enclosed mains cable.
- During thunderstorms, disconnect the mains plug. A voltage surge caused by lightning conducted through the mains could damage the unit.
- If the unit is not to be used for an extended period, the plug should also be disconnected from the mains.
- The mains plug must be easy to reach to ensure that the unit can be disconnected from the mains at any time.
- Position the mains cable in such a way that it can not be damaged. The mains cable may not be bent or laid across sharp edges, walked on or exposed to any chemicals; the latter applies to the whole unit. A mains cable with damaged insulation can cause electric shocks and represents a fire hazard.
- When you want to unplug from the mains, pull on the plug housing rather than on the cable. The cables in the mains plug could otherwise be damaged and could cause a short-circuit when being plugged in again.
- Malfunctions can occur if there are other devices operating in the same frequency range (2.4 GHz) (see page 19).

Please also read and follow the safety advice on the following pages.

For your Safety

For your safety, and to avoid unnecessary damage to your unit, please read and follow the safety advice below. Please keep the safety information in a safe place.

Use for the intended purpose and ambient conditions

This unit is intended exclusively for wireless transmission and play of audio signals. It is designed for living or office rooms and may not be used in rooms with a high level of **humidity** (e.g. bathroom, sauna) or a high **dust concentration** (e.g. workshops).

The terms of the warranty only cover the intended use of the unit.

If the unit is used outdoors, make sure that it is protected from **moisture** (rain, drips, spray or dew).

High concentrations of moisture and dust lead to creepage current in the unit which can make it dangerous if a live wire is touched or it may cause a fire.

If you have moved the unit out of the **cold** into a warm environment, leave it switched off for about an hour to avoid the formation of **condensation**.

Always switch off your system (**Individual Mediacenter**, TV and any other components which may be connected) before connecting or disconnecting other devices or speakers.

Protect your device from:

- Water, dampness, dripping or sprayed water, steam.
- Knocks and mechanical stress
- Magnetic and electric fields
- Cold, heat, direct sunlight and high temperature fluctuations
- Dust
- Covers that inhibit ventilation
- Interference with the internal workings of the unit

Do not place any burning candles or anything filled with a liquid (such as vases) on the unit.

The ventilation slits on the back of the unit must not be covered with magazines or rugs. Pay attention for example to curtains etc.

This device is network-enabled. Please follow the instructions regarding the connecting options on pages 13-15 and 18.

Volume

Loud music can cause hearing damage. Avoid extreme volumes especially over extended periods of time and when using headphones.



IMPORTANT: TO AVOID RISK OF ELECTRIC SHOCK, DO NOT REMOVE THE COVER (AND THE BACK OF THE UNIT). THERE ARE NO PARTS INSIDE THE UNIT THAT CAN BE REPAIRED BY THE USER. REPAIRS SHOULD ONLY BE CARRIED OUT BY A LOEWE DEALER. Use only Original accessories and spare parts from Loewe.

Supervision

Do not allow **children** to use the unit/TV set unsupervised. Do not allow children to play in the immediate vicinity of the unit/TV set. Do not operate the Mediacenter unattended. If the unit is not to be used for an extended period, the plug should also be disconnected from the mains or switched off.

Cleaning

Only clean your unit with a slightly damp, soft, clean cloth (without any aggressive or scouring cleaning agents).

About these operating instructions

The information in this manual relates to the Loewe product **Individual Mediacenter**, or **Individual Mediacenter DR+**. Texts referring to the DR+ version are marked with the symbol: 

Unless stated otherwise, the instructions refer to the operating elements on the **Assist** remote control.

Paragraphs beginning with the  symbol indicate important hints, tips or conditions for perfect operation.

Terms which you will find in the menu or printed on the unit are printed in **bold type**.

In the functional descriptions, the necessary operating elements are arranged to the left of the text containing the handling instructions.

The diagrams in these operating instructions are only by way of example. The actual display may be different depending on the services available in your system.

Please do read the enclosed document to understand this device and its capabilities. The individual chapters are based on each other and therefore complement each other. Always follow the instructions for setting up, operation and security.

The keyword index/ glossary at the end of the manual explains certain terms used in the user interface of the device and its operating manual.

Performance

The **Loewe Individual Mediacenter / DR+** provides you a convenient access to your media collection. It plays CDs and DVDs and receives radio signals via antenna, cable, satellite or Internet. You can also use digital music files from your home network, USB stick and MP3 player as iPod or iPhone.

Connection options

2x USB 2.0
LAN RJ45 10/100/1000 Mbps
WiFi 802.11 b/g
HDMI In
HDMI Out
Video Composite Out
Video Component Out
Audio In
Audio Digital In
Audio Out
Audio Digital Out
Headphones 3.5 mm Stereo
FM antenna 75 Ohm
Loewe audio link
RS-232 RJ12 (for external home network systems)

CD/DVD Player

Slot-in disk drive
DVD Upscaling (720p/1080p)
Display of title, genre, album name, covers (if available)
Operation via touch-sensitive sensor buttons on the device as well as remote control
Streaming of audio content
Ripping of audio CDs **DR+**

Media management

DVD / CD identification through Internet databases
Storage of metadata of last 500 CDs
Storage of metadata of last 100 DVDs
Display of covers and title information on the TV screen
Display of ID3v1 and ID3v2 metadata
Recursive search in CD-R/RW discs for files and directories
Simple administration via TV screen menu
Creation and administration of playlists
Import of metadata from Internet
Import of audio CDs and storage on integrated harddisk **DR+**
Import/export of audio files and album graphics via PC and saving on the integrated hard disc **DR+**

Music Play

Play Audio CD, CD-R and CD-RW disc
Play MP3/VBR, WMA, FLAC, AAC audio files
Play playlists
Repeating Titles, Tracks or Directories
Shuffle

Streaming Server Connectivity+

UPnP-AV Audio Server
Audio streaming to up to 6 media receivers via LAN/WiFi
2 harddisks of 160 GB each with data security in RAID 1 system (mirror image) **DR+**

Party mode

Play an audio stream to several Loewe media receivers

FM Radio

FM radio with RDS display via cable or terrestrial means
Streaming of FM radio into home network

DVB Radio

DVB radio in compatible Loewe TV devices
Streaming of DVB radio into home network

Internet Radio

Supporting thousand radio stations via Internet radio
Support internet radio favourites list - can also be edited via the Loewe Portal

iPod Support

iPod Docking Station for iPod or iPhone (Airplane Mode)
Convenient control through Loewe Assist remote control
Battery charging

Use with other Loewe system components

Connection of Loewe Flat-TV sets via HDMI/CEC (from Mainframe L271x)
Connection of Loewe Audio Components via Audio Link

Setting up

Suggested setup solution: 5.1 Audio System

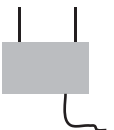
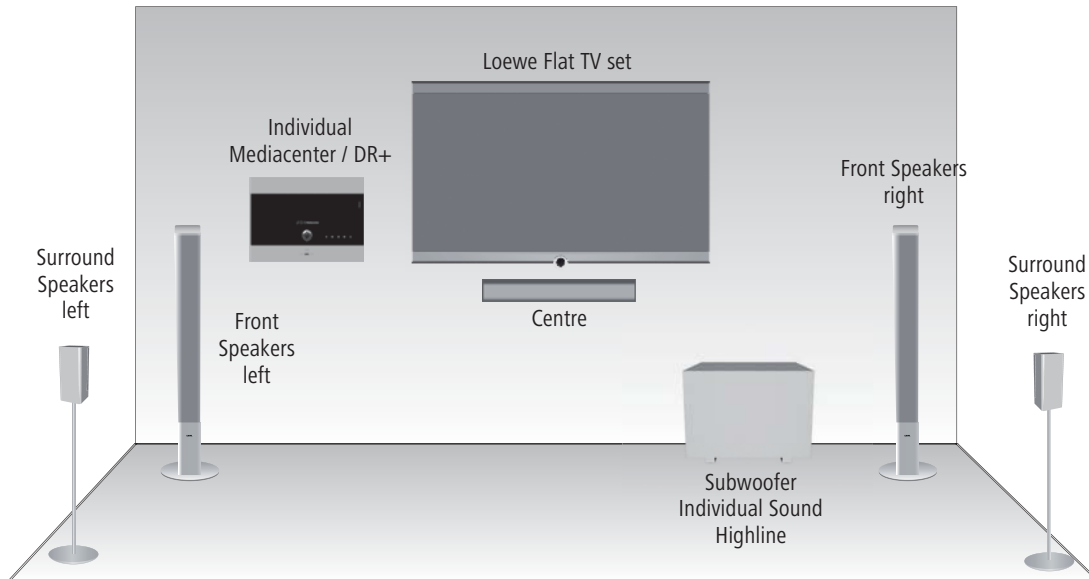

Internet Router

Suggested setup solution: Stereo Audio System

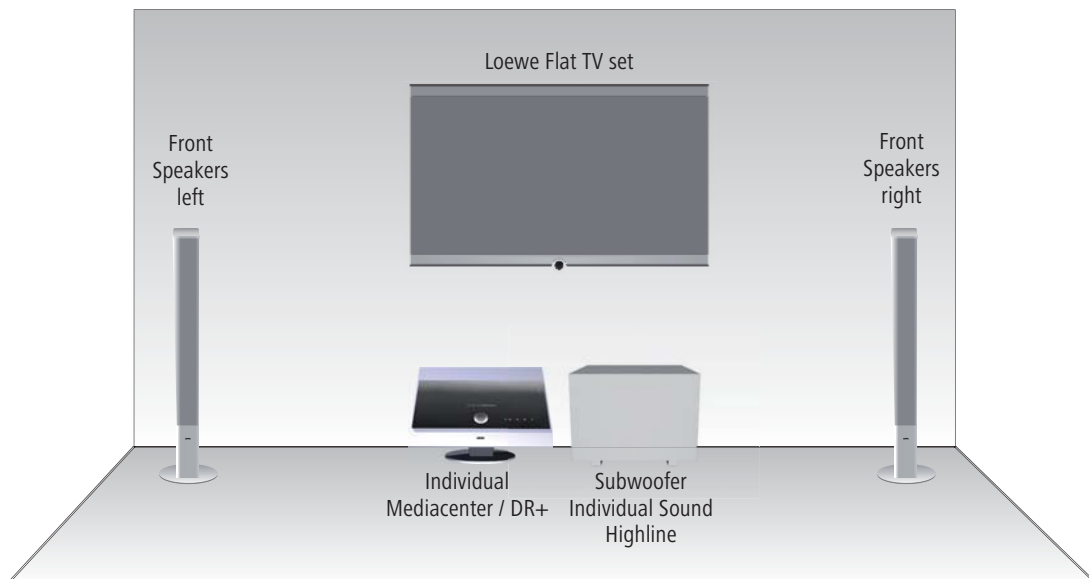

Setting up

Suggested setup solution: Multiroom System

Example: Living room

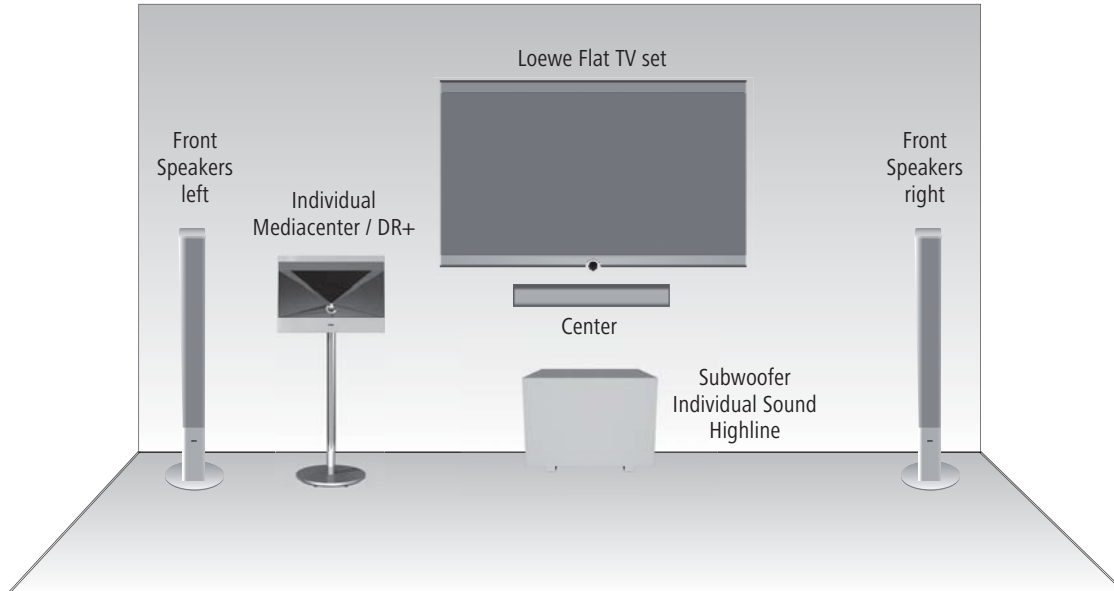

Example: Secondary room

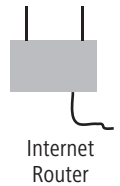
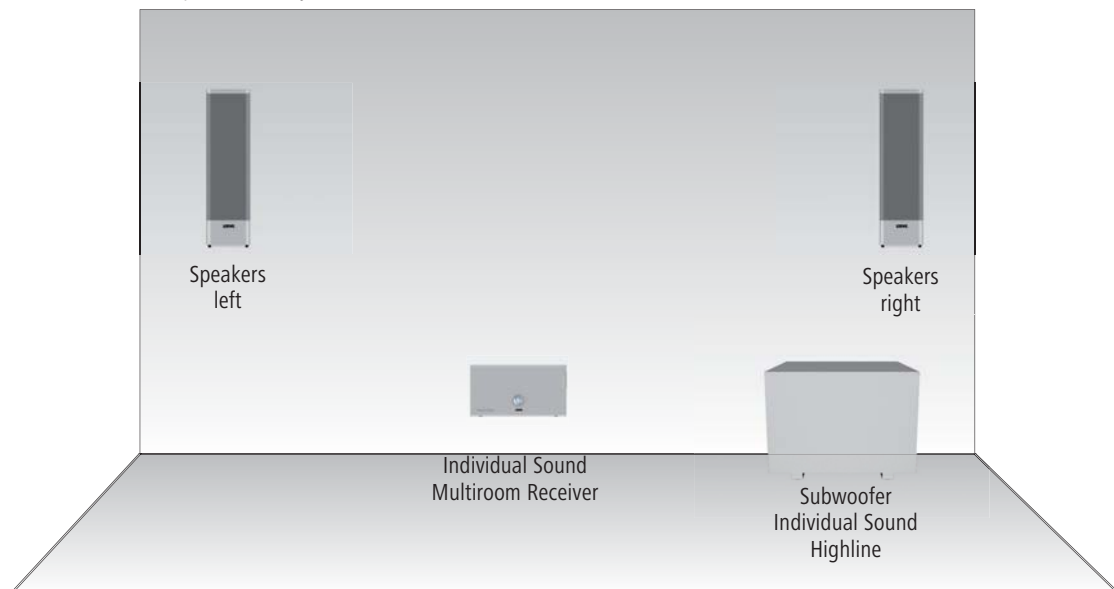

Connecting

Mediacenter in the integrated TV system

Use the supplied RJ-45 network cable to connect the **Mediacenter** to a network connection (e.g. switch or DSL router) with a link to the Internet.

Use the supplied HDMI cable to connect the **HDMI OUT** socket of the Mediacenter to the **HDMI IN** socket on your TV set.

If your TV set does not have an **HDMI IN** socket, use three video-capable cinch cables to connect the three **COMPONENT OUT** sockets of the Mediacenter to the **COMPONENT IN** sockets on your TV set.

Otherwise, using a cinch cable you can connect the **VIDEO OUT** socket on the Mediacenter with the **VIDEO IN** socket on your TV set. But through this connection, termed as **Composite Video**, you only receive a restricted picture quality. As far as possible, you should use the earlier mentioned connection types.

Using the supplied cinch cable (digital audio cable: socket in orange colour) connect the **AUDIO DIGITAL IN** socket of the Mediacenter with the cinch coupling of the D-SUB/Cinch audio cable. (Loewe Art.No. 70529.001).

Connect the **AUDIO LINK** socket of the TV set to the D-SUB coupling of the audio cable D-SUB/Cinch. You can connect a Loewe subwoofer available as an accessory at the other end of the D-SUB coupling.

In the menu **Sound components** (page 26), set the option **Sound via** on the **TV**. With the antenna cable, connect the **ANT FM** socket to an antenna socket. Plug the mains cable into a 220-240V 50/60 Hz wall socket.

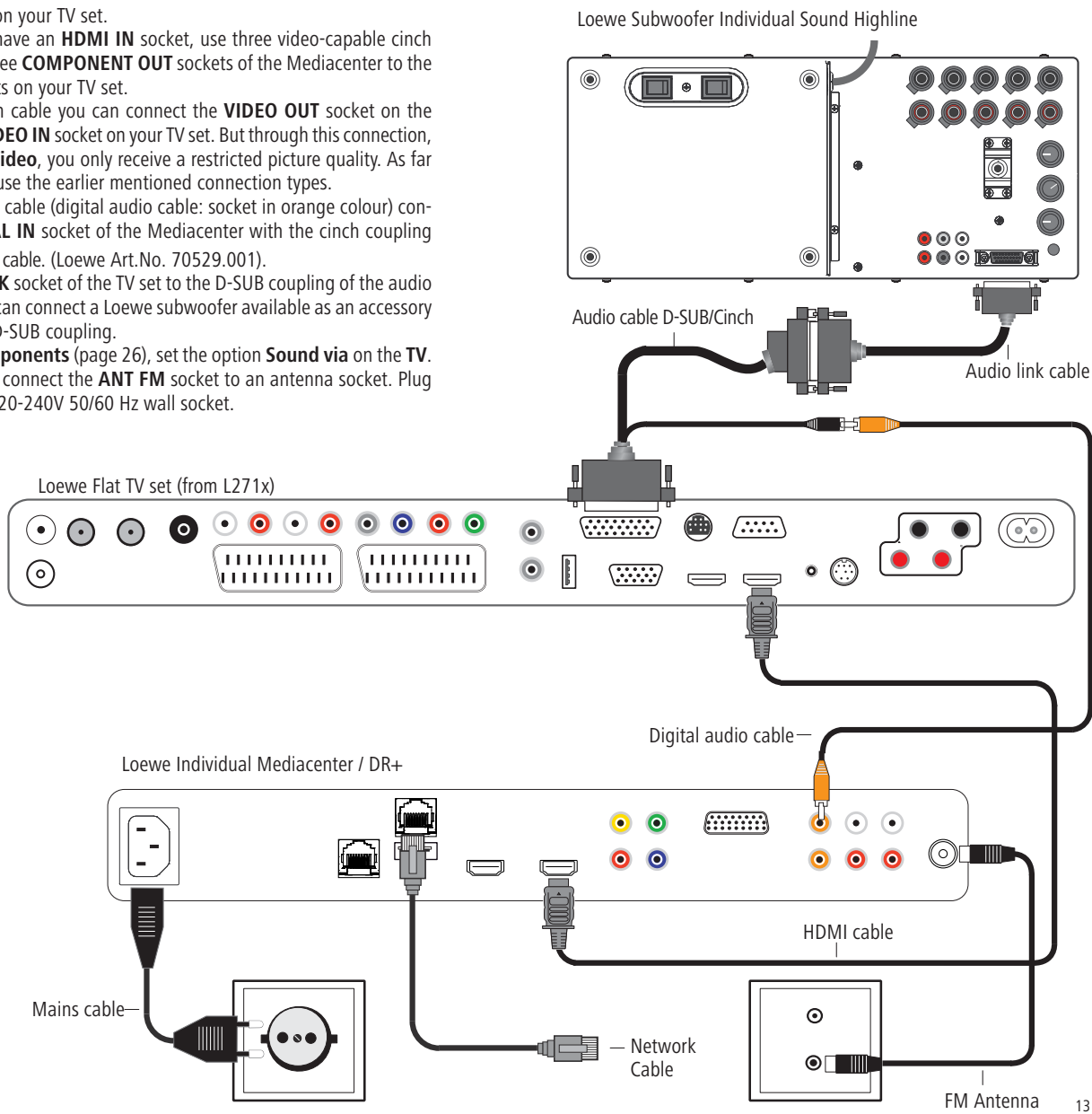

Connecting up

Mediacenter with Loewe Sound Projector and Loewe Flat TV Set

Use the supplied RJ-45 network cable to connect the **Mediacenter** to a network connection (e.g. switch or DSL router) with a link to the Internet.

Use the supplied HDMI cable to connect the **HDMI OUT** socket of the Mediacenter to the **HDMI IN** socket on your TV set.

Connect, using the supplied audio cable D-SUB/Cinch, the D-SUB plug with the socket **AUDIO-LINK** on the Loewe TV set.

Using the supplied cinch cable (digital audio cable: socket in orange colour) connect the **AUDIO DIGITAL IN** socket of the Mediacenter with the cinch coupling of the D-SUB/Cinch audio cable. (Loewe Art.No. 70529.001).

Connect the **AUDIO LINK** socket of the TV set to the D-SUB coupling of the audio cable D-SUB/Cinch. You can connect a Loewe subwoofer available as an accessory at the other end of the D-SUB coupling.

Use a cinch cable (digital audio cable: connector is orange in colour) to connect the **AUDIO DIGITAL OUT** socket of the TV set to the **TV-COAXIAL** socket of the **Sound Projector**.

In the menu **Sound components** (page 26), set the option **System amplifier** on the **TV**.

With the antenna cable, connect the **ANT FM** socket to an antenna socket. Plug the mains cable into a 220-240V 50/60 Hz wall socket.

Connect the sound projector to the TV set and subwoofer as shown.

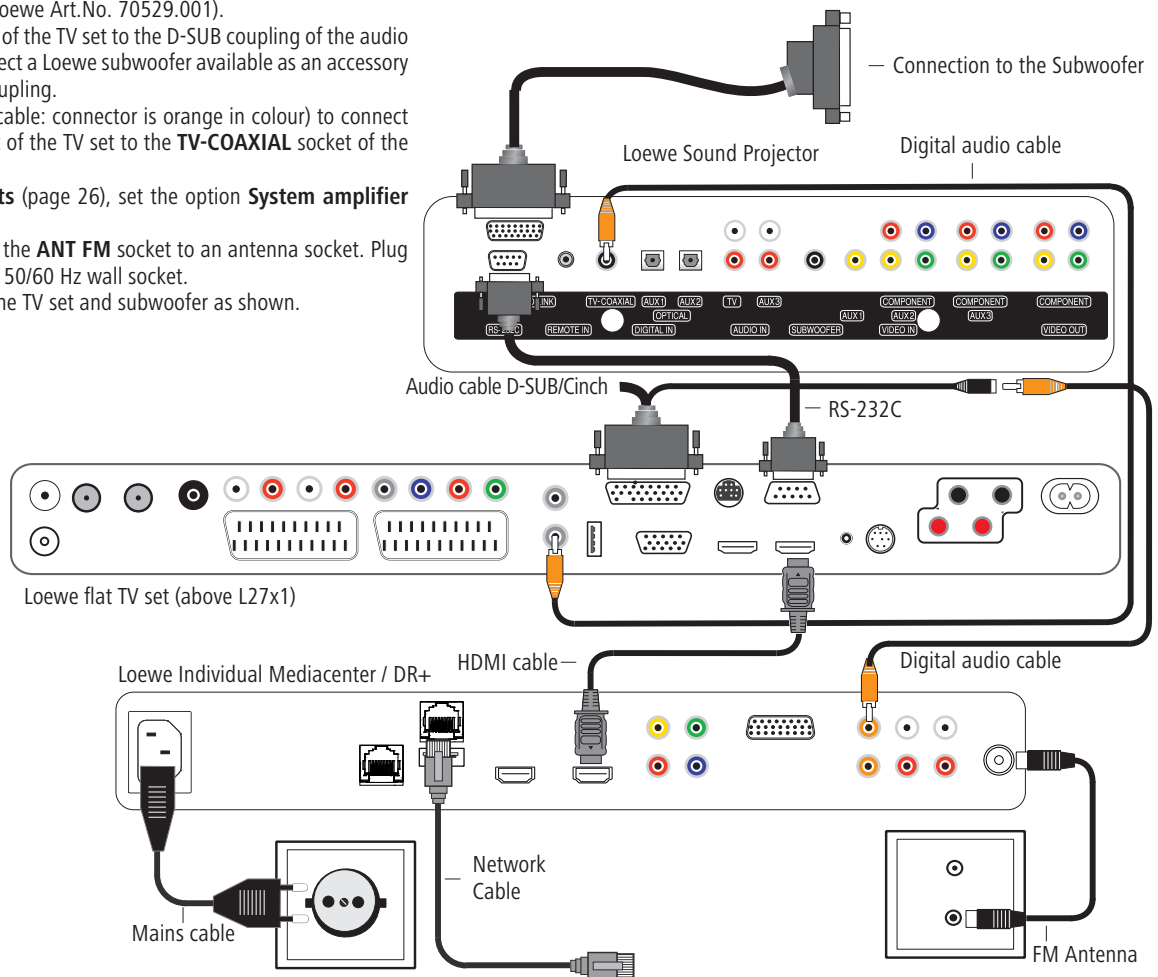

Connecting up

Mediacenter as a Standalone Solution

Use the supplied RJ-45 network cable to connect the **Mediacenter** to a network connection (e.g. switch or DSL router) with a link to the Internet.

- In order to be able to carry out settings (see from Page 18 onwards) it is necessary to connect the Mediacenter with a TV set (Page 13) in order to be able to operate the relevant menus. This is also recommended for operation of the Mediacenters.

Using the Audio Link Cable connect the **AUDIO-LINK** socket of the mediacenter to the **AUDIO-LINK** socket of the Loewe subwoofer.

In the menu **Sound components** (page 26) set the option **System amplifier** on the **Mediacenter**.

With the antenna cable, connect the **ANT FM** socket to an antenna socket. Plug the mains cable into a 220-240V 50/60 Hz wall socket.

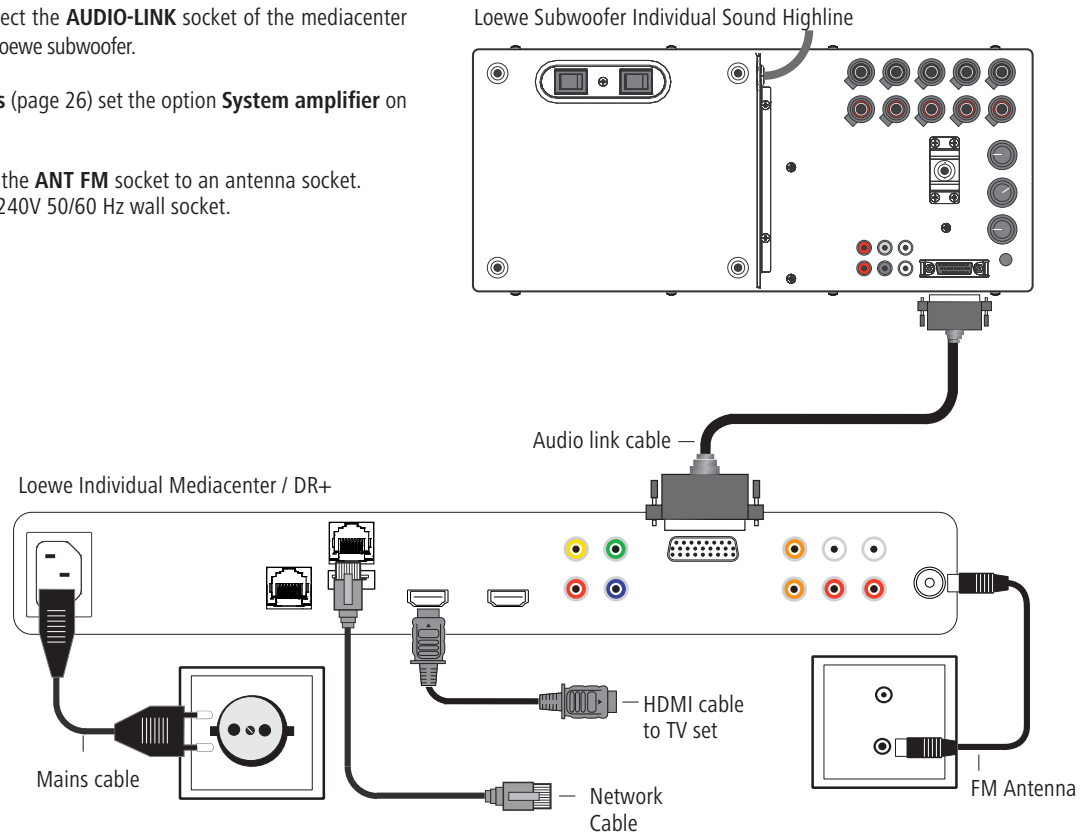

Start-up

Using the remote control for the first time



To insert or change the batteries, press on the arrow. While doing so, simply slide the battery compartment lid down and remove it. Insert alkali manganese batteries LR 03 (AAA) and ensure the correct position of + and -. Slide the cover on again from the bottom.

Setting up the Assist Remote Control

Other Devices

You can operate various Loewe devices using the **Assist** Remote Control. The device buttons **REC - BD - AUDIO** can be set up for this.

BD Press the required device buttons and the Stop button simultaneously for 5 sec. until the corresponding LED display flashes twice.

Then select the two-digit device code from the table:

Unit	Code	Restore defaults
Loewe ViewVision 8106 H	10	
Loewe ViewVision, Centros 21x2	12	
Loewe ViewVision DR+ DVB-T	13	REC
Loewe Auro 2216 PS/8116 DT	14	
Loewe BlutechVision	15	
Loewe Sound Projector 1	17	
Loewe TV Radio digital	19	
Loewe Mediacenter	20	AUDIO
Loewe BlutechVision Interactive	21	BD
HDMI CEC Mode **	22	
Loewe AudioVision	24	
Loewe Sound Projector SL	25	
Restore defaults	99	

The corresponding LED Display flashes twice.

Sound functions

It is possible to set the devices with which the buttons with the sound functions (**V+/-**, **Mute** and **sound mode**) should work. Depending upon which device configuration you use (page 13- page 15), set the device keys and sound functions of the **Assist** remote control. If you use the integrated network configuration as described on page 13, the Loewe TV set will process the sound and the sound functions of the **Assist** remote control do not have to be changed. With a configuration as described on page 14 and page 15, it is necessary to change the sound functions on the **Assist** remote control as described below.

TV **4** ghi Press the device button **TV** and at the same time the button with the single digit function code from the list for 5 sec. until the LED Display flashes twice.

Function	Code	Figure
Loewe AudioVision	3	
Loewe Mediacenter	4	Page 15
Loewe TV *	5	Page 13 / Page 14
Loewe Sound Projector	6	

* Restore defaults

** From mainframe L271x, Software ≥ V9.16

Operating Loewe Equipment

Using the remote control for a Loewe TV set

TV Press **TV** button; the LED Display above it lights up for approx. 5 seconds

Using the remote control for a Loewe recorder

REC Press the **REC** button; the LED Display above it lights up for approx. 5 seconds

Using the remote control for BluTechVision Interactive

BD Press the **BD** button; the LED Display above it lights up for approx. 5 seconds

Using the remote control for Mediacenter

AUDIO Press the **AUDIO** button; the LED Display above it lights up for approx. 5 seconds

Every time a button is pressed, the LED display lights up for the selected operating mode for checking purposes (**TV - REC - BD - AUDIO**). Please refer to the respective operating conditions on how to operate the individual devices.

Start-up

Connecting to the Mains Supply

Make the required cable connections as described in section "Connecting" (page 13). First insert the smaller three-pin plug of the network cable into the socket for the network cable (page 7) at the rear of the player, then insert the large network plug into a 220-240V/50-60 Hz network socket.

Switching On/Off

- ➡ Please switch your Mediacyter after the first boot process (it can take a few minutes) IN FUTURE ONLY switch on and off by pressing briefly of the on/off button on the remote control. Your Mediacyter remains ready for use more quickly in this way.

Switch on the **Mediacyter** with the **Mains switch** (page 7).

AUDIO

Adjust the remote control for **Mediacyter** operation by briefly pressing the **AUDIO** button.

Your **Mediacyter** switches on. If you have connected a Loewe TV set (from L271x) via HDMI, then this will switch on as well. Otherwise, switch your TV set on and set the respective AV programme slot.



To switch off the device, press the On/Off switch on your **Mediacyter** (page 6) or **Assist** (page 3) remote control.

- ➡ To prevent loss of data, do not switch off until all write operations (e.g. reading from USB memory or iPod, CD import) on the harddisks **DR+** have ended.

While the **Mediacyter** starts up, the red **LED indicator** flashes (page 6).

The moment the **Mediacyter** becomes operational, the green **LED indicator** begins to glow constantly.

- ➡ If available, a software update for the Mediacyter is automatically started after **Product registration** (on this page) and setting up of Internet access (from page 19) after confirmation (page 31).
- ➡ Switch your **Mediacyter** off if you are to be away for an extended period, first with the **On/Off** Button and then with the mains switch or pull out the mains plug. This will save energy and protect the environment.

Digital Link HD (HDMI CEC)

With the Digital Link HD, the Loewe TV sets (above chassis L271x) pass on the remote control signals over the HDMI link from the Loewe TV set to the compatible attachments, such as e.g. **Mediacyter**. Digital Link HD is useful if you want a concealed setup for the **Mediacyter** and the device is completely controlled via Loewe TV set.

First of all, adjust the HDMI CEC function for the **Assist** remote control as described on page 16 to Code 22 on the required device button (e.g. AUDIO).

Then carry out the allocation of the Digital Link HD function to the HDMI interface of the TV set used by pressing the button set above (e.g. AUDIO) for 5 sec.

A selection menu will appear.

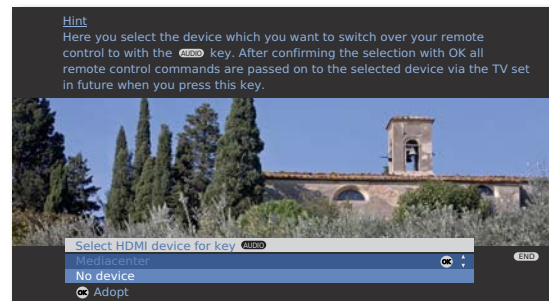

- ▲ ▼ Select the desired device (e.g. **Mediacyter**).

Confirm **OK**.

Now, the signals from the **Assist** remote control of the Loewe TV set are transmitted to the **Mediacyter** if the relevant device button (e.g. BD) is pressed beforehand.

- ➡ It is possible that your Loewe TV set may need a software update. Please contact your specialist retailer.

Product Registration

The **Mediacyter** must be registered once during startup to be able to use all integrated services.

In accordance with § 33 of the German Federal Data Protection Act (BDSG) we would like to highlight that the device number and the respective software version are processed and saved using electronic data processing equipment. The data guarantee that we are always able to provide you with the best service in the event of any repairs. All information is treated as confidential and not passed on to the third parties.

Start-up

Main Menu

The menu of the **Mediacenter** is displayed on the screen of the connected TV set. From here, you can execute different functions of the **Mediacenter** and also make the necessary settings.

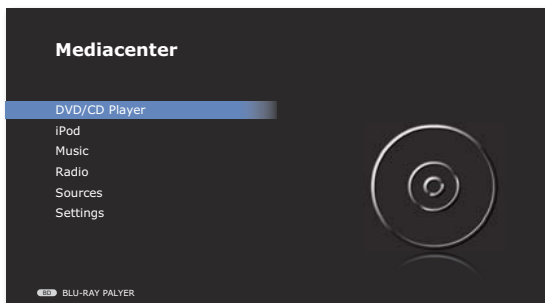

Navigation in the Menu

In these operating instructions, the arrow buttons on the Remote Control Assist are shown as follows:



In the text, the arrows correspond to: "▲▼◀▶".
The OK button on the remote control is shown as **OK** in the text.



Call up Main Menu.

▲▼▶ Select required option.

◀ Move Back in the menu.



Move Back in the menu.

Confirm **OK**.



Push the button **BD** to operate a **BluTechVision Interactive** player connected to the Loewe TV set..

Settings Menu

Set the **Mediacenter** to meet your individual requirements and configuration.



▲▼ Select **Settings** option.

Confirm **OK**.



Calling up menu settings directly from other menus.

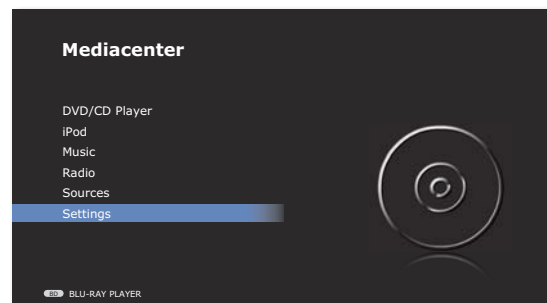

▮▮▮ If necessary, set the TV resolution as described on page 28 to have a better TV screen display.

Menu Language

Select a language for menus and dialogues displayed by the player.



Call up Main Menu.



▲▼ Select **Settings** option.

Confirm **OK**.

▲▼ Select **Language** option. Confirm **OK**.

▲▼ Select **On Screen User Interface** option. Confirm **OK**.

▲▼ Select required language. Confirm **OK**.

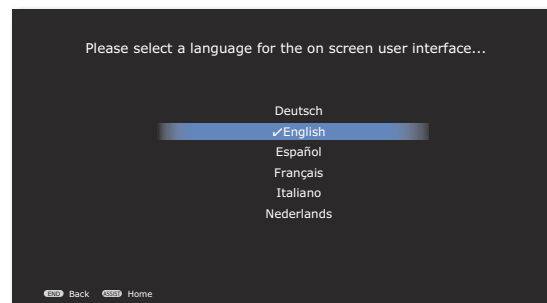

Call up Main Menu.

Start-up

Network

Different settings must be made depending upon whether the **Mediacenter** has a Depending on whether you use a wired (Ethernet, Powerline) or wireless (WiFi) connection with your home network several settings will have to be made.

- Loewe recommends use of a wired network (Ethernet, Powerline) to ensure a high stability and quality of the data link. Use a wireless connection only if there is no option. As a matter of principle, wireless connections can get disturbed due to external influences (e.g. microwave devices) and mostly provide a lower data transmission rate.

Wired network

Here you make the settings for the selected network.



Call up Main Menu.

▲ ▼ Select **Settings** option.

Confirm **OK**.

▲ ▼ Select option **Network**.

Confirm **OK**.

▲ ▼ Select **Connect Using** option.

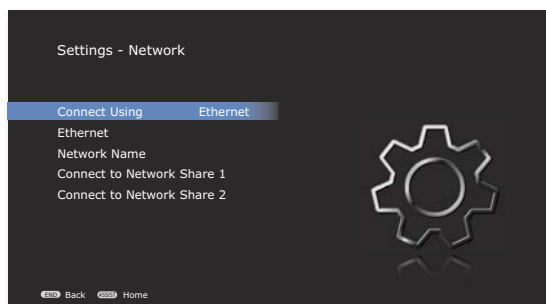

OK several times to set the **Ethernet** option.

IP Address Type DHCP

If a DHCP server is present in your home network (e.g. a DSL router), use this setting since all network parameters are set automatically.



Call up menu as under "Wireless network".

▲ ▼ Select **Set Ethernet** option.

Confirm **OK**.

▲ ▼ Select **IP address type** option.

▶ Press several times to set the **DHCP** option.

▼ ▲ Select **Test settings** option.

Confirm **OK**.

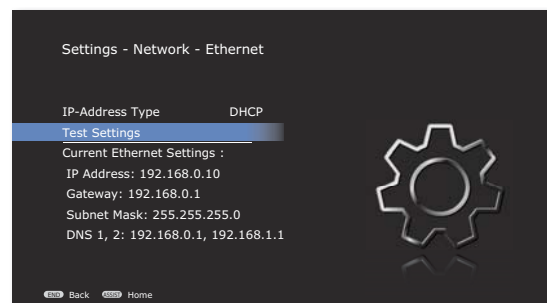

Now, an automatic test run starts, during which all settings relevant for the flawless operation of the Mediacenter are tested. A report is outputted on the screen during the execution of the text.



The network setting is successfully complete when all tests are over and indicate an **OK** status.

Call up Main Menu.



Start-up

IP Address Type Manual

The network parameters be fixed manually (e.g. when there is no DHCP server in your home network).



➡ Call up menu as under "Wireless network".

▲ ▼ Select **Set Ethernet** option.

Confirm **OK**.

▲ ▼ Select **IP address type** option.

▶ Press several times to set the **Manual** option.

▼ ▲ Select option **IP Address Settings**.

Confirm **OK**.

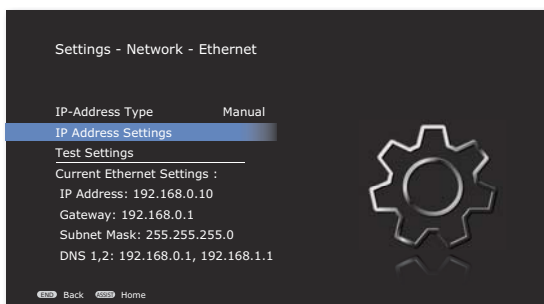

▼ ▲ Select desired option, e.g. **IP Address**.

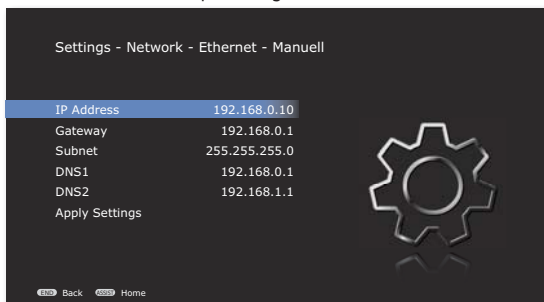

Confirm **OK**.

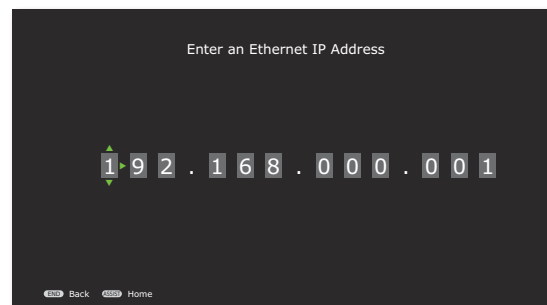

▼ ▲ Select digit.

◀ ▶ Select position.

Confirm **OK**.

When all network parameters are set correctly:

Move **Back** in the menu.

▼ ▲ Select **Test settings** option.

Confirm **OK**.

Now, an automatic test run starts, during which all settings relevant for the flawless operation of the Mediacenter are tested. A report is outputted on the screen during the execution of the text.

END

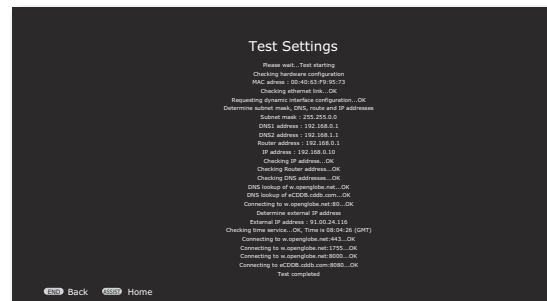

The network setting is successfully complete when all tests are over and indicate an OK status.

▼ ▲ Scroll up/down the report.

Call up **Main Menu**.

ASSIST

Start-up

Wireless network

Here you make the settings for the selected network.

ASSIST



Call up Main Menu.

▲ ▼ Select **Settings** option.

Confirm **OK**.

▲ ▼ Select option **Network**.

Confirm **OK**.

▲ ▼ Select **Connect Using** option.



OK several times to set the **WiFi** option.

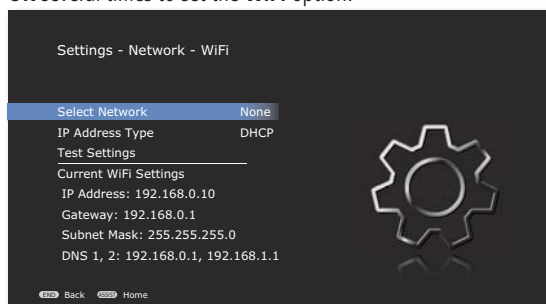

▼ ▲ Select **WiFi** option.

Confirm **OK**.

▼ ▲ Select **Network** option.

Confirm **OK**.

▼ ▲ Select **WiFi network** option.

Confirm **OK**.

The available wireless networks in the vicinity are searched and shown in a list for selection.

➡ The encryption as per the standard WEP is no longer considered safe. If possible, use the standards WPA or WPA2. Please make the appropriate settings in your WiFi router.



▼ ▲ Select desired wireless network.

Confirm **OK**.

➡ If your wireless network is encrypted, then it is necessary to enter the WiFi password that allows access to the network.

➡ The WiFi password must have a minimum of 8 characters and a maximum of 64 characters. Mutated vowels (umlauts) are not supported.

➡ If you do not know the WiFi password, contact your network administrator.

Enter the **Network password** from the menu (as described under "Mediacenter Network Name" on page 22).

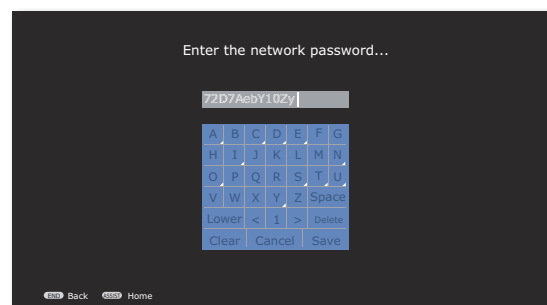

Start-up

Mediacenter Network Name

The Mediacenter registers itself as a server in your home network with the name **Mediacenter**. Alternately, you can enter the name of your choice. This name must not exceed 15 characters (no special characters or spaces).

ASSIST

Call up Main Menu.



▲ ▼ Select **Settings** option.

Confirm **OK**.

▲ ▼ Select option **Network**.

Confirm **OK**.

▲ ▼ Select **Mediacenter Network Name** option.

Confirm **OK**.

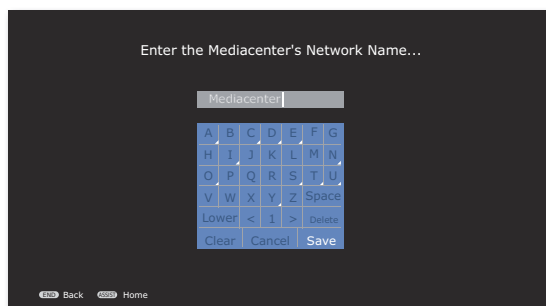

▲ ▼ ◀ ▶ Select alphabets / digits / function.

Confirm **OK**.

Capital Letters in uppercase

Small Letters in lowercase / special characters

Other Special characters

◀▶ / ▶▶ Country-specific special characters

Space Spaces

</> Select a digit between 0-9

Delete Delete a character to the left of the cursor

Clear Completely delete the input field

Cancel Close menu without saving

Save Save entry and close menu

Network Share

With the **Mediacenter**, you can access up to two CIFS/SMB Network Shares in your home network. Media stored in these directories (e.g. NAS harddisks) can be played back locally on the **Mediacenter** or streamed to the **Multiroom Receivers** or streaming clients in your home network.

- ▶▶▶ To enter the network path, either the "Name" of the drive with at least one enabled folder. If the Network Share cannot be addressed with this name, please use the IP Address of the Network Share.

ASSIST

Call up Main Menu.



▲ ▼ Select **Settings** option.

Confirm **OK**.

▲ ▼ Select option **Network**.

Confirm **OK**.

▲ ▼ Select option **Connect with network drive 1/2**.

Confirm **OK**.

Enter the complete network path in the text input menu (as described on this page under "Mediacenter Network Name").

Example: //Diskstation/music

- ▶▶▶ After a successful connection, the medium is automatically "indexed" for subsequent convenient and quick search of music. This process can take longer depending upon the size of the music collection.

Start-up

Reduced Power Down

With the function Reduced Power Down, you can save maximum energy (see page 57). It will however take somewhat longer to switch on the device.



Call up Main Menu.

▲ ▼ Select **Settings** option.

Confirm **OK**.

▲ ▼ Select option **Reduced Power Down**.

Confirm **OK**.

▲ ▼ Select option **Reduced Power Down**.

Confirm **OK**.

▮ A Loewe TV set connected via HDMI cannot be automatically switched on by a **Mediacenter** in "Reduced Power Down" via the AV selection facility.

Standby Timer

With the standby timer, you can set that the Mediacenter switches off automatically (without user intervention) after a time set by you.



Call up Main Menu.

▲ ▼ Select **Settings** option.

Confirm **OK**.

▲ ▼ Select option **General**.

Confirm **OK**.

▲ ▼ Select option **Standby Timer**.

Confirm **OK**.

▲ ▼ Select option **1 - 60 minutes / never**.

Confirm **OK**.

Screen Saver

A screen saver animation can be set.



Call up Main Menu.

▲ ▼ Select **Settings** option.

Confirm **OK**.

▲ ▼ Select option **General**.

Confirm **OK**.

▲ ▼ Select option **Screen saver**.

Confirm **OK**.

▲ ▼ Select option **1 - 60 minutes / never**.

Confirm **OK**.

Automatic Return to Play

The time, up to which the "Now Playing" menu is displayed, can be set.



Call up Main Menu.

▲ ▼ Select **Settings** option.

Confirm **OK**.

▲ ▼ Select option **General**.

Confirm **OK**.

▲ ▼ Select option **Automatic return to play**.

Confirm **OK**.

▲ ▼ Select option **5 - 60 seconds / never**.

Confirm **OK**.

Time Zone

The time zone, in which the **Mediacenter** is operated, can be set.



Call up Main Menu.

▲ ▼ Select **Settings** option.

Confirm **OK**.

▲ ▼ Select option **General**.

Confirm **OK**.

▲ ▼ Select option **Time zone**.

Confirm **OK**.

▲ ▼ Select option **GMT -12:00 ... +11:00**.

Example for Central Europe: +1:00 (Normal time)

Example for Central Europe: +2:00 (Summer time)

Confirm **OK**.

Privacy Policy

Important instructions regarding data security can be accessed from here.



Call up Main Menu.

▲ ▼ Select **Settings** option.

Confirm **OK**.

▲ ▼ Select option **General**.

Confirm **OK**.

▲ ▼ Select option **Privacy Policy**.

Confirm **OK**.

Start-up

Movie Audio

You can set the sound format for the digital audio output in DVD mode.

ASSIST



Call up Main Menu.

▲ ▼ Select **Settings** option.

Confirm **OK**.

▲ ▼ Select option **Audio**.

Confirm **OK**.

▲ ▼ Select option **Movie**.

Confirm **OK**.

▲ ▼ Select desired option.

5.1 Channel Surround Output of 5.1 Channel Surround Sound. Use this option if you use a 5.1 audio system (home theatre system).

Two channel stereo-Downmix Output of two channel stereo sound. 5.1 Surround Sound is converted by the **Mediacenter** into stereo sound.

Confirm **OK**.

Sound mode

You can enter the number of speakers connected to the **Mediacenter**. Use this option, if you operate the **Mediacenter** as a standalone solution (page 15)

ASSIST



Call up Main Menu.

▲ ▼ Select **Settings** option.

Confirm **OK**.

▲ ▼ Select option **Audio**.

Confirm **OK**.

▲ ▼ Select option **Sound mode**.

Confirm **OK**.

▲ ▼ Select option **optimum / 1 - 5 speakers**.

Confirm **OK**.

Dolby Pro Logic II Mode

You can set the sound format for the analog stereo audio signal in the Dolby-Pro Logic II mode for surround playback. Use this option, if you operate the **Mediacenter** as a standalone solution (page 15)

ASSIST



Call up Main Menu.

▲ ▼ Select **Settings** option. Confirm **OK**.

▲ ▼ Select option **Audio**. Confirm **OK**.

▲ ▼ Select option **Dolby Pro Logic II Mode**.

Confirm **OK**.

▲ ▼ Select desired option.

Movie Adjustment optimised for film sound play with emphasis on the central channel

Music Adjustment optimised for music play with emphasis on the external channels.

In the **Custom Settings** sub-menu you can carry out individual setting of the level and base width of the channels

Matrix Simultaneous sound play on all channels.

Confirm **OK**.

Sound Adjustment

You can select sound play from different sound settings or use your own settings. Use this option, if you operate the **Mediacenter** as a standalone solution (page 15).

ASSIST



Call up Main Menu.

▲ ▼ Select **Settings** option.

Confirm **OK**.

▲ ▼ Select option **Audio**.

Confirm **OK**.

▲ ▼ Select option **Sound adjustment**.

Confirm **OK**.

▲ ▼ Select desired option.

Off No special sound setting is made

Language The sound play is optimised for the language

Classic The sound play is optimised for the classical music

Pop The sound play is optimised for the pop music

Pers. Music mode You can make two own sound settings
Pers. Cinema mode and select one actively

Confirm **OK**.





Set bass and treble

Start-up





Loudness

You can set an aurally compensated increase in higher and deeper sounds depending upon the volume. Set this option to **On**, if you operate the **Mediacenter** as a standalone solution (page 15).

-  Call up Main Menu.
-  ▲ ▼ Select **Settings** option.
- Confirm **OK**.
- ▲ ▼ Select option **Audio**.
- Confirm **OK**.
- ▲ ▼ Select option **Loudness**.
-  Select option **On / Off**.

Max Volume



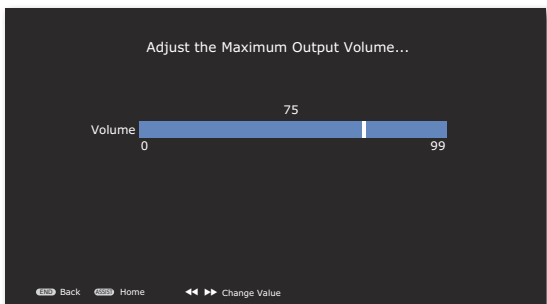

You can set the maximum adjustable volume. Use this option, if you operate the **Mediacenter** as a standalone solution (page 15).

-  Call up Main Menu.
-  ▲ ▼ Select **Settings** option.
- Confirm **OK**.
- ▲ ▼ Select option **Audio**.
- Confirm **OK**.
- ▲ ▼ Select option **Max Volume**.
- Confirm **OK**.
-  Set desired **Maximum Output Volume**.
-  Move Back in the menu.







Switch On Volume

You can specify here the volume to be set after the **Mediacenter** is started up. Use this option, if you operate the **Mediacenter** as a standalone solution (page 15).

-  Call up Main Menu.
-  ▲ ▼ Select **Settings** option.
- Confirm **OK**.
- ▲ ▼ Select option **Audio**.
- Confirm **OK**.
- ▲ ▼ Select option **Switch On Volume**.
- Confirm **OK**.
-  Set desired volume.
-  Move Back in the menu.

Night mode

With this setting you can limit the dynamics (this means the difference between the loudest and the quietest sounds). You can thus also play back a movie with smaller volume differences.

-  Call up Main Menu.
-  ▲ ▼ Select **Settings** option.
- Confirm **OK**.
- ▲ ▼ Select option **Audio**.
- Confirm **OK**.
- ▲ ▼ Select option **Night mode** .
-  Select option **On / Off**.
-  Move Back in the menu.

Start-up

Sound Components

In this menu you can configure your audio system.

ASSIST

Call up Main Menu.



▲ ▼ Select **Settings** option.

Confirm **OK**.

▲ ▼ Select option **Audio**.

Confirm **OK**.

▲ ▼ Select option **Sound components**.

Confirm **OK**.

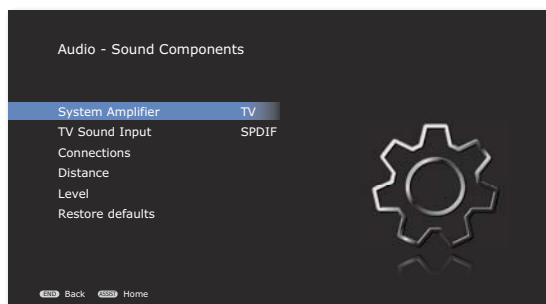

System amplifier

Depending upon whether you operate the **Mediacenter** as a compound system with a Loewe TV set (page 13 and page 14) or as standalone solution (page 15), with this option you can set which system is to be used to process the audio signals.

▣ Call up menu as under "Sound components".

▲ ▼ Select option **System amplifier**.

▶ Select desired option.

TV The audio signals are processed by the Loewe TV set.
Make the sound settings in the TV set.

Mediacenter The audio signals are processed by the **Mediacenter**.
The sound settings in the menu **Settings - Audio** are applicable.

▣ Loewe recommends using the Loewe TV set (from chassis L271x onwards) as the system amplifier. If you connect the Mediacenter via an HDMI interface, operation will be simpler since the compatible units can be automatically switched on/off.

TV Sound Input

If you operate the **Mediacenter** as a standalone solution (page 15), use this option to set whether the audio signal (e.g. of a connected TV set) is outputted as an analogue or a digital signal.

▣ Call up menu as under "Sound components".

▲ ▼ Select option **TV sound input**.

▶ Select desired option.

SPDIF The digital audio signal at the socket **DIGITAL IN** of the **Mediacenter** is processed.

Line In The analogue stereo audio signal at the sockets **AUDIO IN L/R** of the **Mediacenter** is processed.

END

Move Back in the menu.

Start-up

Connections

When you operate the **Mediacenter** as a standalone solution (page 15), use this option to set which speakers are connected.

▣ Call up menu as under "Sound components".

▲ ▼ Select option **Connections**.

Confirm **OK**.

▲ ▼ Select desired option.

Confirm **OK**.

Front speaker Set to ◀ ▶ **No** or cut-off frequency between **10 ... 200 Hz**

Center Speaker Set to ◀ ▶ **No** or cut-off frequency between **10 ... 200 Hz**

Surround Speakers Set to ◀ ▶ **No** or cut-off frequency between **10 ... 200 Hz**

Subwoofer Set to ◀ ▶ **No** or **Yes**.

END Move Back in the menu.

Distances

When you operate the **Mediacenter** as a standalone solution (page 15), use this option to set the distance of the speakers from the listening position.

▣ Call up menu as under "Sound components".

▲ ▼ Select option **Distances**.

Confirm **OK**.

▲ ▼ Select speaker.

Confirm **OK**.

◀▶ Set distance between 0.10 m ... 10.00 m.

END Move Back in the menu.

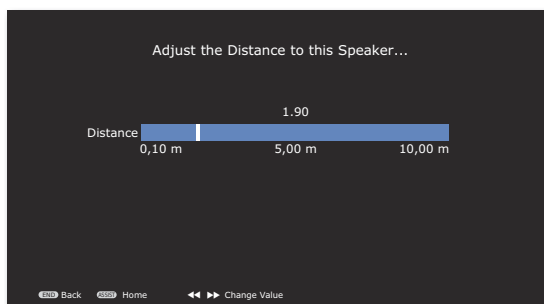

Level

When you operate the **Mediacenter** as a **System amplifier** (page 15), you can set each speaker such that it is heard at the same volume at your listening position.

▣ Call up menu as under "Sound components".

▲ ▼ Select option **Level**.

Confirm **OK**.

▲ ▼ Select speaker.

Confirm **OK**.

◀▶ Set volume level between -12 dB ... +12 dB.

▶ Start automatic playing of speakers.

■ Stop automatic playing of speakers.

END Move Back in the menu.

Restore defaults

You can reset all settings related to the sound components to the factory set values.

▣ Call up menu as under "Sound components".

▲ ▼ Select option **Restore defaults**.

Confirm **OK**.

▲ ▼ Select option **Yes / No**.

Start-up

TV Resolution

In this menu you can set the TV Resolution. Higher resolution provides a sharper screen display.

- ➡ Please refer to the documentation of your TV set to learn about the resolutions supported by your TV set at the used video socket.

Depending upon which interfaces do you use for the Video link to the TV set, specific resolutions are required:

HDMI 576i/p, 720p 50/60 Hz, 1080p 50/60 Hz

Component 576i/p

Composite 576p



Call up Main Menu.

- ▲ ▼ Select **Settings** option.

Confirm **OK**.

- ▲ ▼ Select option **Video**.

Confirm **OK**.

- ▲ ▼ Select option **TV Resolution**.

Confirm **OK**.

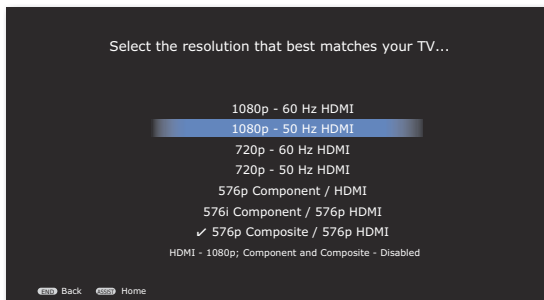

- ▲ ▼ Select desired resolution.

Confirm **OK**.

The screen resolution is set to the selected option.

At the same time, it is inquired whether the selected resolution should be retained.

- ▲ ▼ Select **Yes** if the display is flawless.

Confirm **OK**.

If the display is unsatisfactory or there is no image to be seen, press **OK** to switch back to the previously selected resolution.

TV Type

You can set here the colour-encoding system to be used for the video output on your TV set.



- ➡ Please refer to the documentation of your TV set to learn about the colour-encoding system supported by your TV set.

Call up Main Menu.

- ▲ ▼ Select **Settings** option.

Confirm **OK**.

- ▲ ▼ Select option **Video**.

Confirm **OK**.

- ▲ ▼ Select option **TV type**.

Confirm **OK**.

NTSC American colour-encoding system

PAL European colour-encoding system (recommended)

- ▲ ▼ Select desired option.

Confirm **OK**.

DVD Playback Frequency

This option defines whether the **Mediacenter** should (**automatically**) scale the DVD signal or whether this will be done by the TV set.



Call up Main Menu.

- ▲ ▼ Select **Settings** option.

Confirm **OK**.

- ▲ ▼ Select option **Video**.

Confirm **OK**.

- ▲ ▼ Select option **DVD Playback Frequency**.

Confirm **OK**.

Automatic The TV screen refresh rate is adjusted to the DVD specified value

TV Type The TV screen refresh rate depends on the TV set

- ▲ ▼ Select desired option.

Confirm **OK**.

Start-up

HDMI Settings

For the HDMI interface to the TV set, a few parameters can be set for the optimum operation.

ASSIST

Call up Main Menu.



▲ ▼ Select **Settings** option.

Confirm **OK**.

▲ ▼ Select option **Video**.

Confirm **OK**.

▲ ▼ Select option **HDMI IN**.

Confirm **OK**.

Audio delay Setting the audio delay (for e.g. lip-synchronised sound transmission) between **0 - 250 ms** with ◀▶ / ▶▶.

Switch Auto/ Play on/off of the Auto-Play on the TV set with ◀▶ / ▶▶.

Status Checks the HDMI connection with the TV set

END

Close menu.

Set Video Defaults

In this menu the video settings are reset to the factory set values.

➡ Call up menu as under "TV Resolution".

▲ ▼ Select option **Set Defaults**.

Confirm **OK**.

The TV resolution is reset to 576i.

Parental Controls

In this menu you can set up a password to restrict the access to the "Settings" menu as well as DVDs with **Movie Ratings** (legal protection for children and young persons).

ASSIST

Call up Main Menu.



▲ ▼ Select **Settings** option.

Confirm **OK**.

▲ ▼ Select option **Parental Controls**.

Confirm **OK**.

▲ ▼ Select option **Password protection**.

Confirm **OK**.

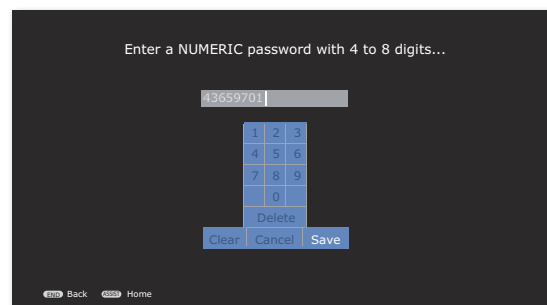

▲ ▼ ◀ ▶ Select digits / function.

0-9 Select digits between 0-9

Delete Delete a character to the left of the cursor

Clear Completely delete the input field

Cancel Close menu without saving

Save Save entry and close menu

➡ To deactivate the password protection, select **Clear** and then **Save**

Movie Ratings

This function limits play of DVDs that have an adult rating, providing the discs have a corresponding code. For full play you are asked to enter the password.

➡ Call up menu as under "Parental Controls".

▲ ▼ Select option **Movie Ratings**.

Confirm **OK**.

▲ ▼ Select required option.

Rating 0 The disc is played back completely

Rating 1 to 7 Only those scenes of the inserted disc are played which comply with the assigned security level or with a security level higher than this. Level "1" has the most play restrictions.

Start-up

System Information

You can retrieve information, such as e.g. hardware version, software version, MAC address, IP address etc. about the **Mediacenter**.

ASSIST

Call up Main Menu.



▲ ▼ Select **Settings** option.

Confirm **OK**.

▲ ▼ Select option **Utilities**.

Confirm **OK**.

▲ ▼ Select option **System information**.

Confirm **OK**.

Storage information

You can retrieve information from the harddisks installed in the **Mediacenter** **DR+**.

ASSIST

Call up Main Menu.



▲ ▼ Select **Settings** option.

Confirm **OK**.

▲ ▼ Select option **Utilities**.

Confirm **OK**.

▲ ▼ Select **Storage information**.

Confirm **OK**.

My Content

An overview of the music and movie titles detected by the **Mediacenter** on the available mediums can be obtained through the menu "My content". Additional information, such as e.g. Covers, artists, genres etc. is also shown.

ASSIST

Call up Main Menu.



▲ ▼ Select **Settings** option.

Confirm **OK**.

▲ ▼ Select option **Utilities**.

Confirm **OK**.

▲ ▼ Select option **My content**.

Confirm **OK**.

Music Display of detected music

Confirm **OK**.

Delete Music

From the menu "Delete music", you can delete the tracks available on the harddisk of the Mediacenter. A selection is also possible according to criteria, such as e.g. artists or albums **DR+**.

ASSIST

Call up Main Menu.



▲ ▼ Select **Settings** option.

Confirm **OK**.

▲ ▼ Select option **Utilities**.

Confirm **OK**.

▲ ▼ Select option **Delete music**.

Confirm **OK**.

▲ ▼ Select required option.

Genres Selection from the list of genres

Artists Selection from the list of artists

Albums Selection from the list of albums

All Tracks All Tracks on the harddisk

Confirm **OK**.

Start-up

Restart System

You can restart the **Mediacenter** from the remote control (as during switch-on from power switch).

ASSIST

Call up Main Menu.



▲ ▼ Select **Settings** option.

Confirm **OK**.

▲ ▼ Select option **Utilities**.

Confirm **OK**.

▲ ▼ Select option **Restart System**.

Confirm **OK**.

▲ ▼ Select option **Restart**.

Confirm **OK**.

Update Software

You can update the software of the **Mediacenter**, e.g. to activate new functions.

ASSIST

Call up Main Menu.



▲ ▼ Select **Settings** option.

Confirm **OK**.

▲ ▼ Select option **Utilities**.

Confirm **OK**.

▲ ▼ Select option **Update software**.

Confirm **OK**.

Auto. Update If this option is **On**, an automatic software update is performed when a newer version compared to the installed version is available.

Check for update It is checked manually whether a new software is available

Confirm **OK**.

► For update, an Internet connection is required. The process can take a long time. Under no circumstances should the device be disconnected from the power supply during the entire process.

► If there is no broadband internet connection available for the Mediacenter, please contact your dealer for a software update.

Play CD and DVD

Preconditions

When you have performed the relevant steps described in chapters “Setting up”, “Connecting” and “Startup”, switch on the **Mediacenter** as well as the devices connected to it (page 17).

Playable Discs

Only use discs that comply with the standards. This can be ascertained from the logos applied.

Disc Type		Recording Format	Contents	Disc Size
DVD Video	Regional Code 2 / ALL	Video Mode	Audio + Video (Movie)	12 cm (5")
DVD±RW/DVD±R *		Video Mode	Audio + Video (Movie)	12 cm (5")
Audio CD *		Audio CD (CD-DA)	Audio	12 cm (5")
CD-RW/CD-R *		Audio CD (CD-DA)	Audio/MP3	

* only finalised discs

Regional Code

This player can play back coded DVDs for the region “2” or “All”. The region of the device can be changed up to three times. After this, the last set region remains unchanged.

The regional code on the labels of many DVDs shows which type of DVD player can play back these discs. If you play other discs, an error message is shown on the TV screen.

Handling Discs

Do not touch the recorded side of the disc. Hold the disc by the edges to avoid touching the surface with your fingers. Do not apply any paper or sticky tape to either side of the disc.

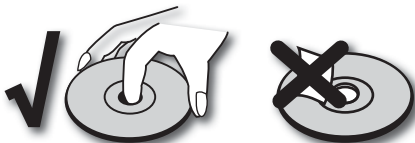

- ▶▶▶ DVD-R/RW, DVD+R/RW- and CD-R/RW discs written with a PC or a DVD or CD Recorder can not be played back if the disc is damaged or dirty or the lens of the player is covered with condensation.
- ▶▶▶ If you write a disc with a PC, it may not be possible to play back the disc, even though its format is compatible, possibly because of the settings in the application software used to burn it. (You can get further information on this from the software provider).
- ▶▶▶ Depending upon the sound recording unit, data structure or the disc itself, some of the media cannot be played back on this device.

▶▶▶ Please do not use any non-standard CD shapes (e.g. heart-shaped or octagonal) or smaller than Standard Discs (e.g. 8cm).

▶▶▶ Fingerprints and scratches on the disc can impair play. Take care of the discs.

Inserting Discs

The Mediacenter has a so-called slot-in drive. It is located on the right side. Guide the disc into the disk drive until it is drawn in automatically. The cover side of the disk faces the front side.



The device display indicates **reading** while the disc detection is on. As soon as the disc detection is complete, a message is displayed via the detected media type.

Ejecting the Disc

The inserted disc can be ejected either via remote control from the menu with the **Eject** option or from the device by pressing the symbol  on the front panel. If necessary, the disc can also be ejected mechanically, e.g. with the help of a paper clip through the emergency hole in the slot-in drive.

Play CD

Read Disc

The **Mediacenter** tries to identify the disc as soon as the CD is read. The disc will be identified by Internet based media recognition services (e.g. the Gracenote®). If the query is successful, Covers as well as possible additional information about the disc is displayed. Otherwise, the data can also be entered manually.

ASSIST

Call up Main Menu.



▲ ▼ Select option **DVD/CD player**.

Confirm **OK**.

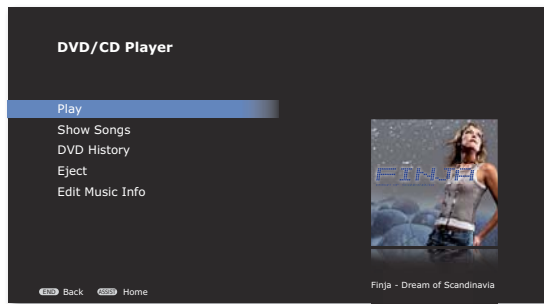

Play Start the music play of the CD.

The menu **Now Playing** appears.

Show Songs An overview of the Track is displayed

Import The tracks on an audio CD are stored as files on the haddisk of the Mediacenter (DR+)

DVD History An overview of last 100 DVD titles played back with the Mediacenter are displayed.

Eject disc The inserted CD is ejected

Edit music info The menu **Music info** appears. Title and Covers information can be edited manually

Settings Settings for import and play (DR+)

► If the disc is identified after inquiring from the databases in the Internet, the media information and if necessary, the cover is shown in the menu **DVD/CD Player**. If no appropriate information is found, the media information can also be entered manually (page 36).

CD Play

The menu **Now Playing** (page 37) is shown and the playback starts automatically.



Start the play of the selected title.



Pause Stop play. To continue play, press again.



Press briefly: Select title up/down.



Press for a long time: Keep pressed for a long time to increase the playback speed.



Stop End play.

Show Songs

You can have an overview of the tracks on the audio CD.

ASSIST

Call up Main Menu.



▲ ▼ Select option **DVD/CD player**. Confirm **OK**.

▲ ▼ Select option **Track**. Confirm **OK**.



▲ ▼ Select title.



Add album to the **Automatic playlist** (the previous automatic playlist is replaced), display menu **Now Playing** and start playing the first title

Play CD

Edit Music Info

If no corresponding information is found in the Internet, you can enter the media information manually.

ASSIST

Call up Main Menu



▲ ▼ Select option **DVD/CD Player**.

Confirm **OK**.

▲ ▼ Select option **Edit Music**.

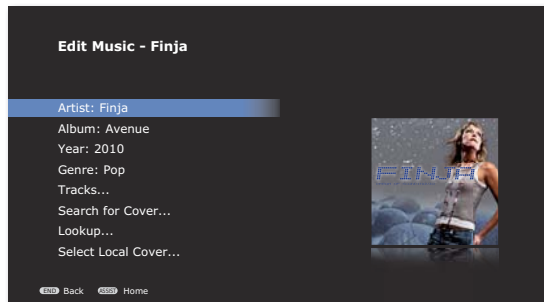

▲ ▼ Select option.

Artist Enter the name of the artist or band

Album Enter the name of the album

Year Enter the year of release

Genres Select the genre from the list

Tracks... From the list select the title, whose name you wish to edit

Search for Cover Search for the matching Covers in the Internet

Lookup... Unknown music will be identified by the Gracenote® media recognition service

Select Local Cover... Correlate the title/album with the Covers from the directory **Covers on <Mediacenter>** in the harddisk **DR+** (page 52)

Confirm **OK**.

CD Settings

You can make the settings for importing and playing audio CDs **DR+**.

ASSIST

Call up Main Menu.



▲ ▼ Select option **DVD/CD player**.

Confirm **OK**.

▲ ▼ Select **Settings** option.

Confirm **OK**.

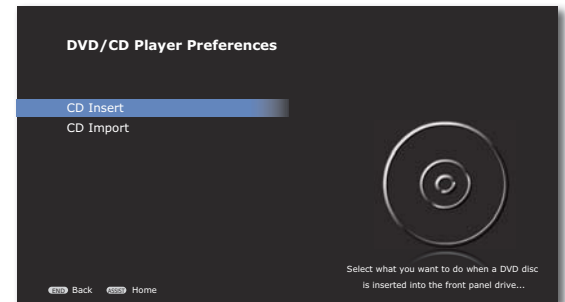

▲ ▼ Select option **CD Insert**.

Confirm **OK**.

Import and The inserted audio CD is automatically imported.

Eject The individual titles are stored as digital audio files on the harddisk. After this, the CD is automatically ejected

Display and play The Mediacenter tries to identify the inserted audio CD. If successful, Covers and media information are displayed. After this, the CD is automatically played back

Confirm **OK**.

▲ ▼ Select option **CD Import**.

Confirm **OK**.

Encoder The format of the digital audio files used to import the inserted audio CD can be set: MP3, FLAC, WAV

Bitrate The bitrate can be set for MP3 files: 128, 160, 192, 320 kBit/s. Higher bitrates offer a better sound quality, but it requires more storage space on the harddisk **DR+**

Confirm **OK**.

Play DVD

Read Disc

The Mediacenter tries to identify the disc as soon as the DVD is read. The disc will be identified by Internet based media recognition services (e.g. the Gracenote ®). If the query is successful, Covers as well as possible additional information about the disc is displayed. Otherwise, the data can also be entered manually.

ASSIST

Call up Main Menu.



▲ ▼ Select option **DVD/CD player**.

Confirm **OK**.

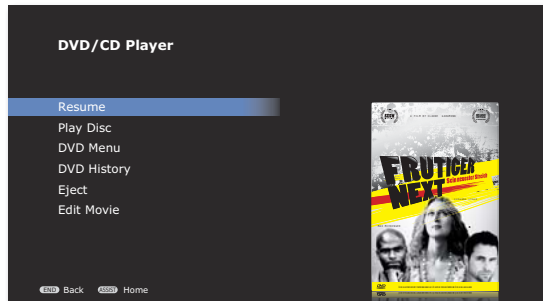

Resume The play of the inserted disc can be continued from the last location

Play Disc Start the play of the DVD from the beginning

DVD Menu The menu of the video DVD is displayed

DVD History An overview of last 100 DVD titles played back with the Mediacenter are displayed.

Eject The inserted DVD is ejected

Edit Movie The menu **Film info** appears. Title and Covers information can be edited manually

- ▣ If the disc is identified after inquiring from the databases in the Internet, the media information and if necessary, the cover is shown in the menu **DVD/CD Player**. If no appropriate information is found, the media information can also be entered manually (page 36).

DVD Play

Depending upon the DVD, the playback starts automatically or a disc menu is displayed. Follow the instructions on the screen or follow the documentation with the disc.



A menu may appear on the screen.

◀ ▶ ▲ ▼ Select title



OK Start play.



Pause Stop play. To continue play, press again.



Press briefly: Select chapter up/down.



Press for a long time: Keep pressed for a long time to increase the playback speed.



P+ / P- Select chapter up/down.



Stop End play.



Display DVD title menu



In the title menu you can - providing the DVD currently being played back supports this - set a selection of options, such as Title / Chapter selection or Subtitles.

◀ ▶ Select option.

▲ ▼ Set option.

Confirm **OK**.

- ▣ The password must be entered when the parental control level of the disc is higher than the one set for the Movie Ratings (see **Movie Ratings** on page 29).

Play DVD

DVD history

You can have an overview of the last 100 DVD titles played back by the Mediacenter.

ASSIST

Call up Main Menu.



▲ ▼ Select option **DVD/CD player**.

Confirm **OK**.

▲ ▼ Select option **DVD history**.

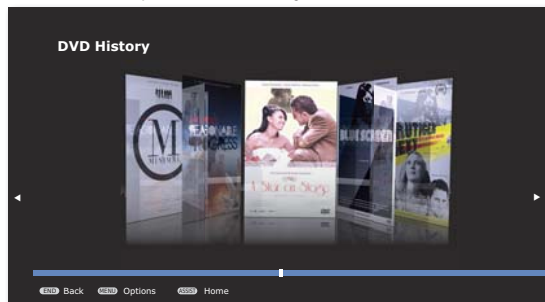

◀ ▶ Select movie.

OK Start play.

MENU

Calling up the **Options** menu.

Delete selected The selected title is removed from the DVD drive.

Delete All All titles are removed from the DVD drive.

Edit Movie

If no corresponding information is found the Internet, you can enter the media information manually.

ASSIST

Call up Main Menu.



▲ ▼ Select option **DVD/CD player**.

Confirm **OK**.

▲ ▼ Select option **Edit Movie** .

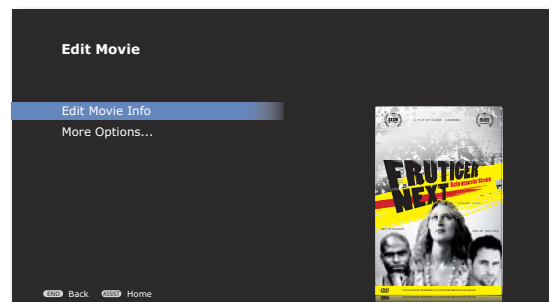

▲ ▼ Select **Edit Movie info**.

Title Enter the name of the movie

Cast Enter the names of the artists

Director Enter the name of the director

Year Enter the year of release

Genres Select the genre from the list

Classification Select the Movie Ratings (page 29)

Time Enter the runtime in minutes

Format Select the Aspect Ratio

Desc. Enter a brief description of the movie

Confirm **OK**.



Select ▲ ▼ **More Options**.

Lookup this Movie Search for the name of the DVD in the Internet

Search for Movie Search for the matching Covers in the Internet

Select local cover Correlate the movie with Covers from the harddisk
Harddisc **DR+**

Confirm **OK**.

Music Menu

The Music menu forms the central option to access various sources of music, such as network, external or internal harddisks (DR+), USB media or iPod. All available titles are shown together. You can have your music displayed sorted according to different criteria, such as e.g. according to artist, album, Covers etc.

Now Playing

In the **Now Playing** menu, the currently played Track, album and other information are displayed.



Call up **Now Playing** from any menu (except with **Screen Off/On** option).

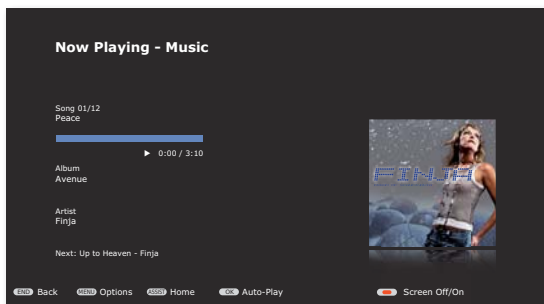

Screen off/on.



Call up **Options** menu.

Shuffle The selected titles are played in a random sequence

Repeat The selected title is repeated until the play is manually interrupted

Display autom. playlist The content of **Automatic playlist** is displayed

Clear autom. playlist The playlist is cleared (no data is deleted)

Cancel Close menu

► The title information for audio CDs cannot be called up in the **Music** menu, but rather in the **DVD/CD Player** menu under **Show songs**.

Playlists

Titles, albums, genres or any eclectic of up to 1000 titles are included in an automatic playlist, if you press the button **Play** or **OK**. With the **Play** button the selected album is completely added into the playlist and the first title starts playing. With the **OK** button, you can add a single title into the list and then sort the list.



Call up Main Menu

▲ ▼ Select option **Music**.

▲ ▼ Select option **Playlists**.

Confirm **OK**.

▲ ▼ Select playlist.

Confirm **OK**.

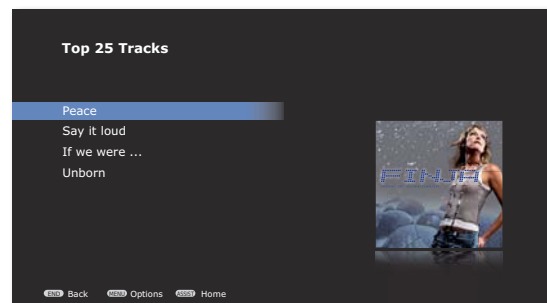

Call up **Options** menu.

Play now The selected playlist is played back

Replace autom. playlist The automatic playlist is replaced by the selected playlist

Play as next title The selected playlist is played in the end

Save playlist Save the created playlist

Edit playlist Edit the selected playlist



Rename playlist Change the name of the playlist

Delete playlist Delete the selected playlist

Add to the autom. playlist The selected title is added at the end of the automatic playlist

Add to the existing playlist The selected title is added at the end of an already existing playlist

Music Menu

- Add to a new playlist** The selected title is added at the end of a new playlist
- Remove Song** The selected song is removed from the playlist to be edited
- Cancel** Close menu
-   The selected title is moved up or down.

► Different options are available depending upon the selected playlist and medium.

Artists

You can have a list of the music available in the Mediacenter displayed sorted according to artists.



Call up Main Menu.



▲ ▼ Select option **Music**.

Confirm **OK**.

▲ ▼ Select option **Artists**.

Confirm **OK**.

An alphabetically sorted list of available artists is displayed.

P+ / P- Scroll up/down in the list.



Enter the first alphabet using the numeric keys in the remote control (as in SMS) to find the searched word.

▲ ▼ Select desired **Artists**.

Confirm **OK**.

▲ ▼ Select desired **Album**.

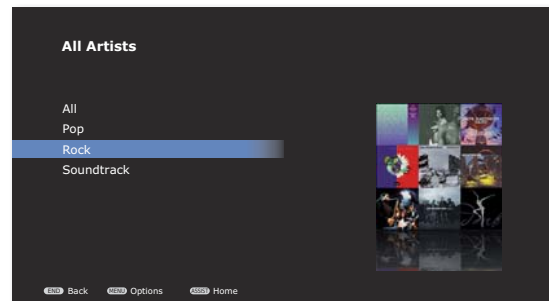

Add album to the **automatic playlist** (the previous automatic playlist is replaced), display menu **Now Playing** and start playing the first title

or

▲ ▼ Select title.



Select **MENU** option for selected title (page 37)

Music Menu

Albums

You can have a list of the music available in the Mediacenter displayed sorted according to albums.

ASSIST

Call up Main Menu.



▲ ▼ Select option **Music**.

Confirm **OK**.

▲ ▼ Select option **Albums**.

Confirm **OK**.

An alphabetically sorted list of available albums is displayed.



P+ / P- Scroll up/down in the list.

Enter the first alphabet using the numeric keys in the remote control (as in SMS) to find the searched word.



▲ ▼ Select desired **Album**.

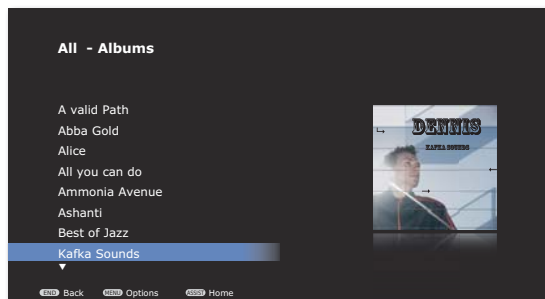

Add album to the **automatic playlist** (the previous automatic playlist is replaced), display menu **Now Playing** and start playing the first title

or

Confirm **OK**.

▲ ▼ Select title.

MENU

Select **MENU** option for selected title (page 37)

► For albums, which contain Tracks of various artists, the **Mediacenter** makes an independent entry for every artist in the list of albums.

Track

You can have a list sorted according to the tracks displayed.

ASSIST

Call up Main Menu.



▲ ▼ Select option **Music**.

Confirm **OK**.

▲ ▼ Select option **Track**.

Confirm **OK**.

An alphabetically sorted list of available titles is displayed.



P+ / P- Scroll up/down in the list.



Enter the first alphabet using the numeric keys in the remote control (as in SMS) to find the searched word.

▲ ▼ Select desired **Track**.

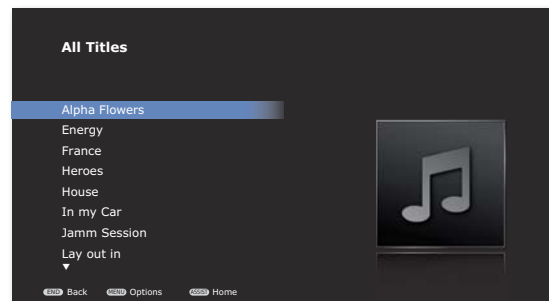

MENU

Select **MENU** option for selected title (page 37).

Music Menu

Covers

You can have a graphic display of the albums available in the Mediacenter filtered according to Genres (genres).

ASSIST



Call up Main Menu.

▲ ▼ Select option **Music**.

Confirm **OK**.

▲ ▼ Select option **Covers**.

Confirm **OK**.

▲ ▼ Select desired **Genre**.

Confirm **OK**.

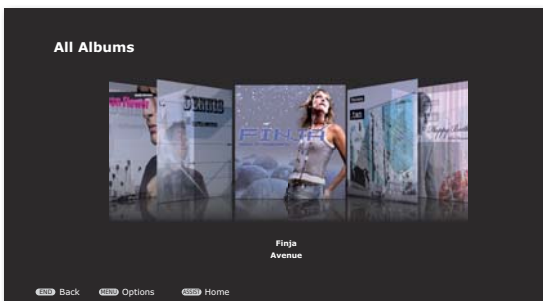

◀ ▶ Select desired **Album**.

Enter the first alphabet using the numeric keys in the remote control (as in SMS) to find the searched word.



Add album to the **automatic playlist** (the previous automatic playlist is replaced), display menu **Now Playing** and start playing the first title

or

Confirm **OK**.

▲ ▼ Select title.

MENU

Select **MENU** option for selected title (page 37).

⇒ For albums, which contain Tracks of various artists, the **Mediacenter** makes an independent entry for every artist in the list of albums.

Genres

You can have a list of the music available in the Mediacenter displayed sorted according to genres.

ASSIST



Call up Main Menu.

▲ ▼ Select option **Music**.

Confirm **OK**.

▲ ▼ Select option **Genres**.

Confirm **OK**.

An alphabetically sorted list of available Genres is displayed.

P+ / **P-** Scroll up/down in the list.



Enter the first alphabet using the numeric keys in the remote control (as in SMS) to find the searched word.

▲ ▼ Select desired **Genres**.

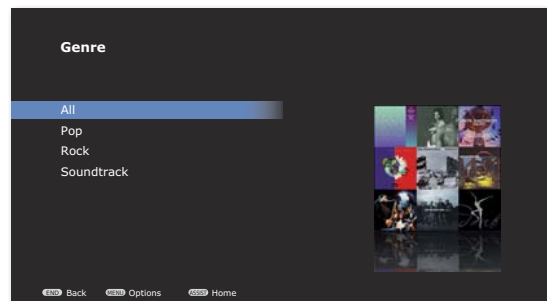

▲ ▼ Select desired **Album**.



Add album to the **automatic playlist** (the previous automatic playlist is replaced), display menu **Now Playing** and start playing the first title

⇒ For eclectic of all genres, all available titles (up to 1000) are added to the **Automatic playlist** by pressing the **Play** button.

or

▲ ▼ Select title.

MENU

Select **MENU** option for selected title (page 37).

Music Menu

Music Options

In the menu Music options, you can make the settings for the playback and manage the media information related to your music collection.

ASSIST

Call up Main Menu.



▲ ▼ Select option **Music**.

Confirm **OK**.

▲ ▼ Select **Options**.

Confirm **OK**.

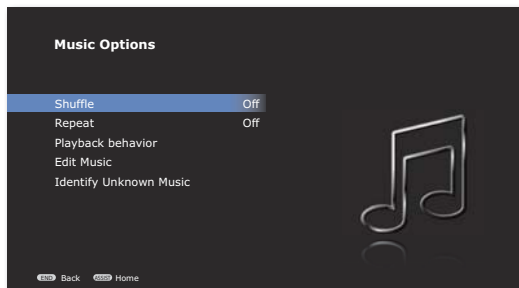

Shuffle Switch the Shuffle of the selected title **on or off**

Repeat Switch the automatic repetition of the selected title **on or off**

Playback behaviour Set the play options for the activation of the **PLAY**  and **OK** buttons.

Edit music The media information of the digital audio files can be edited

Identify Unknown Music Unknown music will be identified by the Gracenote® media recognition service

Search

You can specifically search for artists, albums and titles of the music available in the Mediacenter.

ASSIST

Call up Main Menu.



▲ ▼ Select option **Music**.

Confirm **OK**.

▲ ▼ Select **Search**.

Confirm **OK**.

▲ ▼ Select option **Artists, Album or Track**.

Confirm **OK**.

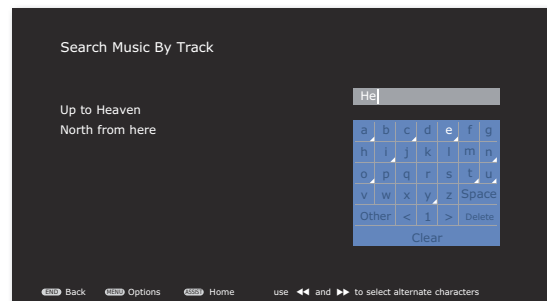

▲ ▼ ◀ ▶ Select alphabets / digits / function.

Capital Letters in uppercase

Small Letters in lowercase / special characters

Other Special characters

Space. Spaces

</> Select a digit between 0-9

Delete Delete a character to the left of the cursor

Clear Completely delete the input field



Select special characters for fields marked with a white triangle.

Confirm **OK**.

On entering alphabets/digits, the successful hits are shown immediately on the left side.

➡ Entries, in which the string appears in the middle of the expression, are also found.

◀ Press several times to make selection in the hit list.

▲ ▼ Select desired result.

Play from iPod

You can connect your iPod to the **Mediacenter** and thus enjoy your music in high quality. The **Mediacenter** has an integrated iPod Dock, which you can simply detach from the top if necessary.

Connecting iPod

Press the position marked with **PUSH** on the iPod dock until it unlocks and detaches on its own.

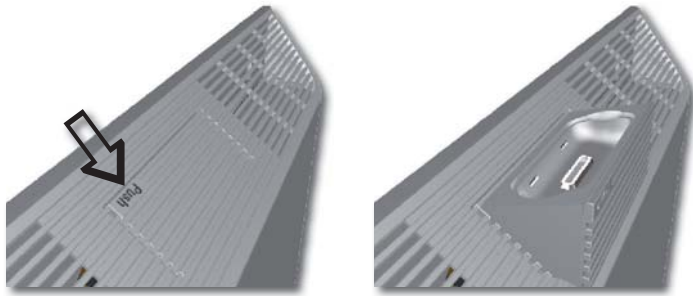

Insert the dock adapter supplied with your iPod into the charging slot of the iPod dock. Then, place your iPod in the Dock.

- ➔ See to it that only a small force is used for insertion and handling of the iPod in the Dock so that the sensitive plug connection is not damaged.

In order to ensure correct retention of an iPod Touch when using the **Mediacenter** in combination with the optional **Table Stand Individual Mediacenter**, you need to fit the self-adhesive spacer (included with in the delivery) to the iPod Dock-Adapter (included in the delivery of the iPod Touch).



Remove the protective strip from the back of the self-adhesive spacer and place it (as shown) onto the iPod Dockadapter. Fix the spacer in position using light pressure.

Menu iPod

The **iPod** menu provides you access to the music on your connected iPod. The menu is only shown when the **Mediacenter** detects the iPod. This is followed by synchronisation of the tracks available on the iPod with the **Mediacenter**. You can have your music displayed sorted according to different criteria, such as e.g. according to artist, album, Genres, Covers etc.

Now Playing (iPod)

In the **Now Playing** menu, the currently played Track, album and other information are displayed. The functions are identical to the **Now Playing** menu on page 37.

Playlists (iPod)

You can retrieve and edit the **Playlists** on the iPod.



Call up Main Menu.

▲ ▼ Select option **iPod**.

Confirm **OK**.

▲ ▼ Select option **Playlists**.

Confirm **OK**.

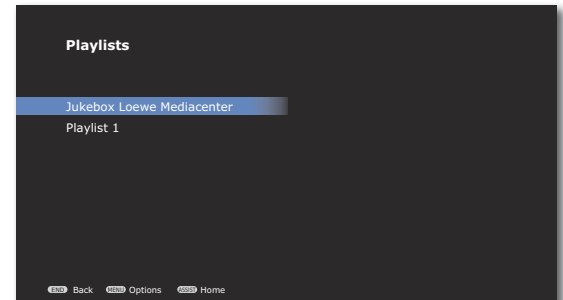

Call up **Options** menu.

- Replace the Queue** The current playlist is replaced by a new one
- Play as next title** The selected playlist is played back at the end of the current track
- Play Next** Playing the selected playlist as the next title
- Adding Music to Queue** The selected one is added into a new playlist
- Clear queue** The queue is emptied (no data is deleted)

Play from iPod

iPod Music

The selection menus for the tracks saved on your iPod correspond to the ones described under **Music** menu.

Menu **Artists**: see page 38.

Menu **Albums**: see page 38.

Menu **Tracks**: see page 39.

Menu **Covers**: see page 39.

Menu **Genres**: see page 40.

Menu **Search**: see page 41.

iPod options

In the iPod options menu you can make settings for the play and also make other settings.



Call up Main Menu.

▲ ▼ Select option **iPod**.

Confirm **OK**.

▲ ▼ Select **Options**.

Confirm **OK**.

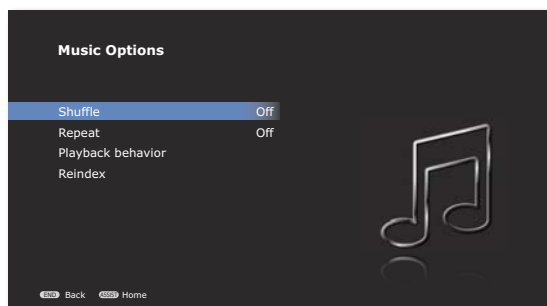

Shuffle Switch the Shuffle of the selected title **on** or **off**

Repeat Switch the automatic repetition of the selected title **on** or **off**

Playback behaviour Set the play options for the activation of the **PLAY**  and **OK** buttons.

Reindex Start reindexing manually

- ▶ Depending upon the software version, at times your iPod cannot be operated from the system. We recommend that you update the software of your iPod to the newest version.
- ▶ The compatibility with your iPod may vary depending upon the model. For supported Apple devices, see page 54.
- ▶ Malfunctions can occur depending upon the iPod device.
- ▶ Disconnect your iPod from the **Mediacenter** only if it is not being accessed.
- ▶ Your Mediacenter is certified for the operation with an iPod (for supported devices see page 54). An iPhone can however also be connected as a source of music. A message appears on the iPhone on insertion in the dock. Keep your iPhone to the aeroplane mode while it is connected with the Mediacenter. It cannot simultaneously be used as a phone.
- ▶ After a successful connection, the medium is automatically "indexed" for subsequent convenient and quick search of music. This process can take longer depending upon the size of the music collection. Wait until this process is complete.
- ▶ Your Mediacenter can manage up to five different iPods/iPhones. If a new unit is connected it replaces the oldest existing one.

Radio Operation

With your **Mediacenter** you can use several options to receive radio stations. In addition to the integrated receiver for FM radio (UKW), it is possible to receive digital radio (DVB radio), provided your **Mediacenter** is connected to an appropriately equipped Loewe TV set (page 13). In addition to this, the Internet radio can be received if a broadband Internet connection exists.

Setting FM Radio

In the menu **FM radio - Options** the radio stations can be searched automatically, the sensitivity of the receiver can be set and the name of the radio station can be changed.



Call up Main Menu.

▲ ▼ Select option **Radio**.

Confirm **OK**.

▲ ▼ Select option **FM radio**.

Confirm **OK**.

▲ ▼ Select option **Options**.

Confirm **OK**.

Automatic search

▲ ▼ Select option **Automatic search**.

Confirm **OK**.

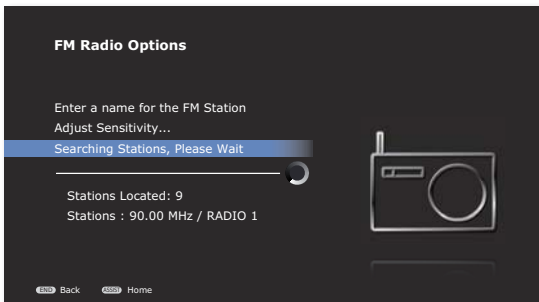

An automatic search is made through the FM radio reception range and the found radio stations are displayed and entered into a radio station list.

Adjust sensitivity

➡ Call up menu as under "Setting FM radio".

▲ ▼ Select option **Adjust Sensitivity...**

Confirm **OK**.

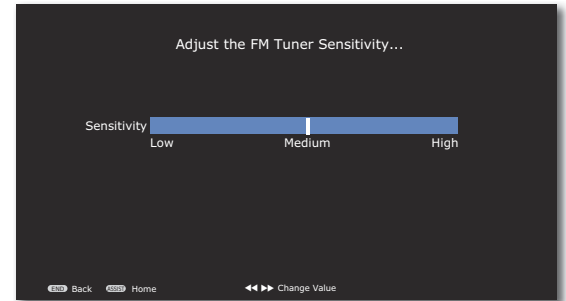

Set the FM tuner sensitivity:

Low Reception of local station or for connection with a cable system

Medium Reception of regional station

High Reception of distant station or for connection with a dipole antenna



Adjust the desired FM tuner sensitivity.



Move Back in the menu.

Renaming Station...

➡ Call up menu as under "Setting FM radio".

▲ ▼ Select option **Rename Station....**

Confirm **OK**.

▲ ▼ Select radio station to be renamed.

Confirm **OK**.

Rename Station... menu appears.

Enter a new name for the selected radio station, as described under "Mediacenter network name" on page 22.

Radio Operation

Stations by Names/Frequency

You can select the saved radio stations from a stations list sorted according to names or radio station frequencies.

ASSIST

Call up Main Menu.



▲ ▼ Select option **Radio**.

Confirm **OK**.

▲ ▼ Select option **FM radio**.

Confirm **OK**.

▲ ▼ Select option **Stations by Name** or **Stations by Frequency**.

Confirm **OK**.

▲ ▼ Select desired **Radio station**.

Confirm **OK**.

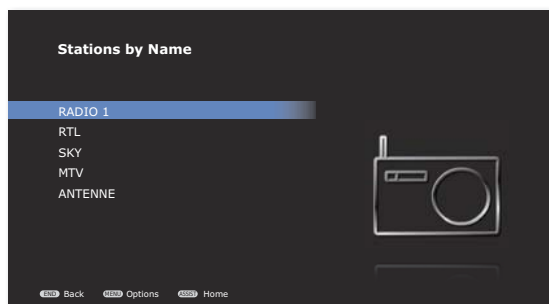

V+ / **V-** Volume up / down.



Sound on / Mute.



P+ / **P-** Scroll radio stations list backward/forward.

Now Playing - FM Radio

In the menu **Now Playing - FM radio** the radio station frequency, station name as well as other available information (via RDS), if any, is displayed for the radio station currently being played back.



Call up Now Playing from any menu (except with **Screen Off/On** option).



Screen off/on.



V+ / **V-** Volume up / down.



Sound on / Mute.



P+ / **P-** Call up next/previous radio station.



FM fine setting up/down.

MENU

Call up **Options** menu.

Save station Permanently save changes (rename station... or FM fine setting)

Delete Station The selected station is deleted from the radio station list

Cancel Close menu

Radio Operation

Internet Radio

With the **Mediacenter** you can hear Internet Radio from a large number of radio stations with different genres, if the device is connected to the Internet through broadband connection (page 19). For convenient use of this service, we recommend that you register your Mediacenter with the Loewe Support Portal. You can then create and administer your own Internet Radio.

Listening to Internet Radio



Call up Main Menu.

- ▲ ▼ Select option **Radio**. Confirm **OK**.
- ▲ ▼ Select option **Internet Radio**. Confirm **OK**.
- ▲ ▼ Select desired category. Confirm **OK**.
- ▲ ▼ Select desired **Internet radio station**.

Confirm **OK**.

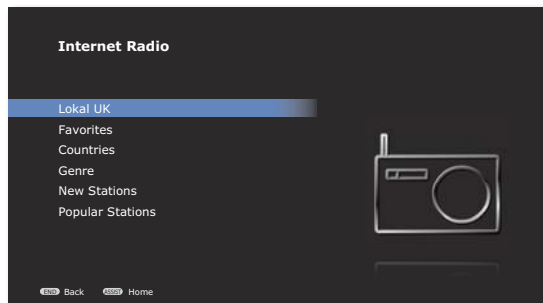

Local UK Internet radio stations in your region

Favourites Your personal favourites, which you can administer on your own via Loewe support portal in the field of Internet radio (page 47). You can also create favourites saved in the **Mediacenter** from the menu item **Add to Favorites**. The individual stations can be deleted from favourites via **Options - Remove from Favourites**

Countries Internet radio stations through a regional selection

Music settings Internet radio stations sorted according to Genres (genre)

New radio stations Recently introduced stations

Popular radio stations Popular Internet radio stations

Now Playing - Internet radio

In the menu **Now playing - Internet radio** the station name as well as other information (title, artist and station logo), if available, is displayed for the Internet radio station currently being played back.



Call up Now Playing from any menu (except with **Screen Off/On** option).

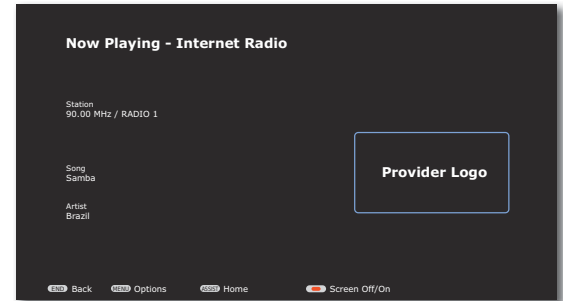

Screen off/on.



Call up **Options** menu.

Add to Favorites The selected station is added to your **Favorites**
Cancel Close menu



V+ / **V-** Volume up / down.



Sound on / Mute.

► The categories and Internet radio stations may differ depending upon the location and application.

Radio Operation

Internet Radio Favourites

From Loewe Support Portal, you can conveniently create and administer Internet radio favourite lists for your **Mediacenter** and other Internet radio devices.

To set up your favourite Internet radio stations for your **Mediacenter**, proceed as follows:

- Enter the following address in your Internet browser:
www.loewe-int.de/en/support
- If you still do not have an independent access to the Loewe Support Portal, set it up now. Click on [Register now](#). Fill out the information for your account and then click on [Create account](#). Please check whether all data is correct and then click on [Create account now](#). Shortly thereafter, you receive an email at the already specified address. Click on the link given above to confirm your registration. On successful registration, you receive an email for confirmation.
- Enter your **e-mail address** and a **Password** under **Access to your account**.
- Click on **Register Loewe product System - Individual Mediamente** and enter the data requested for your **Mediacenter**.

- When requested, enter the **MAC address** of your **Mediacenter**. It can be found under: **ASSIST** - **Settings** - **Utilities** - **System information**.
- Under the item **Your Loewe products** you will only find your **Mediacenter**. Click on the link **Mediacenter** and select in the row **Internet radio** the link **Manage Internet radio**.
- A new window opens.

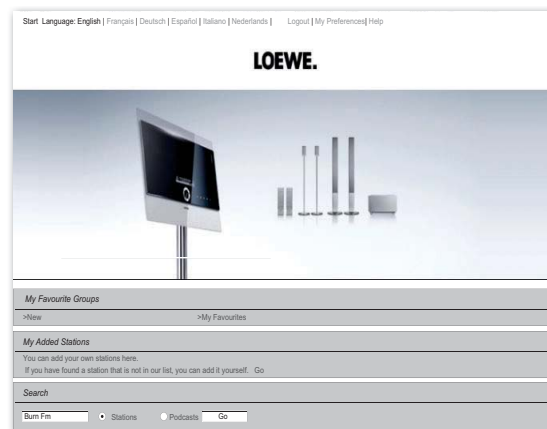

- First select the language for this Internet page from the links at the top screen margin. This language should be same as the one set by you for the menu of your **Mediacenter** (page 18).
- In the **Search** field enter the name of the desired Internet radio station and click on **Continue**.
- When the name of the searched radio station appears in the results list, click on the symbol to its right. A new window opens.

- Create a new **Favourites group** by entering a name for this group in the input field, e.g. **My Favorites** and click on **Continue**.
- A message appears that the desired radio station was added to the **Favourites group**.
- Continue with the search for other radio stations or click on **Logout** to exit the page.
- You can now listen to your favourite Internet radio stations with your **Mediacenter** as described on page 46 under **Listening to Internet radio Favourites**.

Radio Operation

DVB radio

With your **Mediacenter** you can play back digital radio (DVB radio). For this, your **Mediacenter** must be connected to an appropriately equipped Loewe TV set, which receives digital radio. The supplied cinch cable (digital audio cable: orange plug) is to be connected with the **AUDIO DIGITAL IN** socket of the **Mediacenter** and **AUDIO DIGITAL OUT** socket on your TV set. With this, the digital audio signal is transmitted to the **Mediacenter** (page 13).

Listening to DVB Radio

You can use digital radio in your **Mediacenter** as follows:

- The station list for DVB radio is set up in the TV set. The radio stations from the station list currently set in the TV set, e.g. favourites list, is played back in the **Mediacenter**. The TV set transmits the station names and numbers shown in the **Mediacenter**.
- For setting up the station list or favourites list, please refer to the operating manual of your Loewe TV set in the chapter "Administering radio stations".

ASSIST

Call up Main Menu.



▲ ▼ Select option **Radio**.

Confirm **OK**.

▲ ▼ Select option **DVB radio**.

Confirm **OK**.



P+ / P- Call up next/previous station.



Enter the number of the desired station as in the TV stations list.



Screen off/on.



V+ / V- Volume up / down.



Sound on / Mute.

Sources

With your **Mediacenter** you can play back music from external sources. These sources can be e.g. analogue or digital audio signals, USB memory or external harddisks in the home network. The menu **Other Sources** gives you an overview of possible **Wired sources of sound** as well as available **External storage media**.

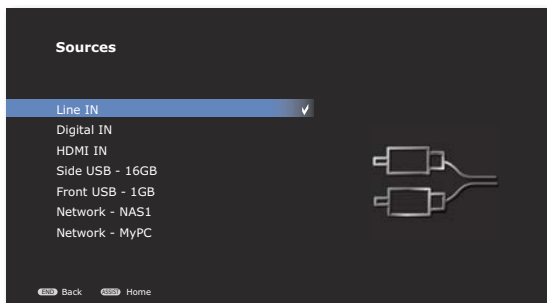

Wired Audio Sources

You can connect analogue or digital audio sources to your **Mediacenter**.

ASSIST

Call up Main Menu.



▲ ▼ Select option **Sources**.

Confirm **OK**.

▲ ▼ Select desired Source.

Line IN Analog stereo sound signal at the input **AUDIO IN L/R**

Digital IN Digital sound signal at the input **DIGITAL IN**

HDMI IN Digital sound signal at the input **HDMI IN**

Confirm **OK**.

► The currently selected audio source is marked with a tick.



V+ / **V-** Volume up / down.



Sound on / Mute.

External memories

With your **Mediacenter** you can play music stored on USB media and Network Shares (page 22). You can access these music files from the menu **Music** (page 39).

ASSIST

Call up Main Menu.



▲ ▼ Select option **Sources**.

Confirm **OK**.

▲ ▼ Select desired Source.

USB 1/2 Audio files of a **USB 1/2** connected storage medium are played back.

Network 1/2 Audio files of a storage medium connected via network are played back (see "Network Share" on page 22).

Confirm **OK**.

► The operation is same as the functions described in the chapter "play" (from page 32).

► After the connection is successfully done, the medium is automatically "indexed" so that the available titles can be easily and quickly found in the menu **Music**. This process can take longer depending upon the size of the music collection.

USB Operation

- You can connect a USB storage medium directly to the USB port.
- The standard USB 1.1 and 2.0 is supported.
- The USB device may not be disconnected during a file transfer.
- Only the file systems FAT16, FAT32 and NTFS are supported.
- Devices that require an additional software installation to be connected to a computer are not supported.
- Connection options other than the USB connections mentioned above are not supported.

Importing Music

Audio-CD Import

You can import your CD collection into the **Mediacenter** and then conveniently access it (DR+).

- First make the settings as described on page 33. If you want to import several audio CDs one after another, it is useful to set the option **CD Insert to Import and Eject**.

- In the submenu **CD Import - Encoder** select the format to be used for music coding:

MP3: Most frequently used format for loss-prone compression.

In the submenu **Bitrate** you can set the bitrate for coding the music. Higher bitrates provide a higher audio quality and at the same time require larger storage space. 192kBit/s is good compromise.

FLAC: Format for lossless compression. This format provides a good compromise between the audio quality and storage space requirement.

WAV: Format for lossless coding without compression. Due to best audio quality this format requires maximum storage space.

- Insert the CD (page 32). If you have set the option **CD Insert to Import and Eject**, the import process starts automatically. Otherwise, start the import manually.

ASSIST



Call up Main Menu.

- ▲ ▼ Select option **DVD/CD player**.

Confirm **OK**.

- ▲ ▼ Select option **Import**.

Confirm **OK**.

The **CD Import** menu is displayed.

- ▲ ▼ If required, set the option **Select/Unselect Tracks** only to import specific track.

Press **OK** to tick mark the title that you wish to import.

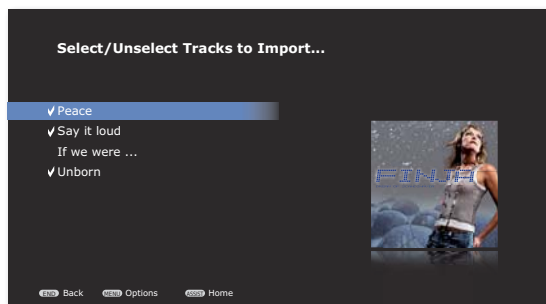

END

Close menu.

- ▲ ▼ Select option **Start Import** to start the import process. Confirm **OK**.

The import process starts. On the screen user interface you will be able to follow the progress and also read the remaining processing time.



- ▲ Cancel import process .

- ▲ Close **CD Import** menu as soon as the import process is complete.

- After the completion of the import process, the new albums/titles are available for selection in the **Music** menu.

Copying Music to Harddisk

You can copy your existing music collection (supported file formats page 54) on to the **Mediacenter** and access it conveniently from there (DR+).

- Ensure that your computer is connected to the same home network as your **Mediacenter** and start the File Manager. Under "Network environment", you will find your **Mediacenter** under the name specified by you in the **Mediacenter network name** option (page 22). The name set per default is **<Mediacenter>**.
- Open the directory **Import on <Mediacenter>**.
- With the File Manager, copy the desired music into the directory **Import on <Mediacenter>**.
- Your **Mediacenter** automatically recognises that new music files are available in the import folder and indexes them. An appropriate message is displayed at the bottom of the screen. This process may take some time depending upon the amount of data. Please wait until the process is complete.
- After the completion of the import process, the new albums/titles are available for selection in the **Music** menu.
- In order to secure the music that is saved on the hard disc of the Mediacenter, copy the content of the **Content folder on <Mediacenter>** to your PC.

Music Server

You can stream the music played which your **Mediacenter** has access to in other rooms. For this purpose, the **Mediacenter** has an integrated music server compatible with the U-PnP-AV standard. Thus, you can stream the music from CDs, harddisk, USB memory, iPod/iPhone or radio via wired or wireless home network in up to 6 rooms.

Setting up Music Server

- If possible, connect your **Mediacenter** to the wired network (Ethernet, Powerline), see page 19. Alternately, you can also use the wireless network. Principally however, the latter gives a qualitatively poorer connectivity due to external disturbances.
- Switch on the **Mediacenter**, page 17
- Make the network settings as described from page 19 onwards.
- Import the music to the harddisk (DR+) of the Mediacenter (page 50) connect external sources of sound (USB, iPod, etc.) or set up your radio reception (page 44, page 47).



Now, the **Mediacenter** is ready to transmit music to the compatible multiroom clients, such as e.g. Loewe **Multiroom Receiver** or Loewe TV sets with integrated **Network Media Player** (streaming).

Multiroom Operation

If you operate the Loewe **Mediacenter** in connection with the Loewe **Multiroom Receiver** and **Assist Media** remote control, you can comfortably stream music in your rooms from a single remote control and if necessary, easily operate your **Multiroom Receiver** via remote control from other rooms also.

On selecting **Music Server - Mediacenter**, a list of services available in the **Mediacenter** appears on the display of the **Assist Media** remote control.

- ▮ The following operation relates to the **Assist Media** remote control which is available as an accessory.
- ▮ Technically, depending upon the selected medium, there are restrictions on the number of different sources that can be streamed. The following table shows the options.

Music Source	No transmission	Single Source *	Multi-Source **
CD		X	
Internal harddisk (DR+)			X
iPod		X	
USB media			X
Network media			X
FM Radio		X	
DVB radio		X	
Internet radio	X		
Cable-linked sources		X	

* Single Source: In multiroom operation the selected source can only be streamed in one adjacent room (last one wins). This source can also be heard in the main room if it was already selected.

** Multi-Source: Different (and the same) titles from a source can be played on several **Multiroom-Receiver**s at the same time.

▮ During CD operation the titles are played on the **Multiroom receiver**, which selects this source first (first one wins). The other adjacent rooms can no more select this source and receive an error message. In the main room any title from this source can be played simultaneously without restrictions.

ROOM

Press the **ROOM** button.



▲ ▼ Select **Room**.

Confirm **OK**.

▲ ▼ Select **Music Server**.

Confirm **OK**.

▲ ▼ Select your **Mediacenter**. The name corresponds to the one set for **Network name** (page 22).

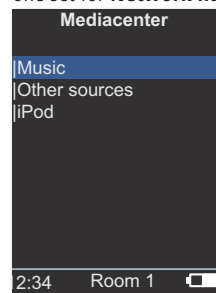

Music Server

Confirm **OK**.

- ▲ ▼ Select required media sources.

Music Selection according to criteria, such as e.g. album, artist, genre, etc.

Other Sources Mediacenter linked audio sources, such as e.g. CD drive, USB stick, wired sources, FM radio, DVB radio and Party Mode.

iPod iPod docking station of Mediacenter.

Confirm **OK**.

Party Mode

You can stream music currently being played back by the **Mediacenter** to one or more Loewe **Multiroom Receivers** in your home network.

ROOM



➡ First set the desired music play on the **Mediacenter** .

Press the **ROOM** button.

- ▲ ▼ Select **Room** .

Confirm **OK**.

- ▲ ▼ Select **Music Server**.

Confirm **OK**.

▲ ▼ Select your **Mediacenter**. The name corresponds to the one set for **Network name** (page 22).

- ▲ ▼ Select **Other Sources**.

Confirm **OK**.

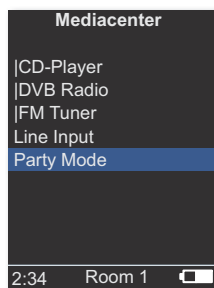

- ▲ ▼ Select **Party Mode**.

Confirm **OK**.

The music currently being played back by the **Mediacenter** is now streamed simultaneously to the **Multiroom Receiver**.

If you have multiple **Multiroom Receivers**, repeat these settings for other units also.

➡ Technically, during the playback in **Party Mode** runtime differences between the devices crop up causing echo. In this case, reduce the volume of the individual devices so that only one source can be heard in the room.



Exit **Party Mode**.

➡ For further details regarding the operation of Loewe **Multiroom Receiver**, please refer to the operating manual of the device.

Copying Covers to Harddisk

You can change the Covers for your music. For this, simply copy the desired cover file to the harddisk of your **Mediacenter** **DR+**.

- Ensure that your computer is connected to the same home network as your **Mediacenter** and start the File Manager. Under "Network environment", you will find your **Mediacenter** under the name specified by you in the **Mediacenter network name** option (page 22). The name set per default is <Mediacenter>.
- Open the directory **Covers on <Mediacenter>**.
- With the File Manager, copy the desired Covers into the directory **Covers on <Mediacenter>**.
- You can Select Local Cover in the menu **Edit Music** (page 36) and assign the desired Covers to a title/album.
- File formats: jpg and png supported.

Troubleshooting

Problem	Possible Cause	Remedy
Not working at all	Mains cable not plugged in.	Plug the mains cable into a socket 220-240 V 50 Hz.
Despite Automatic (DHCP) settings, the Mediacenter has no IP address.	No DHCP server is working on your network.	Set up a DHCP server.
	With a connection via an encrypted wireless network, you have entered the WiFi password incorrectly.	Correctly enter the WiFi password (page 21)
A displayed media file cannot be played.	The file format is not supported (page 57).	On a computer, convert the file into MP3 format, for example, by using an audio converter programme.
No sound.	Faulty connections of input or output cables.	Connect the cables properly (from page 13). If the problem persists, it is possible that the cables are faulty.
	The volume is set at minimum.	Turn up the volume.
	The sound is set to mute.	Press  or V + on the remote control to activate audio output again and then adjust the volume.
No sound and long time to start up.	The set was switched off during operation with the mains switch.	First switch the set to Stand-by mode before switching it off with the mains switch (page 17).
No picture.	The video connection with the TV set is analog and the screen resolution is set at a value higher than 576i.	Simultaneously press the green - yellow - 0 buttons on the remote control to reset the screen resolution to 576i.
The unit is not working properly.		Unplug the mains plug from the mains socket and then try plugging it in again after 30 seconds.
The remote control is not working properly.	The battery in the remote control is flat.	Replace the batteries with new ones. Set the remote control for Sound Projector operation

If there are any problems with operation in a wireless network, such as disruptions during play or devices reacting slowly during operation, you can try the following:

- Keep at least three metres distance from microwave ovens, bluetooth devices, mobile telephones and Wi-Fi compatible devices such as printers and PDAs.
- Change the active channel on the WiFi Router.

You receive further information as well as the respective latest version of this operating manual in Loewe support portal under **Mediacenter**.

Index of key words

A

Accessories 8
Albums 39
Artists 38
AUDIO LINK 7
Automatic Return to Play 23

B

Back 7

C

CD/DVD Drive 6
CD Play 33
Cleaning 9
Company and editorial details 57
Conditions 32
Connections 27
Copying Covers to Harddisk 52
Covers 39

D

Delete Music 30
Device buttons 16
Device display 6
DHCP 19
Digital Link HD 17
Disposal 58
Distances 27
Dolby Pro Logic II Mode 24
DVD button 16
DVD history 36
DVD Play 35
DVD Playback Frequency 28

E

Early Detection Monitoring 30
Editing Music Info 36
Edit Movie 36
Ejecting the Disc 32
Environment 58
Environmental protection 8
External memories 49

F

FM Radio 44
Front view 6

G

Genre 40
Genres 40
Getting Started 2
Glossary 54

H

Handling Discs 32
Harddisk 50
HDMI CEC 17
HDMI IN 7
HDMI Output 7
HDMI Settings 22
Headphones socket 6

I

Importing Music 50
Inserting Discs 32
Internet radio 46
iPod 42, 52
iPod Dock 7
iPod options 43

L

Language 18
Legal notices 58
LEVEL 27
Loudness 25

M

Main Menu 18
Mains cable 7
Mains supply 17
Mediacenter as a Standalone Solution 15
Menu Language 18
Movie Audio 24
Movie Ratings 29
Multiroom Operation 51
Multi Source 51
Music - options 41
Music Server 51
My Content 30

N

Navigation in the Menu 18
Network 19
Network name 22
Network Share 22
Night mode 25
Now Playing 37

Index of key words

- O**
 - Operating Loewe Equipment 16
 - Operating requirements 9
 - Optional Expansions 8
- P**
 - Parental Controls 29
 - Party Mode 52
 - Password Protection 29
 - Performance 10
 - Playlist 37
 - Playlists (iPod) 42
 - Privacy Policy 23
 - Product Registration 17
- R**
 - REC button 16
 - Regional Code 32
 - Remote Control 3, 16
 - Restart System 30, 31
 - Restore defaults 16, 27
- S**
 - Scope of delivery 8
 - Screen Saver 23
 - Search 41
 - Security 9
 - Service 59
 - Settings 18
 - Setting up 8
 - Setting up the Assist Remote Control 16
 - Set-up solution 11, 12
 - Show Songs 36
 - Side View 6
 - Single Source 51
 - Sound Adjustment 24
 - Sound Components 26
 - Sound functions 16
 - Sound mode 24
 - Standby operation 23
 - Standby Timer 23
 - Storage information 30
 - Streaming 51
 - Switching on/off 16, 17
 - Switch On Volume 25
 - System Information 30, 31
- T**
 - Technical specifications 55
 - Time Zone 23
 - Track 39
 - Trademark rights 58
 - Troubleshooting 53
 - TV button 16
 - TV Resolution 28, 29
 - TV Sound Input 26
 - TV Type 28
- U**
 - Update 31
 - Update Software 31
 - USB Operation 49
 - USB socket 6
- V**
 - Volume 25
- W**
 - WiFi 21
 - Wired Audio Sources 49
 - Wired network 19
 - Wireless network 21

Glossary

C

Channel (WiFi): The channel is a certain part of the WiFi frequency band. Devices that want to communicate with each other have to use the same WiFi channel. In Europe the WiFi frequency band is currently divided into 13 channels.

Client: Also referred to as network client; describes an end device such as your TV set that is connected to the network and gets data from a (media) server to make it accessible to the user.

D

DHCP: Abbreviation for Dynamic Host Configuration Protocol. DHCP allows automatic assignment of IP addresses with the aid of a DHCP server.

DHCP-server: Network service which takes care of automatic assignment of IP addresses to clients.

DRM: Digital Rights Management. Processes to control copyright protected data. To be used correctly, DRM protected contents require not only a DRM capable device but also the possession of a license issued by the provider (to be paid for).

E

Ethernet: Cable linked data net technology for local networks (LANs). Also covers standards for e.g. plug connectors and transfer speeds.

H

Host: Computer that the server services are provided from, i.e. that makes data available. Refer also to media server.

I

ID3 tags: Additional information on MP3 files. Among other things, data related to the artist, title, album and Covers can be saved here. This data is then processed by the PC using an ID3 tag editor.

IP Address: IP addresses (Internet Protocol Addresses) are used to identify devices in an Internet Protocol (IP) network. IP addresses are made up of four groups of numbers of three digits each.

L

LAN: Abbreviation for Local Area Network. Mainly used as a name for networks with cabling (Ethernet).

M

MAC address: Hardware address of a network adapter, e.g. the network card in the PC. It is permanently assigned by the manufacturer and is used to uniquely identify devices in networks.

Mbit/sec: Information about the transfer rate in networks in megabits, i.e. millions of characters per second. With WiFi the maximum speed is 11 (IEEE 802.11b) or 54 (IEEE 802.11g) Mbit/sec, in wired nets 10 Mbit/sec or 100 Mbit/sec (Fast Ethernet).

Media-server: Stands for the device which multimedia contents are stored on, but is also the name for the service provided by the device that makes this data available to the network.

MP3: Data format for compressed audio data.

N

NAS: Abbreviation for Network Attached Storage. The term describes a hard disk which is independently linked to the network (i.e. without a PC).

R

Router: Device for connecting up several networks, e.g. home network and Internet.

S

Switch: Device for connecting several computers to a network.

U

UPnP AV: Abbreviation for Universal Plug and Play - Audio/Video. Is used to control network devices from all manufacturers. Has become a wide spread standard for home networking.

USB: Universal Serial Bus. Serial bus system for connecting external devices (USB card reader, USB stick).

W

WEP: Abbreviation for Wired Equivalent Privacy. Former standard process in the WiFi encryption, now outdated.

WiFi: Abbreviation for Wireless Local Area Network. Also abbreviated as wireless network.

WMA: Abbreviation for Windows Media Audio, Microsoft own audio data format. As with MP3 files, the content is compressed here as well.

WPA: Abbreviation for Wi-Fi Protected Access. Replaced WEP as standard encryption for wireless networks.

Wired network: see LAN.

Wireless network: see WiFi.

Technical specifications

General

Individual Mediacycenter	Art.No. 68202 B00
Individual Mediacycenter DR+	Art.No. 68202 B40
Operating temperature	5 °C ... 35 °C
Humidity	30 % ... 90 % (no condensation)
Dimensions (approx.)	475 x 353 x 63.5 mm (W x H x D)
Weight of Mediacycenter / DR+	6.9 kg/7.1kg
Weight / DR+ with table base	9.7 kg/10kg

Electrical Data

Power supply	AC 220 - 240V, 50/60 Hz
Power consumption / DR+	Operation: 35 W / 40 W Standby active: 22 W / 27 W Standby Power Down: 0.5 W / 0.5 W 2.4 GHz

Frequency range

Interfaces

AUDIO IN R/L	Analogue, Stereo 1 V, 10 kOhm, RCA socket
AUDIO OUT R/L	Analogue, Stereo 1 V, 10 kOhm, RCA socket
AUDIO DIGITAL IN	SPDIF, 44.1/48/64/88.2/96 kHz, RCA socket
AUDIO DIGITAL OUT	Coaxial 44.1 kHz, RCA socket
VIDEO COMPONENT OUT	(Y) 1.0 V (p-p), 75 Ohm (Pb)/(Pr) 0.7 V (p-p), 75 ohms, RCA sockets x 3
HDMI IN	Type A, 19 Pin, LVDS digital, V1.3
HDMI OUT	Type A, 19 Pin, LVDS digital, V1.3
ANT FM	FM antenna input, 75 Ohm
Headphones	jack plug 3.5 mm
AUDIO LINK	26 pin D-SUB, Loewe System
RS-232	9-pin RJ12
LAN	Wired network RJ-45
USB	2x V 2.0, Type A

File formats supported

Audio	MP3, WMA (without DRM), FLAC, AAC, WAV, LPCM, OGG
-------	---

Home networking standard

Audio	Universal Plug and Play Audio/Video (UPnP AV)
-------	---

Wired network

Standards supported	10 Mbit/s Ethernet (10Base-T), 100 Mbit/s Fast Ethernet (100Base-T) 1000 Mbit/s Fast Ethernet (1000Base-T)
---------------------	--

Wireless network (WiFi)

Supported standards	IEEE 802.11b and 802.11g
Frequency range	2400-2483.5 MHz
Encryption	WEP, WPA, WPA2

Supported Apple devices

Audio	iPod 3G - 5G, nano 2G - 4G, classic, touch 1G - 2G, iPhone - 3GS
-------	---

Company and editorial details

Loewe AG is a public limited company under German law with its Head Office in Kronach.

Industriestrasse 11, 96317 Kronach
Telephone: + 49 (0)9261 / 99-0
Fax: + 49 (0)9261 / 99-500
E-mail: ccc@loewe.de

Trade Register: Municipal Court Coburg, No. HRB 42243
VAT ID-No.: DE 193216550
WEEE Registration number: DE 41359413

Issue 04.10. 3rd Edition
SW: V1.2.2.15

© Loewe Opta GmbH, Kronach

All rights reserved including translation.

Design and technical specifications are subject to change without notice.

Environment

Environmental Protection

Cardboard box and packaging

In line with national regulations regarding the disposal of packaging materials, we pay a fee to authorised recyclers who collect packaging from dealers. Nevertheless, we recommend that you keep the original cardboard box and the rest of the packaging materials so that the unit can, if necessary, be transported in the safest possible conditions.

The Unit



Important: The EU Directive 2002/96/EC governs the proper return, handling and recycling of used electronic appliances. Old electronic appliances must therefore be disposed of separately. Never dispose of this unit in the normal domestic waste! You can hand in your old unit free of charge at identified collection points or to your dealer if you buy a similar new unit.

Other details about return (also for non-EU countries) are available from your local authorities.

Remote control batteries



The batteries provided contain no harmful materials such as cadmium, lead or mercury.

Regulations concerning used batteries mean that batteries may no longer be thrown out with the household rubbish. You can dispose of used batteries free of charge at the collection points in commercial outlets. Your dealer will also have a collection point for used batteries.

Legal notices

This equipment has a WiFi function and complies with the essential requirements and other relevant provisions of **Directive 1999/5/EC**. It may be operated in all countries in the **EU** and also in **Iceland, Norway and Switzerland**.



The reproduction of audio and/or video programmes received or downloaded from the internet and the programme carriers on your Loewe equipment or on the storage equipment connected to it is subject to national copyright laws.

In principle, individual recordings of a live person for private use are permitted. If the programme or the recording has technical protection measures, then these must never be bypassed without the approval of the holder of the rights.

Trademark rights

Manufactured under licence from Dolby Laboratories. Dolby, ProLogic and the double-D symbol are trademarks of Dolby Laboratories.

Manufactured under license under U.S. Patent #'s: 5,451,942; 5,956,674; 5,974,380; 5,978,762; 6,487,535 & other U.S. and worldwide patents issued & pending. DTS and the Symbol are registered trademarks & DTS Digital Surround and the DTS logos are trademarks of DTS, Inc. Product includes software. © DTS, Inc. All Rights Reserved.

HDMI, the HDMI logo and High-Definition Multimedia Interface are trademarks or registered trademarks of HDMI licensing LLC.

Macrovision U.S. Patent Informationen

This product contains copyright protected technology which is protected by the process requirements of certain US patents and other intellectual copyright laws held by the Macrovision Corporation and other rights holders. The use of the copyright-protected technology must be approved by the Macrovision Corporation and applies only for limited use, unless approved otherwise by the Macrovision Corporation. Reverse Engineering or Disassembly are prohibited. U.S. Patent No. 6,836,549; 6,381,747; 7,050,698; 6,516,132; and 5,583,936.

This product contains software which has been developed by third parties and/or software covered by the GNU General Public License (GPL) and/or the GNU Lesser General Public License (LGPL).

You can hand on and/or modify it in accordance with Version 3 of the GNU General Public License or optionally any later version published by the Free Software Foundation.

The publication of this programme by Loewe is carried out WITHOUT ANY GUARANTEE OR SUPPORT, particularly without an implicit guarantee concerning MARKET MATURITY or the USABILITY FOR A SPECIFIC PURPOSE. Details can be found in the GNU General Public License.

You can obtain the software via the Loewe customer service department.

The GNU General Public License can be downloaded from:

<http://www.gnu.org/licenses/>.

Legal notices

Gracenote® End User License Agreement

USE OF THIS PRODUCT IMPLIES ACCEPTANCE OF THE TERMS BELOW.

This product contains technology and data from Gracenote of Emeryville, California ("Gracenote"). The technology from Gracenote (the "Gracenote Embedded Software") enables this product to do disc identification and obtain music-related information, including name, artist, track, and title information ("Gracenote Data"), which is included on the Gracenote Database (the "Gracenote Database").

You agree that you will use Gracenote Data, the Gracenote Database, and Embedded Software for your own personal non-commercial use only.

You agree that you will access Gracenote Data only by means of the standard end user functions and features of this product. You agree not to assign, copy, transfer or transmit the Embedded Software or any Gracenote Data to any third party. YOU AGREE NOT TO USE OR EXPLOIT GRACENOTE DATA, THE GRACENOTE DATABASE, OR GRACENOTE COMPONENT, EXCEPT AS EXPRESSLY PERMITTED HEREIN.

You agree that your non-exclusive license to use the Gracenote Data, the Gracenote Database, and Embedded Software will terminate if you violate these restrictions. If your license terminates, you agree to cease any and all use of the Gracenote Data, the Gracenote Database, and Gracenote Embedded Software. Gracenote reserves all rights in the Gracenote Data, Gracenote Database, and Gracenote Embedded Software, including all ownership rights. You agree that Gracenote may enforce its rights under this Agreement against you directly in its own name. The Embedded Software and each item of Gracenote Data are licensed to you "AS IS." Gracenote makes no representations or warranties, express or implied, regarding the accuracy of any Gracenote Data. Gracenote reserves the right to delete data or to change data categories in any Data updates and for any cause that Gracenote deems sufficient. No warranty is made that the Embedded Software is error-free or that functioning of the Embedded Software will be uninterrupted. Gracenote is not obligated to provide you with any new enhanced or additional data types or categories that Gracenote may choose to provide in the future.

GRACENOTE DISCLAIMS ALL WARRANTIES EXPRESS OR IMPLIED, INCLUDING, BUT NOT LIMITED TO, IMPLIED WARRANTIES OF MERCHANTABILITY, FITNESS FOR A PARTICULAR PURPOSE, TITLE, AND NON-INFRINGEMENT.

GRACENOTE DOES NOT WARRANT THE RESULTS THAT WILL BE OBTAINED BY YOUR USE OF THE GRACENOTE COMPONENT OR ANY GRACENOTE SERVER.

IN NO CASE WILL GRACENOTE BE LIABLE FOR ANY CONSEQUENTIAL OR INCIDENTAL DAMAGES OR FOR ANY LOST PROFITS OR LOST REVENUES.

Gracenote Corporate Description:

Music recognition technology and related data are provided by Gracenote®. Gracenote is the industry standard in music recognition technology and related content delivery. For more information visit www.gracenote.com

Gracenote Proprietary Legends:

CD and music-related data from Gracenote, Inc., copyright © 2000-2008 Gracenote. Gracenote Software, copyright © 2000-2008 Gracenote. This product and service may practice one or more of the following U.S. Patents: #5,987,525; #6,061,680; #6,154,773, #6,161,132, #6,230,192, #6,230,207, #6,240,459, #6,330,593, and other patents issued or pending. Some services supplied under license from Open Globe, Inc. for U.S. Patent: #6,304,523.

Gracenote and CDDB are registered trademarks of Gracenote. The Gracenote logo and logotype, and the "Powered by Gracenote" logo are trademarks of Gracenote.

Reseñas legales

Contrato de licencia del usuario final de Gracenote®

Esta aplicación o dispositivo contiene software de Gracenote, Inc. de Emeryville, California (denominado "Gracenote"). Este software de Gracenote (el "software Gracenote") permite que esta aplicación efectúe la identificación del disco y/o archivo y obtenga información sobre la música, incluyendo el nombre, artista, pista y título ("datos Gracenote") de los servidores en línea o bases de datos incrustadas (denominados colectivamente "servidores Gracenote") y efectúe otras funciones. Usted puede usar los datos Gracenote sólo mediante las funciones para el Usuario final de esta aplicación o dispositivo.

Usted acepta que utilizará los datos, el software y los servidores Gracenote sólo para uso personal y no comercial. Usted acepta no asignar, copiar, transferir ni transmitir el software ni datos Gracenote a terceros. USTED ACEPTA NO USAR NI EXPLOTAR DATOS, EL SOFTWARE NI LOS SERVIDORES GRACENOTE, EXCEPTO SEGÚN SE PERMITE EXPRESAMENTE EN ESTE DOCUMENTO.

Usted acepta que su licencia no exclusiva para usar los datos, el software y los servidores Gracenote terminará si infringe estas restricciones. Si su licencia termina, usted acepta cesar todo uso de los datos, el software y los servidores Gracenote. Gracenote se reserva todos los derechos de los datos, el software y los servidores Gracenote, incluyendo todos los derechos de propiedad. Bajo ninguna circunstancia Gracenote asumirá responsabilidad alguna de pagarle por la información que usted entregue. Usted acepta que Gracenote, Inc. puede hacer valer sus derechos según este Acuerdo contra usted directamente en su propio nombre.

El servicio Gracenote usa un identificador exclusivo para registrar consultas con fines estadísticos. El objetivo del identificador numérico asignado al azar es permitir que el servicio Gracenote cuente las consultas sin saber nada sobre quién es usted. Si desea más información, consulte el sitio Web, donde encontrará la Política de privacidad de Gracenote para el servicio Gracenote.

Usted recibirá licencia para el software Gracenote y cada elemento de los datos Gracenote "TAL CUAL". Gracenote no manifiesta ni emite garantías, expresas o implícitas, sobre la exactitud de los datos de Gracenote contenidos en los servidores Gracenote. Gracenote se reserva el derecho a eliminar los datos de los servidores Gracenote o a cambiar las categorías de datos por cualquier motivo que considere suficiente. No hay garantía de que el software o los servidores Gracenote estén libres de errores o que el funcionamiento del software o los servidores Gracenote será ininterrumpido. Gracenote no está obligado a proporcionar categorías o tipos de datos nuevos mejorados o adicionales que Gracenote pueda decidir proporcionar en el futuro, y tiene la libertad de poner término a sus servicios en cualquier momento. GRACENOTE INVALIDA TODAS LAS GARANTÍAS EXPRESAS O IMPLÍCITAS, INCLUYENDO, PERO SIN LIMITARSE A ELLO, LAS GARANTÍAS IMPLÍCITAS DE COMERCIABILIDAD, IDONEIDAD PARA UN FIN EN PARTICULAR, TÍTULO E INCUMPLIMIENTO. GRACENOTE NO GARANTIZA LOS RESULTADOS QUE SE OBTENDRÁN POR EL USO DEL SOFTWARE O DE CUALQUIER SERVIDOR GRACENOTE. BAJO NINGUNA CIRCUNSTANCIA GRACENOTE SERÁ RESPONSABLE POR DAÑOS CONSECUENTES O ACCIDENTALES NI POR LA PÉRDIDA DE GANANCIAS O INGRESOS.

© Gracenote, Inc. 2009

EC Declaration of Conformity

EG-Konformitätserklärung EC Conformity Declaration

Dokument-Nr./Monat . Jahr: **68202 / 10.2009**
Document No./Month . Year

Hersteller: **Loewe Opta GmbH**
Manufacturer

Handelsname: **LOEWE.**
Trade mark

Produkt: **Home Entertainment System mit CD/DVD Player und Music Server**
Product *Home Entertainment System with CD/DVD Player and Music Server*

Produktbezeichnung: **Individual Mediacenter**
Product designation

Das bezeichnete Produkt stimmt mit den Vorschriften folgender Europäischer Richtlinien überein:
The designated product conforms to the provisions of the following European directives:

2006/95/EG

Richtlinie des Rates vom 12. Dezember 2006 zur Angleichung der Rechtsvorschriften der Mitgliedsstaaten betreffend elektrischer Betriebsmittel zur Verwendung innerhalb bestimmter Spannungsgrenzen - Niederspannungsrichtlinie.
Electrical equipment designed for use within certain voltages limits - LV-Directive.

2004/108/EG

Richtlinie des Rates vom 15. Dezember 2004 zur Angleichung der Rechtsvorschriften der Mitgliedsstaaten über die elektromagnetische Verträglichkeit.
Electromagnetic compatibility

1999/5/EG

Richtlinie des Rates vom 9. März 1999 über Funkanlagen und Telekommunikationsendeinrichtungen und die gegenseitige Anerkennung ihrer Konformität

Radio equipment and Telecommunications Terminal Equipment and the Mutual Recognition of their Conformity

2005/32/EG

Richtlinie des Europäischen Parlaments und des Rates vom 6. Juli 2005 zur Schaffung eines Rahmens für die Festlegung von Anforderungen an die umweltgerechte Gestaltung energiebetriebener Produkte und zur Änderung der Richtlinie 92/42/EWG des Rates sowie der Richtlinie 96/57/EG und 2000/55/EG des Europäischen Parlaments und des Rates.

Establishing a framework for the setting of ecodesign requirements for energy-using products and amending Council Directive 92/42/EEC an Directives 96/57/EC and 2000/55/EC of the European Parliament and of the Council.

Anbringung der CE-Kennzeichnung: **09**

Affixing of the CE marking

Die Übereinstimmung des bezeichneten Produkts mit den Vorschriften der Richtlinien wird nachgewiesen durch die vollständige Einhaltung folgender Normen:

The conformity of the designated product with the provisions of Directives is proved by full compliance with the following standards:

Richtlinie / Directive 2006/95/EG

EN 60065 2002 + A1 2006, A11 2008

Richtlinie / Directive 2004/108/EG

EN 55013 2001 + A1 2003, A2 2006

EN 55020 2007

EN 55022 2006 + A1 2007

EN 55024 1998 + A1 2001, A2 2003

EN 61000-3-2 2006

EN 61000-3-3 1995 + A1 2001 + A2 2005

Richtlinie / Directive 1999/5/EG

EN 62311 2008

EN 301489-1 V1.8.1

EN 301489-17 V1.3.2

EN 300328 V1.7.1

Aussteller: Loewe Opta GmbH
Issuer

Ort, Datum: Kronach, den 28.10.2009
Place, Date

Rechtsverbindliche Unterschrift:



Service

A

Loewe Austria GmbH
Parking 12
1010 Wien, Österreich
Tel +43 - 1 22 88 633 - 0
Fax +43 - 1 22 88 633 - 90
Email: loewe@loewe.co.at

AUS

International Dynamics
Australasia Pty Ltd.
129 Palmer Street
Richmond 3121, Victoria,
Australia
Tel +61 - 3 - 94 29 08 22
Fax +61 - 3 - 94 29 08 33
Email: mail@international
dynamics.com.au

B NL L

Loewe Opta Benelux NV/SA
Uilenbaan 84
2160 Antwerpen, België
Tel +32 - 3 - 2 70 99 30
Fax +32 - 3 - 2 71 01 08
Email: ccc@loewe.be

BG

Darlington Service
Kn. Klementina Street, bl. 193
1618 Sofia, Bulgaria
Tel +359 - 2 955 63 99
Fax +359 - 2 955 63 99
Email: sac@audio-bg.com

CH

Telion AG
Rütistrasse 26
8952 Schlieren, Schweiz
Tel +41 - 44 732 15 11
Fax +41 - 44 732 15 02
Email: lgelpke@telion.ch

CY

HADJIKYRIAKOS & SONS LTD.
121 Prodomos Str., P.O Box
21587
1511 Nicosia, Cyprus
Tel +357 - 22 87 21 11
Fax +357 - 22 66 33 91
Email: savvas@hadjikyriakos.
com.cy

CZ

BASYS CS SPOL. S.R.O
Sodomkova 8/1478
10200 Praha 10 - Hostivar, Česko
Tel +420 2 34 70 67 00
Fax +420 2 34 70 67 01
Email: office@basys.cz

D

Loewe Opta GmbH,
Customer Care Center
Industriestraße 11
96317 Kronach, Deutschland
Tel +49 1801-22256393
Fax +49 9261-99500
Email: ccc@loewe.de

DK

Kjaerulff1 Development A/S
C.F. Tietgens Boulevard 19
5220 Odense SØ, Denmark
Tel +45 - 66 13 54 80
Fax +45 - 66 13 54 10
Email: loewe@loewe.dk

E

Gaplasa S.A.
Conde de Torroja, 25
28022 Madrid, España
Tel +34 - 917 48 29 60
Fax +34 - 913 29 16 75
Email: loewe@maygap.com

EST

TEDRA TRADING OY
Kuusemetsa 3
Saue 76506, Estonia
Tel +372 - 50 14 817
Fax +372 - 67 09 611
Email: raivo@futurehifi.com

F

Loewe Opta France SAS
13 rue du Dépôt,
Parc del l'Europe, BP 10010
67014 Strasbourg Cédex, France
Tel +33 - 3 - 88 79 72 50
Fax +33 - 3 - 88 79 72 59
Email: loewe.france@loewe-fr.com

FIN

Karevox Oy
Museokatu 36
00100 Helsinki, Finland
Tel +358 - 9 44 56 33
Fax +358 - 9 44 56 13
Email: kare@haloradio.fi

GB

Loewe UK Limited
Century Court, Riverside Way
Riverside Business Park, Irvine,
Ayrshire
KA11 5DJ, UK
Tel +44 - 1294 315 000
Fax +44 - 1294 315 001
Email: enquiries@loewe-uk.com

GR

EISAGOGIKI EMBORIKI ELLADOS
S.A.
321 Mesogion Av.
152 31 Chalandri-Athens, Hellas
Tel +30 - 210 672 12 00
Fax +30 - 210 674 02 04
Email: christina@bose-onkyo.gr

H

Basys Magyarorszag KFT
Tó park u.9.
2045 Törökbálint, Magyar
Tel +36 - 2341 56 37 (121)
Fax +36 - 23 41 51 82
Email: basys@mail.basys.hu

HR

Plug&Play
Bednjanska 8, 10000 Zagreb
Hrvatska (Kroatia)
Tel +385 1 4929 683
Fax +385 1 4929 682
Email: loewe@loewe.hr

I

Loewe Italiana S.r.L.
Largo del Perlar, 12
37135 Verona (VR), Italia
Tel +39 - 045 82 51 611
Fax +39 - 045 82 51 622
Email: info@loewe.it

IL

Clear electronic entertainment
(2009) Ltd
13 Noah Mozes St.
Agish Ravad Building
Tel Aviv 67442, Israel
Tel +972 - 3 - 6091100
Fax +972 - 3 - 6961795
Email: yossi@pioneer-il.com

IRL

Origo Ltd
Unit 23 Magna Drive
Magna Business Park, City West
Dublin 24, Republic of Ireland
Tel +353-1-4666700
Fax +353-1-4666708
Email: service@origo.ie

KSA

SALEM AGENCIES & SERVICES CO.
Hamad Al Haqueel Street, Raw-
dah, Jeddah
Kingdom of Saudi Arabia
Tel +966 (2) 665 4616 ext: 666
Fax +966 (2) 660 7864
Email: hkurkjian@aol.com

LT

A Cappella
Ausros Vartu 5, Pasazo skg.
01129 Vilnius, Lithuania
Tel +370 - 52 12 22 96
Fax +370 - 52 62 66 81
Email: info@loewe.lt

M

DONEO CO. LTD
34/36 Danny Cremona Street
Hamrun, HMR02, Malta
Tel +356 - 21 - 22 53 81
Fax +356 - 21 - 23 07 35
Email: info@doneo.com.mt

MA

SOMARA S.A.
377, Rue Mustapha El Maani
20000 Casablanca, Morocco
Tel +212 - 22 22 03 08
Fax +212 - 22 26 00 06
Email: somara@somara.ma

N

PCE. PREMIUM CONSUMER
ELECTRONICS as
Ostre Kullerod 5
3241 Sandefjord, Norge
Tel +47 - 33 48 33 48
Fax +47 - 33 44 60 44
Email: oddgunnar@loewe.no

NZ

International Dynamics (NZ) Pty
Ltd
PO Box 109 317, Newmarket
Auckland, New Zealand
Tel +64 9 379 0179
Fax +64 9 379 0279
Email: enquiries@international
dynamics.co.nz

P

Mayro Magnetics Portugal, Lda.
Rua Professor Henrique de Barros
Edifício Sagres, 2.º. C
2685-338 Prior Velho, Portugal
Tel +351 - 21 942 78 30
Fax +351 - 21 942 78 30
Email: geral.loewe@mayro.pt

PL

DSV TRADING SA
Plac Kaszubski 8
81-350 Gdynia, Polska
Tel +48 - 58 - 6 61 28 00
Fax +48 - 58 - 6 61 44 70
Email: market@dsv.com.pl

RO

Avitech Co. SRL
1/II Pipera Tunari St.
007190 Voluntari, Ilfov, Romania
Tel +40 - 21 200 64 64
Fax +40 - 21 200 64 65
Email: andrei.silisteanu@avitech.ro

RUS

Service Center Loewe
ul. Verkhnyaya Maslovka, d. 29
125083 Moscow, Россия
Tel +7 - 495 612 50 43
Fax +7 - 495 612 47 10
Email: service@atc.ru

S

Kjaerulff 1 AB
Ridbanegatan 4, Box 9076
200 39 Malmö, Sverige
Tel +46 - 4 06 79 74 00
Fax +46 - 4 06 79 74 01
Email: sweden@kjaerulff1.com

SK

BaSys Czech & Slovak s.r.o.
Stará Vajnorská 17/A
831 04 Bratislava, Slovakia
Tel +421 2 49 10 66 18
Fax +421 2 49 10 66 33
Email: loewe@basys.sk

TR

ENKAY ELEKTRONIK SAN. Ve Tic.
Ltd. Sti.
Alemdag Cad: Site Yolu No.: 10
81230 Ümraniye/ Istanbul, Türkiye
Tel +90 - 216 634 44 44
Fax +90 - 216 634 39 88
Email: mhatipog@enkaygroup.com

UAE

Dubai Audio Center
P.O. Box 32836, Sheik Zayed Road
Dubai, UAE
Tel +971 - 4 343 14 41
Fax +971 - 4 343 77 48
Email: dacdubai@emirates.net.ae

ZA

THE SOUNDLAB (PTY) LTD
P.O. Box 31952, Kyalami 1684
Republic of South Africa
Tel +27 - 1 14 66 47 00
Fax +27 - 1 14 66 42 85
Email: loewe@mad.co.za