

SYNC

Powered by **Microsoft**

# SAY THE WORD



LINCOLN

Amazing features easily  
controlled by the sound  
of your voice.

learn how...



## WWW.SYNCMYRIDE.COM

Create an account now at SyncMyRide.com and start getting the most out of your SYNC® experience.

While on the website, you can check to see if you are eligible to receive a complimentary trial of SYNC® Services.

### This feature includes:

- **Turn-by-turn directions**
- **Traffic reports and business searches**
- **Sports scores, stock market reports and more...**

You can also:

- Check for new SYNC® features.
- Customize your account and receive Vehicle Health Reports.
- Get tips and how-to videos to enhance your SYNC® experience.

For more tips, please refer to the Troubleshooting chapter in the SYNC® supplement.





## OTHER KEY FEATURES (IF EQUIPPED)

In addition to the phone, media and voice components, your SYNC® system also offers some advanced features such as:

- **SYNC® Services** – Uses GPS technology to provide turn-by-turn directions, traffic reports, and business searches as well as information such as sports scores and more.
- **911 Assist™**: This feature can place an emergency call to a 911 operator for you after an accident.
- **Vehicle Health Report**: Allows you to run a diagnostic and maintenance report card on your vehicle and have it sent to your email.
- **Bluetooth Audio**: Allows you to stream music from your phone.
- **SYNC® AppLink™**: Allows you to connect to and use applications on your smartphone such as Pandora and Stitcher via your SYNC® system (provided your phone is compatible with these features). If your vehicle is equipped with AppLink™, you can use voice commands to control these apps.
- **Additional Applications and Updates**: Your SYNC® system is always evolving. You can, at any time, check the web site for more applications for your vehicle. Simply visit [www.SyncMyRide.com](http://www.SyncMyRide.com) or [www.syncmaroute.ca](http://www.syncmaroute.ca).

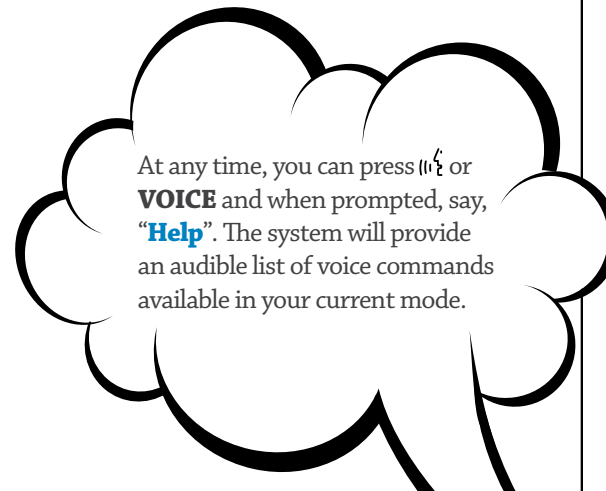
For more information on these features, please refer to the SYNC® supplement.



At any time, you can press  or **VOICE** and when prompted, say, **“Help”**. The system will provide an audible list of voice commands available in your current mode.

# HOW TO GET GOING



Simply tear along the perforated edge to take this with you for easy access later.

# FIRST THINGS FIRST!

## 1 PAIRING YOUR PHONE THE FIRST TIME

Pairing your phone with SYNC® allows it to communicate with the hands-free system, enabling you to make and receive hands-free calls and access contacts in your phone book.

- 1 Ensure that the vehicle ignition and radio are turned on and that you are in P (Park).
- 2 Press **PHONE** or . When the display indicates no phone is paired press **OK**.
- 3 When **Add Device?** appears, press **OK**.
- 4 When **Find SYNC** appears in the display, press **OK**.
- 5 Put your phone into *Bluetooth*® discovery mode. Refer to your phone's user guide if necessary.
- 6 When prompted on your phone's display, enter the six digit PIN provided by SYNC® in the radio display.
- 7 The display will indicate when the pairing is successful.
- 8 The system may prompt you with questions such as:
  - Setting your current phone as *primary* (the phone SYNC® will automatically try to connect with first upon vehicle start-up)
  - Turning on 911 Assist™
  - Downloading your phone book, etc.

### Tips:

- To pair subsequent phones, please refer to *Pairing subsequent phones* in the *Phone features* chapter of the SYNC® Supplement.
- If you are experiencing pairing problems, try performing a "clean" pairing by deleting your device from SYNC®, and deleting SYNC® from your phone and starting over.

## 2 SETTING UP YOUR USB

SYNC® allows you to access and play music from your digital media player.

- 1 Ensure that the vehicle ignition, audio system and your device are all turned on.
- 2 Plug your device into the USB port.
- 3 Press  or **VOICE** and when prompted, say, "**USB**".
- 4 You can now play music by saying any of the appropriate commands.

**Tip:** SYNC® is capable of hosting nearly any digital media player including: iPod®, Zune™, "Plays from device" players, and most USB drives. SYNC® also supports the following audio formats: MP3, WMA, WAV and ACC.

## 3 ACTIVATING YOUR FREE SERVICES

Create an account now at [SyncMyRide.com](http://SyncMyRide.com) and start getting the most out of your SYNC® experience. SYNC® Services give you the convenience of voice activated turn-by-turn directions, the latest traffic reports, business searches, sports scores, stock market reports and more. You can also set up your account to enable your vehicle to run vehicle health reports.

# commonly used voice commands

## PHONE VOICE COMMANDS

Press  or **VOICE** and when prompted, say any of the following:

<b>Call</b> <name>	<b>Call</b> <name> <b>at work</b> OR <b>Call</b> <name> <b>in office</b>
<b>Call</b> <name> <b>on mobile</b> OR <b>cell</b>	<b>Call</b> <name> <b>at home</b>
<b>Dial</b> *	

\* After saying "**Dial**", say the number you would like to call. When SYNC® confirms the number, say "**Dial**" again to initiate the call. (To end a call, press and hold  or **PHONE**.)

Press  or **VOICE** and when prompted, say, "**Phone**". You may then say any of the following:

<b>Phone book</b> <name> <b>at home</b>	<b>Phone book</b> <name>
<b>Phone book</b> <name> <b>on mobile</b> OR <b>cell</b>	<b>Phone book</b> <name> <b>at work</b> OR <b>Phone book</b> <name> <b>at office</b>
<b>Phone book</b> <name> <b>on Other</b>	<b>Go to privacy</b>
<b>Join</b>	<b>Hold</b>

### Tips:

- SYNC® only recognizes your contacts exactly as they are listed in your phone book. So, if a contact is listed as, "Wilson, Joe", you must say, "Wilson, Joe".
- Contacts listed in all caps require you to spell them (i.e. JAKE, will be J-A-K-E).

## USB VOICE COMMANDS

Press  or **VOICE** and when prompted, say, "**USB**". You may then say any of the following:

<b>Play all</b>	<b>Play genre</b> <name>
<b>Play album</b> <name>	<b>Play artist</b> <name>
<b>Play track</b> <name>	<b>Play playlist</b> <name>
<b>Play song</b> <name>	<b>Play next song</b>
<b>Play previous song</b>	<b>Similar music</b>
<b>Play next folder</b>	<b>Play previous folder</b>
<b>Repeat on</b>	<b>Repeat off</b>
<b>Shuffle on</b>	<b>Shuffle off</b>

## BLUETOOTH AUDIO VOICE COMMANDS

Press  and when prompted, say, "**Bluetooth**". You may then say any of the following:

<b>Play</b>	<b>Pause</b>
<b>Play previous track</b>	<b>Play next track</b>

## SYNC® SERVICES – TRAFFIC, DIRECTIONS & INFORMATION

Press  or **VOICE** and when prompted, say, "**Services**". The portal will guide you, but you can say any of the following:

<b>Traffic</b>	<b>Sports</b>
<b>Directions</b>	<b>Weather</b>
<b>Business Search</b>	<b>Movies</b>
<b>Favorites</b>	<b>Horoscopes</b>
<b>News</b>	<b>Stock quotes</b>
<b>Travel</b>	

### Tips:

- SYNC® services are voice-enabled, not data enabled so you don't need an extra cost data plan on your phone to use this feature.
- When connected to services, air time usage charges will be incurred. However, once the directions are downloaded, (a minute or so), the call disconnects.
- For more tips and troubleshooting information, please refer to the Troubleshooting chapter in your SYNC® supplement.

## GETTING THE BEST RESULTS WITH YOUR VOICE RECOGNITION SYSTEM

- Let the voice prompt finish before you speak and ensure the vehicle's interior environment is quiet, windows closed, no one else speaking, etc.
- Voice recognition software is sensitive, so speak your voice commands in a normal, smooth, steady and confident voice.
- Try saying "Yep" instead of "Yes" as sometimes the "s" is more difficult to pick up for the system.



## Table of Contents

<b>Welcome</b>	<b>3</b>
Privacy Information	5
<b>Understanding your voice recognition system</b>	<b>7</b>
<b>Phone features</b>	<b>10</b>
Pairing your phone for the first time	10
Pairing other phones	11
Voice commands in phone mode	12
Making and receiving calls	14
Phone menu layout	18
Accessing your phone menu features	19
Receiving a text message	21
Text messaging (sending, downloading, deleting)	21
Phone Bluetooth menu options (adding, connecting, deleting, turning on/off)	25
<b>SYNC Apps and Services</b>	<b>29</b>
Traffic, Directions and Information	29
911 Assist™	33
Vehicle Health Report	36
SYNC® AppLink™	37
<b>Media features</b>	<b>39</b>
Connecting a digital media player to SYNC®	39
Voice commands in media mode	40
Accessing your media menu features	43
Playing music (by artist, album, genre, playlist, tracks, similar)	44
Media Bluetooth menu options (adding, connecting, deleting, turning on/off)	47
Advanced menu options	48

See *End User License Agreement* at the end of this book

1

## Table of Contents

Troubleshooting	50
End user license agreement	58
Index	66

The information contained in this publication was correct at the time of going to print. In the interest of continuous development, we reserve the right to change specifications, design or equipment at any time without notice or obligation. No part of this publication may be reproduced, transmitted, stored in a retrieval system or translated into any language in any form by any means without our written permission. Errors and omissions excepted.

© Ford Motor Company 2011

2

**See *End User License Agreement* at the end of this book**

**2012 SYNC/MGM (mgm)  
Supplement, 2nd Printing  
USA (fus)**

Welcome

**WELCOME TO SYNC®**

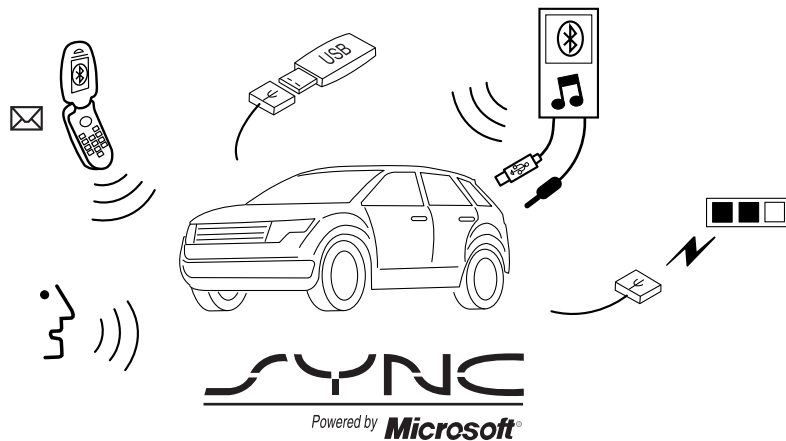

Ford ingenuity brings you SYNC® – an in-car connectivity system designed with convenience in mind.

SYNC literally ‘syncs up’ with your *Bluetooth*® enabled cellular phone and portable media player, creating a comprehensive and easy-to-use system offering features such as:

- Making and receiving calls on your *Bluetooth*® cellular phone
- Accessing and playing music from your portable music player
- 911 Assist™, Vehicle Health Reports, Traffic, Directions & Information, (if equipped)
- Using applications such as Pandora and Stitcher via SYNC® AppLink™, (if equipped)
- Accessing phonebook contacts and music via voice commands
- Streaming music from your *Bluetooth* enabled cellular phone
- Text messaging
- Advanced voice recognition fluent in English, French and Spanish
- USB device charging (if your device supports this)

Welcome to technology that is both fun and functional, welcome to SYNC®.

**See End User License Agreement at the end of this book**

3

## Welcome

### EXPORT UNIQUE (NON-UNITED STATES/CANADA) INFORMATION

For your particular global region, your vehicle may be equipped with features and options that are different from the features and options that are described in this supplement.

#### Added benefits

SYNC® even has some benefits which extend beyond your car. You can:

- Access on-line support
- Chat with other SYNC® owners
- Search for and download new applications
- Check frequently asked questions (FAQs)
- Check your phone and other devices' compatibility
- Register and set up your account to use features such as Vehicle Health Report and Traffic, Directions and Information.

Visit [www.SyncMyRide.com](http://www.SyncMyRide.com) or [www.syncmaroute.ca](http://www.syncmaroute.ca) today to access these added benefits.

#### Support

**The Troubleshooting chapter** contains common troubleshooting questions and answers on specific issues as well as some helpful hints .

**The SYNC support team** is also there if you feel like you need additional support, or if you just prefer to speak with a live person. Our team will do their best to help you with any questions you aren't able to answer on your own.

**Hours:** Monday-Saturday, 8:30 am-8pm EST

- In the United States, call: 1-888-270-1055
- In Canada, call: 1-800-565-3673

**Note:** Times are subject to change due to holidays.

#### Driving restrictions

For your safety and in order to prevent any distractions while driving, certain features are restricted when your vehicle is traveling over 3 mph (5km/h). These features will be noted as *speed dependent* when they are discussed in this supplement.

## Welcome

### Safety information



**WARNING:** Driving while distracted can result in loss of vehicle control, accident and injury. Ford strongly recommends that drivers use extreme caution when using any device that may take their focus off the road. Your primary responsibility is the safe operation of the vehicle. We recommend against the use of any handheld device while driving, encourage the use of voice-operated systems when possible and that you become aware of applicable state and local laws that may affect use of electronic devices while driving.

- Do not attempt to service or repair SYNC®. See your authorized dealer.
- Do not operate playing devices if the power cords and/or cables are broken, split or damaged. Carefully place cords and/or cables where they will not be stepped on or interfere with the operation of pedals, seats and/or compartments, or safe driving abilities.
- Do not leave playing devices in the vehicle in extreme conditions as it could cause damage to your device. Refer to your device's user guide for further information.
- Ensure that you review your device's user guide before using with SYNC®.

### Privacy information

When a cellular phone is connected to SYNC®, SYNC® creates a profile within your vehicle that is linked to that cellular phone. This profile is created in order to offer you more cellular features and to operate more efficiently. Among other things, this profile may contain data about your cellular phone book, text messages (read and unread), and call history, including history of calls when your cell phone was not connected to SYNC®. In addition, if you connect a media device, SYNC® creates and retains an index of media content supported by SYNC®. SYNC® also records a short development log of approximately 10 minutes of all recent SYNC® activity. The log profile and other SYNC® data may be used to improve SYNC® and help diagnose any problems that may occur.

The cellular profile, media device index, and development log will remain in the vehicle unless you delete it and are generally accessible only in the vehicle when the cellular phone or media player is connected. If you no longer plan to use SYNC® or the vehicle, we recommend you perform a Master Reset to erase all information stored in SYNC®.

See *End User License Agreement* at the end of this book

5

## Welcome

SYNC® data cannot be accessed without special equipment and access to the vehicle's SYNC® module. Ford Motor Company and Ford of Canada will not access SYNC® data for any purpose other than as described absent consent, a court order, or where required by law enforcement, other government authorities, or other third parties acting with lawful authority. Other parties may seek to access the information independently of Ford Motor Company and Ford of Canada. For further privacy information, see the sections on 911 Assist™ (if equipped), Vehicle Health Report (if equipped), and Traffic, Directions and Information (if equipped).

## Understanding your voice recognition system

### USING YOUR VOICE RECOGNITION SYSTEM

Your SYNC® system comes equipped with an advanced voice recognition (VR) system. This system is easy to use and helps you control many features via voice commands, thereby allowing you to keep your hands on the wheel and focus on what is in front of you.

Here we'll cover the basics of how the system works and some global voice commands. The majority of the voice commands will be covered later in the supplement with their respective modes (phone, media, etc.) and will also be indicated with the voice icon shown below.



#### Initiating a voice session

To initiate a voice session with your SYNC system:

1. Press  or VOICE.
2. Wait until you hear a tone prompt and Listening appears in the display.
3. Say any of the following global commands:
  - “Phone”: Say to make calls.
  - “USB”: Say to access the device connected to your USB port.
  - “Bluetooth Audio”: Say to stream audio from your phone.
  - “Line in” : Say to access the device connected to the auxiliary input jack.
  - “Cancel”: Say to cancel the requested action.
  - “SYNC”: Say to return to the main menu.
  - “Voice settings”: Say to adjust the level of voice interaction and feedback.
  - “Help”: Say for an audible list of voice commands available in the current mode.
  - “Vehicle Health Report” (if equipped, U.S. only): Say to run a health report.
  - “ Services” (if equipped, U.S. only): Say to access the SYNC Services portal.
  - “Mobile Apps” (if equipped, U.S. only) : Say to access the SYNC Services portal.

See *End User License Agreement* at the end of this book

7

## Understanding your voice recognition system

### System interaction and feedback

The system provides feedback through audible tones, prompts, questions and spoken confirmations depending on the situation and the chosen level of interaction (voice settings). You can customize your VR system to provide more or less instruction and feedback.

The default setting is to a higher level of interaction in order to be of more help when you are first using the system. You can change these settings at any time.

### Adjusting the interaction level

1. Press  or VOICE and when prompted, say, “Voice settings”.
2. You can say any of the following commands:

- “Interaction mode standard” / “Interaction mode advanced”

*Standard* interaction provides more detailed interaction and guidance while *advanced* has less audible interaction and more tone prompts. The system defaults to the standard setting.

- “Confirmation prompts on” / “Confirmation prompts off”

*Confirmation prompts* are short questions the system asks when it is not sure of your request or when there are multiple possible responses to your request. (For example, the system may ask, “Phone, is that correct?”) If turned off, the system will simply make a best guess as to what you requested and you may still occasionally be asked to confirm settings.



- “Phone candidate lists on” / “Phone candidate lists off”
- “Media candidate lists on” / “Media candidate lists off”

The system creates *candidate lists* when it has the same confidence level of several options based on your voice command. When turned on, the system may submit back as many as four possibilities for clarification.

For example, “Say 1 after the tone to call John Doe at home. Say 2 after the tone to call Johnny Doe on mobile. Say 3 after the tone to call Jane Doe at home.” Or, “Say 1 after the tone to play John Doe, Say 2 after the tone to play Johnny Doe.

## Understanding your voice recognition system

### *Helpful Hints*

- Ensure that the interior of the vehicle is as quiet as possible. Wind noise from open windows and road vibrations may prevent the system from correctly recognizing spoken commands.
- After pressing  or VOICE, ensure that you wait until after the tone sounds and Listening appears in the display before saying a command. Any command spoken prior to this will not register with the system.
- Speak naturally without long pauses between words.
- At any time you can interrupt the system while it is speaking by pressing  or VOICE .

## Phone features

### USING SYNC®'S PHONE FEATURES

One of the main features of SYNC is hands-free calling which works in conjunction with your *Bluetooth* enabled cellular phone. In this section, we'll cover your phone features in menu mode, applicable voice commands and also any additional options you may have.

### Phone dependent features

While SYNC® supports a variety of features, many are dependent upon the functionality of your cell phone with *Bluetooth*® wireless technology. At a minimum, most cellular phones with *Bluetooth* wireless technology support the following functions:

- Answering an incoming call
- Ending a call
- Using privacy mode
- Dial a number
- Redial
- Call waiting notification
- Caller ID

Other features, such as text messaging via *Bluetooth*, and automatic phone book download are phone dependent features. To ensure that you have a compatible cellular phone, refer to your phone's user manual and visit [www.SyncMyRide.com](http://www.SyncMyRide.com) or [www.syncmaroute.ca](http://www.syncmaroute.ca).

### PAIRING A PHONE FOR THE FIRST TIME

The first thing you must do to use a phone with the system is to wirelessly pair your phone with SYNC. Doing so allows your phone to communicate with the hands-free system, thereby enabling you to make and receive hands-free calls.

**Note:** To scroll through the menus, press ▲ / ▼ on your audio system. Depending on your system, you may also be able to press ◀ / ▶ or turn the TUNE knob.

1. Ensure that the vehicle ignition and radio are turned on and that you are in P (Park).
2. Press PHONE or . When the display indicates no phone is paired press OK.
3. When Add Bluetooth Device appears, press OK.

## Phone features

4. When Find SYNC appears in the display, press OK.
5. Put your phone into *Bluetooth* discovery mode. Refer to your phone's user guide if necessary.
6. When prompted on your phone's display, enter the six digit PIN provided by SYNC in the radio display.
7. The display will indicate when the pairing is successful.
8. Depending on your phone's capability and your market, the system may prompt you with questions such as setting the current phone as the primary phone (the phone SYNC will automatically try to connect with first upon vehicle start-up), downloading your phone book, turning on 911 Assist™ (if available), etc.

**Note:** SYNC® can support downloading up to approximately 2,000 entries per *Bluetooth* enabled cellular phone.

**Note:** If one phone has already been paired to SYNC, the process to pair another is slightly different. To pair subsequent phones, please refer to *Pairing subsequent phones* in the following section.

### Pairing subsequent phones

Once you have a phone paired with the system, the steps to pair another phone is a bit different. To pair a subsequent phone:

**Note:** To scroll through the menus, press ▲ / ▼ on your audio system. Depending on your system, you may also be able to press ◀ / ▶ or turn the TUNE knob.

1. Ensure that the vehicle ignition and radio are turned on and that you are in P (Park).
2. Press PHONE or  and scroll until System Settings is selected.
3. Press OK and scroll until Bluetooth Devices is selected and press OK.
4. Scroll until Add Bluetooth Device is selected and press OK.
5. When Find SYNC appears in the display, press OK.
6. Put your phone into *Bluetooth* discovery mode. Refer to your phone's user guide if necessary.
7. When prompted on your phone's display, enter the six digit PIN provided by SYNC in the radio display.
8. The display will indicate when the pairing is successful.

See *End User License Agreement* at the end of this book

11

## Phone features

9. The system will then prompt with questions such as if you would like to set the current phone as the primary phone (the phone SYNC will automatically try to connect with first upon vehicle start-up), download your phone book, turn on 911 Assist™ (if available), etc.



### PHONE VOICE COMMANDS

Press  or VOICE and when prompted, say, “Phone”. You may then say any of the following:

- |  |   |
|--|---|
| • Call <name> <sup>2</sup>                         | • Call <name> at home <sup>2</sup>                                      |
| • Call <name> on mobile OR cell <sup>2</sup>       | • Call <name> at work OR Call <name> in office <sup>2</sup>             |
| • Call <name> on other <sup>2</sup>                | • Dial* <sup>2</sup>  |
| • Phone book <name> at home <sup>1</sup>           | • Phone book <name> <sup>1</sup>  |
| • Phone book <name> on mobile OR cell <sup>1</sup> | • Phone book <name> at work OR Phone book <name> at office <sup>1</sup> |
| • Call history outgoing <sup>1</sup>               | • Call history incoming <sup>1</sup>                                    |
| • Phone book <name> on Other <sup>1</sup>          | • Connections <sup>1</sup>  |
| • Call history missed <sup>1</sup>                 | • Go to privacy   |
| • Menu** <sup>1</sup>                              | • Hold  |
| • Join   |   |

<sup>1</sup> Voice commands are not available until downloading phone information via *Bluetooth* is complete.

<sup>2</sup> Voice commands which are available at the first level (without having to say, “Phone”).

## Phone features

**Phone book commands:** When you ask SYNC® to access a phone book name, number, etc., the requested information will appear in the display to view. Press  or PHONE or say “Call” to call the contact.

**\* If you have said, “Dial” you can say any of the following commands:**

- |   |                                      |
|---|--------------------------------------|
| • <number> 0–9                                    | • Dial                               |
| • Delete (deletes one digit)                      | • Clear (deletes all entered digits) |
| • Plus  | • Star                               |
| • Asterisk (*)                                    | • 800 (eight hundred)                |
| • 700 (seven hundred)                             | • 900 (nine hundred)                 |
| • 411 (four-one-one),<br>911 (nine-one-one), etc. | • # / (pound, slash)                 |

**Helpful hint:** To exit dial mode, press and hold  or PHONE or press MENU to go to the PHONE MENU.

**\*\* If you have said, “Menu”, you can then say any of the following commands:**

- |  |   |
|--|---|
| • [Phone] settings [message] notification on | • [Phone] settings [message] notification off |
| • [Phone] connections                        | • Phone name                                  |
| • Signal                                     | • Battery                                     |
| • [Phone] settings [set] phone ringer        | • [Phone] settings [set] ringer 1             |
| • [Phone] settings [set] ringer 2            | • [Phone] settings [set] ringer 3             |
| • Text message inbox                         | • [Phone] settings [set] ringer off           |

**Note:** With the above commands, words in [ ] are optional and do not have to be spoken for the system to understand the command.

**At any time, you can say the following global commands:**

- |                                     |   |
|-------------------------------------|---|
| • SYNC                              | • USB   |
| • Line in                           | • Bluetooth Audio                                   |
| • Phone                             | • Voice settings                                    |
| • Cancel                            | • Vehicle Health Report<br>(if equipped, U.S. only) |
| • Services (if equipped, U.S. only) | • Mobile Apps<br>(if equipped, U.S. only)           |
| • Help                              |   |

See *End User License Agreement* at the end of this book

13



## Phone features

### MAKING AND RECEIVING CALLS WITH YOUR SYNC® SYSTEM

#### Making a call

To make a call, press  or VOICE and when prompted say:



- “Call <name>” or
- “Dial” and the desired number. When the system confirms the number, say “Dial” again to initiate the call.

**Note:** To erase the last spoken digit, say “Delete” or press . To erase all spoken digits, say “Clear” or press and hold .

To end the call, press and hold  or PHONE.



#### Answering an incoming call

During an incoming call, you will hear an audible ring. You can then:

- Answer the call by pressing  or PHONE.
- Reject the call by pressing and holding  or PHONE.
- Ignore the call by doing nothing.

#### Using the Quick Dial feature (if equipped)

If your audio system has six memory presets, you can store phone book contacts and numbers from your call history folder in 1–5 for quick access. **Note:** This feature is NOT available if your audio system has 10 memory presets (0–9).

- **To store**, simply press and hold a preset (1–5) when the desired contact information (from your phone book or call history) is active in the display.
- **To access** stored numbers, press  or PHONE and then press the memory preset containing desired contact information (1–5). Initiate the call by pressing the preset again or pressing  or PHONE.

**Note:** Quick dials are only available when the phone with which they were saved is actively paired with SYNC®.

## Phone features

### PHONE OPTIONS DURING AN ACTIVE CALL

During an active call, you have additional menu features which become available such as putting a call on hold, joining calls, etc.

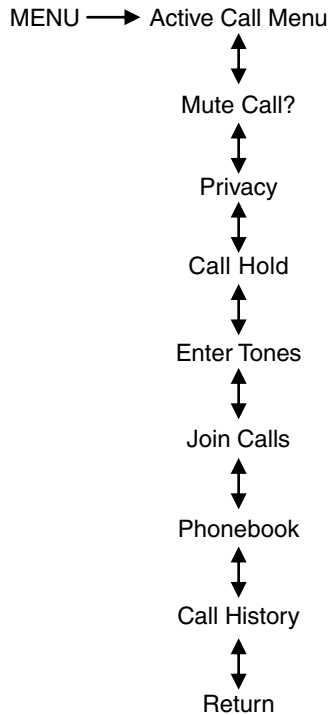

**Scrolling through the menus:** Use ▲ / ▼ to scroll through the menu options.

To access:

1. Press MENU during an active call.
2. Scroll to cycle through the following options:

**Mute Call?:** Enables you to mute the current call so that you can have a private conversation in the vehicle cabin. The display will indicate the call is muted.

See *End User License Agreement* at the end of this book

15

## Phone features

**Privacy:** Enables you to switch a call from an active hands-free environment back to your cellular phone for a more private conversation.

- Press OK to select and press OK again when Privacy on/off appears. The display will indicate In Privacy and the system will transfer your call.

**Call Hold:** Allows you to put an active call on hold to have a private conversation within the vehicle cabin or to answer another call.

1. Press OK to select and press OK again when Hold on/off appears.
2. To answer another call at this time, press  or PHONE.

**Enter Tones:** Allows you to enter 'tones' such as numbers for passwords.

1. Press OK to select and then scroll until the desired number appears in the display and press OK.
2. A tone will sound as confirmation. Repeat as necessary.

**Join Calls:** Allows you to join two separate calls and speak to both through SYNC.

1. Press  or PHONE to put your first call on hold.
2. Access the desired contact through SYNC or use voice commands to place the second call. Once actively in the second call, press MENU.
3. Scroll until Join Calls appears and press OK. Press OK again when Join Calls? appears to confirm.
4. The system will join the calls, allowing you to speak to both parties at the same time. SYNC can support a maximum of three callers on a multiparty/conference call.

## Phone features

**Phonebook:** Allows you to access your phonebook contacts.

1. Press OK to select and scroll to cycle through your phonebook contacts.
2. Press OK when the desired selection appears in the display.
3. Press  or PHONE to call the selection.

**Call History:** Allows you to access your call history log.

1. Press OK to select and scroll to cycle through your call history options (incoming, outgoing or missed).
2. Press OK when the desired selection appears in the display.
3. Press  or PHONE to call the selection.

**Return:** Press OK to exit the current menu.

## Phone features

### MANEUVERING THE PHONE MENU

Below is a graphical representation of how the phone menu lays out in your system. It will be explained in more detail in this chapter, but this may help you to better visualize the menu structure.

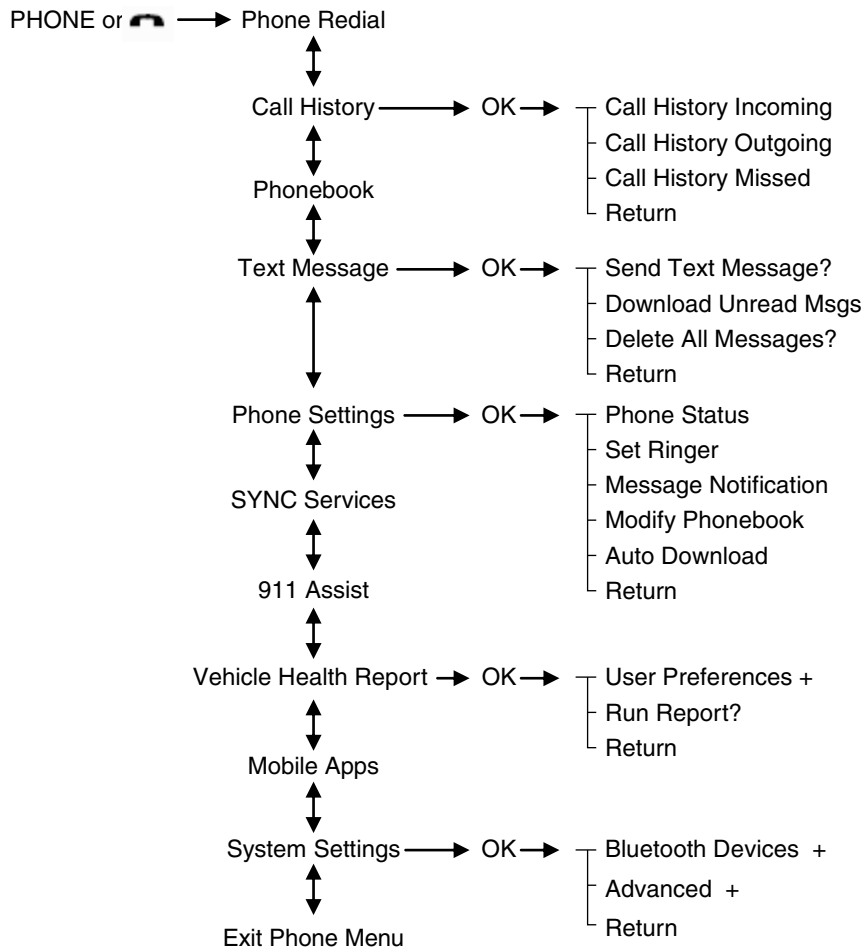

+ Denotes submenus with additional menu items

## Phone features

**Scrolling through the menus:** Press ▲ / ▼ on your audio system to scroll through the menu options. Depending on your system, you may also be able to press ◀ / ▶ or turn the TUNE knob.

### Accessing features through the phone menu

SYNC's phone menu allows you to redial a number, access your call history and phone book and send text messages as well as accessing phone and system settings. You can also access advanced features such as 911 Assist™, Vehicle Health Report and SYNC Services.

To access your phone menu:

1. Press PHONE or  to enter the Phone Menu.
2. Scroll to cycle through the following features:

**Phone Redial:** Redials the last number called (if available).

- Press OK to select and press OK again to confirm. The display will indicate *Redialing...* as it is placing the call.

**Call History: This is a phone dependent feature** which allows you to access any previously dialed, received or missed calls while your phone has been connected to SYNC.

1. Press OK to select and press OK again to enter the menu.
2. Scroll to select from Call History Incoming, Call History Outgoing or Call History Missed. Press OK to enter the chosen menu and scroll to cycle through your calls.
3. Press OK, PHONE or  to call the desired selection.

**Note:** SYNC will attempt to automatically re-download your phone book / call history each time your phone connects to SYNC (if the auto download feature is on and your *Bluetooth* enabled cellular phone supports this feature).

**Phonebook: This is a phone and speed dependent feature** which allows you to access your downloaded phonebook.

1. Press OK to confirm. **Note:** If your phonebook has less than 255 listings, they will appear alphabetically in flat file mode. If there are more, they will be organized into alphabetical categories.
2. Scroll until the desired contact appears and press OK.
3. Press OK or PHONE or  to call the contact.

**Note:** SYNC can support downloading up to approximately 2,000 entries per *Bluetooth* enabled cellular phone .

See *End User License Agreement* at the end of this book

19

## Phone features

**Text Message: This is a phone dependent feature** which enables you to send, download and delete text messages.

- Please refer to *Text Messaging* in the following section for complete information.

**Phone Settings: These are phone dependent features** which allow you to view your phone's status, set a ring tone, select your message notification, change phone book entries and also to automatically download your cellular phone among other features.

- Please refer to *Phone Settings* in the following section for complete information.

**Services** (if equipped, U.S. only): Select to access the SYNC services portal where you can request various types of information, traffic reports and directions.

- Refer to *SYNC Services* in the *SYNC Apps and Services* chapter of this supplement.

**911 Assist** (if equipped): When used properly, this can place an emergency call to a 911 operator for you after an accident.

- Refer to *911 Assist* in the *SYNC Apps and Services* chapter of this supplement.

**Vehicle Health Report** (if equipped, U.S. only): Enables you to run and receive a diagnostic report card on your vehicle.

- Refer to *Vehicle Health Report* in the *SYNC Apps and Services* chapter of this supplement.

**Mobile Apps** (if equipped, U.S. only): Enables you to interact with SYNC® capable mobile applications on your smartphone. Refer to SYNC® AppLink™ in the SYNC® Apps and Services chapter in this supplement.

**System Settings:** Allows you to access Bluetooth Devices menu listings (add, connect, set as primary, on/off, delete) as well as Advanced menu listings (prompts, languages, defaults, master reset, install application and system information).

- Refer to Bluetooth Devices menu and Advanced menu options in the following sections for more information.

**Exit Phone Menu:** Press OK when this appears in the display to exit the phone menu.

## Phone features

### Text messaging

SYNC allows you to receive, send, download and delete text messages. The system will even read incoming text messages to you so that you do not have to take your eyes off the road.

**Note:** This is a phone dependent feature.

#### **Receiving a text message**

**Note:** This is a phone dependent feature. Your phone must support downloading text messages via *Bluetooth* to receive incoming text messages.

When a new message arrives:

1. An audible tone will sound and the display will indicate you have a new message.
2. Press  or VOICE, wait for the prompt and say, "Read Message" to have SYNC read the message to you.
3. Press OK to receive and open the text message or do nothing and the message will go into your text message inbox. Press OK again and SYNC® will read your message aloud as you are not able to view the message. You can then also choose whether you'd like to reply or forward the message.
4. Press OK and scroll to choose between:
  - Reply to Text Message: Press OK to access and then scroll through the list of predefined messages to send.
  - Forward Text Message: Press OK to forward the message to anyone in your Phonebook, Call History. You can also choose to Enter Number.

**Note:** Forwarding a text message is a speed dependent feature and can only be done when the vehicle is traveling at 3 mph (5 km/h) or less.

**Note:** Only one recipient is allowed per text message.

#### **Sending, downloading and deleting your text messages**

**Text messaging is a phone dependent feature.** If your phone is compatible, SYNC allows you to receive, send, download and delete text messages.

To access:

1. Press PHONE or .
2. Scroll until Text Message appears and press OK.

**See End User License Agreement at the end of this book**

21

## Phone features

3. Scroll to select from the following options:

Send Text Message?: Enables you to send a new text message based on a predefined set of 15 messages.

1. Press OK to select. If the system detects your phone does not support this feature, *Unsupported* will appear in the display and SYNC will return you to the main menu.
2. Scroll to cycle through the following predefined text message options:

- Can't talk right now
- Call you later
- Be there in 20 minutes
- No
- Thanks
- I need more directions
- Too funny
- I'm stuck in traffic
- Call me
- Yes
- Why?
- Where R you?
- I love you
- Can't wait to see you
- Be there in 10 minutes

4. Press OK when the desired selection is in the display. The system will now need to know to whom you would like to send the message.

5. Scroll to cycle through Phonebook or Call History entries. You can also select Enter Number to audibly enter a desired number.

6. Press OK to enter the desired menu and scroll to select the specific contact.

7. Press OK when the contact appears and press OK again to confirm when the system asks if you would like to send the message.

**Note:** Each text message will be sent with the following signature: "This message was sent from my <*Ford or Lincoln*>."

**Download Unread Msgs:** Allows you to download your unread messages (only) to SYNC.

- Press OK to select. The display will indicate your messages are being downloaded. When complete, SYNC will take you to your inbox.

## Phone features

**Delete All Messages?:** Allows you to delete current text messages from SYNC (not your phone).

- Press OK to select. The display will indicate when all your text messages have been deleted and SYNC will return you to the text message menu.

**Note:** SYNC does not automatically download all of your unread text messages at every ignition cycle (as it does with call history and phonebook if automatic download is set to on).

**Return:** Press OK to exit the current menu.

### Accessing your phone settings

**These are phone dependent features.** Your phone settings allow you to access and adjust features such as your ring tone, text message notification, modifying your phone book and also setting up automatic download.

To access:

1. Press PHONE or .
2. Scroll until Phone Settings appears and press OK.
3. Scroll to select from the following options:

**Phone Status:** Shows you the provider, name, signal power, battery power and roaming status of your connected phone.

- Press OK to select and scroll to view the information. When done, press OK again to return to the phone status menu.

**Set Ringer:** Allows you to select which ring tone will sound during an incoming call (one of the system's or your phone's).

- Press OK to select and scroll to hear Ringer 1, Ringer 2, Ringer 3 and Phone Ringer. Press OK to select.

**Note:** If your phone supports in-band ringing, your phone's ringer will sound when Phone Ringer is chosen.

**Message Notification :** Gives you the option of hearing an audible tone to notify you when a text message has arrived.

- Press OK to select and scroll to select between Message Notification On or Message Notification Off . Press OK to select.

## Phone features

**Modify Phonebook:** Allows you to modify the contents of your phone book (i.e. add, delete, download).

- ↳ Press OK to select and scroll to cycle through the following options:
  - **Add Contacts:** Press OK to add more contacts from your phone book. 'Push' the desired contact(s) on your phone. Refer to your phone's user guide on how to 'push' contacts.
  - **Delete Phonebook:** Press OK to delete the current phone book and call history. When Delete Phonebook appears, press OK to confirm. SYNC will take you back to the Phone Settings menu.
  - **Download Phonebook:** Press OK to select and press OK again when Confirm Download? appears.
  - **Delete Contact:** Press OK to delete a specific contact. When *Select Contact* appears, press OK again and scroll until the name is selected. Press OK to select and again to confirm. **Note:** If automatic download is on, the contact may appear on the next automatic download.

**Auto Download:** Allows you to automatically download your cellular phone's phone book each time your phone connects to SYNC.

- ↳
  - Press OK to select. When Auto Download On? appears, press OK to have your phonebook automatically download each time. Downloading times are phone and quantity dependent. **Note:** When auto download is on, any changes, additions or deletions saved since your last download will be deleted.
  - Select *Off* to NOT download your phonebook every time your phone connects to SYNC. **Note:** Your phonebook, call history and text messages can only be accessed when your specific phone is connected to SYNC.

**Return:** Press OK to exit the current menu.

### System settings

System Settings provide access to your Bluetooth Devices and Advanced menu features.

The Bluetooth Devices menu allows you to add, connect, delete and set a phone as 'primary' as well as turn your Bluetooth feature on and off.

The Advanced menu allows you to access and set prompts, languages, defaults, perform a master reset, install an application and view system information.

## Phone features

See the following sections for more information and also the following graphic for the system settings menu layout.

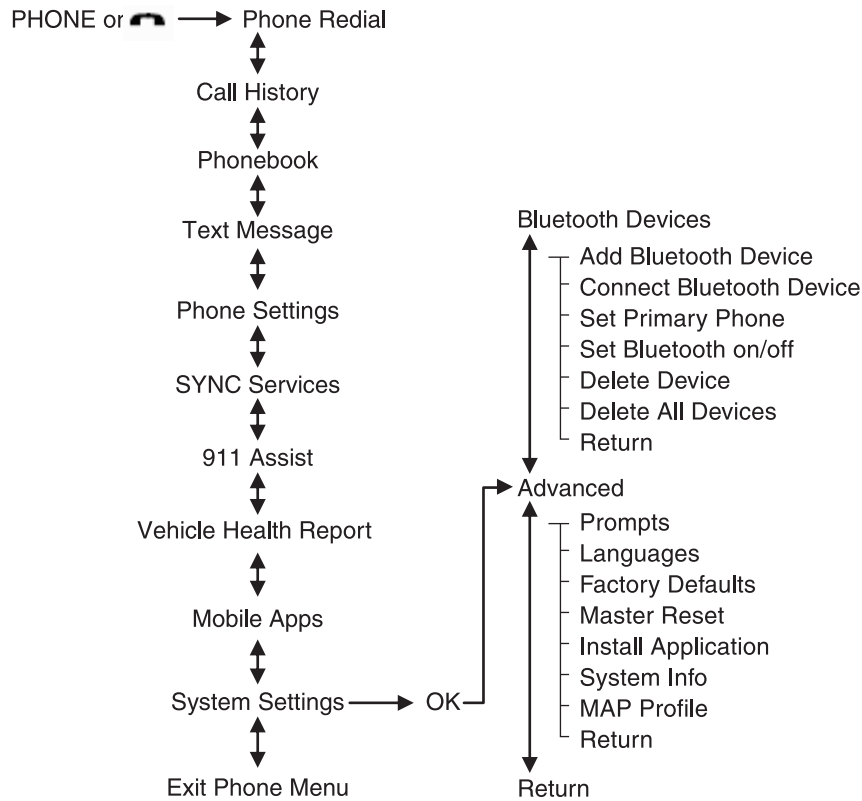

**Scrolling through the menus:** Press ▲ / ▼ on your audio system to scroll through the menu options.

### **Bluetooth Device menu options**

This menu allows you to add, connect, delete, set a phone as primary, as well as turn *Bluetooth* on and off.

To access:

1. Press PHONE or  to enter the Phone Menu.
2. Scroll until System Settings appears and press OK.

**See End User License Agreement at the end of this book**

## Phone features

3. Scroll until Bluetooth Devices appears and select OK.

4. Scroll to select from the following options:

**Add Bluetooth Device: This is a speed dependent feature** which allows you to pair additional phones to the system.

1. Press OK to select and press OK again when Find SYNC appears in the display.
2. Follow the directions in your phone's user guide to put your phone into discovery mode. A six digit PIN will appear in the display.
3. When prompted on your phone's display, enter the six digit PIN provided by SYNC.
4. When Set As Primary Phone? appears, press OK. Scroll to toggle between Yes and No and press OK.

**Note:** Setting a phone as *primary* means that SYNC will attempt to connect to this phone first at every ignition cycle.

5. Depending on the functionality of your phone, you may be asked additional questions, such as if you would like to download your phonebook or activate 911 Assist (if equipped). Scroll and use OK to select the desired responses.

**Connect Bluetooth Device:** Allows you to connect a previously paired *Bluetooth* enabled phone.

1. Press OK to select and view a list of previously paired phones.
2. Scroll until the desired device is chosen and press OK to connect the phone.

**Note:** Only one device can be connected at a time. When another phone is connected, the previous one will be disconnected.

**Set As Primary Phone?:** Select to set a previously paired phone as your primary phone. SYNC will attempt to connect with the primary phone at every ignition cycle.

- Press OK to select and scroll to select the desired phone. Press OK to confirm.

**Note:** When a phone is selected as primary, it will appear first in the list and will be marked with an \*.

## Phone features

**Set Bluetooth On/Off:** Allows you to turn the *Bluetooth* feature on /off.

- Press OK and scroll to toggle between On and Off. When the desired selection is chosen, press OK.

**Note:** Turning Off *Bluetooth* will disconnect all *Bluetooth* devices and deactivate all *Bluetooth* features.

**Delete Device:** Allows you to delete a paired phone.

- Press OK and scroll to select the device. Press OK to confirm.

**Delete All Devices:** Allows you to delete all previously paired phones.

- Press OK to select.

**Note:** Deleting a phone will also delete all information in SYNC originally saved with that phone.

**Return:** Press OK to exit the current menu.

### **Advanced menu options**

This menu allows you to access settings such as prompts, languages, defaults, perform a master reset, install an application and view system information.

To access:

1. Press PHONE or  to enter the Phone Menu.
2. Scroll until System Settings appears and press OK.
3. Scroll until Advanced appears and select OK.
4. Scroll to select from the following options:

**Prompts:** Prompts from SYNC can help guide you using questions, helpful hints or asking you for a specific action. To turn these prompts on or off:

-  1. Press OK to select and scroll to select between on or off.
2. Press OK when the desired selection appears in the display. SYNC will take you back to the Advanced menu.

## Phone features

**Languages:** Allows you to choose from three languages: English, Francais and Espanol. Once selected, all of SYNC's radio displays and prompts will be in the selected language.

1. Press OK to select and then scroll through English, Francais and Espanol.
2. Press OK when the desired selection appears in the display.

**Note:** If you change the language setting, the display will indicate that the system is updating. When complete, SYNC will take you back to the Advanced menu.

**Factory Defaults:** Allows you to return to the factory default settings. This selection will NOT erase your indexed information (phonebook, call history, text messages and paired devices).

1. Press OK to select and then press OK again when Restore Defaults? appears in the display.
2. Press OK to confirm.

**Master Reset:** Allows you to completely erase ALL information stored on SYNC (all phonebook, call history, text messages and all paired devices) and return to the factory default settings.

- Press OK to select. The display will indicate when complete and SYNC will take you back to the Advanced menu.

**Install Application?:** Allows you to install applications you have downloaded.

- Press OK and scroll to select. Press OK to confirm.

**System Info:** Allows you to access the Auto Version number as well as the FDN number.

- Press OK to select.

**MAP Profile:** Message Access Profile is a *Bluetooth* component which can further help your phone with the exchange of text messages.

**Return:** Press OK to exit the current menu.

## SYNC Apps and Services

### ACCESSING AND USING YOUR SYNC APPLICATIONS AND SERVICES (IF EQUIPPED)

In addition to the standard phone and media options which SYNC offers, your system also includes advanced features such as:

- **911 Assist™:** Can alert 911 in the event of an emergency.
- **Vehicle Health Report:** Provides a diagnostic and maintenance report card of your vehicle.
- **Traffic, Directions and Information:** Provides access to Traffic, Directions and information such as travel, horoscopes, stock prices and more.
- **SYNC® AppLink™:** Allows you to connect to and use certain applications such as Pandora and Stitcher provided your phone is compatible with these.

In order for these features to work, your cellular phone must be compatible with SYNC. To check your phone's compatibility, please visit [www.SyncMyRide.com](http://www.SyncMyRide.com) or [www.syncmaroute.ca](http://www.syncmaroute.ca).

Refer to the following sections for more information on each feature.

### SYNC® SERVICES (IF EQUIPPED, U.S. ONLY)

**Note: SYNC® Services requires activation prior to use. Visit [www.SyncMyRide.com](http://www.SyncMyRide.com) to register** and check for eligibility for complimentary services. You must also have a paired and connected *Bluetooth* enabled cellular phone in order to connect to SYNC® Services. Refer to the *Phone Features* chapter for pairing instructions.

SYNC® Services uses advanced vehicle sensors, integrated GPS technology and comprehensive map and traffic data, to give you personalized traffic reports, precise turn-by-turn directions, business search, news, sports, weather and more. For a complete list of services, or to learn more, please visit [www.SyncMyRide.com](http://www.SyncMyRide.com).

#### To connect to SYNC® Services using voice commands:

1. Press  or VOICE.
2. When prompted, say, "Services". This initiates an outgoing call to SYNC® Services using your paired and connected *Bluetooth* enabled cellular phone.
3. Once connected, follow the voice prompts to request your desired service such as "Traffic" or "Directions". You can also say, "What are my choices?" to receive a complete list of available services from which to choose.

See *End User License Agreement* at the end of this book

29

## SYNC Apps and Services

4. To return to the services main menu, say “Services” or for help, simply say, “Help”.

### **To connect to SYNC® Services using the phone menu:**

1. Press  or PHONE to enter the Phone Menu.
2. Scroll until *Services* appears in the display.
3. Press OK to confirm and enter the Services menu. The display will indicate the system is connecting.
4. Press OK. SYNC® will initiate the call to the services portal.
5. Once connected, follow the voice prompts to request your desired Service such as Traffic or Directions. You can also say, “What are my choices?” to receive a complete list of available services from which to choose.
6. To return to the services menu, say “Services” or for help, simply say, “Help”.

### **To disconnect from SYNC® Services you can:**

- Press and hold the phone button (  )
- Say “Goodbye” from the SYNC Services main menu.

### **Receiving Turn by Turn Directions:**

1. When connected to SYNC Services, say “Directions” or “Business Search”.
2. Follow the voice prompts to select your Destination. Once your destination is selected, your current vehicle location is uploaded and a route based on current traffic conditions is calculated and sent back to your vehicle . After the route download is complete, the phone call is automatically ended. You will receive driving instructions via audible prompts.
3. While on an active route, you can select or say “Route Summary” or “Route Status” for the Route summary turn list or the Route Status ETA. You can also turn voice guidance on or off, cancel the route or update the route. If you miss a turn, SYNC will automatically ask if you would like to update your route. Just say, “Yes” when prompted and a new route will be delivered to your vehicle.

**Personalizing SYNC Services:** Your SYNC Services can be personalized to provide quicker access to your most used or favorite information. You can save address points such as, work or home. You can also save favorite information like sports teams, such as ‘Detroit Lions’, or a news category. To learn more, log onto [www.SyncMyRide.com](http://www.SyncMyRide.com).

## SYNC Apps and Services

**Push to interrupt:** You can, at any time while you are connected to SYNC Services, press  to interrupt a voice prompt or an audio clip (such as a sports report) and say your voice command.

**Portable:** Your SYNC Services subscription is associated with your *Bluetooth* enabled cellular phone number, not your VIN (Vehicle Identification Number). Thus, you can use your SYNC Service with any vehicle equipped with SYNC Services. Simply pair and connect your phone to any vehicle equipped with SYNC Services and continue enjoying your personalized services. Your SYNC Services subscription enables one active phone. To change the active phone on your SYNC Services account, visit [www.SyncMyRide.com](http://www.SyncMyRide.com).

**Note:** The driver is ultimately responsible for the safe operation of the vehicle, and therefore, must evaluate whether it is safe to follow the suggested directions. Any navigation features are provided only as an aid. Make your driving decisions based on your observations of local conditions and existing traffic regulations. Do not follow the route suggestions if doing so would result in an unsafe or illegal maneuver, if you would be placed in an unsafe situation, or if you would be directed into an area that you consider unsafe. Maps used by this system may be inaccurate because of errors, changes in roads, traffic conditions or driving conditions.

**Note:** When you connect to SYNC Services, the service uses GPS technology and advanced vehicle sensors to collect the vehicle's current location, travel direction and speed to help provide you with the directions, traffic reports, or business searches you request. Further, to provide the services you request and for continuous improvement, the service may collect and record call details and voice communications. For more information, see SYNC Services, Terms and Conditions at [www.SyncMyRide.com](http://www.SyncMyRide.com). If you do not want Ford or its service providers to collect the vehicle travel information or other information identified in the Terms and Conditions, do not activate or use the service.

**Note: SYNC® Services requires activation prior to use. Visit [www.SyncMyRide.com](http://www.SyncMyRide.com) to register.** Standard phone and message rates may apply. Subscription may be required. To register and check your eligibility for free services, log onto [www.SyncMyRide.com](http://www.SyncMyRide.com).

**Note: SYNC Services will not function properly if you have enabled caller ID blocking on your mobile phone. Prior to using SYNC Services, ensure that your mobile phone is not blocking caller ID.**

See *End User License Agreement* at the end of this book

31

## SYNC Apps and Services



### Traffic, Directions & Information voice commands (if equipped, U.S. only)

When you are connect to the services portal, you may press **Ⓜ** or VOICE and when prompted say any of the following:

- Services
  - Go back
  - What are my choices?
  - Help
  - Repeat
- Available services and voice commands include:**
- Traffic
  - News
  - Favorites
  - Travel
  - Movies
  - Directions
  - Weather
  - Stocks
  - Entertainment
  - Horoscopes
- When directions are downloaded and route guidance is active, press **Ⓜ** or VOICE and after the prompt say any of the following:**
- Next turn
  - Route summary
  - Update route
  - Voice guidance off
  - Route status
  - Cancel route
  - Voice guidance on
  - Guidance display on/off \*
- \* These commands are only available on vehicles which have a center integrated display.

## SYNC Apps and Services

### 911 ASSIST™ (IF EQUIPPED)

**For 911 Assist™ to function properly, the vehicle must have battery power after the crash, the cell phone must be previously paired, connected to SYNC®, and continue to function properly with the ability to make and maintain a 911 call initiated by SYNC®, and the 911 Assist™ feature must be previously enabled (set to ON).**



**WARNING:** Do not wait for 911 Assist™ to initiate an emergency call if you are capable yourself. Dial emergency services immediately to avoid delayed response time, which could increase the risk of serious injury or death after a crash. If you do not hear 911 Assist™ within 5 seconds after the crash, the system or phone may be damaged or non-functional.

**The cell phone or 911 Assist™ hardware may become damaged in a crash, the vehicle may lose battery power, or the cell phone may be thrown from the vehicle, which could prevent operation. Additionally, every cell phone operates differently. While SYNC®, 911 Assist™ works with most cell phones, some may have trouble using this feature. Finally, not all crashes deploy an airbag or, in certain vehicles, activate the fuel pump shut-off which are the criteria to initiate 911 Assist™.**

Airbags generally deploy in certain frontal, near frontal, side and rollover crashes, and the deployment of any airbag is intended to act as a 911 Assist™ trigger if those events occur. For more information about airbag deployment, see the *Seating and Safety Restraints* chapter of your Owner Guide. The fuel pump shut-off, in certain vehicles, is intended to act as a trigger for 911 Assist™ in rear-end crashes, in which airbags generally do not deploy. To determine if your vehicle has this trigger, check the *Roadside Emergency* chapter in your Owner's Guide. If your Owner Guide describes a "Fuel Pump Shut-off", it will trigger 911 Assist™. If your Owner Guide describes a "Fuel Pump Shut-off *Switch*", it will not trigger 911 Assist™.



**WARNING:** Always place cell phone in a secure location to prevent it from becoming a projectile or becoming damaged in the event of a collision. Failure to do so may cause serious injury or damage the phone which could prevent 911 Assist from functioning properly.

## SYNC Apps and Services

**911 ASSIST™ PRIVACY NOTICE: Once 911 Assist™ is enabled (set to ON), 911 Assist™ may, through any paired and connected cell phone, disclose to emergency services that the vehicle has been in a crash involving the deployment of an airbag or, in certain vehicles, the activation of the fuel pump shut-off. Certain versions or updates to 911 Assist™ may also be capable of electronically or verbally disclosing to 911 operators the vehicle location, and/or other details about the vehicle or crash to assist 911 operators to provide the most appropriate emergency services. If you do not want to disclose this information, do not enable (set to ON) the feature.**

**Note:** If 911 Assist™ is enabled/disabled by any user, the current setting will apply for all paired phones. If the 911 Assist™ setting is disabled (set to OFF), a voice message and/or display item will inform the vehicle occupants when a previously paired phone connects to SYNC® at vehicle start up.

In the event of a crash involving the deployment of an airbag or the activation of the fuel pump shut-off, in certain vehicles, SYNC® is designed to assist occupants in attempting to contact emergency services by dialing 911 through the occupant's paired and connected *Bluetooth* enabled cellular phone. In the event that a connected cellular phone is damaged or loses connection to SYNC®, SYNC® will search for and connect to any available, previously paired cell phone and attempt to place the call to 911. Before initiating the call, SYNC® provides a short window of time (approximately 10 seconds) that allows the driver or passenger to decide whether to cancel the call by pressing and holding  or PHONE on the steering wheel controls or on the audio system. Before initiating the 911 call for the occupants, SYNC® will say the following or a similar message:

“SYNC® will attempt to call 911. If you wish to cancel the call, press and hold the phone button.”

If the call is not cancelled and a successful call is made, a pre-recorded message will be played for the 911 operator and then the occupant(s) in the vehicle will be able to communicate with the 911 operator.

**Note:** Failure to cancel the call as described above will result in SYNC® dialing 911.

**Note:** When you are connected to the 911 operator, be prepared to provide your name, phone number and location immediately, because not all 911 systems are capable of receiving this information electronically.

## SYNC Apps and Services

The following steps are required for the 911 Assist™ feature to perform properly:

- SYNC® is on and functioning properly at the time of the incident and throughout feature activation and use.
- SYNC® 911 Assist™ feature is set to ON prior to the incident.
- A *Bluetooth* enabled and compatible cellular phone is paired and connected to SYNC®.
- A connected *Bluetooth* enabled cellular phone that has the ability to make and maintain an outgoing call at the time of the incident.
- A connected *Bluetooth* enabled cellular phone that has adequate network coverage, battery power and signal strength.
- The vehicle is located in the U.S. or Canada or in a territory in which 911 is the emergency number.



**WARNING:** Unless 911 Assist™ is previously configured to ON prior to a crash, 911 Assist™ will not dial for help during an emergency, which could delay response time, increasing the risk of serious injury or death after a crash.

The 911 Assist™ feature is initially set to OFF. To access the setting:

1. Press  or PHONE to enter the Phone Menu.
2. Scroll repeatedly until 911 Assist appears in the radio display.
3. Press OK to confirm and enter the 911 Assist menu.
4. Scroll to select between On and Off selections.
5. Press OK when the desired option appears in the radio display. Set On or Set Off will appear in the display as confirmation.

**Note:** Off selections include: Off with reminder and Off without reminder. Off with reminder provides a display and voice reminder at phone connection at vehicle start. Off without reminder provides a display reminder only without a voice reminder.

For more information, please visit [www.SyncMyRide.com](http://www.SyncMyRide.com) or [www.syncmaroute.ca](http://www.syncmaroute.ca).

**Note: Before enabling (setting to ON), review the 911 Assist™ Privacy Notice.**

See *End User License Agreement* at the end of this book

35

## SYNC Apps and Services

### VEHICLE HEALTH REPORT (IF EQUIPPED, U.S. ONLY)



**WARNING:** Always follow scheduled maintenance instructions, regularly inspect your vehicle, and seek repair for any damage or problem you suspect. Vehicle Health Reports supplements, but cannot replace normal maintenance and vehicle inspection. Vehicle Health Report only monitors certain systems that are electronically monitored by the vehicle and will not monitor or report the status of any other system, (i.e., brake lining wear). Failure to perform scheduled maintenance and regularly inspect your vehicle may result in vehicle damage and serious injury.

**Note: Your Vehicle Health Report feature requires activation prior to use. Visit [www.SyncMyRide.com](http://www.SyncMyRide.com) to register.** There is no fee or subscription associated with Vehicle Health Report, but you **must** register to use this feature.

SYNC® allows you to check your vehicle's overall 'health' in the form of diagnostic report card. The vehicle health report contains valuable information such as:

- Vehicle Diagnostic Information
- Scheduled maintenance
- Open Recalls and Field Service Actions
- Unserved items from vehicle inspections by your authorized dealer

**VEHICLE HEALTH REPORT PRIVACY NOTICE: When you run a Vehicle Health Report, Ford Motor Company may collect your cell phone number (to process your report request) and diagnostic information about your vehicle. Certain versions or updates to Vehicle Health Report may also collect additional vehicle information. Ford may use the vehicle information it collects for any purpose. If you do not want to disclose your cell phone number or vehicle information, do not run the feature or set up your Vehicle Health Report profile at [www.SyncMyRide.com](http://www.SyncMyRide.com). Refer to [www.SyncMyRide.com](http://www.SyncMyRide.com) — Vehicle Health Report Terms and Conditions, and Privacy Statement — for more information.**

You can initiate a Vehicle Health Report in the vehicle and view the complete report with all information listed above on SyncMyRide.com. You can also choose for SYNC® to automatically remind you to run reports at specific mileage intervals. After you've registered for the Vehicle Health Report service and established your preferences at [www.SyncMyRide.com](http://www.SyncMyRide.com), you can then request a Vehicle Health Report (in your vehicle) and return to your account at [www.SyncMyRide.com](http://www.SyncMyRide.com) to view your report. Cell phone airtime usage may apply when reporting.

## SYNC Apps and Services

To access and run a report (after the vehicle has been running a minimum of 60 seconds):

1. Press PHONE to enter Phone Menu.
2. Scroll until *Vehicle Health* is selected and press OK.
3. Scroll to select from the following options:



- **Run Report:** Press OK for SYNC to run a health report of your vehicle's diagnostic systems and send the results to Ford where it will be combined with scheduled maintenance information, open recalls and other field service actions and un-serviced vehicle inspection items from your authorized dealer.
- **User Preferences:** Press OK to select and enter the menu. You can then scroll to select from:
  - **Auto Report:** Press OK and select on or off. Select 'On' to have SYNC automatically prompt you to run a health report at certain mileage intervals. **Note:** You must first turn this feature 'on' before you can select the mileage intervals at which you would like to be prompted.
  - **Mileage:** Press OK and scroll to select between 5,000, 7,500 or 10,000 mile intervals.

**Note:** This feature may not function properly if you have enabled caller ID blocking on your mobile phone. Before running a report, review Vehicle Health Report Privacy Notice.

### SYNC®APPLINK™ (IF EQUIPPED, U.S. ONLY)

SYNC® AppLink™ is a software application which allows you to connect to and use applications on your smartphone such as Pandora and Stitcher via your SYNC system (provided your phone is compatible with these features).

To see trouble shooting tips, available applications, and a list of supported smart phone devices, please visit [www.SyncMyRide.com](http://www.SyncMyRide.com).

#### To access from the media menu:

1. Press AUX. Media Menu will momentarily appear in the display.
2. Press MENU.

See *End User License Agreement* at the end of this book

37

## SYNC Apps and Services

3. Scroll to cycle through the following options:

- Play Menu
- Select Source
- *Media Settings*
- *Mobile Apps*
- System Settings
- *Exit Media Menu*

4. When *Mobile Apps* appears in the display, press OK to enter the menu and view a list of available applications (for example, Pandora).

5. Once started, you may then press MENU to access Media Menu.

6. Scroll to access the desired application menu (for example, Pandora) and press OK. From here, you can access the features which accompany the application such as Thumbs up, Thumbs Down, etc. For more information, please visit [www.SyncMyRide.com](http://www.SyncMyRide.com)

**Note:** You can also access by pressing  or VOICE and, when prompted, saying “Mobile Apps”. You can then say the name of the smart phone application (for example, Pandora) after the tone. Your smart phone *must* be paired and connected in order to use this feature.

### To access from the phone menu:

1. Press  or PHONE to enter the Phone Menu.
2. Scroll repeatedly until *Mobile Apps* appears in the display.
3. Press OK to enter the menu and view a list of available applications (for example, Pandora).
4. Scroll to access the desired application menu (for example, Pandora menu) and press OK. From here you can access the features which accompany the application such as Thumbs up, Thumbs down, etc. For more information, please visit [www.SyncMyRide.com](http://www.SyncMyRide.com).

**Note:** iPhone® users need to connect the phone to the USB port in order to start an application.

**Note:** If using an iPhone®, it is recommended that the phone is locked after starting the application.

## Media features

### MEDIA FEATURES WITH SYNC

SYNC® allows you to access and play music from your digital music player over the vehicle's speaker system using the system's media menu or voice commands.

You can also choose to sort and play your music by specific metadata categories such as:

- *Artists*
- Albums
- Genres
- Playlists
- Tracks
- Similar Music



### Compatibility

SYNC is capable of hosting nearly any digital media player including: iPod®, Zune™, “Plays from device” players, and most USB drives.

SYNC will also support audio formats such as MP3, WMA, WAV and ACC.

### Connecting your digital media player to SYNC® via the USB port

**Note:** If your digital media player has an On/Off switch, ensure that the device is turned On.

1. Plug the device into the vehicle's USB port.
2. Press AUX repeatedly until SYNC® USB appears in the display.
3. Depending on how many digital media files are on your connected device, Indexing may appear in the radio display until indexing is complete. You will then be taken to the Play Menu.
4. Press OK and scroll through selections of:
  - Play All
  - Albums
  - Genres
  - Playlists
  - Tracks
  - Explore USB
  - Similar Music
  - Return

See *End User License Agreement* at the end of this book

39

## Media features

5. When the desired selection appears in the display, press OK to build your desired music selection.

For more information, refer to *Accessing your play menu* later in this chapter.

### What's playing?

At any time while a track is playing, you can press  or VOICE and say, "What's playing?". SYNC® will read the metadata tags of the playing track to you (if populated).



### MEDIA VOICE COMMANDS

Press  or VOICE and when prompted, say, "USB" . You may then say any of the following:

- |   |                                     |
|---|-------------------------------------|
| • Play all                                | • Play                              |
| • Pause                                   | • What's playing?                   |
| • Play next track                         | • Play previous track               |
| • Play song <name>                        | • Search song <name>                |
| • Refine song <name>                      | • Similar music                     |
| • Play next folder <sup>2</sup>           | • Play previous folder <sup>2</sup> |
| • Autoplay on                             | • Autoplay off                      |
| • Repeat off                              | • Repeat on                         |
| • Shuffle on                              | • Shuffle off                       |
| • Play genre <name> <sup>1</sup>          | • Play playlist <name> <sup>1</sup> |
| • Play album <name> <sup>1</sup>          | • Play artist <name> <sup>1</sup>   |
| • Play track <name> <sup>1</sup>          | • Search artist <name> <sup>1</sup> |
| • Search genre <name> <sup>1</sup>        | • Search track <name> <sup>1</sup>  |
| • Search album <name> <sup>1</sup>        | • Refine album <name> <sup>1</sup>  |
| • Refine artist <name> <sup>1</sup>       | • Refine track <name> <sup>1</sup>  |
| • (Phone) (Media) (Bluetooth) Connections |                                     |

<sup>1</sup> Voice commands which are not available until indexing is complete.

<sup>2</sup> Voice commands which are only available in folder mode. For more information, refer to *Exploring the USB device* later in this chapter.

**Note:** In the above possible commands, "<name>" is a dynamic listing in that it could be the name of any desired group, artist, etc.

40      **See End User License Agreement at the end of this book**

## Media features

**Autoplay:** With this feature ON, SYNC® allows you to listen to music which has already been randomly indexed during the indexing process. With this feature OFF, SYNC® will not begin to play any of your music until all media has all been indexed.

**Note:** The larger the number of songs the system has to index, the longer indexing will take. Indexing times can vary from device to device.

**Search/Play Genre:** You can search for and play a specific genre (type) of music. SYNC® will search all the data from your indexed music and, if available, will begin to play that type of music.

**Note:** You can only play genres of music which are present in the GENRE metadata tags that you have on your digital media player.

**Similar music:** You can tell the system to play music ‘similar’ to what you are currently playing from the USB port. SYNC® will use the metadata information of each indexed song to compile a playlist for you.

**Search/play artist/track/album:** You can search for a specific artist/track or album from the music SYNC® has indexed through the USB port.

**Refine:** This allows you to ‘refine’ your previous commands. For example, if you told SYNC® to search and play all music by a certain artist, you could then tell SYNC® to “refine album” and choose a specific album from the list to view. If you then select ‘Play’, the system will only play music from that specific album.

Press  or VOICE and when prompted, say, “**Bluetooth Audio**”. You may then say any of the following:

- |  |   |
|--|---|
| <ul style="list-style-type: none"><li>• Play</li><li>• Pause</li><li>• Play previous track</li></ul> | <ul style="list-style-type: none"><li>• (Phone) (Media) (Bluetooth) Connections</li><li>• Play next track</li></ul> |
|--|---|

## Media features

### MANEUVERING THE MEDIA MENU

Below is a graphical representation of how the phone menu lays out in your system. It will be explained in more detail in this chapter, but this may help you to better visualize the menu structure.

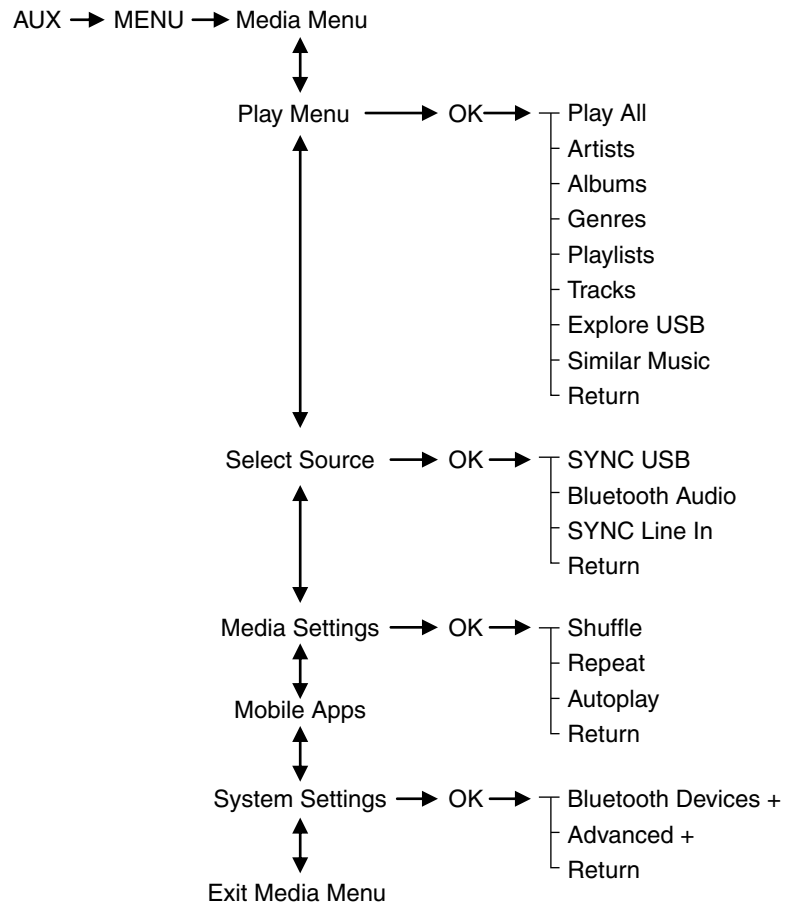

+ Denotes submenus with additional menu items

**Scrolling through the menus:** Press ▲ / ▼ to scroll through the menu options.

## Media features

### Accessing the features of your media menu

SYNC's media menu allows you to select which source you would like to listen to, how you would like to play your music (by artist, genre, shuffle, repeat, etc.), and also if you need to add, connect or delete devices.

To access your media menu:

1. Press AUX repeatedly until SYNC appears in the display.
2. Press MENU to enter the Media Menu.
3. Scroll to cycle through the following features:

**Play Menu:** Allows you to play your music by artist, album, genre, playlists, tracks, similar music or to simply, play all. You can also choose to Explore USB to view the supported digital music files on your playing device.

Refer to Play Menu later in this section for more information.

**Select Source:** Allows you to select and play music from your USB port, auxiliary input jack (line in) or stream music from your *Bluetooth* enabled phone. Press OK to select and then scroll to choose from:

- **\*USB:** Press OK to access music plugged into your USB port. SYNC will also allow you to plug in devices to charge them (if supported by your device).
- **Bluetooth Audio: This is a phone dependent feature** which allows you to stream music playing on your *Bluetooth* enabled phone. If supported by your device, you can press ◀ SEEK ▶ to access the previous/next track.
- **Line in:** Press OK to select and play music from your portable music player over the vehicle's speakers. **Note:** If you have already connected a device to the USB port, you cannot access the line in feature. Some digital media players require both USB and Line in ports to stream data and music separately.

\* Once connected, SYNC will index any readable media files. (The time required to complete this depends on the size of the media content being indexed.) If *Autoplay* is on, you can access media files randomly as they are indexed. If turned off, indexed media is not available until the indexing process is complete. SYNC is capable of indexing thousands of average size media and will notify you if the maximum indexing file size is reached.

## Media features

**Media Settings:** Allows you to choose to shuffle or repeat your music in addition to setting your Autoplay settings. Press OK to select and then scroll to choose from:

↳ • **Shuffle:** Press OK to shuffle available media files in the current playlist. **Note:** To shuffle all media tracks, you must select *Play All* in the Play Menu and then select Shuffle.

• **Repeat:** Press OK to repeat any song.

• **Autoplay:** Press OK to listen to music which has already been randomly indexed during the indexing process.

\* You may also press you can press ◀ SEEK ▶ to access the previous/next track.

**Note:** Once these selections are turned on, they will remain on until turned off. Some digital media players require both USB and Line in ports to stream data and music separately.

**Mobile Apps** (if equipped): Enables you to interact with SYNC® capable mobile applications on your smartphone. Refer to SYNC® AppLink™ in the SYNC® Apps and Services chapter in this supplement.

**Applications (if available):** You can download new software applications (if available) and then load the desired applications onto SYNC through your USB port. Please refer to [www.SyncMyRide.com](http://www.SyncMyRide.com) or [www.syncmaroute.ca](http://www.syncmaroute.ca) for more information.

**System Settings:** Allows you to access *Bluetooth* Device menu listings (add, connect, set as primary, on/off, delete) as well as Advanced menu listings (prompts, languages, defaults, master reset, install application and system information).

• Please refer to System Settings in this chapter for complete information.

**Exit Media Menu:** Press OK when this appears to exit the media menu.

### Accessing your play menu

The Play menu allows you to select and play your media by artist, album, genre, playlist, track, similar music or even to explore what is on your USB device. Ensure that your device is plugged into the USB port and is turned on.

To access:

1. Press AUX repeatedly until SYNC appears.
2. Press MENU and then press OK to access the Play Menu.

44      **See *End User License Agreement* at the end of this book**

## Media features

3. If there are no media files to access, the display will indicate there is no media. If there are media files, you will then have the following options to scroll through and select from:

**Play All:** Allows you to play all indexed media (tracks) from your playing device in flat file mode, one at a time in numerical order.

- Press OK to select. The first track title will appear in the display.

**Artists:** Allows you to sort all indexed media by artists. Once selected, the system will list and then play all artists and tracks alphabetically. If there are less than 255 indexed artist, they will be listed alphabetically in flat file mode. If there are more, they will be categorized into alphabetical categories.

1. Press OK to select. You can select to play *All Artists* or any indexed artist.
2. Scroll until the desired artist is chosen and press OK.

**Albums:** Allows you to sort all indexed media by albums. If there are less than 255 indexed albums, they will be listed alphabetically in flat file mode. If there are more, they will be organized into alphabetical categories.

1. Press OK to enter the album menu and select from playing all albums or from any individual indexed album.
2. Scroll until the desired album is chosen and press OK.

**Genres:** Allows you to sort indexed music by genre (category) type. SYNC will list the genres alphabetically in flat file mode. If there are more than 255, SYNC will automatically organize them into alphabetical categories.

- Press OK to select and then scroll to select the desired genre and press OK.

**Playlists:** Allows you to access your playlists. SYNC will list your playlists alphabetically in flat file mode. If there are more than 255, SYNC will automatically organize them into alphabetical categories.

**Note:** SYNC supports many playlist formats such as: .ASX, .M3U, .WPL, .MTP.

- Press OK to select. Then scroll to select the desired playlist and press OK.

See *End User License Agreement* at the end of this book

45

## Media features

**Tracks:** Allows you to search for and play a specific track which has been indexed. SYNC will list your tracks alphabetically in flat file mode. If there are more than 255, SYNC will automatically organize them into alphabetical categories.

- Press OK to select. Then scroll to select the desired track and press OK.

**Explore USB:** Allows you to explore through all supported digital media on your media device connected to the USB port. **Note:** When exploring, you will only be able to view media content which is compatible with SYNC. You may have other files saved with various extensions, but they will not be visible.

- Press OK to select. Then scroll to explore indexed media on your flash drive.

**Similar Music:** Allows you to play music similar to what is currently playing from the USB port. The system uses the metadata information of each song to compile a playlist for you.

- Press OK to select. The system will create a new list of similar songs and begin playing. **Note:** Your metadata tags must be populated in order for this feature to include each track.

**Note:** With certain playing devices, if your metadata tags are not populated, the tracks won't be available in voice recognition, play menu or similar music. However, if you place these tracks onto your playing device in "Mass Storage Device Mode", they will be available in voice recognition, play menu browsing and similar music. "Unknown" will be placed into any unpopulated metadata tag.

**Return:** Press OK to exit the current menu.

## System settings

System settings provide access to your Bluetooth Devices and Advanced menu features.

The Bluetooth Devices menu allows you to add, connect and delete a device as turn the *Bluetooth* feature on and off.

Your Advanced menu allows you to access and set prompts, languages, defaults and perform a master reset.

## Media features

See the following sections for more information on these menus as well as the following graphic for the menu layout.

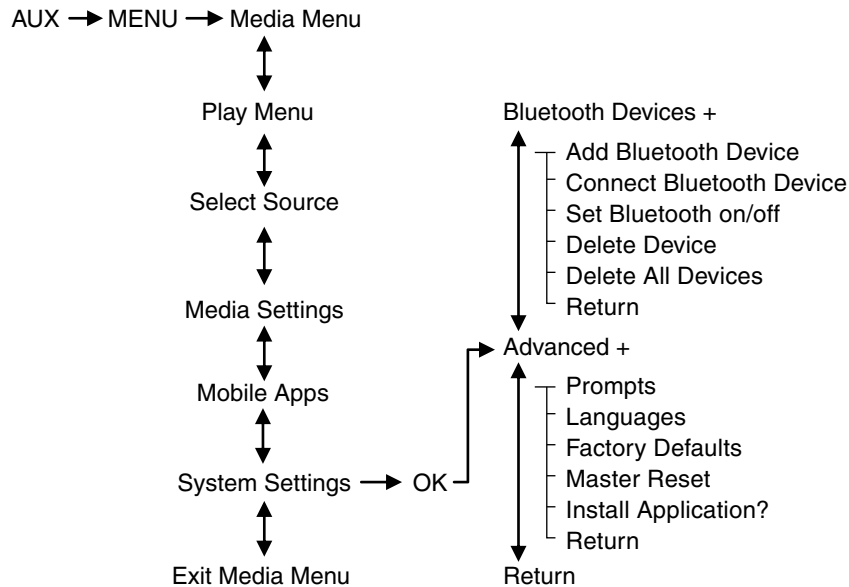

**Scrolling through the menus:** Press ▲ / ▼ on your audio system to scroll through the menu options. Depending on your system, you may also be able to press ◀ / ▶ or turn the TUNE knob.

### ***Bluetooth Device menu options***

This menu allows you to add, connect and delete devices as well as turn *Bluetooth* on and off.

To access:

1. Press AUX repeatedly until SYNC appears.
2. Press MENU and then press OK to access the Media Menu.
3. Scroll until System Settings appears and select OK.
4. Scroll until Bluetooth Devices appears.
5. Press OK and then scroll to select from the following:

See *End User License Agreement* at the end of this book

## Media features

**Add Bluetooth Device: This is a speed dependent feature** which allows you to pair additional devices to the system.

1. Press OK to select and press OK again when Find SYNC appears in the display.
2. Follow the directions in your phone's user guide to put your phone into discovery mode. A six digit PIN will appear in the display.
3. When prompted on your phone's six digit display, enter the PIN. You can now change SYNC sources to BT Audio and stream music from your device.

**Connect Bluetooth Device:** Allows you to connect a previously paired *Bluetooth* enabled phone.

1. Press OK to select and view a list of devices.
2. Scroll until the desired device is chosen and press OK to connect the device.

**Set Bluetooth On/Off:** Allows you to turn the *Bluetooth* feature on /off.

- Press OK and scroll to toggle between On and Off. When the desired selection is chosen, press OK.

**Note:** Turning Off *Bluetooth* will disconnect all *Bluetooth* devices and deactivate all *Bluetooth* features.

**Delete Device:** Allows you to delete a paired media device.

- Press OK and scroll to select the device. Press OK to confirm.

**Delete All Devices:** Allows you to delete all previously paired devices.

- Press OK to select.

**Return:** Press OK to exit the current menu.

### **Advanced menu options**

This menu allows you to access settings such as prompts, language, performing a master reset as well as returning to factory defaults.

To access:

1. Press AUX repeatedly until SYNC appears.
2. Press MENU and then press OK to access the Media Menu.
3. Scroll until System Settings appears and select OK.
4. Scroll until Advanced appears.

48      **See *End User License Agreement* at the end of this book**

## Media features

5. Press OK and then scroll to select from the following:

**Prompts:** Prompts from SYNC can help guide you via questions, helpful hints or ask you for a specific action. To turn these prompts on or off:

- ↳ 1. Press OK to select and scroll to select between on or off.
- 2. Press OK when the desired selection appears in the display.  
SYNC will take you back to the Advanced menu.

**Languages:** Allows you to choose from three languages: English, Francais and Espanol. Once selected, all of SYNC's radio displays and prompts will be in the selected language.

- ↳ 1. Press OK to select and then scroll through English, Francais and Espanol.
- 2. Press OK when the desired selection appears in the display.

**Note:** If you change the language setting, the display will indicate that the system is updating. When complete, SYNC will take you back to the Advanced menu.

**Factory Defaults:** Allows you to return to the factory default settings. This selection will NOT erase your indexed information (phonebook, call history, text messages and paired devices).

- 1. Press OK to select and then press OK again when Restore Defaults? appears in the display.
- 2. Press OK to confirm.

**Master Reset:** Allows you to completely erase ALL information stored on SYNC (all phonebook, call history, text messages and all paired devices) and return to the factory default settings.

- Press OK to select. The display will indicate when complete and SYNC will take you back to the Advanced menu.

**Application (if available):** You can download new software application (if available) and then load the desired applications onto SYNC through your USB port. Refer to the web site for more information.

**Return :** Press OK to exit the current menu.

## Troubleshooting

### TROUBLESHOOTING

Your SYNC® system is easy to use. However, should questions arise, please refer to the tables below as well as the *Helpful Hints* section that follows.

Use the website at any time to check your phone's compatibility, register your account and set preferences as well as access a customer representative via an on-line chat (during certain hours). Visit [www.SyncMyRide.com](http://www.SyncMyRide.com) or [www.syncmaroute.ca](http://www.syncmaroute.ca) for more information.

Phone issues		
Issue	Possible Cause(s)	Possible Solution(s)
There seems to be a lot of background noise during a phone call.	The audio control settings on your phone may be affecting the performance of SYNC.	Review your phone's user guide regarding audio adjustments.
During a call, I can hear the other person but they can't hear me.	Possible phone malfunction.	Try turning off the device, resetting or removing the battery of the device and try again.
SYNC is not able to download my phonebook.	<ul style="list-style-type: none"> <li>• This is a phone dependent feature.</li> <li>• Possible phone malfunction.</li> </ul>	<ul style="list-style-type: none"> <li>• Go to the web site to review your phone's compatibility.</li> <li>• Try turning off the device, resetting the device or removing the battery of the device, then try again.</li> <li>• Try "pushing" your phonebook contacts to SYNC by using the Add Contacts feature.</li> <li>• Use the "SYNCmyphone" feature available on the web site.</li> </ul>

## Troubleshooting

<b>Phone issues</b>		
<b>Issue</b>	<b>Possible Cause(s)</b>	<b>Possible Solution(s)</b>
The system says “Phonebook Downloaded” but my phonebook in SYNC is empty or is missing contacts.	Limitations on your phone’s capability.	<ul style="list-style-type: none"> <li>• Try ‘pushing’ your phonebook contacts to SYNC by using the Add Contacts feature.</li> <li>• If the missing contacts are stored on your SIM card, try moving them to the device memory.</li> </ul> Remove any pictures or special ring tones associated with the missing contact.
I’m having trouble connecting my phone to SYNC.	<ul style="list-style-type: none"> <li>• This is a phone dependent feature.</li> <li>• Possible phone malfunction.</li> </ul>	<ul style="list-style-type: none"> <li>• Go to the web site to review your phone’s compatibility.</li> <li>• Try turning off the device, resetting the device or removing the battery of the device then try again.</li> <li>• Try deleting your device from SYNC, and deleting SYNC on your device then try to pair again.</li> <li>• Check the security and “auto accept/prompt always” settings relative to the SYNC <i>Bluetooth</i> connection on your phone.</li> <li>• Update your device’s software firmware.</li> <li>• Turn off the Auto phonebook download setting.</li> </ul>
Text messaging is not working on SYNC.	<ul style="list-style-type: none"> <li>• This is a phone dependent feature.</li> <li>• Possible phone malfunction.</li> </ul>	<ul style="list-style-type: none"> <li>• Go to the website to review your phone’s compatibility.</li> <li>• Try turning off the device, resetting the device or removing the battery of the device then try again.</li> </ul>

See *End User License Agreement* at the end of this book

## Troubleshooting

USB/Media issues		
Issue	Possible Cause(s)	Possible Solution(s)
I'm having trouble connecting my device.	Possible device malfunction.	<ul style="list-style-type: none"> <li>• Try turning off the device, resetting the device or removing the battery of the device and try to connect your device again.</li> <li>• Ensure that you are using the manufacturer's cable.</li> <li>• Ensure that the USB cable is properly inserted into your device and the USB port in the vehicle.</li> <li>• Ensure that your device does not have an auto—install program or active security settings.</li> </ul>
SYNC does not recognize my device when I turn on the car.	This is a device limitation.	Ensure that you are not leaving your device in your vehicle during very hot or cold temperatures.
<i>Bluetooth</i> audio won't stream.	<ul style="list-style-type: none"> <li>• This is a phone dependent feature.</li> <li>• The device is not connected.</li> </ul>	<ul style="list-style-type: none"> <li>• Ensure that the device is connected to SYNC and that you have pressed play on your device.</li> </ul>
SYNC doesn't recognize music that is on my device.	<ul style="list-style-type: none"> <li>• Your music files may not contain the proper artist, song title, album or genre information. The file may be corrupted. The song may have copyright protection which does not allow it to play.</li> </ul>	<ul style="list-style-type: none"> <li>• Ensure that all song details are populated.</li> <li>• Some devices require you to change the USB settings from mass storage to MTP class.</li> </ul>

## Troubleshooting

<b>Vehicle Health Report/Services (Traffic, Directions and Information) issues</b>		
<b>Issue</b>	<b>Possible Cause(s)</b>	<b>Possible Solution(s)</b>
I received a text that the Vehicle Health Report isn't activated.	Your account may not be activated on the web site or you may have the wrong VIN (vehicle identification number) listed.	<ul style="list-style-type: none"> <li>• This is a free feature, but you must first register online to use it. Ensure that you have registered your account on the website.</li> <li>• Ensure that your VIN is correctly listed in your account.</li> </ul>
I'm unable to retrieve the report on the web site, or I received a system error.	The preferred dealer information did not load correctly.	When you register your account, you must list a preferred dealer. If one is already listed, try selecting another dealer and logging back out. Then, log back in and change it back to your preferred dealer and retrieve the report.
I'm unable to submit a report.	<ul style="list-style-type: none"> <li>• This could be due to your phone's compatibility, bad signal strength or your phone may not be activated on the web site.</li> </ul>	<ul style="list-style-type: none"> <li>• Update your mobile number in your account on the web site.</li> <li>• Ensure that you have full signal strength and that your <i>Bluetooth</i> volume level has been turned up.</li> <li>• Try deleting your phone and performing a clean pairing.</li> </ul>

See *End User License Agreement* at the end of this book

53

## Troubleshooting

<b>Vehicle Health Report/Services (Traffic, Directions and Information) issues</b>		
<b>Issue</b>	<b>Possible Cause(s)</b>	<b>Possible Solution(s)</b>
I heard a commercial when I tried to use Traffic, Directions and Information.	<ul style="list-style-type: none"><li>• The phone in use is not activated.</li><li>• Your phone has ID blocker active.</li></ul>	<ul style="list-style-type: none"><li>• This is a free feature, but you must first register online to use it. Ensure that you have registered your account on the web site.</li><li>• Turn off ID blocker on your phone as the system recognizes you by your phone number. Ensure that the currently connected phone is the same one that is registered on your SyncMyRide account.</li></ul>

## Troubleshooting

<b>Voice command issues</b>		
<b>Issue</b>	<b>Possible Cause(s)</b>	<b>Possible Solution(s)</b>
SYNC does not understand what I am saying.	<ul style="list-style-type: none"> <li>• You may be using the wrong voice commands.</li> <li>• You may be speaking too soon or at the wrong time.</li> </ul>	<ul style="list-style-type: none"> <li>• Review the Phone voice commands and the Media voice commands at the beginning of their respective chapters.</li> <li>• Be aware that SYNC's microphone is either in your rear mirror or in the headliner just above the windshield.</li> </ul>
SYNC does not understand the name of a song or artist.	<ul style="list-style-type: none"> <li>• You may be using the wrong voice commands.</li> <li>• You may not be saying the name exactly as it is saved.</li> <li>• The system may not be "reading" the name the same way you are saying it.</li> </ul>	<ul style="list-style-type: none"> <li>• Review the media voice commands at the beginning of the media chapter.</li> <li>• Say the song or artist exactly as they are listed. If you say, "Play Artist Prince", the system will not play music by Prince and the Revolution or Prince and the New Power Generation.</li> <li>• Ensure that you are saying the complete title such as "California remix featuring Jennifer Nettles".</li> <li>• If the songs are saved in all CAPS, you will have to spell them. LOLA will require you to say, " Play L-O-L-A"</li> <li>• Don't use special characters in the title as the system will not recognize them.</li> </ul>



See *End User License Agreement* at the end of this book

55



## Troubleshooting

Voice command issues		
Issue	Possible Cause(s)	Possible Solution(s)
SYNC does not understand or is calling the wrong contact when I want to make a call.	<ul style="list-style-type: none"> <li>You may be using the wrong voice commands.</li> <li>You may not be saying the name exactly as it is saved.</li> <li>Contacts in your phonebook may be very short and similar, or they may contain special characters.</li> <li>Your phonebook contacts may be saved in CAPS.</li> </ul>	<ul style="list-style-type: none"> <li>Review the phone voice commands at the beginning of the phone chapter.</li> <li>Ensure that you are saying the contacts exactly as they are listed. For example, if a contact is saved as Joe Wilson, say, "Call Joe Wilson".</li> <li>The system does better if you list full names such as "Joe Wilson" rather than "Joe".</li> <li>Don't use special characters such as 123 or ICE as the system will not recognize them.</li> <li>If contacts are saved in CAPS, you will have to spell them. JAKE will require you to say, "Call J-A-K-E."</li> </ul>

### Helpful Hints

- Ensure that the interior of the vehicle is as quiet as possible. Wind noise from open windows and road vibrations may prevent the system from correctly recognizing spoken voice commands.
- Ensure that you are speaking naturally and without any large pauses between words.
- After you press VOICE or  to begin a voice session, wait until the prompt sounds and *Listening* appears in the display. Anything spoken prior to this will not register with the system.
- You can, at any time, interrupt the system while it is speaking by pressing VOICE or  during an active voice session. The system will respond with a listening prompt and allow you to speak a command.

## Troubleshooting

- For a list of available voice commands, you can press VOICE or  and say, “Help” after the tone. The system will audibly list voice commands available in your current mode.
- The system’s microphone is either located in your rear view mirror or in the headliner just above your windshield. Ensure that the microphone area is kept free of obstructions.
- To better understand how the system interprets your phone book contacts, select a contact and then scroll until *Speak this* is selected and press OK. The system will read the contact and you can better understand how to say the contact for the next time.
- To better understand how the system interprets your media titles, when the desired selection is playing, press VOICE or , and when prompted, say “What’s playing?”. The system will read the title to you so that you will know how to say the selection so that the system will understand.
- For more information, refer to *Using your voice recognition system*.

### **SYNC® customer support**

If your questions are still not resolved, please contact SYNC® customer support, available Monday through Saturday: 8:30am-8:00pm EST. You can also access on-line support on the web site during these same hours.

**Note:** Times are subject to change due to holidays.

In the United States, call: 1-888-270-1055

In Canada, call: 1-800-565-3673

## End user license agreement

### **SYNC® END USER LICENSE AGREEMENT (EULA)**

- You have acquired a device (“DEVICE”) that includes software licensed by FORD MOTOR COMPANY from an affiliate of Microsoft Corporation (“MS”). Those installed software products of MS origin, as well as associated media, printed materials, and “online” or electronic documentation (“MS SOFTWARE”) are protected by international intellectual property laws and treaties. The MS SOFTWARE is licensed, not sold. All rights reserved.
- The MS SOFTWARE may interface with and/or communicate with, or may be later upgraded to interface with and/or communicate with additional software and/or systems provided by FORD MOTOR COMPANY. The additional software and systems of FORD MOTOR COMPANY origin, as well as associated media, printed materials, and “online” or electronic documentation (“FORD SOFTWARE”) are protected by international intellectual property laws and treaties. The FORD SOFTWARE is licensed, not sold. All rights reserved.
- The MS SOFTWARE and/or FORD SOFTWARE may interface with and/or communicate with, or may be later upgraded to interface with and/or communicate with additional software and/or systems provided by third party software and service suppliers. The additional software and services of third party origin, as well as associated media, printed materials, and “online” or electronic documentation (“THIRD PARTY SOFTWARE”) are protected by international intellectual property laws and treaties. The THIRD PARTY SOFTWARE is licensed, not sold. All rights reserved.
- The MS SOFTWARE, FORD SOFTWARE and THIRD PARTY SOFTWARE hereinafter collectively and individually will be referred to as “SOFTWARE.”

**IF YOU DO NOT AGREE TO THIS END USER LICENSE AGREEMENT (“EULA”), DO NOT USE THE DEVICE OR COPY THE SOFTWARE. ANY USE OF THE SOFTWARE, INCLUDING BUT NOT LIMITED TO USE ON THE DEVICE, WILL CONSTITUTE YOUR AGREEMENT TO THIS EULA (OR RATIFICATION OF ANY PREVIOUS CONSENT).**

**GRANT OF SOFTWARE LICENSE:** This EULA grants you the following license:

- You may use the SOFTWARE as installed on the DEVICE and as otherwise interfacing with systems and/or services provide by or through FORD MOTOR COMPANY or its third party software and service providers.

58

## End user license agreement

### DESCRIPTION OF OTHER RIGHTS AND LIMITATIONS:

- **Speech Recognition:** If the SOFTWARE includes speech recognition component(s), you should understand that speech recognition is an inherently statistical process and that recognition errors are inherent in the process. Neither FORD MOTOR COMPANY nor its suppliers shall be liable for any damages arising out of errors in the speech recognition process.
- **Limitations on Reverse Engineering, Decompilation and Disassembly:** You may not reverse engineer, decompile, or disassemble nor permit others to reverse engineer, decompile or disassemble the SOFTWARE, except and only to the extent that such activity is expressly permitted by applicable law notwithstanding this limitation.
- **Limitations on Distributing, Copying, Modifying and Creating Derivative Works:** You may not distribute, copy, make modifications to or create derivative works based on the SOFTWARE, except and only to the extent that such activity is expressly permitted by applicable law notwithstanding this limitation.
- **Single EULA:** The end user documentation for the DEVICE and related systems and services may contain multiple EULAs, such as multiple translations and/or multiple media versions (e.g., in the user documentation and in the software). Even if you receive multiple EULAs, you are licensed to use only one (1) copy of the SOFTWARE.
- **SOFTWARE Transfer:** You may permanently transfer your rights under this EULA only as part of a sale or transfer of the DEVICE, provided you retain no copies, you transfer all of the SOFTWARE (including all component parts, the media and printed materials, any upgrades, and, if applicable, the Certificate(s) of Authenticity), and the recipient agrees to the terms of this EULA. If the SOFTWARE is an upgrade, any transfer must include all prior versions of the SOFTWARE.
- **Termination:** Without prejudice to any other rights, FORD MOTOR COMPANY or MS may terminate this EULA if you fail to comply with the terms and conditions of this EULA.
- **Security Updates/Digital Rights Management:** Content owners use the WMDRM technology included in your DEVICE to protect their intellectual property, included copyrighted content. Portions of the SOFTWARE on your DEVICE use WMDRM software to access WMDRM-protected content. If the WMDRM software fails to protect the content, content owners may ask Microsoft to revoke the

## End user license agreement

SOFTWARE's ability to use WMDRM to play or copy protected content. This action does not affect unprotected content. When your DEVICE downloads licenses for protected content, you agree that Microsoft may include a revocation list with the licenses. Content owners may require you to upgrade the SOFTWARE on your DEVICE to access their content. If you decline an upgrade, you will not be able to access content that requires the upgrade.

- **Consent to Use of Data:** You agree that MS, Microsoft Corporation, FORD MOTOR COMPANY, third party software and systems suppliers, their affiliates and/or their designated agent may collect and use technical information gathered in any manner as part of product support services related to the SOFTWARE or related services. MS, Microsoft Corporation, FORD MOTOR COMPANY, third party software and services suppliers, their affiliates and/or their designated agent may use this information solely to improve their products or to provide customized services or technologies to you. MS, Microsoft Corporation, FORD MOTOR COMPANY, third party software and systems suppliers, their affiliates and/or their designated agent may disclose this information to others, but not in a form that personally identifies you.
- **Internet-Based Services Components:** The SOFTWARE may contain components that enable and facilitate the use of certain Internet-based services. You acknowledge and agree that MS, Microsoft Corporation, FORD MOTOR COMPANY, third party software and service suppliers, their affiliates and/or their designated agent may automatically check the version of the SOFTWARE and/or its components that you are utilizing and may provide upgrades or supplements to the SOFTWARE that may be automatically downloaded to your DEVICE.
- **Additional Software/Services:** The SOFTWARE may permit FORD MOTOR COMPANY, third party software and service suppliers, MS, Microsoft Corporation, their affiliates and/or their designated agent to provide or make available to you SOFTWARE updates, supplements, add-on components, or Internet-based services components of the SOFTWARE after the date you obtain your initial copy of the SOFTWARE ("Supplemental Components").

If FORD MOTOR COMPANY or third party software and services suppliers provide or make available to you Supplemental Components and no other EULA terms are provided along with the Supplemental Components, then the terms of this EULA shall apply.

If MS, Microsoft Corporation, their affiliates and/or their designated agent make available Supplemental Components, and no other EULA terms are

60

## End user license agreement

provided, then the terms of this EULA shall apply, except that the MS, Microsoft Corporation or affiliate entity providing the Supplemental Component(s) shall be the licensor of the Supplemental Component(s).

FORD MOTOR COMPANY, MS, Microsoft Corporation, their affiliates and/or their designated agent reserve the right to discontinue without liability any Internet-based services provided to you or made available to you through the use of the SOFTWARE.

- **Links to Third Party Sites:** The MS SOFTWARE may provide you with the ability to link to third party sites through the use of the SOFTWARE. The third party sites are not under the control of MS, Microsoft Corporation, their affiliates and/or their designated agent. Neither MS nor Microsoft Corporation nor their affiliates nor their designated agent are responsible for (i) the contents of any third party sites, any links contained in third party sites, or any changes or updates to third party sites, or (ii) webcasting or any other form of transmission received from any third party sites. If the SOFTWARE provides links to third party sites, those links are provided to you only as a convenience, and the inclusion of any link does not imply an endorsement of the third party site by MS, Microsoft Corporation, their affiliates and/or their designated agent.
- **Obligation to Drive Responsibly:** You recognize your obligation to drive responsibly and keep attention on the road. You will read and abide with the DEVICE operating instructions particularly as they pertain to safety and assumes any risk associated with the use of the DEVICE.

**UPGRADES AND RECOVERY MEDIA:** If the SOFTWARE is provided by FORD MOTOR COMPANY separate from the DEVICE on media such as a ROM chip, CD ROM disk(s) or via web download or other means, and is labeled "For Upgrade Purposes Only" or "For Recovery Purposes Only" you may install one (1) copy of such SOFTWARE onto the DEVICE as a replacement copy for the existing SOFTWARE, and use it in accordance with this EULA, including any additional EULA terms accompanying the upgrade SOFTWARE.

**INTELLECTUAL PROPERTY RIGHTS:** All title and intellectual property rights in and to the SOFTWARE (including but not limited to any images, photographs, animations, video, audio, music, text and "applets," incorporated into the SOFTWARE), the accompanying printed materials, and any copies of the SOFTWARE, are owned by MS, Microsoft Corporation, FORD MOTOR COMPANY, or their affiliates or suppliers. The SOFTWARE is licensed, not sold. You may not copy the printed materials accompanying the SOFTWARE. All title and intellectual

## End user license agreement

property rights in and to the content which may be accessed through use of the SOFTWARE is the property of the respective content owner and may be protected by applicable copyright or other intellectual property laws and treaties. This EULA grants you no rights to use such content. All rights not specifically granted under this EULA are reserved by MS, Microsoft Corporation, FORD MOTOR COMPANY, third party software and service providers, their affiliates and suppliers. Use of any on-line services which may be accessed through the SOFTWARE may be governed by the respective terms of use relating to such services. If this SOFTWARE contains documentation that is provided only in electronic form, you may print one copy of such electronic documentation.

**EXPORT RESTRICTIONS:** You acknowledge that the SOFTWARE is subject to U.S. and European Union export jurisdiction. You agree to comply with all applicable international and national laws that apply to the SOFTWARE, including the U.S. Export Administration Regulations, as well as end-user, end-use and destination restrictions issued by U.S. and other governments. For additional information, see <http://www.microsoft.com/exporting/>.

**TRADEMARKS:** This EULA does not grant you any rights in connection with any trademarks or service marks of FORD MOTOR COMPANY, MS, Microsoft Corporation, third party software or service providers, their affiliates or suppliers.

**PRODUCT SUPPORT:** Product support for the SOFTWARE is not provided by MS, its parent corporation Microsoft Corporation, or their affiliates or subsidiaries. For product support, please refer to FORD MOTOR COMPANY instructions provided in the documentation for the DEVICE. Should you have any questions concerning this EULA, or if you desire to contact FORD MOTOR COMPANY for any other reason, please refer to the address provided in the documentation for the DEVICE.

**No Liability for Certain Damages:** EXCEPT AS PROHIBITED BY LAW, FORD MOTOR COMPANY, ANY THIRD PARTY SOFTWARE OR SERVICES SUPPLIERS, MS, MICROSOFT CORPORATION AND THEIR AFFILIATES SHALL HAVE NO LIABILITY FOR ANY INDIRECT, SPECIAL, CONSEQUENTIAL OR INCIDENTAL DAMAGES ARISING FROM OR IN CONNECTION WITH THE USE OR PERFORMANCE OF THE SOFTWARE. THIS LIMITATION SHALL APPLY EVEN IF ANY REMEDY FAILS OF ITS ESSENTIAL PURPOSE. IN NO EVENT SHALL MS, MICROSOFT CORPORATION AND/OR THEIR AFFILIATES BE LIABLE FOR ANY AMOUNT IN EXCESS OF U.S. TWO HUNDRED FIFTY DOLLARS (U.S.\$250.00).

- THERE ARE NO WARRANTIES OTHER THAN THOSE THAT MAY EXPRESSLY BE PROVIDED FOR YOUR NEW VEHICLE.

62

## End user license agreement

### END USER NOTICE

#### **MICROSOFT® WINDOWS® MOBILE FOR AUTOMOTIVE IMPORTANT SAFETY INFORMATION**

This system Ford SYNC™ contains software that is licensed to Manufacturer FORD MOTOR COMPANY by an affiliate of Microsoft Corporation pursuant to a license agreement. Any removal, reproduction, reverse engineering or other unauthorized use of the software from this system in violation of the license agreement is strictly prohibited and may subject you to legal action.

#### **Read and follow instructions**

Before using your Windows Automotive-based system, read and follow all instructions and safety information provided in this end user manual (“User’s Guide”). Not following precautions found in this User’s Guide can lead to an accident or other serious consequences.

#### **Keep User’s Guide in Vehicle**

When kept in the vehicle, the User’s Guide will be a ready reference for you and other users unfamiliar with the Windows Automotive-based system. Please make certain that before using the system for the first time, all persons have access to the User’s Guide and read its instructions and safety information carefully.



**WARNING:** Operating certain parts of this system while driving can distract your attention away from the road, and possibly cause an accident or other serious consequences. Do not change system settings or enter data non-verbally (using your hands) while driving. Stop the vehicle in a safe and legal manner before attempting these operations. This is important since while setting up or changing some functions you might be required to distract your attention away from the road and remove your hands from the wheel.

## End user license agreement

### GENERAL OPERATION

#### Voice Command Control

Functions within the Windows Automotive-based system may be accomplished using only voice commands. Using voice commands while driving allows you to operate the system without removing your hands from the wheel.

#### Prolonged Views of Screen

Do not access any function requiring a prolonged view of the screen while you are driving. Pull over in a safe and legal manner before attempting to access a function of the system requiring prolonged attention. Even occasional short scans to the screen may be hazardous if your attention has been diverted away from your driving task at a critical time.

#### Volume Setting

Do not raise the volume excessively. Keep the volume at a level where you can still hear outside traffic and emergency signals while driving. Driving while unable to hear these sounds could cause an accident.

#### Use of Speech Recognition Functions

Speech recognition software is inherently a statistical process which is subject to errors. It is your responsibility to monitor any speech recognition functions included in the system and address any errors.

### GLOSSARY OF TERMS

**Autoplay:** With Autoplay turned ON, SYNC® allows you to listen to music which has already been randomly indexed during the indexing process. With Autoplay turned off, the chosen music will not begin to play until all of the music has been indexed by SYNC®. Depending on the size of the material, this may take a few minutes.

**Bluetooth enabled cellular phone:** Any cellular phone which has the *Bluetooth* wireless technology which will enable the phone to connect with SYNC® and exchange information wirelessly.

**Digital media player / USB Device:** This is a generic term used to signify any of the following media devices: iPod®, Zune™, “Plays from device” players, and most USB drives (thumb drives, flash drives, PEN drives, etc.)

**Discoverable mode:** A mode which allows other *Bluetooth* enabled devices to find your *Bluetooth* enabled device.

## End user license agreement

**Discovery mode:** A mode which allows your *Bluetooth* enabled device to search for other 'discoverable' *Bluetooth* enabled devices.

**In-band ringing:** This is a phone dependent feature. If your *Bluetooth* enabled cellular phone supports this feature, SYNC® can play your ring tone during incoming calls.

**Indexing:** A process in which SYNC® builds a voice recognition grammar for the media content of your digital media player. While indexing, SYNC® will play already indexed media if Autoplay is on. However, voice recognition is not available for the media until the indexing process is complete.

**Metadata:** Descriptive tags embedded in your digital media which provide SYNC® with information such as ARTIST, ALBUM, GENRE and TRACK.

**Pairing:** To use your *Bluetooth* enabled cellular phone with SYNC®, you must go through a pairing (bonding) process. "Pairing" is a special process used when two devices connect for the first time. The pairing process is used to generate a link key that is used for authentication purposes during subsequent *Bluetooth* connections between the two devices.

**PIN (Personal Identification number):** This six digit number (sometimes referred to as a passkey) will be shown in the radio display during the pairing process with your *Bluetooth* enabled device. You do not need to write down this number as it will only be used for that specific pairing procedure.

## Index

- 911 Assist™ .....33
- A**
- Accessing call history/phone book during active call .....15
- Accessing your media menu features .....43
- Accessing your phone menu features .....19
- Active call menu options .....15
- Advanced menu options .....27, 48
- Advanced menu options (prompts, languages, defaults, master reset, installing applications) .....27
- AppLink™ .....37
- C**
- Connecting a digital media player to SYNC® .....39
- E**
- End user license agreement .....58
- J**
- Joining two calls (multiparty/conference call) .....15
- M**
- Making and receiving calls .....14
- Media Bluetooth menu options (adding, connecting, deleting, turning on/off) .....47
- Media menu layout .....42
- P**
- Pairing other phones .....11
- Pairing your phone for the first time .....10
- Phone Bluetooth menu options (adding, connecting, deleting, turning on/off) .....25
- Phone dependent features .....10
- Phone menu layout .....18
- Phone redial .....19
- Playing music (by artist, album, genre, playlist, tracks, similar) .....44
- Privacy information .....5
- Putting a call on/off hold .....15
- R**
- Receiving a text message .....21
- S**
- Safety information .....5
- Selecting your media source (USB, Line in, BT audio) .....43
- SYNC® AppLink™ .....37
- SYNC® customer support .....57
- SYNC® Services .....29
- T**
- Text messaging .....21
- Text messaging (sending, downloading, deleting) .....21, 23
- Traffic, Directions and Information .....29

## Index

<b>U</b>	
Using privacy mode .....	15
Using the quick dial feature .....	14
<b>V</b>	
Vehicle health report .....	36
<b>W</b>	
Voice commands in media mode .....	40
Voice commands in phone mode .....	12
<b>W</b>	
What's playing? .....	40



[www.SyncMyRide.com](http://www.SyncMyRide.com)  
[www.syncmaroute.ca](http://www.syncmaroute.ca)  
[www.fordowner.com](http://www.fordowner.com)  
[www.ford.ca](http://www.ford.ca)  
[www.lincolnowner.com](http://www.lincolnowner.com)

September 2011  
Second Printing  
Supplement  
SYNC  
Litho in U.S.A.



CL2J 19A285 AA

