



lincolnowner.com



lincolncanada.com



May 2014  
First Printing  
Owner's Manual  
MKZ Hybrid  
Litho in U.S.A.

FH6J19A321 EA



2015 MKZ HYBRID Owner's Manual



2015 MKZ HYBRID

Owner's Manual



THE LINCOLN MOTOR COMPANY

The information contained in this publication was correct at the time of going to print. In the interest of continuous development, we reserve the right to change specifications, design or equipment at any time without notice or obligation. No part of this publication may be reproduced, transmitted, stored in a retrieval system or translated into any language in any form by any means without our written permission. Errors and omissions excepted.

© Ford Motor Company 2014

All rights reserved.

Part Number: 20140430184450



# Table of Contents

## Introduction

About This Manual.....	7
Symbols Glossary.....	7
Data Recording.....	9
California Proposition 65.....	11
Perchlorate.....	12
Lincoln Automotive Financial Services.....	12
Replacement Parts Recommendation.....	12
Special Notices.....	13
Mobile Communications Equipment.....	13
Export Unique Options.....	14

## Child Safety

General Information.....	15
Installing Child Seats.....	17
Booster Seats.....	26
Child Seat Positioning.....	28
Child Safety Locks.....	30

## Safety Belts

Principle of Operation.....	32
Fastening the Safety Belts.....	33

Safety Belt Height Adjustment.....	37
Safety Belt Warning Lamp and Indicator Chime.....	37
Safety Belt Minder.....	38
Child Restraint and Safety Belt Maintenance.....	40

## Personal Safety System™

Personal Safety System™.....	42
------------------------------	----

## Supplementary Restraints System

Principle of Operation.....	43
Driver and Passenger Airbags.....	44
Front Passenger Sensing System.....	45
Side Airbags.....	48
Driver and Passenger Knee Airbags.....	49
Side Curtain Airbags.....	49
Crash Sensors and Airbag Indicator.....	51
Airbag Disposal.....	52

## Keys and Remote Controls

General Information on Radio Frequencies.....	53
--	----

Remote Control.....	54
Replacing a Lost Key or Remote Control.....	58

## MyKey™

Principle of Operation.....	59
Creating a MyKey.....	60
Clearing All MyKeys.....	60
Checking MyKey System Status.....	62
Using MyKey With Remote Start Systems.....	63
MyKey Troubleshooting.....	63

## Locks

Locking and Unlocking.....	65
Keyless Entry.....	70
Interior Luggage Compartment Release.....	73

## Security

Passive Anti-Theft System.....	75
Anti-Theft Alarm.....	76

# Table of Contents

---

## Steering Wheel

Adjusting the Steering Wheel.....	78
Audio Control.....	79
Voice Control.....	80
Cruise Control.....	80
Information Display Control.....	80
Heated Steering Wheel.....	81

## Wipers and Washers

Windshield Wipers.....	82
Autowipers.....	83
Windshield Washers.....	84

## Lighting

Lighting Control.....	85
Autolamps.....	86
Instrument Lighting Dimmer.....	86
Headlamp Exit Delay.....	87
Daytime Running Lamps.....	87
Automatic High Beam Control.....	88
Adaptive Headlamps.....	89
Direction Indicators.....	90
Interior Lamps.....	90

## Windows and Mirrors

Power Windows.....	93
Global Opening and Closing.....	94
Exterior Mirrors.....	94
Interior Mirror.....	96
Sun Visors.....	97
Sun Shades.....	97
Moonroof.....	98

## Instrument Cluster

Gauges.....	100
Warning Lamps and Indicators.....	103
Audible Warnings and Indicators.....	107

## Information Displays

General Information.....	109
Information Messages.....	120

## Climate Control

Automatic Climate Control.....	139
Hints on Controlling the Interior Climate.....	141
Heated Windows and Mirrors.....	142

Cabin Air Filter.....	142
Remote Start.....	143

## Seats

Sitting in the Correct Position.....	144
Head Restraints.....	144
Power Seats.....	146
Memory Function.....	149
Rear Seats.....	150
Heated Seats.....	151
Climate Controlled Seats.....	153
Rear Seat Armrest.....	154

## Universal Garage Door Opener

Universal Garage Door Opener.....	155
-----------------------------------	-----

## Auxiliary Power Points

Auxiliary Power Points.....	160
-----------------------------	-----

## Storage Compartments

Center Console.....	162
Overhead Console.....	162

# Table of Contents

---

## Starting and Stopping the Engine

General Information.....	163
Keyless Starting.....	163
Starting a Gasoline Engine.....	164
Engine Block Heater.....	166

## Unique Driving Characteristics

Hybrid Electric Vehicle.....	168
------------------------------	-----

## Fuel and Refueling

Safety Precautions.....	174
Fuel Quality.....	175
Running Out of Fuel.....	175
Refueling.....	178
Fuel Consumption.....	180
Emission Control System.....	181

## High Voltage Battery

General Information.....	184
High Voltage Battery Cut-Off Switch.....	185

## Transmission

Automatic Transmission.....	187
-----------------------------	-----

## Brakes

General Information.....	192
Hints on Driving With Anti-Lock Brakes.....	193
Electric Parking Brake.....	193
Hill Start Assist.....	195

## Traction Control

Principle of Operation.....	197
Using Traction Control.....	197

## Stability Control

Principle of Operation.....	199
Using Stability Control.....	200

## Parking Aids

Parking Aid.....	201
Active Park Assist.....	203
Rear View Camera.....	208

## Cruise Control

Principle of Operation.....	212
Using Cruise Control.....	212
Using Adaptive Cruise Control.....	213

## Driving Aids

Driver Alert.....	221
Lane Keeping System.....	222
Blind Spot Information System.....	227
Steering.....	232
Collision Warning System.....	233
Drive Control.....	236

## Load Carrying

Load Limit.....	238
-----------------	-----

## Towing

Towing a Trailer.....	247
Transporting the Vehicle.....	247
Towing the Vehicle on Four Wheels.....	248

## Driving Hints

Breaking-In.....	249
------------------	-----

# Table of Contents

---

Economical Driving.....	249
Driving Through Water.....	249
Floor Mats.....	250

## Roadside Emergencies

Roadside Assistance.....	252
Hazard Warning Flashers.....	253
Fuel Shutoff.....	253
Jump Starting the Vehicle.....	254
Collision, Damage or Fire Event.....	257
Post-Crash Alert System.....	259

## Customer Assistance

Getting the Services You Need.....	260
In California (U.S. Only).....	261
The Better Business Bureau (BBB) Auto Line Program (U.S. Only).....	262
Utilizing the Mediation/Arbitration Program (Canada Only).....	263
Getting Assistance Outside the U.S. and Canada.....	263
Ordering Additional Owner's Literature.....	265
Reporting Safety Defects (U.S. Only).....	265

Reporting Safety Defects (Canada Only).....	266
--	-----

## Fuses

Fuse Specification Chart.....	267
Changing a Fuse.....	284

## Maintenance

General Information.....	285
Opening and Closing the Hood.....	286
Under Hood Overview.....	286
Engine Oil Dipstick.....	288
Engine Oil Check.....	288
Engine Coolant Check.....	289
Automatic Transmission Fluid Check.....	294
Brake Fluid Check.....	294
Power Steering Fluid Check.....	294
Washer Fluid Check.....	294
Fuel Filter.....	295
Changing the 12V Battery.....	295
Checking the Wiper Blades.....	297
Changing the Wiper Blades.....	297
Adjusting the Headlamps.....	297

Changing a Bulb.....	299
Bulb Specification Chart.....	299
Changing the Engine Air Filter.....	301

## Vehicle Care

General Information.....	302
Cleaning Products.....	302
Cleaning the Exterior.....	302
Waxing.....	303
Cleaning the Engine.....	304
Cleaning the Windows and Wiper Blades.....	304
Cleaning the Interior.....	305
Cleaning the Instrument Panel and Instrument Cluster Lens.....	306
Cleaning Leather Seats.....	307
Repairing Minor Paint Damage.....	308
Cleaning the Alloy Wheels.....	308
Vehicle Storage.....	308

## Wheels and Tires

Temporary Mobility Kit.....	311
Tire Care.....	324

# Table of Contents

---

Using Snow Chains.....	338
Tire Pressure Monitoring System.....	339
Technical Specifications.....	344

## Capacities and Specifications

Engine Specifications.....	346
Motorcraft Parts.....	347
Vehicle Identification Number.....	348
Vehicle Certification Label.....	348
Transmission Code Designation.....	349
Capacities and Specifications - 2.0L Hybrid.....	350

## Audio System

General Information.....	355
Audio Unit - Vehicles With: Premium AM/ FM/CD.....	356
Media Hub.....	358

## MyLincoln Touch™

General Information.....	359
Settings.....	372
Entertainment.....	385

Phone.....	407
Electric Vehicle Information.....	414
Information.....	419
Climate.....	430
Navigation.....	435

## Accessories

Accessories.....	445
------------------	-----

## Appendices

End User License Agreement.....	447
---------------------------------	-----

## Extended Service Plan (ESP)

Extended Service Plan (ESP).....	465
----------------------------------	-----

## Scheduled Maintenance

General Maintenance Information.....	468
Normal Scheduled Maintenance.....	473
Special Operating Conditions Scheduled Maintenance.....	475
Scheduled Maintenance Record.....	477



# Introduction

## ABOUT THIS MANUAL

Thank you for choosing Lincoln. We recommend that you take some time to get to know your vehicle by reading this manual. The more that you know about it, the greater the safety and pleasure you will get from driving it.

### WARNING



Driving while distracted can result in loss of vehicle control, crash and injury. We strongly recommend that you use extreme caution when using any device that may take your focus off the road. Your primary responsibility is the safe operation of your vehicle. We recommend against the use of any handheld device while driving and encourage the use of voice-operated systems when possible. Make sure you are aware of all applicable local laws that may affect the use of electronic devices while driving.

**Note:** *This manual describes product features and options available throughout the range of available models, sometimes even before they are generally available. It may describe options not fitted to your vehicle.*

**Note:** *Some of the illustrations in this manual may be used for different models, so may appear different to you on your vehicle. However, the essential information in the illustrations is always correct.*

**Note:** *Always use and operate your vehicle in line with all applicable laws and regulations.*

**Note:** *Pass on this manual when selling your vehicle. It is an integral part of the vehicle.*

This manual may qualify the location of a component as left-hand side or right-hand side. The side is determined when facing forward in the seat.



E154903

- A Right-hand side
- B Left-hand side

## Protecting the Environment

You must play your part in protecting the environment. Correct vehicle usage and the authorized disposal of waste, cleaning and lubrication materials are significant steps toward this aim.

## SYMBOLS GLOSSARY

These are some of the symbols you may see on your vehicle.

# Introduction



Safety alert



See Owner's Manual



Air conditioning system



Anti-lock braking system



Avoid smoking, flames or sparks



Battery



Battery acid



Brake fluid - non petroleum based



Brake system



Cabin air filter



Check fuel cap



Child safety door lock or unlock



Child seat lower anchor



Child seat tether anchor



Cruise control



Do not open when hot



Engine air filter



Engine coolant



Engine coolant temperature



Engine oil



Explosive gas



Fan warning



Fasten safety belt



Front airbag



Front fog lamps



Fuel pump reset



Fuse compartment

# Introduction



Hazard warning flashers



Heated rear window



Heated windshield



Interior luggage compartment release



Jack



Keep out of reach of children



Lighting control



Low tire pressure warning



Maintain correct fluid level



Note operating instructions



Panic alarm



Parking aid



Parking brake



Power steering fluid



Power windows front/rear



Power window lockout



Service engine soon



Side airbag



Shield the eyes



Stability control



Windshield wash and wipe

## DATA RECORDING

### Service Data Recording

Service data recorders in your vehicle are capable of collecting and storing diagnostic information about your vehicle. This potentially includes information about the performance or status of various systems and modules in the vehicle, such as engine, throttle, steering or brake systems. In order to properly diagnose and service your vehicle, Ford Motor Company, Ford of Canada, and service and repair facilities may access or share among them vehicle diagnostic information received through a direct connection to your vehicle when diagnosing or servicing your vehicle.

# Introduction

---

Additionally, when your vehicle is in for service or repair, Ford Motor Company, Ford of Canada, and service and repair facilities may access or share among them data for vehicle improvement purposes. For U.S. only (if equipped), if you choose to use the SYNC Vehicle Health Report, you consent that certain diagnostic information may also be accessed electronically by Ford Motor Company and Ford authorized service facilities, and that the diagnostic information may be used for any purpose. See **MyLincoln Touch™** (page 359).

## Event Data Recording

**This vehicle is equipped with an event data recorder. The main purpose of an event data recorder is to record, in certain crash or near crash-like situations, such as an airbag deployment or hitting a road obstacle; this data will assist in understanding how a vehicle's systems performed. The event data recorder is designed to record data related to vehicle dynamics and safety systems for a short period of time, typically 30 seconds or less.**

**The event data recorder in this vehicle is designed to record such data as:**

- **How various systems in your vehicle were operating;**
- **Whether or not the driver and passenger safety belts were buckled/fastened;**
- **How far (if at all) the driver was depressing the accelerator and/or the brake pedal; and**
- **How fast the vehicle was traveling; and**
- **Where the driver was positioning the steering wheel.**

**This data can help provide a better understanding of the circumstances in which crashes and injuries occur.**

***Note: Event data recorder data is recorded by your vehicle only if a non-trivial crash situation occurs; no data is recorded by the event data recorder under normal driving conditions and no personal data or information (e.g., name, gender, age, and crash location) is recorded (see limitations regarding 911 Assist and Traffic, directions and Information privacy below). However, parties, such as law enforcement, could combine the event data recorder data with the type of personally identifying data routinely acquired during a crash investigation.***

**To read data recorded by an event data recorder, special equipment is required, and access to the vehicle or the event data recorder is needed. In addition to the vehicle manufacturer, other parties, such as law enforcement, that have such special equipment, can read the information if they have access to the vehicle or the event data recorder. Ford Motor Company and Ford of Canada do not access event data recorder information without obtaining consent, unless pursuant to court order or**

# Introduction

---

where required by law enforcement, other government authorities or other third parties acting with lawful authority. Other parties may seek to access the information independently of Ford Motor Company and Ford of Canada.

**Note:** *Including to the extent that any law pertaining to Event Data Recorders applies to SYNC or its features, please note the following: Once 911 Assist (if equipped) is enabled (set ON), 911 Assist may, through any paired and connected cell phone, disclose to emergency services that the vehicle has been in a crash involving the deployment of an airbag or, in certain vehicles, the activation of the fuel pump shut-off. Certain versions or updates to 911 Assist may also be capable of being used to electronically or verbally provide to 911 operators the vehicle location (such as latitude and longitude), and/or other details about the vehicle or crash or personal information about the occupants to assist 911 operators to provide the most appropriate emergency services. If you do not want to disclose this information, do not activate the 911 Assist feature. See MyLincoln Touch™ (page 359).*

Additionally, when you connect to Traffic, Directions and Information (if equipped, U.S. only), the service uses GPS technology and advanced vehicle sensors to collect the vehicle's current location, travel direction, and speed ("vehicle travel information"), only to help provide you with the directions, traffic reports, or business searches that you request. If you do not want Ford or its vendors to receive this information, do not activate the service. For more information, see Traffic, Directions and Information, Terms and Conditions. See MyLincoln Touch™ (page 359).

## CALIFORNIA PROPOSITION 65

### WARNING



Some constituents of engine exhaust, certain vehicle components, certain fluids contained in vehicles and certain products of component wear contain or emit chemicals known to the State of California to cause cancer and birth defects or other reproductive harm.

---

# Introduction

---

## PERCHLORATE

Certain components in your vehicle such as airbag modules, safety belt pretensioners and remote control batteries may contain perchlorate material. Special handling may apply for service or vehicle end of life disposal. For more information visit:

Web Address
<a href="http://www.dtsc.ca.gov/hazardouswaste/perchlorate">www.dtsc.ca.gov/hazardouswaste/perchlorate</a>

## LINCOLN AUTOMOTIVE FINANCIAL SERVICES

Lincoln Automotive Financial Services offers a full range of financing and lease plans to help you acquire your vehicle. If you have financed or leased your vehicle through Lincoln Automotive Financial Services, thank you for your business.

For your convenience we offer a number of ways to contact us, as well as help manage your account.

Phone: 1-888-498-8801

For more information regarding Lincoln Automotive Financial Services, as well as access Account Manager, please go to [www.LincolnAFS.com](http://www.LincolnAFS.com).

## REPLACEMENT PARTS RECOMMENDATION

Your vehicle has been built to the highest standards using quality parts. We recommend that you demand the use of genuine Ford and Motorcraft parts whenever your vehicle requires scheduled maintenance or repair. You can clearly identify genuine Ford and Motorcraft parts by looking for the Ford, FoMoCo or Motorcraft branding on the parts or their packaging.

## Scheduled Maintenance and Mechanical Repairs

One of the best ways for you to make sure that your vehicle provides years of service is to have it maintained in line with our recommendations using parts that conform to the specifications detailed in this Owner's Manual. Genuine Ford and Motorcraft parts meet or exceed these specifications.

## Collision Repairs

We hope that you never experience a collision, but accidents do happen. Genuine Ford replacement collision parts meet our stringent requirements for fit, finish, structural integrity, corrosion protection and dent resistance. During vehicle development we validate these parts deliver the intended level of protection as a whole system. A great way to know for sure you are getting this level of protection is to use genuine Ford replacement collision parts.

# Introduction

---

## Warranty on Replacement Parts

Genuine Ford and Motorcraft replacement parts are the only replacement parts that benefit from a Ford Warranty. Damage caused to your vehicle as a result of the failure of non-Ford parts may not be covered by the Ford Warranty. For additional information, refer to the terms and conditions of the Ford Warranty.

## SPECIAL NOTICES

### New Vehicle Limited Warranty

For a detailed description of what is covered and what is not covered by your vehicle's New Vehicle Limited Warranty, refer to the Warranty Manual that is provided to you along with your Owner's Manual.

### Special Instructions

For your added safety, your vehicle is fitted with sophisticated electronic controls.

## WARNINGS



Failure to follow the specific warnings and instructions could result in personal injury. See **Supplementary Restraints System** (page 43).



Front seat mounted rear-facing child or infant seats should **NEVER** be placed in front of an active passenger airbag.

## MOBILE COMMUNICATIONS EQUIPMENT

Using mobile communications equipment is becoming increasingly important in the conduct of business and personal affairs. However, you must not compromise your own or others' safety when using such equipment. Mobile communications can enhance personal safety and security when appropriately used, particularly in emergency situations. Safety must be paramount when

using mobile communications equipment to avoid negating these benefits. Mobile communication equipment includes, but is not limited to, cellular phones, pagers, portable email devices, text messaging devices and portable two-way radios.

## WARNING



Driving while distracted can result in loss of vehicle control, crash and injury. We strongly recommend that you use extreme caution when using any device that may take your focus off the road. Your primary responsibility is the safe operation of your vehicle. We recommend against the use of any hand-held device while driving and encourage the use of voice-operated systems when possible. Make sure you are aware of all applicable local laws that may affect the use of electronic devices while driving.

---

# Introduction

---

## EXPORT UNIQUE OPTIONS

For your particular global region, your vehicle may be equipped with features and options that are different from the features and options that are described in this Owner's Manual. A market unique supplement may be supplied that complements this book. By referring to the market unique supplement, if provided, you can properly identify those features, recommendations and specifications that are unique to your vehicle. This Owner's Manual is written primarily for the U.S. and Canadian Markets. Features or equipment listed as standard may be different on units built for Export. **Refer to this Owner's Manual for all other required information and warnings.**

# Child Safety

---

## GENERAL INFORMATION

See the following sections for directions on how to properly use safety restraints for children.

### WARNINGS



Always make sure your child is secured properly in a device that is appropriate for their height, age and weight. Child safety restraints must be bought separately from your vehicle. Failure to follow these instructions and guidelines may result in an increased risk of serious injury or death to your child.

### WARNINGS



All children are shaped differently. The recommendations for safety restraints are based on probable child height, age and weight thresholds from National Highway Traffic Safety Administration and other safety organizations, or are the minimum requirements of law. Ford recommends checking with a NHTSA Certified Child Passenger Safety Technician (CPST) and consult your pediatrician to make sure your child seat is appropriate for your child, and is compatible with and properly installed in your vehicle. To locate a child seat fitting station and CPST, contact the NHTSA toll

### WARNINGS

free at 1-888-327-4236 or go to <http://www.nhtsa.dot.gov>. In Canada, check with your local St. John Ambulance office for referral to a CPST or for further information, contact your provincial ministry of transportation, locate your local St. John Ambulance office by searching for St. John Ambulance on the internet, or Transport Canada at 1-800-333-0371 (<http://www.tc.gc.ca>). Failure to properly restrain children in safety seats made especially for their height, age, and weight may result in an increased risk of serious injury or death to your child.

---

# Child Safety

## Recommendations for Safety Restraints for Children

Child	Child size, height, weight, or age	Recommended restraint type
Infants or toddlers	Children weighing 40 lb (18 kg) or less (generally age four or younger).	Use a child safety seat (sometimes called an infant carrier, convertible seat, or toddler seat).
Small children	Children who have outgrown or no longer properly fit in a child safety seat (generally children who are less than 4 ft. 9 in. (1.45 m) tall, are greater than age four and less than age 12, and between 40 lb (18 kg) and 80 lb (36 kg) and upward to 100 lb (45 kg) if recommended by your child restraint manufacturer).	Use a belt-positioning booster seat.
Larger children	Children who have outgrown or no longer properly fit in a belt-positioning booster seat (generally children who are at least 4 ft. 9 in. (1.45 m) tall or greater than 80 lb (36 kg) or 100 lb (45 kg) if recommended by child restraint manufacturer).	Use a vehicle safety belt having the lap belt snug and low across the hips, shoulder belt centered across the shoulder and chest, and seat back upright.

# Child Safety

- You are required by law to properly use safety seats for infants and toddlers in the United States and Canada.
- Many states and provinces require that small children use approved booster seats until they reach age eight, a height of 4 feet 9 inches (1.45 meters) tall, or 80 pounds (36 kilograms). Check your local and state or provincial laws for specific requirements about the safety of children in your vehicle.
- When possible, always properly restrain children 12 years of age and under in a rear seating position of your vehicle. Accident statistics suggest that children are safer when properly restrained in the rear seating positions than in a front seating position. See **Front Passenger Sensing System** (page 45).

## INSTALLING CHILD SEATS

### Child Seats



E142594

Use a child safety seat (sometimes called an infant carrier, convertible seat, or toddler seat) for infants, toddlers, or children weighing 40 pounds (18 kilograms) or less (generally age four or younger).

## Using Lap and Shoulder Belts

### WARNINGS

- ⚠️ Airbags can kill or injure a child in a child seat. Never place a rear-facing child seat in front of an active airbag. If you must use a forward-facing child seat in the front seat, move the seat upon which the child seat is installed all the way back.
- ⚠️ Airbags can kill or injure a child in a child seat. Children 12 and under should be properly restrained in the rear seat whenever possible.
- ⚠️ Depending on where you secure a child restraint, and depending on the child restraint design, you may block access to certain safety belt buckle assemblies and LATCH lower anchors, rendering those features potentially unusable. To avoid risk of injury, occupants should only use seating positions where they are able to be properly restrained.

# Child Safety

When installing a child safety seat with combination lap and shoulder belts:

- Use the correct safety belt buckle for that seating position.
- Insert the belt tongue into the proper buckle until you hear a snap and feel it latch. Make sure the tongue is securely fastened in the buckle.
- Keep the buckle release button pointing up and away from the safety seat, with the tongue between the child seat and the release button, to prevent accidental unbuckling.
- Place the vehicle seat upon which the child seat will be installed in the upright position.
- Put the safety belt in the automatic locking mode. See Step 5. This vehicle does not require the use of a locking clip.

Perform the following steps when installing the child seat with combination lap and shoulder belts:

**Note:** Although the child seat illustrated is a forward facing child seat, the steps are the same for installing a rear facing child seat.

## Standard safety belts



E142528

1. Position the child safety seat in a seat with a combination lap and shoulder belt.



E142529

2. After positioning the child safety seat in the proper seating position, pull down on the shoulder belt and then grasp the shoulder belt and lap belt together behind the belt tongue.



E142530

3. While holding the shoulder and lap belt portions together, route the tongue through the child seat according to the child seat manufacturer's instructions. Be sure the belt webbing is not twisted.

# Child Safety

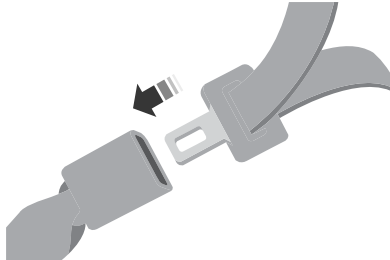

E142531

4. Insert the belt tongue into the proper buckle (the buckle closest to the direction the tongue is coming from) for that seating position until you hear a snap and feel the latch engage. Make sure the tongue is latched securely by pulling on it.



E142875

5. To put the retractor in the automatic locking mode, grasp the shoulder portion of the belt and pull downward until all of the belt is pulled out.

**Note:** *The automatic locking mode is available on the front passenger and rear seats.*

6. Allow the belt to retract to remove slack. The belt will click as it retracts to indicate it is in the automatic locking mode.

7. Try to pull the belt out of the retractor to make sure the retractor is in the automatic locking mode (you should not be able to pull more belt out). If the retractor is not locked, unbuckle the belt and repeat Steps 5 and 6.



E142533

8. Remove remaining slack from the belt. Force the seat down with extra weight, for example, by pressing down or kneeling on the child restraint while pulling up on the shoulder belt in order to force slack from the belt. This is necessary to remove the remaining slack that will exist once the extra weight of

# Child Safety

the child is added to the child restraint. It also helps to achieve the proper snugness of the child seat to your vehicle. Sometimes, a slight lean toward the buckle will provide extra help to remove remaining slack from the belt.

9. Attach the tether strap (if the child seat is equipped).

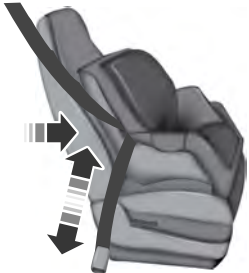

E142534

10. Before placing the child in the seat, forcibly move the seat forward and back to make sure the seat is securely held in place. To check this, grab the seat at the belt path and attempt to move it side to side and forward and back. There should be no more than 1 inch (2.5 centimeters) of movement for proper installation.

Ford recommends checking with a NHTSA Certified Child Passenger Safety Technician to make certain the child restraint is properly installed. In Canada, check with your local St. John Ambulance office for referral to a Certified Passenger Seat Technician.

## Inflatable safety belts



E142528

1. Position the child safety seat in a seat with a combination lap and shoulder belt.



E146522

# Child Safety

2. After positioning the child safety seat in the proper seating position, grasp the shoulder belt and lap belt together behind the belt tongue.



E142530

3. While holding the shoulder and lap belt portions together, route the tongue through the child seat according to the child seat manufacturer's instructions. Be sure the belt webbing is not twisted.

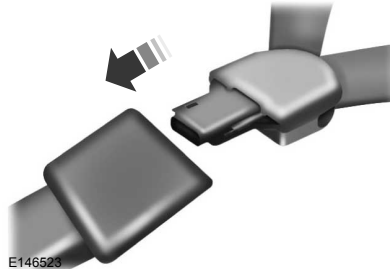

E146523

4. Insert the belt tongue into the proper buckle (the buckle closest to the direction the tongue is coming from) for that seating position until you hear a snap and feel the latch engage. Make sure the tongue is latched securely by pulling on it.

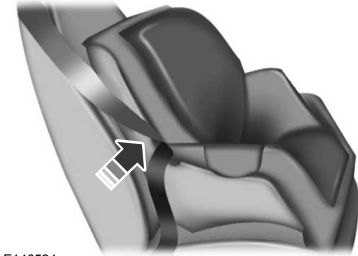

E146524

5. To put the retractor in the automatic locking mode, grasp the lap portion of the inflatable safety belt and pull upward until all of the belt is pulled out.

**Note:** *The automatic locking mode is available on the front passenger and rear seats.*

**Note:** *Unlike the standard safety belt, the inflatable safety belt's unique lap portion locks the child seat for installation. The ability for the shoulder portion of the belt to move freely is normal, even after the lap belt has been put into the automatic locking mode.*

# Child Safety

**Note:** The lock-off device on some child restraints may not accommodate the shoulder portion of the inflatable safety belt. Follow all instructions provided by the manufacturer of the child restraint regarding the necessary and proper use of the lock-off device. In some instances, these devices have been provided only for use in vehicles with safety belt systems that would otherwise require a locking clip.

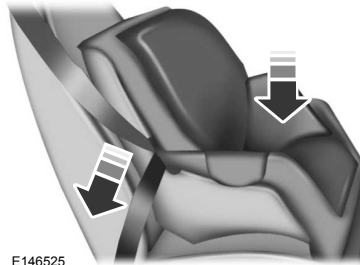

E146525

6. Allow the belt to retract to remove slack. The belt will click as it retracts to indicate it is in the automatic locking mode.
7. Try to pull the belt out of the retractor to make sure the retractor is in the automatic locking mode (you should not be able to pull more belt out). If the retractor is not locked, unbuckle the belt and repeat Steps 5 and 6.

8. Remove remaining slack from the belt. Force the seat down with extra weight, for example, by pressing down or kneeling on the child restraint while pulling down on the lap belt in order to force slack from the belt. This is necessary to remove the remaining slack that will exist once the extra weight of the child is added to the child restraint. It also helps to achieve the proper snugness of the child seat to your vehicle. Sometimes, a slight lean toward the buckle will additionally help to remove remaining slack from the belt.
9. Attach the tether strap (if the child seat is equipped).



E142534

10. Before placing the child in the seat, forcibly move the seat forward and back to make sure the seat is securely held in place. To check this, grab the seat at the belt path and attempt to move it side to side and forward and back. There should be no more than 1 inch (2.5 centimeters) of movement for proper installation.

Ford recommends checking with a NHTSA Certified Child Passenger Safety Technician to make certain the child restraint is properly installed. In Canada, check with your local St. John Ambulance office for referral to a Certified Passenger Seat Technician.

# Child Safety

## Using Lower Anchors and Tethers for Children (LATCH)

### WARNINGS

 Never attach two child safety seats to the same anchor. In a collision, one anchor may not be strong enough to hold two child safety seat attachments and may break, causing serious injury or death.

 Depending on where you secure a child restraint, and depending on the child restraint design, you may block access to certain safety belt buckle assemblies or LATCH lower anchors, rendering those features potentially unusable. To avoid risk of injury, occupants should only use seating positions where they are able to be properly restrained.

The LATCH system is composed of three vehicle anchor points: two lower anchors located where seat back and seat cushion meet (called the seat bight) and one top tether anchor located behind that seating position.

LATCH compatible child safety seats have two rigid or webbing mounted attachments that connect to the two lower anchors at the LATCH equipped seating positions in your vehicle. This type of attachment method eliminates the need to use safety belts to attach the child seat, however the safety belt can still be used to attach the child seat. For forward-facing child seats, the top tether strap must also be attached to the proper top tether anchor, if a top tether strap has been provided with your child seat.

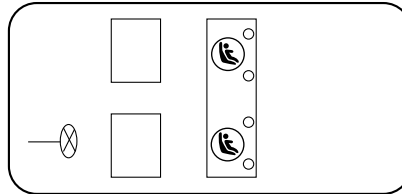

E142535

Your vehicle has LATCH lower anchors for child seat installation at the seating positions marked with the child seat symbol.



E144054

The LATCH anchors are located at the rear section of the rear seat between the cushion and seat back below the symbols as shown. Follow the child seat manufacturer's instructions to properly install a child seat with LATCH attachments. Follow the instructions on attaching child safety seats with tether straps.

Attach LATCH lower attachments of the child seat only to the anchors shown.

# Child Safety

## Use of Inboard Lower Anchors from the Outboard Seating Positions (Center Seating Use)

### WARNING



The standardized spacing for LATCH lower anchors is 11 inches (28 centimeters) center to center. Do not use LATCH lower anchors for the center seating position unless the child seat manufacturer's instructions permit and specify using anchors spaced at least as far apart as those in this vehicle.

The lower anchors at the center of the second row rear seat are spaced 18 inches (46 centimeters) apart. A child seat with rigid LATCH attachments cannot be installed at the center seating position. LATCH compatible child seats (with attachments on belt webbing) can only be used at this seating position provided that the child seat manufacturer's instructions permit use with the anchor spacing stated. Do not attach a child seat to any lower anchor if an adjacent child seat is attached to that anchor.

Each time you use the safety seat, check that the seat is properly attached to the lower anchors and tether anchor, if applicable. Tug the child seat from side to side and forward and back where it is secured to your vehicle. The seat should move less than one inch when you do this for a proper installation.

If the safety seat is not anchored properly, the risk of a child being injured in a crash greatly increases.

### Combining Safety Belt and LATCH Lower Anchors for Attaching Child Safety Seats

When used in combination, either the safety belt or the LATCH lower anchors may be attached first, provided a proper installation is achieved. Attach the tether strap afterward, if included with the child seat.

## Using Tether Straps



Many forward-facing child safety seats include a tether strap which extends from the back of the child safety seat and hooks to an anchoring point called the top tether anchor. Tether straps are available as an accessory for many older safety seats.

Contact the manufacturer of your child seat for information about ordering a tether strap, or to obtain a longer tether strap if the tether strap on your safety seat does not reach the appropriate top tether anchor in your vehicle.

Once the child safety seat has been installed using either the safety belt, the lower anchors of the LATCH system, or both, you can attach the top tether strap.

The tether strap anchors in your vehicle are in the following positions (shown from top view):

# Child Safety

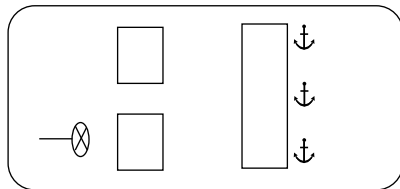

E142537

Perform the following steps to install a child safety seat with tether anchors:

**Note:** *If you install a child seat with rigid LATCH attachments, do not tighten the tether strap enough to lift the child seat off your vehicle seat cushion when the child is seated in it. Keep the tether strap just snug without lifting the front of the child seat. Keeping the child seat just touching your vehicle seat gives the best protection in a severe crash.*

1. Route the child safety seat tether strap over the back of the seat. For outboard seating positions, route the tether strap under the head restraint and between the head restraint posts. For the center seating positions, route the tether strap over the top of the head restraint. If needed, the head restraints can also be removed.



E144274

2. Locate the correct anchor for the selected seating position, then open the tether anchor cover.



E144275

3. Clip the tether strap to the anchor as shown.
4. Tighten the child safety seat tether strap according to the manufacturer's instructions.

If your child restraint system is equipped with a tether strap, and the child restraint manufacturer recommends its use, Ford also recommends its use.

# Child Safety

## BOOSTER SEATS

### WARNING

 Never place, or allow a child to place, the shoulder belt under a child's arm or behind the back because it reduces the protection for the upper part of the body and may increase the risk of injury or death in a collision.

**Note:** *Some booster seat safety belt guides may not accommodate the shoulder portion of the inflatable safety belt.*

Use a belt-positioning booster seat for children who have outgrown or no longer properly fit in a child safety seat (generally children who are less than 4 feet 9 inches (1.45 meters) tall, are greater than age four (4) and less than age twelve (12), and between 40 pounds (18 kilograms) and 80 pounds (36 kilograms) and upward to 100

pounds (45 kilograms) if recommended by your child restraint manufacturer). Many state and provincial laws require that children use approved booster seats until they reach age eight, a height of 4 feet 9 inches (1.45 meters) tall, or 80 pounds (36 kilograms).

Booster seats should be used until you can answer YES to ALL of these questions when seated without a booster seat:

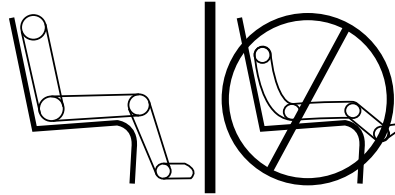

E142595

- Can the child sit all the way back against their vehicle seat back with knees bent comfortably at the edge of the seat cushion?
- Can the child sit without slouching?

- Does the lap belt rest low across the hips?
- Is the shoulder belt centered on the shoulder and chest?
- Can the child stay seated like this for the whole trip?

Always use booster seats in conjunction with your vehicle lap and shoulder belt.

### Types of Booster Seats



E68924

- Backless booster seats

# Child Safety

If your backless booster seat has a removable shield, remove the shield. If a vehicle seating position has a low seat back or no head restraint, a backless booster seat may place your child's head (as measured at the tops of the ears) above the top of the seat. In this case, move the backless booster to another seating position with a higher seat back or head restraint and lap and shoulder belts, or consider using a high back booster seat.



E70710

- High back booster seats

If, with a backless booster seat, you cannot find a seating position that adequately supports your child's head, a high back booster seat would be a better choice.

Children and booster seats vary in size and shape. Choose a booster that keeps the lap belt low and snug across the hips, never up across the stomach, and lets you adjust the shoulder belt to cross the chest and rest snugly near the center of the shoulder. The following drawings compare the ideal fit (center) to a shoulder belt uncomfortably close to the neck and a shoulder belt that could slip off the shoulder. The drawings also show how the lap belt should be low and snug across the child's hips.



E142596

# Child Safety



If the booster seat slides on the vehicle seat upon which it is being used, placing a rubberized mesh sold as shelf or carpet liner under the booster seat may improve this condition. Do not introduce any item thicker than this under the booster seat. Check with the booster seat manufacturer's instructions.

## CHILD SEAT POSITIONING

### WARNINGS



Airbags can kill or injure a child in a child seat. Never place a rear-facing child seat in front of an active airbag. If you must use a forward-facing child seat in the front seat, move the vehicle seat upon which the child seat is installed all the way back. When possible, all children age 12 and under should be properly restrained in a rear seating position. If all children cannot be seated and restrained properly in a rear seating position, properly restrain the largest child in the front seat.

### WARNINGS





Always carefully follow the instructions and warnings provided by the manufacturer of any child restraint to determine if the restraint device is appropriate for your child's size, height, weight, or age. Follow the child restraint manufacturer's instructions and warnings provided for installation and use in conjunction with the instructions and warnings provided by your vehicle manufacturer. A safety seat that is improperly installed or utilized, is inappropriate for your child's height, age, or weight or does not properly fit the child may increase the risk of serious injury or death.

# Child Safety

---

## WARNINGS

 Never let a passenger hold a child on his or her lap while your vehicle is moving. The passenger cannot protect the child from injury in a crash, which may result in serious injury or death.

 Never use pillows, books, or towels to boost a child. They can slide around and increase the likelihood of injury or death in a crash.

## WARNINGS

 Always restrain an unoccupied child seat or booster seat. These objects may become projectiles in a crash or sudden stop, which may increase the risk of serious injury.

## WARNINGS

 Never place, or allow a child to place, the shoulder belt under a child's arm or behind the back because it reduces the protection for the upper part of the body and may increase the risk of injury or death in a crash.

 To avoid risk of injury, do not leave children or pets unattended in your vehicle.

---

# Child Safety

## Recommendations for attaching child safety restraints for children

Restraint Type	Combined weight of child and child seat	Use any attachment method as indicated below by X				
		LATCH (lower anchors and top tether anchor)	LATCH (lower anchors only)	Safety belt and top tether anchor	Safety belt and LATCH (lower anchors and top tether anchor)	Safety belt only
Rear facing child seat	Up to 65 lb (29 kg)		X			X
Rear facing child seat	Over 65 lb (29 kg)					X
Forward facing child seat	Up to 65 lb (29 kg)	X		X	X	
Forward facing child seat	Over 65 lb (29 kg)			X	X	

**Note:** *The child seat must rest tightly against the vehicle seat upon which it is installed. It may be necessary to lift or remove the head restraint. See **Seats** (page 144).*

## CHILD SAFETY LOCKS

When these locks are set, the rear doors cannot be opened from the inside.

# Child Safety

---



E112197

The childproof locks are located on the rear edge of each rear door and must be set separately for each door.

## Left-Hand Side

Turn counterclockwise to lock and clockwise to unlock.

## Right-Hand Side

Turn clockwise to lock and counterclockwise to unlock.

# Safety Belts

## PRINCIPLE OF OPERATION

### WARNINGS

 Always drive and ride with your seat back upright and the lap belt snug and low across the hips.

 To reduce the risk of injury, make sure children sit where they can be properly restrained.

 Never let a passenger hold a child on his or her lap while your vehicle is moving. The passenger cannot protect the child from injury in a crash.

 All occupants of your vehicle, including the driver, should always properly wear their safety belts, even when an airbag supplemental restraint system is provided. Failure to properly wear your safety belt could seriously increase the risk of injury or death.

### WARNINGS

 It is extremely dangerous to ride in a cargo area, inside or outside of a vehicle. In a crash, people riding in these areas are more likely to be seriously injured or killed. Do not allow people to ride in any area of your vehicle that is not equipped with seats and safety belts. Be sure everyone in your vehicle is in a seat and using a safety belt properly.

 In a rollover crash, an unbelted person is significantly more likely to die than a person wearing a safety belt.

 Each seating position in your vehicle has a specific safety belt assembly which is made up of one buckle and one tongue that are designed to be used as a pair. 1) Use the shoulder belt on the outside shoulder only. Never wear the shoulder belt under the arm. 2) Never swing the safety belt around your neck over the inside shoulder. 3) Never use a single belt for more than one person.

### WARNINGS

 When possible, all children 12 years old and under should be properly restrained in a rear seating position. Failure to follow this could seriously increase the risk of injury or death.

 Safety belts and seats can become hot in a vehicle that has been closed up in sunny weather; they could burn a small child. Check seat covers and buckles before you place a child anywhere near them.

 Front and rear seat occupants, including pregnant women, should wear safety belts for optimum protection in an accident.

All seating positions in your vehicle have lap and shoulder safety belts. All occupants of the vehicle should always properly wear their safety belts, even when an airbag supplemental restraint system is provided.

The safety belt system consists of:

- lap and shoulder safety belts.
- shoulder safety belt with automatic locking mode, (except driver safety belt).

# Safety Belts

- height adjuster at the front outboard seating positions.
- safety belt pretensioner at the front outboard seating positions.
- belt tension sensor at the front outboard passenger seating position.



- Safety belt warning light and chime.



- Crash sensors and monitoring system with readiness indicator.

The safety belt pretensioners at the front seating positions are designed to tighten the safety belts when activated. In frontal and near-frontal crashes, the safety belt pretensioners may be activated alone or, if the crash is of sufficient severity, together with the front airbags. The pretensioners may also activate when a side curtain airbag is deployed.

## FASTENING THE SAFETY BELTS

### Standard belts shown, inflatable belts similar

The front outboard and rear safety restraints in the vehicle are combination lap and shoulder belts.



E142587

1. Insert the belt tongue into the proper buckle (the buckle closest to the direction the tongue is coming from) until you hear a snap and feel it latch. Make sure you securely fasten the tongue in the buckle.

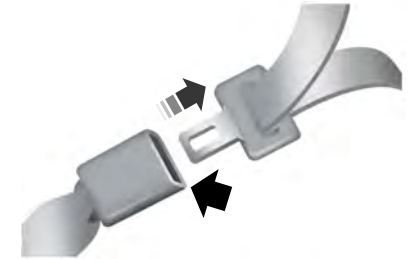

E142588

2. To unfasten, press the release button and remove the tongue from the buckle.

## Using Safety Belts During Pregnancy

### WARNING



Always ride and drive with your seatback upright and the safety belt properly fastened. The lap portion of the safety belt should fit snug and be positioned low across the hips. The shoulder portion of the safety belt should be positioned across the chest. Pregnant women should also follow this practice. See the following figure.

# Safety Belts

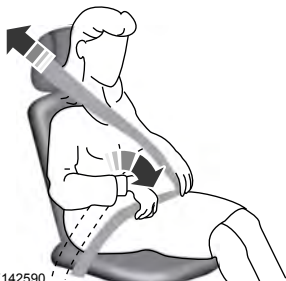

Pregnant women should always wear their safety belt. The lap belt portion of a combination lap and shoulder belt should be positioned low across the hips below the belly and worn as tight as comfort will allow. The shoulder belt should be positioned to cross the middle of the shoulder and the center of the chest.

## Safety Belt Locking Modes

### WARNINGS



After any vehicle crash, the safety belt system at all passenger seating positions must be checked by an authorized dealer to verify that the automatic locking retractor feature for child seats is still functioning properly. In addition, all safety belts should be checked for proper function.



Belt and retractor assembly must be replaced if the safety belt assembly automatic locking retractor feature or any other safety belt function is not operating properly when checked by an authorized dealer. Failure to replace the belt and retractor assembly could increase the risk of injury in crashes.

All safety restraints in the vehicle are combination lap and shoulder belts. The driver safety belt has the vehicle sensitive locking mode. The front outboard passenger and rear seat safety belts have both the vehicle sensitive locking mode and the automatic locking mode.

## Vehicle Sensitive Mode

This is the normal retractor mode, which allows free shoulder belt length adjustment to your movements and locking in response to vehicle movement. For example, if the driver brakes suddenly or turns a corner sharply, or the vehicle receives an impact of about 5 mph (8 km/h) or more, the combination safety belts will lock to help reduce forward movement of the driver and passengers.

In addition, the retractor is designed to lock if the webbing is pulled out too quickly. If this occurs, let the belt retract slightly and pull webbing out again in a slow and controlled manner.

## Automatic Locking Mode

In this mode, the shoulder belt is automatically pre-locked. The belt will still retract to remove any slack in the shoulder belt. The automatic locking mode is not available on the driver safety belt.

# Safety Belts

## When to Use the Automatic Locking Mode

This mode should be used any time a child safety seat, except a booster, is installed in passenger front or rear seating positions. Children 12 years old and under should be properly restrained in a rear seating position whenever possible. See **Child Safety** (page 15).

## How to Use the Automatic Locking Mode

### Non-inflatable safety belts



E142591

1. Buckle the combination lap and shoulder belt.

2. Grasp the shoulder portion and pull downward until the entire belt is pulled out. As the belt retracts, you will hear a clicking sound. This indicates the safety belt is now in the automatic locking mode.

### Rear outboard inflatable safety belts (second row only—if equipped)



E146363

1. Buckle the combination lap and shoulder belt.
2. Grasp the lap portion of the belt and pull upward until the entire belt is pulled out.

3. Allow the belt to retract. As the belt retracts, you will hear a clicking sound. This indicates the safety belt is now in the automatic locking mode.

## How to Disengage the Automatic Locking Mode

Unbuckle the combination lap and shoulder belt and allow it to retract completely to disengage the automatic locking mode and activate the vehicle sensitive (emergency) locking mode.

### Rear Inflatable Safety Belt (If Equipped)

#### WARNING



Do not attempt to service, repair, or modify the rear inflatable safety belt.

The rear inflatable safety belts are fitted in the shoulder portion of the safety belts of the second-row outboard seating positions.

# Safety Belts

**Note:** *The rear inflatable safety belts are compatible with most infant and child safety car seats and belt positioning booster seats when properly installed. This is because they are designed to fill with a cooled gas at a lower pressure and at a slower rate than traditional airbags. After inflation, the shoulder portion of the safety belt remains cool to the touch.*

The rear inflatable safety belt consists of the following:

- An inflatable bag located in the shoulder safety belt webbing.
- Lap safety belt webbing with automatic locking mode.
- The same warning light, electronic control and diagnostic unit as used for the front safety belts.
- Impact sensors located in various parts of the vehicle.

## How does the rear inflatable safety belt system work?

The rear inflatable safety belts will function like standard restraints in everyday usage.

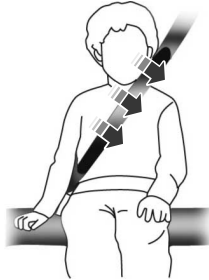

E146364

During a crash of sufficient force, the inflatable belt will inflate from inside the webbing.



E146365

The fully inflated belt's increased diameter more effectively holds the occupant in the appropriate seating position, and spreads crash forces over more area of the body than regular safety belts. This helps reduce pressure on the chest and helps control head and neck motion for passengers.

## WARNING



If the rear inflatable safety belt has deployed, it will not function again. The rear inflatable safety belt system must be replaced by an authorized dealer.

The rear inflatable safety belts are designed to inflate in frontal or near-frontal crashes and some side impact crashes. The fact that the rear inflatable safety belt did not inflate in a crash does not mean that something is wrong with the system. Rather, it means the forces were not of the type sufficient to cause activation.

## Safety Belt Extension Assembly

## WARNINGS



Do not use extensions to change the fit of the shoulder belt across the torso.

# Safety Belts

## WARNINGS



Do not use extensions with an inflatable safety belt.

If the safety belt is too short when fully extended, a safety belt extension assembly can be obtained from an authorized dealer.

Use only extensions manufactured by the same supplier as the safety belt. Manufacturer identification is on a label located either at the end of the webbing or on the retractor behind the trim. Also, use the safety belt extension only if the safety belt is too short for you when fully extended.

## SAFETY BELT HEIGHT ADJUSTMENT

### WARNING



Position the safety belt height adjusters so that the belt rests across the middle of your shoulder. Failure to adjust the safety belt properly could reduce the effectiveness of the safety belt and increase the risk of injury in a crash.

Adjust the height of the shoulder belt so the belt rests across the middle of your shoulder.



E146191

To adjust the shoulder belt height:

1. Press the button and slide the height adjuster up or down.
2. Release the button and pull down on the height adjuster to make sure it is locked in place.

## SAFETY BELT WARNING LAMP AND INDICATOR CHIME



This lamp illuminates and an audible warning will sound if the driver's safety belt has not been fastened when the vehicle's ignition is turned on.

# Safety Belts

## Conditions of operation

If...	Then...
The driver's safety belt is not buckled before the ignition switch is turned to the on position...	The safety belt warning light illuminates 1-2 minutes and the warning chime sounds 4-8 seconds.
The driver's safety belt is buckled while the indicator light is illuminated and the warning chime is sounding...	The safety belt warning light and warning chime turn off.
The driver's safety belt is buckled before the ignition switch is turned to the on position...	The safety belt warning light and indicator chime remain off.

## SAFETY BELT MINDER

### Belt-Minder™

This feature supplements the safety belt warning function by providing additional reminders that intermittently sound a tone and illuminate the safety belt warning light when you are in the driver seat or you have a front seat passenger and a safety belt is unbuckled.

The system uses information from the front passenger sensing system to determine if a front seat passenger is present and therefore potentially in need of a warning. To avoid activating the Belt-Minder feature for objects you place in the front passenger seat, only the front seat passengers receive warnings as determined by the front passenger sensing system.

If the Belt-Minder warnings expire (warnings for about five minutes) for one passenger (driver or front passenger), the other passenger can still cause the Belt-Minder feature to turn on.

# Safety Belts

---

<b>If..</b>	<b>Then...</b>
You and the front seat passenger buckle your safety belts before you switch the ignition on or less than 1-2 minutes elapse after you switch the ignition on...	The Belt-Minder feature will not activate.
You or the front seat passenger do not buckle your safety belts before your vehicle reaches at least 6 mph (9.7 km/h) and 1-2 minutes elapse after you switch the ignition on...	The Belt-Minder feature activates, the safety belt warning light illuminates and a warning tone sounds for 6 seconds every 25 seconds, repeating for about 5 minutes or until you and the front seat passenger buckle your safety belts.
The safety belt for the driver or front passenger is unbuckled for about 1 minute while the vehicle is traveling at least 6 mph (9.7 km/h) and more than 1-2 minutes elapse after you switch the ignition on...	The Belt-Minder feature activates, the safety belt warning light illuminates and a warning tone sounds for 6 seconds every 25 seconds, repeating for about 5 minutes or until you and the front seat passenger buckle your safety belts.

# Safety Belts

## Deactivating and Activating the Belt-Minder Feature

### WARNING



While the system allows you to deactivate it, this system is designed to improve your chances of being safely belted and surviving an accident. We recommend you leave the system activated for yourself and others who may use the vehicle.

**Note:** *The driver and front passenger warnings switch on and off independently. When you perform this procedure for one seating position, do not buckle the other position as this will terminate the process.*

Read Steps 1 - 4 thoroughly before proceeding with the programming procedure.

Before following the procedure, make sure that:

- The parking brake is set.
- The transmission is in park (P) or neutral (N).

- The ignition is off.
  - The driver and front passenger safety belts are unbuckled.
1. Switch the ignition on. Do not start the vehicle.
  2. Wait until the safety belt warning light turns off (about one minute). After Step 2, wait an additional 5 seconds before proceeding with Step 3. Once you start Step 3, you must complete the procedure within 30 seconds.
  3. For the seating position you are switching off, buckle then unbuckle the safety belt three times at a moderate speed, ending in the unbuckled state. After Step 3, the safety belt warning light turns on.
  4. While the safety belt warning light is on, buckle and then unbuckle the safety belt. After Step 4, the safety belt warning light flashes for confirmation.
- This will switch the feature off for that seating position if it is currently on.
  - This will switch the feature on for that seating position if it is currently off.

## CHILD RESTRAINT AND SAFETY BELT MAINTENANCE

Inspect the vehicle safety belts and child safety seat systems periodically to make sure they work properly and are not damaged. Inspect the vehicle and child seat safety belts to make sure there are no nicks, tears or cuts. Replace if necessary. All vehicle safety belt assemblies, including retractors, buckles, front safety belt buckle assemblies, buckle support assemblies (slide bar-if equipped), shoulder belt height adjusters (if equipped), shoulder belt guide on seat back (if equipped), rear inflatable safety belts (if equipped), child safety seat LATCH and tether anchors, and attaching hardware, should be inspected after a collision. Read the child restraint manufacturer's instructions for additional inspection and maintenance information specific to the child restraint.

# Safety Belts

---

Ford Motor Company recommends that all safety belt assemblies in use in vehicles involved in a collision be replaced. However, if the collision was minor and an authorized dealer finds that the belts do not show damage and continue to operate properly, they do not need to be replaced. Safety belt assemblies not in use during a collision should also be inspected and replaced if either damage or improper operation is noted.

Properly care for safety belts. See **Vehicle Care** (page 302).

# Personal Safety System™

---

The Personal Safety System provides an improved overall level of frontal crash protection to front seat occupants and is designed to help further reduce the risk of airbag-related injuries. The system is able to analyze different occupant conditions and crash severity before activating the appropriate safety devices to help better protect a range of occupants in a variety of frontal crash situations.

The Vehicle Personal Safety System consists of:

- Driver and passenger dual-stage airbag supplemental restraints.
- Front seat outboard safety belts with pretensioners, energy management retractors and safety belt usage sensors.
- Driver seat position sensor.
- Front passenger sensing system.
- Passenger airbag off and on indicator lamp.
- Front crash severity sensors.
- Restraints control module with impact and safing sensors.

- Restraint system warning light and backup tone.
- The electrical wiring for the airbags, crash sensors, safety belt pretensioners, front safety belt usage sensors, driver seat position sensor, front passenger sensing system and indicator lights.

## **How Does the Personal Safety System Work?**

The Personal Safety System can adapt the deployment strategy of the safety devices according to crash severity and occupant conditions. A collection of crash and occupant sensors provides information to the restraints control module. During a crash, the restraints control module may deploy the safety belt pretensioners, one or both stages of the dual-stage airbags based on crash severity and occupant conditions.

# Supplementary Restraints System

## PRINCIPLE OF OPERATION

### WARNINGS



Airbags do not inflate slowly or gently, and the risk of injury from a deploying airbag is the greatest close to the trim covering the airbag module.



All occupants of your vehicle, including the driver, should always properly wear their safety belts, even when an airbag supplemental restraint system is provided. Failure to properly wear your safety belt could seriously increase the risk of injury or death.



Always transport children 12 years old and under in the back seat and always properly use appropriate child restraints. Failure to follow this could seriously increase the risk of injury or death.



Never place your arm over the airbag module as a deploying airbag can result in serious arm fractures or other injuries.

### WARNINGS



Airbags can kill or injure a child in a child seat. Never place a rear-facing child seat in front of an active airbag. If you must use a forward-facing child seat in the front seat, move the seat upon which the child seat is installed all the way back.



Do not attempt to service, repair, or modify the airbag supplemental restraint systems or its fuses as you could be seriously injured or killed. Contact your authorized dealer as soon as possible.



Several airbag system components get hot after inflation. To reduce the risk of injury, do not touch them after inflation.



If the airbag has deployed, the airbag will not function again and must be replaced immediately. If the airbag is not replaced, the unrepaired area will increase the risk of injury in a crash.

The airbags are a supplemental restraint system and are designed to work with the safety belts to help protect the driver and right front passenger from certain upper body injuries. Airbags do not inflate slowly; there is a risk of injury from a deploying airbag.

**Note:** *You will hear a loud bang and see a cloud of harmless powdery residue if an airbag deploys. This is normal.*

The airbags inflate and deflate rapidly upon activation. After airbag deployment, it is normal to notice a smoke-like, powdery residue or smell the burnt propellant. This may consist of cornstarch, talcum powder (to lubricate the bag) or sodium compounds (for example, baking soda) that result from the combustion process that inflates the airbag. Small amounts of sodium hydroxide may be present which may irritate the skin and eyes, but none of the residue is toxic.

# Supplementary Restraints System

While the system is designed to help reduce serious injuries, contact with a deploying airbag may also cause abrasions or swelling. Temporary hearing loss is also a possibility as a result of the noise associated with a deploying airbag. Because airbags must inflate rapidly and with considerable force, there is the risk of death or serious injuries such as fractures, facial and eye injuries or internal injuries, particularly to occupants who are not properly restrained or are otherwise out of position at the time of airbag deployment. Thus, it is extremely important that occupants be properly restrained as far away from the airbag module as possible while maintaining vehicle control.

Routine maintenance of the airbags is not required.

## DRIVER AND PASSENGER AIRBAGS

### WARNINGS



Never place your arm or any objects over an airbag module. Placing your arm over a deploying airbag can result in serious arm fractures or other injuries. Objects placed on or over the airbag inflation area may cause those objects to be propelled by the airbag into your face and torso causing serious injury.



Airbags can kill or injure a child in a child seat. Never place a rear-facing child seat in front of an active airbag. If you must use a forward-facing child seat in the front seat, move the seat upon which the child seat is installed all the way back.

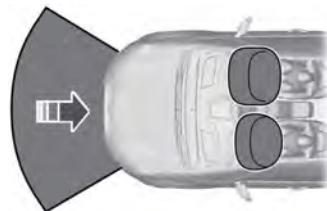

E151127

The driver and front passenger airbags will deploy during significant frontal and near frontal crashes.

The driver and passenger front airbag system consists of:

- Driver and passenger airbag modules.
- Front passenger sensing system.



• Crash sensors and monitoring system with readiness indicator. See **Crash Sensors and Airbag Indicator** (page 51).

# Supplementary Restraints System

## Proper Driver and Front Passenger Seating Adjustment

### WARNING

 National Highway Traffic Safety Administration (NHTSA) recommends a minimum distance of at least 10 inches (25 centimeters) between an occupant's chest and the driver airbag module.

To properly position yourself away from the airbag:

- Move your seat to the rear as far as you can while still reaching the pedals comfortably.
- Recline the seat slightly (one or two degrees) from the upright position.

After all occupants have adjusted their seats and put on safety belts, it is very important that they continue to sit properly. A properly seated occupant sits upright, leaning against the seat back, and centered on the seat cushion, with their feet comfortably extended on the floor. Sitting improperly can increase

the chance of injury in a crash event. For example, if an occupant slouches, lies down, turns sideways, sits forward, leans forward or sideways, or puts one or both feet up, the chance of injury during a crash is greatly increased.

## Children and Airbags

### WARNING

 Airbags can kill or injure a child in a child seat. Never place a rear-facing child seat in front of an active airbag. If you must use a forward-facing child seat in the front seat, move the seat upon which the child seat is installed all the way back.





E142846

Children must always be properly restrained. Accident statistics suggest that children are safer when properly restrained in the rear seating positions than in the front seating position. Failure to follow these instructions may increase the risk of injury in a crash.

## FRONT PASSENGER SENSING SYSTEM

### WARNINGS

 Even with Advanced Restraints Systems, children 12 and under should be properly restrained in a rear seating position. Failure to follow this could seriously increase the risk of injury or death.

 Sitting improperly out of position or with the seat back reclined too far can take off weight from the seat cushion and affect the decision of the front passenger sensing system, resulting in serious injury or death in a crash. Always sit upright against your seat back, with your feet on the floor.

# Supplementary Restraints System

## WARNINGS



Any alteration or modification to the front passenger seat may affect the performance of the front passenger sensing system which could seriously increase the risk of injury or death.

This system works with sensors that are part of the front passenger's seat and safety belt to detect the presence of a properly-seated occupant and determine if the front passenger's frontal airbag should be enabled (may inflate) or not.

PASS AIRBAG OFF ON

E151849

The front passenger sensing system uses a passenger airbag status indicator that will illuminate indicating that the front passenger frontal airbag is either ON (enabled) or OFF (disabled).

The indicator lamp is located in the center stack of the instrument panel.

**Note:** *The passenger airbag status indicator OFF and ON indicator lamps will illuminate for a short period of time when the ignition is first turned on to confirm it is functional.*

The front passenger sensing system is designed to disable (will not inflate) the front passenger's frontal airbag when the front passenger seat is unoccupied, or a rear facing infant seat, a forward-facing child restraint, or a booster seat is detected. Even with this technology, parents are **strongly** encouraged to always properly restrain children in the rear seat. The sensor also turns off the passenger front airbag and seat-mounted side airbag when the passenger seat is empty.

- When the front passenger sensing system disables (will not inflate) the front passenger frontal airbag, the passenger airbag status indicator will illuminate the OFF lamp and stay lit to remind you that the front passenger frontal airbag is disabled.
- If the child restraint has been installed and the passenger airbag status indicator illuminates the ON lamp, then turn the vehicle off, remove the child restraint from the vehicle and reinstall the restraint following the child restraint manufacturer's instructions.

The front passenger sensing system is designed to enable (may inflate) the front passenger's frontal airbag anytime the system senses that a person of adult size is sitting properly in the front passenger seat.

- When the front passenger sensing system enables the front passenger frontal airbag (may inflate), the passenger airbag status indicator will illuminate the ON lamp and remain illuminated.

# Supplementary Restraints System

If a person of adult size is sitting in the front passenger's seat, but the airbag off indicator lamp is lit, it is possible that the person isn't sitting properly in the seat. If this happens:

- Turn the vehicle off and ask the person to place the seat back in the full upright position.
- Have the person sit upright in the seat, centered on the seat cushion, with the person's legs comfortably extended.
- Restart the vehicle and have the person remain in this position for about two minutes. This will allow the system to detect that person and enable the passenger's frontal airbag.
- If the indicator OFF lamp remains lit even after this, the person should be advised to ride in the rear seat.

Occupant	Passenger airbag status indicator	Passenger airbag
Empty	OFF: Lit	Disabled
	ON: Unlit	
Child	OFF: Lit	Disabled
	ON: Unlit	
Adult	OFF: Unlit	Enabled
	ON: Lit	

**Note:** When the passenger airbag status indicator OFF light is illuminated, the passenger (seat mounted) side airbag may be disabled to avoid the risk of airbag deployment injuries.

After all occupants have adjusted their seats and put on safety belts, it is very important that they continue to sit properly. A properly seated occupant sits upright, leaning against the seat back, and centered on the seat cushion, with their feet comfortably extended

# Supplementary Restraints System

on the floor. Sitting improperly can increase the chance of injury in a crash event. For example, if an occupant slouches, lies down, turns sideways, sits forward, leans forward or sideways, or puts one or both feet up, the chance of injury during a crash is greatly increased.

The conditions listed above may cause the weight of a properly seated occupant to be incorrectly interpreted by the front passenger sensing system. The person in the front passenger seat may appear heavier or lighter due to the conditions described in the list above.



To know if the front passenger sensing system is operating properly, See **Crash Sensors and Airbag Indicator** (page 51).

Do not attempt to repair or service the system. Take your vehicle immediately to an authorized dealer.

If it is necessary to modify an advanced front airbag system to accommodate a person with disabilities, contact the Ford Customer Relationship Center. See **Getting the Services You Need** (page 260).

## SIDE AIRBAGS

### WARNINGS



Do not place objects or mount equipment on or near the airbag cover, on the side of the seatbacks (of the front seats), or in front seat areas that may come into contact with a deploying airbag. Failure to follow these instructions may increase the risk of personal injury in the event of a crash.



Do not use accessory seat covers. The use of accessory seat covers may prevent the deployment of the side airbags and increase the risk of injury in an accident.



Do not lean your head on the door. The side airbag could injure you as it deploys from the side of the seatback.



Do not attempt to service, repair, or modify the airbag, its fuses or the seat cover on a seat containing an airbag as you could be seriously injured or killed. Contact your authorized dealer as soon as possible.

### WARNINGS



If the side airbag has deployed, the airbag will not function again. The side airbag system (including the seat) must be inspected and serviced by an authorized dealer. If the airbag is not replaced, the unrepared area will increase the risk of injury in a crash.

The side airbags are located on the outboard side of the seatbacks of the front seats. In certain sideways crashes, the airbag on the side affected by the crash will be inflated. The airbag was designed to inflate between the door panel and occupant to further enhance the protection provided occupants in side impact crashes.

# Supplementary Restraints System



E152533

The system consists of the following:

- A label or embossed side panel indicating that side airbags are fitted to your vehicle.
- Side airbags located inside the driver and front passenger seatbacks.
- Front passenger sensing system.



• Crash sensors and monitoring system with readiness indicator. See **Crash Sensors and Airbag Indicator** (page 51).

**Note:** *The passenger sensing system will deactivate the passenger seat-mounted side airbag if it detects an empty passenger seat.*

The design and development of the side airbag system included recommended testing procedures that were developed by a group of automotive safety experts known as the Side Airbag Technical Working Group. These recommended testing procedures help reduce the risk of injuries related to the deployment of side airbags.

## DRIVER AND PASSENGER KNEE AIRBAGS

Driver and passenger knee airbags are located under or within the instrument panel. During a crash, the restraints control module may activate the driver and passenger knee airbags (individually or both) based on crash severity and respective occupant conditions. Under certain crash and occupant conditions, the driver and passenger knee airbags may deploy (individually or both) but the corresponding front airbag may not activate. As with front and side airbags, it is important to be properly seated and restrained to reduce the risk of death or serious injury.



Make sure the knee airbags are operating properly. See **Crash Sensors and Airbag Indicator**

(page 51).

## SIDE CURTAIN AIRBAGS

### WARNINGS



Do not place objects or mount equipment on or near the headliner at the siderail that may come into contact with a deploying side curtain airbag. Failure to follow these instructions may increase the risk of personal injury in the event of a crash.



Do not lean your head on the door. The side curtain airbag could injure you as it deploys from the headliner.





Do not attempt to service, repair, or modify the side curtain airbags, its fuses, the A, B, or C pillar trim, or the headliner on a vehicle containing side curtain airbags. Contact your authorized dealer as soon as possible.

# Supplementary Restraints System

## WARNINGS

 All occupants of the vehicle including the driver should always wear their safety belts even when an airbag supplemental restraint system and side curtain airbag is provided.

 To reduce risk of injury, do not obstruct or place objects in the deployment path of the side curtain airbag.

 If the side curtain airbags have deployed, the side curtain airbags will not function again. The side curtain airbags (including the A, B and C pillar trim and headliner) must be inspected and serviced by an authorized dealer. If the side curtain airbag is not replaced, the unrepaired area will increase the risk of injury in a crash.

The side curtain airbags will deploy during significant side crashes. The side curtain airbags are mounted to the roof side-rail sheet metal, behind the headliner, above each row of seats. In certain sideways crashes, the side curtain airbag on the impacted side of the vehicle will be activated. The side curtain airbags are designed to inflate between the side window area and occupants to further enhance protection provided in side impact crashes.

The system consists of the following:

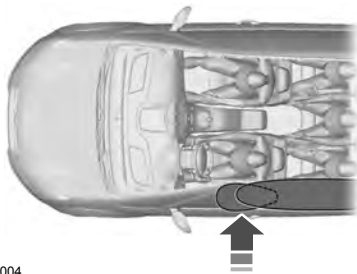

E75004

- Side curtain airbags located above the trim panels over the front and rear side windows identified by a label or wording on the headliner or roof-pillar trim.
- A flexible headliner which opens above the side doors to allow side air curtain deployment.



Crash sensors and monitoring system with readiness indicator. See **Crash Sensors and Airbag Indicator** (page 51).

Children 12 years old and under should always be properly restrained in the back seats. The side curtain airbags will not interfere with children restrained using a properly installed child or booster seat because it is designed to inflate downward from the headliner above the doors along the side window opening.

# Supplementary Restraints System

The design and development of the side curtain airbags included recommended testing procedures that were developed by a group of automotive safety experts known as the Side Airbag Technical Working Group. These recommended testing procedures help reduce the risk of injuries related to the deployment of side curtain airbags.

## CRASH SENSORS AND AIRBAG INDICATOR

### WARNING



Modifying or adding equipment to the front end of the vehicle (including frame, bumper, front end body structure and tow hooks) may affect the performance of the airbag system, increasing the risk of injury. Do not modify the front end of the vehicle.

Your vehicle has a collection of crash and occupant sensors which provide information to the restraints control module. The restraints control module deploys (activates) the front safety belt pretensioners, driver airbag, passenger airbag, knee airbag(s), seat mounted side airbags, side curtain airbags and optional rear inflatable safety belts. Based on the type of crash (frontal impact or side impact), the restraints control module will deploy the appropriate safety devices.

The restraints control module also monitors the readiness of the above safety devices plus the crash and occupant sensors. The readiness of the safety system is indicated by a warning indicator light in the instrument cluster or by a backup tone if the warning light is not working. Routine maintenance of the airbag is not required.

A difficulty with the system is indicated by one or more of the following:



The readiness light will not illuminate immediately after the ignition is turned on.

- The readiness light will either flash or stay lit.
- A series of five beeps will be heard. The tone pattern will repeat periodically until the problem, the light or both are repaired.

If any of these things happen, even intermittently, have the supplemental restraint system serviced at an authorized dealer immediately. Unless serviced, the system may not function properly in the event of a crash.

The safety belt pretensioners and the front airbag supplemental restraint system are designed to activate when the vehicle sustains frontal deceleration sufficient to cause the restraints control module to deploy a safety device.

# Supplementary Restraints System

---

The fact that the safety belt pretensioners or front airbags did not activate for both front seat occupants in a crash does not mean that something is wrong with the system. Rather, it means the restraints control module determined the accident conditions (crash severity, belt usage) were not appropriate to activate these safety devices.

- The design of the front airbags is to activate only in frontal and near-frontal crashes (not rollovers, side impacts or rear impacts) unless the crash causes sufficient frontal deceleration.
- The safety belt pretensioners and optional rear inflatable safety belts are designed to activate in frontal, near-frontal and side crashes.
- The knee airbag(s) may deploy based on crash severity and occupant conditions.
- The design of the side airbags and side curtain airbags is to inflate in certain side impact crashes. Side airbags and side curtain airbags may activate in other types of crashes if the vehicle experiences sufficient sideways motion or deformation.

## **AIRBAG DISPOSAL**

Contact your authorized dealer as soon as possible. Airbags must be disposed of by qualified personnel.

# Keys and Remote Controls

---

## GENERAL INFORMATION ON RADIO FREQUENCIES

This device complies with Part 15 of the FCC Rules and with Industry Canada license-exempt RSS standard(s). Operation is subject to the following two conditions: (1) This device may not cause harmful interference, and (2) This device must accept any interference received, including interference that may cause undesired operation.

**Note:** *Changes or modifications not expressly approved by the party responsible for compliance could void the user's authority to operate the equipment. The term **IC** before the radio certification number only signifies that Industry Canada technical specifications were met.*

The typical operating range for your transmitter is approximately 33 feet (10 meters). Vehicles with the remote start feature will have a greater range. One of the following could cause a decrease in operating range:

- weather conditions
- nearby radio towers
- structures around the vehicle
- other vehicles parked next to your vehicle

Other short-distance radio transmitters, such as amateur radios, medical equipment, wireless headphones, remote controls and alarm systems may operate on the same frequency as your remote control. If other transmitters are operating on those frequencies, you may not be able to use your remote control. Using your remote control near some types of electronic equipment, such as USB devices, computers or cell phones can interfere with remote operation. Operating your remote control near metal or metallic-finished purses, bags or clothing can interfere with remote operation. You can lock and unlock the doors with the key.

**Note:** *Make sure to lock your vehicle before leaving it unattended.*

**Note:** *If you are in range, the remote control will operate if you press any button unintentionally.*

## Intelligent Access

The system uses a radio frequency signal to communicate with your vehicle and authorize your vehicle to unlock when one of the following conditions are met:

- You touch the inside of the front exterior door handle.
- You press the luggage compartment button.
- You press a button on the transmitter.

If excessive radio frequency interference is present in the area or if the transmitter battery is low, you may need to mechanically unlock your door. You can use the mechanical key blade in your intelligent access key to open the driver door in this situation. See **Remote Control** (page 54).

# Keys and Remote Controls

## REMOTE CONTROL

### Intelligent Access Key



E144506

Your intelligent access keys operate the power locks and the remote start system. The key must be in your vehicle to activate the push-button start system.

### Removable Key Blade

The intelligent access key also contains a removable mechanical key blade that you can use to lock or unlock the driver door.



E151796

Slide the release on the back of the remote control and pivot the cover off to access the key blade.

If the central locking function fails to operate, you can lock the doors individually using the key blade in the position shown.

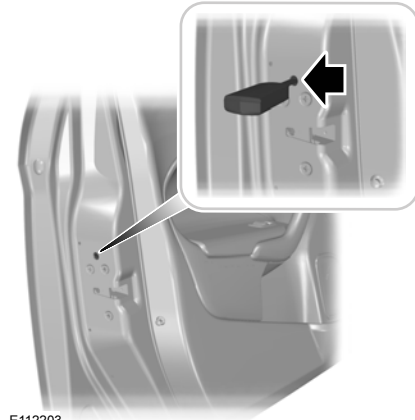

E112203

On the driver's side, turn the key clockwise to lock, and on the passenger side turn the key counterclockwise to lock.

# Keys and Remote Controls



E151795

**Note:** Your vehicle's backup keys came with a security tag that provides important vehicle key cut information. Keep the tag in a safe place for future reference.

## Replacing the Battery

**Note:** Refer to local regulations when disposing of transmitter batteries.

**Note:** Do not wipe off any grease on the battery terminals or on the back surface of the circuit board.

**Note:** Replacing the battery will not delete the transmitter from the vehicle. The transmitter should operate normally.

A message appears in the information display when the remote control battery is low. See **Information Messages** (page 120).

## Intelligent Access Transmitter

The remote control uses two coin-type three-volt lithium batteries CR2025 or equivalent.



E151796

1. Slide the release on the back of the remote control and pivot the cover off.



E153890

2. Insert a coin into the slot and twist to separate the housing.



E153891

3. Remove the batteries.

# Keys and Remote Controls

4. Install new batteries with the + facing each other.

**Note:** *Make sure to replace the label between the two batteries.*

5. Reinstall the housing and cover.

## Car Finder



Press the button twice within three seconds. The horn sounds and direction indicators will flash. We recommend that you use this method to locate your vehicle, rather than using the panic alarm.

## Sounding a Panic Alarm

**Note:** *The panic alarm will only operate when the ignition is off.*



Press the button to activate the alarm. Press the button again or switch the ignition on to deactivate.

## Remote Start

### WARNING



To avoid exhaust fumes, do not use remote start if your vehicle is parked indoors or areas that are not well ventilated.

**Note:** *Do not use remote start if your vehicle is low on fuel.*



The remote start button is on the transmitter.

This feature allows you to start your vehicle from outside the vehicle. The transmitter has an extended operating range.

You can configure automatic climate control to operate when the vehicle is remote started. See **Climate Control** (page 139). Manual climate control systems will run at the setting set when you switched off the vehicle.

Many states and provinces restrict the use of remote start. Check your local and state or provincial laws for specific requirements regarding remote start systems.

The remote start system will not work if:

- The ignition is on.
- The alarm system is triggered.
- You disable the feature.
- The hood is open.
- The transmission is not in **P**.
- The vehicle battery voltage is too low.
- The service engine soon light is on.

## Remote Control Feedback

An LED on the remote control provides status feedback of remote start or stop commands.

# Keys and Remote Controls

LED	Status
Solid green	Remote start or extension successful
Solid red	Remote stop successful; engine off
Blinking red	Remote start or stop failed
Blinking green	Waiting for status update

## Remote Starting the Vehicle

**Note:** You must press each button within three seconds of each other. Your vehicle will not remote start if you do not follow this sequence.

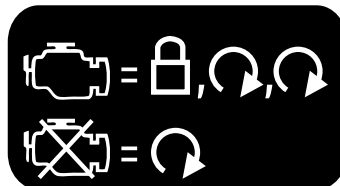

E138626

The tag with your transmitter details the starting procedure.

To remote start your vehicle:

1. Press the lock button to lock all the doors.
2. Press the remote start button twice. The exterior lamps will flash twice.

The horn will sound if the system fails to start, unless quiet start is on. Quiet start will run the blower fan at a slower speed to reduce noise. It can be switched on or off in the information display. See (page 109).

**Note:** If the vehicle has been remote started with an integrated keyhead transmitter, you must switch the ignition on before driving your vehicle. With an intelligent access transmitter, you must press the **START/STOP** button on the instrument panel once while applying the brake pedal before driving your vehicle.

The power windows will not work during the remote start and the radio will not turn on automatically.

The parking lamps will remain on and the vehicle will run for 5, 10, or 15 minutes, depending on the setting.

## Extending the Vehicle Run Time

Repeat Steps 1 and 2 with the vehicle still running to extend the run time for another remote start duration. If you programmed the duration to last 10 minutes, the second 10 minutes will begin after what is left of the first activation time. For example, if the vehicle had been running from the first remote start for five minutes, the vehicle will continue to run now for a total of 15 minutes. You can extend the remote start up to a maximum of 35 minutes.

# Keys and Remote Controls

---

Wait at least five seconds before remote starting after a vehicle shutdown.

## ***Turning the Vehicle Off After Remote Starting***



Press the button once. The parking lamps will turn off.

You may have to be closer to the vehicle than when starting due to ground reflection and the added noise of the running vehicle.

You can disable or enable the remote start system through the information display. See (page 109).

## ***Memory Feature***

You can recall the memory seat position, mirror position, and steering column position (if equipped) with your intelligent access keyfob you link it to a pre-set position. See **Memory Function** (page 149).

## **REPLACING A LOST KEY OR REMOTE CONTROL**

Replacement keys or remote controls can be purchased from an authorized dealer. Authorized dealers can program remote controls for your vehicle. See **Passive Anti-Theft System** (page 75).

To re-program the passive anti-theft system see an authorized dealer.

## PRINCIPLE OF OPERATION

MyKey allows you to program keys with restricted driving modes to promote good driving habits. All but one of the keys programmed to the vehicle can be activated with these restricted modes.

Any keys that have not been programmed are referred to as administrator keys or admin keys. These can be used to:

- create a MyKey
- program configurable MyKey settings
- clear all MyKey features.

When you have programmed a MyKey, you can access the following information using the information display:

- How many admin keys and MyKeys are programmed to your vehicle.
- The total distance your vehicle has traveled using a MyKey.

**Note:** *All MyKeys are programmed to the same settings. You cannot program them individually.*

**Note:** *For vehicles with intelligent access with push-button start, when both a MyKey and an admin intelligent access key fob are present, the admin fob will be recognized by the vehicle while switching the ignition on to start the vehicle.*

## Non-configurable Settings

The following settings cannot be changed by an admin key user:

- Belt-Minder. You cannot disable this feature. The audio system will mute when the front seat occupants' safety belts are not fastened.
- Early low fuel. The low-fuel warning activates earlier, giving the MyKey user more time to refuel.
- Driver assist features, if equipped on your vehicle, are forced on: parking aid, blind spot information system (BLIS) with cross traffic alert, lane departure warning and forward collision warning system.

## Configurable Settings

With an admin key, you can configure certain MyKey settings when you first create a MyKey and before you recycle the key or restart the vehicle. You can also change the settings afterward with an admin key.

- A vehicle speed limit can be set. Warnings will be shown in the display followed by an audible tone when your vehicle reaches the set speed. You cannot override the set speed by fully depressing the accelerator pedal or by setting cruise control.
- Vehicle speed minders of 45, 55 or 65 mph (75, 90 or 105 km/h). Once you select a speed, it will be shown in the display, followed by an audible tone when the preselected vehicle speed is exceeded.

- Audio system maximum volume of 45%. A message will be shown in the display when you attempt to exceed the limited volume. Also, the speed-sensitive or compensated automatic volume control will be disabled.
- Always on setting. When this is selected, you will not be able to turn off Advance Trac (if your vehicle is equipped with this feature).

## CREATING A MYKEY

Use the information display to create a MyKey:

1. Insert the key you want to program into the ignition. If your vehicle is equipped with a push-button start, place the intelligent access key fob into the backup slot. The location of your backup slot is in another chapter. See **Starting and Stopping the Engine** (page 163).
2. Switch the ignition on.

3. Access the main menu on the information display controls, and select **Settings** then **MyKey** by pressing **OK** or the > button.

4. Press **OK** or the > button to select **Create MyKey**.

5. When prompted, hold the **OK** button until you see a message informing you to label this key as a MyKey. The key will be restricted at the next start.

MyKey is successfully created. Make sure you label it so you can distinguish it from the admin keys.

You can also program configurable settings for the key(s). See **Programming/Changing Configurable Settings**.

### Programming/Changing Configurable Settings

Use the information display to access your configurable MyKey settings.

1. Switch the ignition on using an admin key or fob.
2. Access the main menu on the information display controls, and select **Settings**, then **MyKey** by pressing **OK** or > button.
3. Use the arrow buttons to get to a feature.
4. Press **OK** or > to make a selection.

**Note:** *You can clear or change your MyKey settings at any time during the same key cycle as you created the MyKey. Once you have switched the vehicle off, however, you will need an admin key to change or clear your MyKey settings.*

## CLEARING ALL MYKEYS

You can clear or change your MyKey settings using the information display control on the steering wheel. See **Information Displays** (page 109).

Switch the ignition on using an admin key or fob.

# MyKey™

---

To clear all MyKeys of all MyKey settings, press the left arrow button to access the main menu and scroll to:

Message	Action and Description
Settings	Press the <b>OK</b> button.
MyKey	Press the <b>OK</b> button.
Clear MyKey	Press and hold the <b>OK</b> button until the following message displays.
All MyKeys Cleared	

**Note:** When you clear your MyKeys, you remove all restrictions and return all MyKeys to their original admin key status.

## CHECKING MYKEY SYSTEM STATUS

You can find information on programmed MyKey(s) using the information display control on the steering wheel. See **Information Displays** (page 109).

To find information on a programmed MyKey(s), press the left arrow button to access the main menu and scroll to:

Message	Description
Settings	Press the <b>OK</b> button.
MyKey	Press the <b>OK</b> button.
<b>Select one of the following:</b>	
MyKey Dist.	Tracks the distance when drivers use a MyKey. The only way to delete the accumulated distance is by using an admin key to clear your MyKey. If the distance does not accumulate as expected, then the intended user is not using the MyKey, or an admin key user recently cleared and then recreated a MyKey.
{0} MyKeys	Indicates the number of MyKeys programmed to your vehicle. Use this feature to detect how many MyKeys you have for your vehicle and determine when a MyKey has been deleted.
{0} Admin Keys	Indicates how many admin keys are programmed to your vehicle. Use this feature to determine how many unrestricted keys you have for your vehicle, and detect if an additional MyKey has been programmed.

## USING MYKEY WITH REMOTE START SYSTEMS

MyKey is not compatible with non

Ford-approved, aftermarket remote start systems. If you choose to install a remote start system, see an authorized dealer for a Ford-approved remote start system.

## MYKEY TROUBLESHOOTING

Condition	Potential Causes
I cannot create a MyKey.	<ul style="list-style-type: none"> <li>• The key or transmitter used to start the vehicle does not have admin privileges.</li> <li>• The key or transmitter used to start the vehicle is the only admin key (there always has to be at least one admin key).</li> <li>• Vehicles with keyless start: The keyless start transmitter is not placed in the backup slot, located in the center console. See <b>Keyless Entry</b> (page 70).</li> <li>• SecuriLock passive anti-theft system is disabled or in unlimited mode.</li> </ul>
I cannot program the configurable settings.	<ul style="list-style-type: none"> <li>• The key or transmitter used to start your vehicle does not have admin privileges.</li> <li>• No MyKeys are created. See <b>Creating a MyKey</b> (page 60).</li> </ul>
I cannot clear the MyKeys.	<ul style="list-style-type: none"> <li>• The key or transmitter used to start your vehicle does not have admin privileges.</li> <li>• No MyKeys are created. See <b>Creating a MyKey</b> (page 60).</li> </ul>
I lost the only admin key.	Purchase a new key from an authorized dealer.
I lost a key.	Program a spare key. See <b>Passive Anti-Theft System</b> (page 75).
MyKey distances do not accumulate.	<ul style="list-style-type: none"> <li>• The MyKey user is not using the MyKey.</li> <li>• An admin key holder cleared the MyKeys and created new MyKeys.</li> </ul>

# MyKey™

---

Condition	Potential Causes
	<ul style="list-style-type: none"><li>• The key system has been reset.</li></ul>
No MyKey functions with the keyless entry transmitter.	<ul style="list-style-type: none"><li>• An admin transmitter is present at vehicle start.</li><li>• No MyKeys are created. See <b>Creating a MyKey</b> (page 60).</li></ul>

# Locks

## LOCKING AND UNLOCKING

You can use the power door lock control or the remote control to lock and unlock your vehicle.

### Power Door Locks

The power door lock control is on the driver and front passenger door panels.



E138628

- A Unlock
- B Lock

### Door Lock Indicator

An LED on each door window trim will light when you lock the door. It will remain lit for up to 10 minutes after you switch off the ignition.

### Switch Inhibitor

When you electronically lock your vehicle, the power door lock switch and interior trunk release switch will no longer operate after 20 seconds. You must unlock your vehicle with the remote control or keyless keypad, or switch the ignition on, to restore function to these switches. You can switch this feature on or off in the information display. See (page 109).

### Rear Door Unlocking and Opening

Pull the interior door release handle twice to unlock and open the rear door. The first pull unlocks the door and the second pull will unlatch the door.

### Remote Control

You can use the remote control at any time. The luggage compartment release button only works when your vehicle speed is less than 5 mph (8 km/h).

### Unlocking the Doors (Two-Stage Unlock)



Press the button to unlock the driver door.

Press the button again within three seconds to unlock all doors. The turn signals will flash.

Press and hold both the lock and unlock buttons on the remote control for three seconds to change between driver door or all doors unlock mode. The turn signals will flash twice to indicate a change to the unlocking mode. Driver door unlock mode will only unlock the driver door when the unlock button is pressed once. All door

# Locks

unlock mode unlocks all doors with one press of the unlock button. The unlocking mode applies to the remote control, keyless entry keypad and intelligent access. You can also change the mode in the information display. See (page 109).

## Locking the Doors



Press the button to lock all the doors. The turn signals will illuminate.

Press the button again within three seconds to confirm that all the doors are closed. The doors will lock again, the horn will sound and the turn signals will illuminate if all the doors and the luggage compartment are closed.

## Mislock

If any door or the luggage compartment is open, or if the hood is open on vehicles with an anti-theft alarm or remote start, the horn will sound twice and the lamps will not flash. You can enable or disable this feature in the information display. See (page 109).

## Opening the Luggage Compartment



Press twice within three seconds to open the luggage compartment.

Make sure to close and latch the luggage compartment before driving your vehicle. An unlatched luggage compartment may cause objects to fall out or block your view.

## Activating Intelligent Access

You must have the intelligent access key within 3 feet (1 meter) of your vehicle.

## At a Door

Pull an exterior door handle to unlock and open the door. Make sure not to touch the lock sensor on top of the handle.



E146044

Touch the top of the door handle to lock your vehicle. There will be a brief delay before you can unlock your vehicle again.

**Note:** *Keep the door handle surface clean to avoid issues with operation.*

# Locks

## At the Luggage Compartment

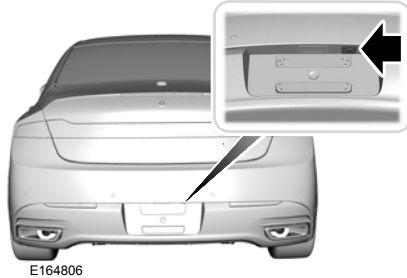

Press the exterior release button hidden above the license plate.

## Smart Unlocks

This feature helps to prevent you from unintentionally locking your intelligent access key inside your vehicle's passenger compartment or rear cargo area.

When you electronically lock your vehicle (with any door open, vehicle in park and ignition off), your vehicle will search for an intelligent access key in the passenger compartment after you close the last door. If your vehicle finds a key, all of the doors will immediately unlock and the horn will sound twice, indicating that a key is inside.

You can override the smart unlock feature and intentionally lock the intelligent access key inside your vehicle. To do this, lock your vehicle after you have closed all the doors by:

- using the keyless entry keypad
- pressing the lock button on another intelligent access key
- touching the locking area on the handle with another intelligent access key in your hand.

When you open one of the front doors and lock your vehicle using the power door lock control, all doors will lock then unlock if:

- the ignition is on, or
- the ignition is off and your vehicle is not in **P**.

## Auto Relock

If you press the unlock button on the remote control and do not open a door within 45 seconds, your vehicle will lock and the alarm will arm. You can enable or disable this feature in the information display. See (page 109).

## Autolock Feature

The autolock feature will lock all the doors when:

- all doors are closed,
- the ignition is on,
- you shift into any gear putting your vehicle in motion, and
- your vehicle attains a speed greater than 12 mph (20 km/h).

The autolock feature repeats when:

- you open then close any door while the ignition is on and your vehicle speed is 9 mph (15 km/h) or lower, and
- your vehicle then attains a speed greater than 12 mph (20 km/h).

# Locks

## Autounlock Feature

The autounlock feature will unlock all the doors when:

- the ignition is on, all the doors are closed, and your vehicle has been in motion at a speed greater than 12 mph (20 km/h);
- your vehicle comes to a stop and you switch the ignition off or to accessory; and
- you open the driver door within 10 minutes of switching the ignition off or to accessory.

**Note:** *The doors will not autounlock if you electronically lock your vehicle after you switch the ignition off and before you open the driver door.*

## Enabling or Disabling

**Note:** *You can enable or disable the autolock and autounlock features independently of each other.*

You can enable or disable these features in the information display or your authorized dealer can do it for you. See (page 109).

## Illuminated Entry

The interior lamps and select exterior lamps will illuminate when you unlock the doors with the remote entry system.

The illuminated entry system will turn off the lights if:

- the ignition is on,
- you press the remote control lock button, or
- after 25 seconds of illumination.

The lights will not turn off if:

- you turn them on with the lamp control, or
- any door is open.

## Illuminated Exit

The interior lamps and select exterior lamps will illuminate when all doors are closed and you switch the ignition off.

The lamps will turn off if all the doors remain closed and:

- 25 seconds elapse
- you press the **START/STOP** button.

## Battery Saver

If you leave the courtesy lamps, dome lamps or headlamps on, the battery saver will shut them off 10 minutes after you switch the ignition off.

## Accessory Mode Battery Saver for Intelligent Access Keys

If you leave your vehicle in the run ignition state, it will shut off once it detects a certain amount of battery drain or after 45 minutes.

## Luggage Compartment

### From Inside Your Vehicle



Press the button on the instrument panel to unlatch the trunk.

### With the Remote Control



Press twice within three seconds to unlatch the trunk.

# Locks

## From Outside Your Vehicle

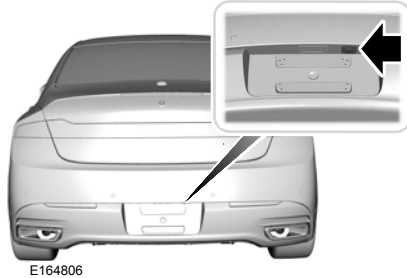

Press the release button above the license plate to unlatch the trunk. Your vehicle must be unlocked or have an intelligent access transmitter within 3 feet (1 meter) of the trunk.

## Power Decklid (If Equipped)

### WARNINGS

 Make sure all persons are clear of the power decklid area before using the power decklid control.

### WARNINGS

 Keep keys out of the reach of children. Do not allow children to operate the power decklid, or to play near to an open or moving power decklid.

**Note:** Do not drive with the decklid open unless you disable the power feature. Make sure you secure the decklid to your vehicle.

You can enable or disable the power decklid using the information display. The remote control and instrument panel button will still operate the decklid regardless of the setting.

## Opening and Closing the Power Decklid

**Note:** You can reverse the decklid movement. Press the instrument panel or decklid button again, or press the remote control button twice.

The decklid will only operate with your vehicle in **P**.

If the decklid reverses or starts to close after an open request, you will hear a fast continuous chime. This indicates excessive load on the decklid or a possible torsion bar failure. See your authorized dealer if you still have a fast chime after you remove the load.

## From Inside Your Vehicle



Press the button on the instrument panel.

## With the Remote Control



Press twice within three seconds.

# Locks

## From Outside Your Vehicle

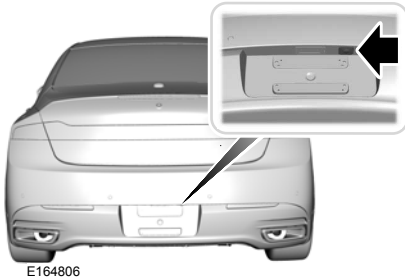

Press the control button located above the license plate. Your vehicle must be unlocked or have the intelligent access transmitter within 3 feet (1 meter) of the decklid to open it.

**Note:** Let the power system operate the decklid after pressing the control. Pushing or pulling the decklid may activate the obstacle detection feature and stop the power operation.

## With the Decklid Close Button



Press the button inside the decklid on the left side.

## Obstacle Detection

The decklid will reverse to full open if it detects an obstacle while closing. Three chimes will sound as the decklid begins to reopen. Remove the obstacle to close the decklid.

**Note:** Before driving off, check the instrument cluster for a trunk ajar or door ajar message or warning indicator. Failure to do this could result in unintentionally leaving the decklid open while driving.

The decklid will stop and three chimes will sound if it detects an obstacle while opening. Remove the obstacle to operate the decklid.

## Resetting the Power Decklid

The decklid may not operate properly and you may need to reset it if:

- the battery is dead or has low voltage
- you disconnect the battery
- you manually close the decklid and leave it unlatched.

To reset the power decklid:

1. Disconnect the battery for 20 seconds then reconnect the battery.
2. Manually close and fully latch the decklid.
3. Power open the decklid using the remote control or instrument panel button.

## KEYLESS ENTRY

### SECURICODE™ KEYLESS ENTRY KEYPAD

The keypad is located near the driver window. It is invisible until touched and then it lights up so you can see and touch the appropriate buttons.

**Note:** If you enter your entry code too fast on the keypad, the unlock function may not work. Re-enter your entry code more slowly.

# Locks

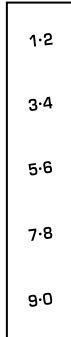

E138637

You can use the keypad to:

- lock or unlock the doors
- recall memory seat and mirror positions
- program and erase personal entry codes
- arm and disarm the anti-theft alarm
- release the trunk.

**Note:** *The keypad will not operate a power decklid.*

You can operate the keypad with the factory-set 5-digit entry code. The code is located on the owner's wallet card in the glove box and is available from an authorized dealer. You can also create up to five of your own 5-digit personal entry codes.

## Programming a Personal Entry Code

To create your own personal entry code:

1. Enter the factory-set code.
2. Press **1-2** on the keypad within five seconds.
3. Enter your personal 5-digit code. You must enter each number within five seconds of each other.
4. Press **1-2** on the keypad to save personal code 1.

The doors will lock then unlock to confirm that programming was successful.

To program additional personal entry codes, repeat Steps 1-3, then for Step 4:

- press **3-4** to save personal code 2
- press **5-6** to save personal code 3

- press **7-8** to save personal code 4
- press **9-0** to save personal code 5.

You may also program a personal entry code through the MyLincoln Touch system. See **Settings** (page 372).

## Tips:

- Do not set a code that uses five of the same number.
- Do not use five numbers in sequential order.
- The factory-set code will work even if you have set your own personal code.

## Recalling Memory Positions

The programmed entry codes will recall driver memory positions as follows:

- Entry code 1 will recall driver 1 memory positions.
- Entry code 2 will recall driver 2 memory positions.
- Entry code 3 will recall driver 3 memory positions.

**Note:** *Personal entry codes 4 and 5 will not recall memory positions.*

# Locks

## Erasing a Personal Code

1. Enter the factory-set 5-digit code.
2. Press and release **1-2** on the keypad within five seconds.
3. Press and hold **1-2** for two seconds. You must do this within five seconds of completing Step 2.

All personal codes are now erased and only the factory-set 5–digit code will work.

## Anti-Scan Feature

The keypad will go into an anti-scan mode if you enter the wrong code seven times (35 consecutive button presses). This mode disables the keypad for one minute and the keypad lamp will flash.

The anti-scan feature will turn off after:

- one minute of keypad inactivity
- pressing the unlock button on the remote control
- switching the ignition on
- unlocking your vehicle using intelligent access.

## Unlocking and Locking the Doors

### To Unlock the Driver Door

Enter the factory-set 5-digit code or your personal code. You must press each number within five seconds of each other. The interior lamps will illuminate.

**Note:** All doors will unlock if you enable the all-door unlocking mode. See **Locking and Unlocking** (page 65).

### To Unlock All Doors

Enter the factory-set code or your personal code, then press **3-4** within five seconds.

### To Lock All Doors

Press and hold **7-8** and **9-0** at the same time (with the driver door closed). You do not need to enter the keypad code first.

### To Release the Trunk

Enter the factory-set code or your personal code, then press **5-6** within five seconds.

## Displaying the Factory Set Code

**Note:** You will need to have two programmed intelligent access keys for this procedure.

To display the factory-set code in the information display:

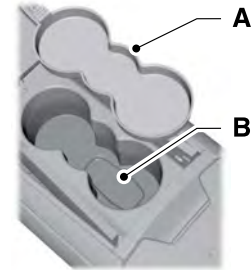

E155835

1. Remove the rubber covering (A) in the cupholder. Place the first programmed key in the backup slot (B) at the bottom of the cupholder.
2. Press the **START/STOP** button once and wait a few seconds.
3. Press the **START/STOP** button again and remove the key.

# Locks

4. Insert the second programmed key into the backup slot, then press the **START/STOP** button.

The factory-set code will appear in the information display for a few seconds.

**Note:** *The code may not display until after any other warning messages first display.*

## INTERIOR LUGGAGE COMPARTMENT RELEASE

### WARNINGS

 Keep vehicle doors and luggage compartment locked and keep keys and remote transmitters out of a child's reach. Unsupervised children could lock themselves in the trunk and risk injury. Children should be taught not to play in vehicles.

### WARNINGS

 Do not leave children, unreliable adults, or animals unattended in the vehicle. On hot days, the temperature in the trunk or vehicle interior can rise very quickly. Exposure of people or animals to these high temperatures for even a short time can cause death or serious heat-related injuries, including brain damage. Small children are particularly at risk.

Your vehicle is equipped with a release handle that provides a means of escape for children and adults if they become locked inside the luggage compartment.

Adults should familiarize themselves with the operation and location of the release handle.

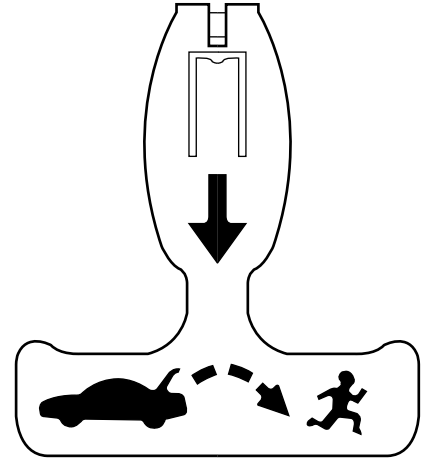

E144403

# Locks

---

The handle is located inside the luggage compartment either on the luggage compartment door (lid) or near the tail lamps. It is composed of a material that will glow for hours in darkness following brief exposure to ambient light.

Pull the handle and push up on the luggage compartment door (lid) to open from within the luggage compartment.

# Security

---

## PASSIVE ANTI-THEFT SYSTEM

**Note:** *The system is not compatible with non-Ford aftermarket remote start systems. Use of these systems may result in vehicle starting problems and a loss of security protection.*

**Note:** *Metallic objects, electronic devices or a second coded key on the same key chain may cause vehicle starting problems if they are too close to the key when starting your vehicle. Prevent these objects from touching the coded key while starting your vehicle. Switch the ignition off, move all objects on the key chain away from the coded key and restart your vehicle if a problem occurs.*

**Note:** *Do not leave a duplicate coded key in your vehicle. Always take your keys and lock all doors when leaving your vehicle.*

## SecuriLock

The system helps prevent your vehicle from starting unless you use a coded key programmed to your vehicle. Using the wrong key may prevent your vehicle from starting. A message may appear in the information display.

If you are unable to start your vehicle with a correctly coded key, it is not operating properly. A message may appear in the information display.

### Automatic Arming

Your vehicle arms immediately after switching the ignition off.

### Automatic Disarming

Switching the ignition on with a coded key disarms your vehicle.

### Replacement Keys

**Note:** *Your vehicle comes equipped with two intelligent access keys.*

The intelligent access key functions as a programmed key that operates the driver door lock and activates the intelligent access with push button start system, as well as a remote control.

If your programmed transmitters are lost or stolen and you do not have an extra coded key, have your vehicle towed to an authorized dealer. You need to erase the key codes from your vehicle and program new coded keys.

Store an extra programmed key away from your vehicle in a safe place to help prevent any inconveniences. See your authorized dealer to purchase additional spare or replacement keys.

### Programming a Spare Intelligent Access Key

**Note:** *You can program a maximum of four intelligent access keys to your vehicle.*

# Security

You must have two previously programmed intelligent access keys inside your vehicle and the new unprogrammed intelligent access keys readily accessible. See an authorized dealer to have the spare key programmed if two previously programmed keys are not available.

Make sure that your vehicle is off before beginning this procedure. Make sure that you close all the doors before beginning and that they remain closed throughout the procedure. Perform all steps within 30 seconds of starting the sequence. Stop and wait for at least one minute before starting again if you perform any steps out of sequence.

Read and understand the entire procedure before you begin.

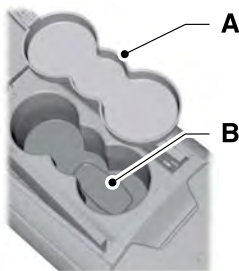

E155835

1. Remove the rubber covering (A) from the cupholder. Place the first programmed key in the backup slot (B) at the bottom of the cupholder, then press the push button ignition switch.
2. Wait five seconds and then press the push button ignition switch again.
3. Remove the intelligent access key.
4. Within 10 seconds, place a second programmed intelligent access key in the backup slot. Press the push button ignition switch.
5. Wait five seconds and then press the push button ignition switch again.
6. Remove the intelligent access key.

7. Place the unprogrammed intelligent access key in the backup slot and press the push button ignition switch.

Programming is now complete. Verify the remote control functions operate and your vehicle starts with the new intelligent access key.

If programming was not successful, wait 10 seconds and repeat Steps 1 through 7. If you are still unsuccessful, take your vehicle to your authorized dealer.

## **ANTI-THEFT ALARM** (If Equipped)

The system will warn you of an unauthorized entry to your vehicle. It will be triggered if any door, the luggage compartment or the hood is opened without using the key, remote control or keyless entry keypad.

The direction indicators will flash and the horn will sound if unauthorized entry is attempted while the alarm is armed.

Take all remote controls to an authorized dealer if there is any potential alarm problem with your vehicle.

## Arming the Alarm

The alarm is ready to arm when there is not a key in the ignition. Electronically lock the vehicle to arm the alarm.

## Disarming the Alarm

Disarm the alarm by any of the following actions:

- Unlock the doors or luggage compartment with the remote control or keyless entry keypad.
- Switch the ignition on or start the vehicle.
- Use a key in the driver's door to unlock the vehicle, then switch the ignition on within 12 seconds.

**Note:** *Pressing the panic button on the remote control will stop the horn and signal indicators, but will not disarm the system.*

# Steering Wheel

## ADJUSTING THE STEERING WHEEL

### WARNING

 Do not adjust the steering wheel when your vehicle is moving.

**Note:** Make sure that you are sitting in the correct position. See **Sitting in the Correct Position** (page 144).

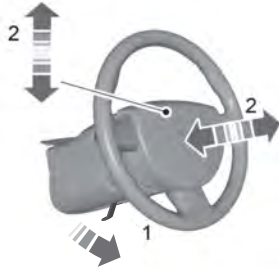

E157083

1. Unlock the steering column.
2. Adjust the steering wheel to the desired position.



E157084

3. Lock the steering column.

### Power Tilt and Telescope Steering Column (If Equipped)

### WARNING

 Do not adjust the steering wheel when your vehicle is moving.

**Note:** Make sure that you are sitting in the correct position. See **Sitting in the Correct Position** (page 144).



E161834

Use the control on the side of the steering column to adjust the position.

To adjust:

- tilt: press the top or bottom of the control
- telescope: press the front or rear of the control.

# Steering Wheel

The steering column sets a stopping position just short of the end of the column position to prevent damage to the steering column. A new stopping position sets if the steering column encounters an object when tilting or telescoping.

To reset the steering column to its normal stopping position:

1. Press the steering column control again after encountering the new stopping position.
2. Continue pressing the control until it reaches the end of the column position.

A new stopping position is set. The next time you tilt or telescope the steering column, it will stop just short of the end of the column position.

## Memory Feature

You can save and recall the steering column position with the memory function. See **Memory Function** (page 149).

**Note:** *Pressing the adjustment control during memory recall cancels the operation. The column responds to the adjustment control.*

## Easy Entry and Exit Feature

When you switch the ignition off, the steering column will move to the full up position to allow extra room to exit your vehicle. The column will return to the previous setting when you switch the ignition on. You can enable or disable this feature in the information display. See **Information Displays** (page 109).

## AUDIO CONTROL (If Equipped)

You can operate the following functions with the control:

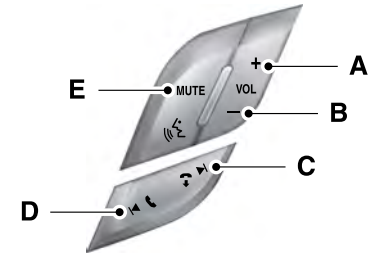

E145979

- A Volume up
- B Volume down
- C Seek up or next
- D Seek down or previous
- E Mute

## Seek, Next or Previous

Press the seek button to:

- tune the radio to the next or previous stored preset
- play the next or the previous track.

# Steering Wheel

Press and hold the seek button to:

- tune the radio to the next station up or down the frequency band
- seek through a track.

## VOICE CONTROL (If Equipped)

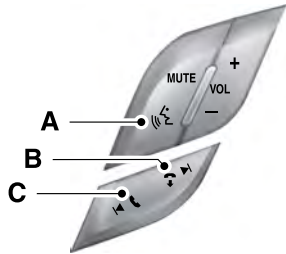

E145980

- A Voice recognition
- B End a call
- C Answer a call

See **MyLincoln Touch™** (page 359).

## CRUISE CONTROL

### Type 1

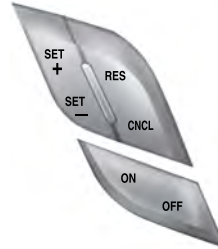

E145976

### Type 2

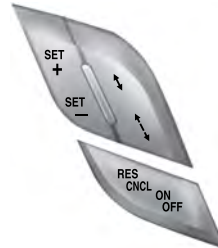

E145977

See **Cruise Control** (page 212).

## INFORMATION DISPLAY CONTROL



E145981

See **Information Displays** (page 109).

## Cluster Display Control Features



E145982

# Steering Wheel

---

Use this control to access some of the MyLincoln Touch features in the information display. Navigate through the screen and press **OK** to select. See **MyLincoln Touch™** (page 359).

## **HEATED STEERING WHEEL** (If Equipped)

See **MyLincoln Touch™** (page 359).

# Wipers and Washers

## WINDSHIELD WIPERS

**Note:** Fully defrost the windshield before switching on the windshield wipers.

**Note:** Make sure you switch off the windshield wipers before entering a car wash.

**Note:** Clean the windshield and wiper blades if they begin to leave streaks or smears. If that does not resolve the issue, install new wiper blades.

**Note:** Do not operate the wipers on a dry windshield. This may scratch the glass, damage the wiper blades or cause the wiper motor to burn out. Always use the windshield washers before wiping a dry windshield.

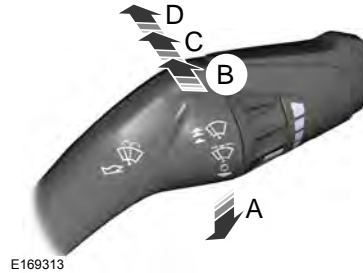

E169313

- A Single wipe
- B Intermittent wipe
- C Normal wipe
- D High speed wipe

## Intermittent Wipe

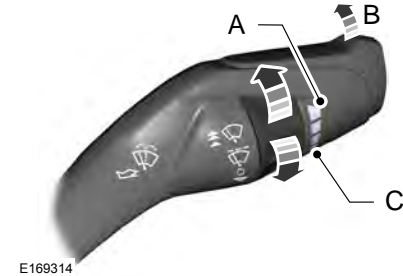

E169314

- A Shortest wipe interval
- B Intermittent wipe
- C Longest wipe interval

Use the rotary control to adjust the intermittent wipe interval.

## Speed Dependent Wipers

When your vehicle speed increases, the interval between wipes will decrease.

# Wipers and Washers

## AUTOWIPERS (If Equipped)

**Note:** Fully defrost the windshield before switching on the windshield wipers.

**Note:** Make sure you switch off the windshield wipers before entering a car wash.

**Note:** Clean the windshield and wiper blades if they begin to leave streaks or smears. If that does not resolve the issue, install new wiper blades.

**Note:** If you switch autolamps on in conjunction with autowipers, your low beam headlamps will illuminate automatically when the rain sensor activates the windshield wipers continuously.

**Note:** Wet or winter driving conditions with ice, snow or salty road mist can cause inconsistent and unexpected wiping or smearing.

In these conditions, you can do the following to help keep your windshield clear:

- Lower the sensitivity of the autowipers to reduce the amount of smearing.
- Switch to normal or high-speed wipe.
- Switch the autowipers off.

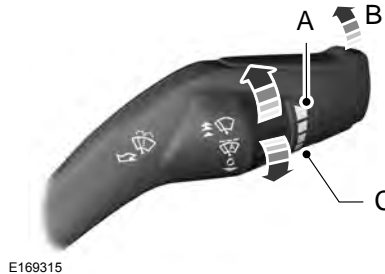

- A Highest sensitivity
- B On
- C Lowest sensitivity

The autowipers feature uses a rain sensor. You will find it in the area around the interior mirror. The rain sensor monitors the amount of moisture on the windshield and automatically turns on the wipers. It will adjust the wiper speed by the amount of moisture that the sensor detects on the windshield.

**Note:** This autowiper feature is automatically set to on and remains on until you switch it off in the information display. You can also switch the feature back on at any time. See (page 109).

Use the rotary control to adjust the sensitivity of the rain sensor. Set the control to low sensitivity, and the wipers will turn on when the rain sensor detects a large amount of moisture on the windshield. Set the control to high sensitivity, and the wipers will turn on when the rain sensor detects a small amount of moisture on the windshield.

# Wipers and Washers

---

**Note:** When you set the wiper system to intermittent wipe and the autowiper system is on, the autowiper sensitivity setting adjusts the wiper speed according to the moisture on the windshield only. Use the wiper lever to wipe the windshield on-demand.

Keep the outside of the windshield clean. The rain sensor is very sensitive. If the area around the mirror is dirty, then the wipers may operate if dirt, mist or insects hit the windshield.

## WINDSHIELD WASHERS

**Note:** Do not operate the washers when the washer reservoir is empty. This may cause the washer pump to overheat.



E169316

To operate the washers and spray the windshield, pull the lever toward you.

A wipe will occur a few seconds after washing to clear any remaining washer fluid. This feature can be switched on or off in the information display. See (page 109).

# Lighting

## LIGHTING CONTROL



E142449

- A Off
- B Parking lamps, instrument panel lamps, license plate lamps and tail lamps
- C Headlamps

## High Beams



E162679

- Push the lever forward to switch the high beams on.
- Push the lever forward again or pull the lever toward you to switch the high beams off.

## Headlamp Flasher



E162680

- Pull the lever toward you slightly and release it to flash the headlamps.

# Lighting

## AUTOLAMPS (If Equipped)

### WARNING

 The daytime running lamps system does not activate the tail lamps and may not provide adequate lighting during low visibility driving conditions. Also, the autolamps switch position may not activate the headlamps in all low visibility conditions, such as daytime fog. Always ensure that your headlamps are switched to auto or on, as appropriate, during all low visibility conditions. Failure to do so may result in a collision.



When the lighting control is in the autolamps position, the headlamps automatically turn on in low light situations or when the wipers activate.

If equipped, the following also activate when the lighting control is in the autolamps position and you switch them on in the information display:

- Configurable daytime running lamps.
- Automatic high beam control.
- Adaptive headlamp control.

The headlamps remain on for a period of time after you switch the ignition off. Use the information display controls to adjust the period of time that the headlamps remain on. See **Information Displays** (page 109).

**Note:** With the headlamps in the autolamps position, you cannot switch the high beam headlamps on until the autolamps system turns the low beam headlamps on.

## Windshield Wiper Activated Headlamps

The windshield wiper activated headlamps turn on within 10 seconds when you switch the windshield wipers on and the lighting control is in the autolamps position. They turn off approximately 60 seconds after you switch the windshield wipers off.

The headlamps will not turn on by wiper activation:

- During a mist wipe.
- When the wipers are on to clear washer fluid during a wash condition.
- If the wipers are in intermittent mode.

**Note:** If you switch autolamps and autowipers on, the headlamps will automatically turn on when the windshield wipers continuously operate.

## INSTRUMENT LIGHTING DIMMER

**Note:** If you disconnect and connect the battery, or fully discharge and charge the battery, the illuminated components will switch to the maximum setting.

E142451

# Lighting

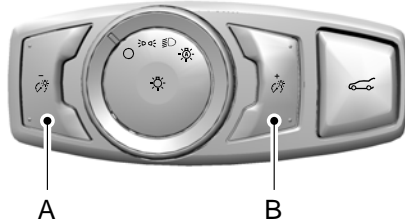

E165337

- A Press repeatedly or press and hold to dim.
- B Press repeatedly or press and hold to brighten.

## HEADLAMP EXIT DELAY

After you switch the ignition off, you can switch the headlamps on by pulling the direction indicator lever toward you. You will hear a short tone. The headlamps will switch off automatically after three minutes with any door open or 30 seconds after the last door has been closed. You can cancel this feature by pulling the direction indicator toward you again or switching the ignition on.

## DAYTIME RUNNING LAMPS (If

Equipped)

### WARNING



The daytime running lamps system does not activate the tail lamps and may not provide adequate lighting during low visibility driving conditions. Also, the autolamps switch position may not activate the headlamps in all low visibility conditions, such as daytime fog. Always ensure that your headlamps are switched to auto or on, as appropriate, during all low visibility conditions. Failure to do so may result in a collision.

### Type 1 - Conventional (Non-Configurable)

When you switch the ignition to the on position and the lighting control is in the off, autolamps or parking lamp position, the daytime running lamps will turn on whenever the headlamps are off. They turn off only when the headlamps are on.

# Lighting

---

## Type 2 - Configurable

**Note:** *If this type is equipped, you are able to switch the daytime running lamps on or off using the information display controls. See **Information Displays** (page 109).*

When the daytime running lamps are switched on in the information display and you switch the ignition to the on position with the lighting control in the autolamps position, the daytime running lamps turn on whenever the headlamps are off.

The other lighting control switch positions do not activate the daytime running lamps and can be used to temporarily override autolamp control.

When switched off in the information display, the daytime running lamps are off in all lighting control switch positions.

## AUTOMATIC HIGH BEAM CONTROL (If Equipped)

The system will automatically turn on your high beams if it is dark enough and no other traffic is present. When it detects the headlights of an approaching vehicle, the tail lamps of the preceding vehicle or street lighting, the system will turn off the high beams before they distract other drivers. The low beams remain on.

**Note:** *If it appears that automatic control of the high beams is not functioning properly, check the windshield in front of the camera for a blockage. A clear view of the road is required for proper system operation. Have any windshield damage in the area of the camera's field-of-view repaired.*

**Note:** *If the system detects a blockage such as bird droppings, bug splatter, snow or ice, and you do not observe changes, the system will go into low beam mode until you clear the blockage. A message may also appear in the instrument cluster display noting the front camera is blocked.*

**Note:** *Typical road dust, dirt and water spots will not affect the performance of the automatic high beam system. However, in cold or inclement weather conditions, you will notice a decrease in the availability of the high beam system, especially at start up. If you want to change the beam state independently of the system, you may switch the high beams on or off using the multifunction switch. Automatic control will resume when conditions are correct.*

**Note:** *Modification of the vehicle ride height such as using much larger tires, may degrade feature performance.*

A camera sensor, centrally mounted behind the windshield of your vehicle, continuously monitors conditions to decide when to switch the high beams off and on.

Once the system is active, the high beams will switch on if:

- the ambient light level is low enough
- there is no traffic in front of the vehicle
- the vehicle speed is greater than 25 mph (40 km/h)

# Lighting

The high beams will switch off if:

- the system detects the headlamps of an approaching vehicle or the tail lamps of a preceding vehicle.
- vehicle speed falls below 16 mph (25 km/h)
- the ambient light level is high enough that high beams are not required
- the system detects severe rain, snow or fog
- the camera is blocked

## Activating the System

Switch on the system using the information display and autolamps. See **Information Displays** (page 109). See **Autolamps** (page 86).



E142451

Switch the lighting control to the autolamps position.

## Manually Overriding the System

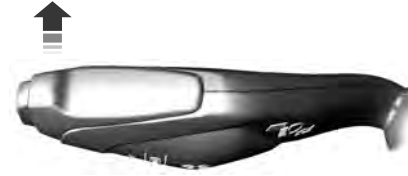

E169254

When the automatic control has activated the high beams, pushing or pulling the stalk will provide a temporary override to low beam.

Use the information display menu to permanently deactivate the system, or turn the lighting control switch from autolamps to headlamps.

## ADAPTIVE HEADLAMPS

The headlamp beams move in the same direction as the steering wheel. This provides more visibility when driving around curves.

- A. Without adaptive headlamps
- B. With adaptive headlamps

# Lighting

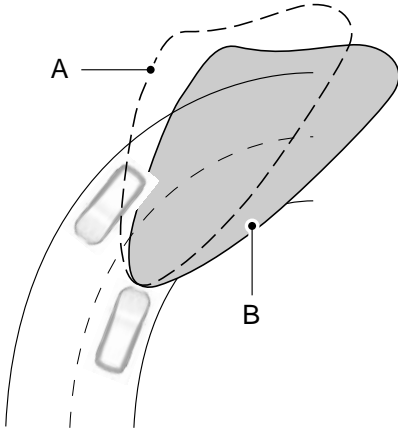

E161714

The system will only work with the lighting control switch in the autolamp position.



E142451

**Note:** There is a delay of two to five seconds before the system will operate when the vehicle is driven.

**Note:** The system is only active at speeds above 3 mph (5 km/h).

The system has a power-up movement check feature. When the vehicle is started, the lamps track left to right, then back to center to alert the driver that the system is working properly.

## DIRECTION INDICATORS



E162681

Push the lever up or down to use the direction indicators.

**Note:** Tap the lever up or down to make the direction indicators flash three times to indicate a lane change.

## INTERIOR LAMPS

The lamps switch on when:

# Lighting

- You open any door.
- You press a remote control button.
- You press switch A on the front interior lamp.

## Front Interior Lamp

**Note:** The front interior lamp switches are on the overhead console. The exact location of each switch on the overhead console depends upon which roof, sunroof, and window shade features are on your vehicle.

**Note:** Press switch B to switch the door function off when you open any door. The indicator lamp illuminates amber when the door function is off. When the door function is off and you open a door, the courtesy and door lamps stay off. Press switch B again to switch the door function back on. The indicator lamp illuminates white when the door function is on. When the door function is on and you open a door, the courtesy and door lamps switch on.

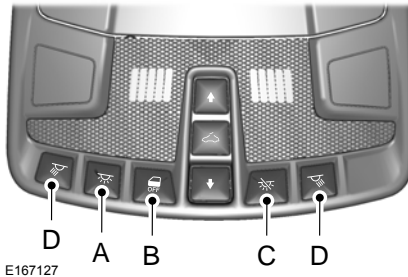

E167127

- A All lamps on switch.
- B Door function switch.
- C All lamps off switch.
- D Map lamp switches.

## Rear Interior Lamp

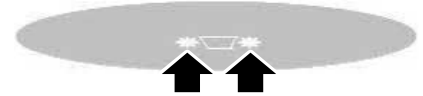

E150100

The rear interior lamps are hidden in the headliner. You can switch individual rear interior lamps on independently by waving your hand near the small white light in the headliner.

# Lighting

---

## Rear Interior Lamp (If Equipped)

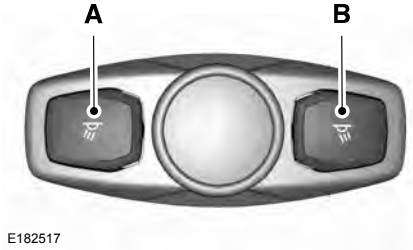

E182517

- A. Left-hand side map lamp.
- B. Right-hand side map lamp.

You can switch the lamps on individually by pressing the buttons.

# Windows and Mirrors

## POWER WINDOWS

### WARNINGS

 Do not leave children unattended in your vehicle and do not let them play with the power windows. They may seriously injure themselves.

 When closing the power windows, you should verify they are free of obstructions and make sure that children and pets are not in the proximity of the window openings.

**Note:** Window operation may stop or delay during low battery conditions and engine re-cranking. It will resume after the engine starts.

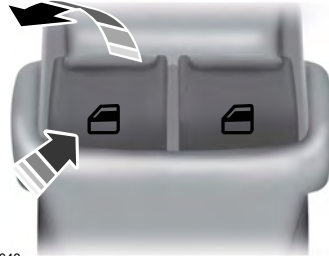

E146043

**Note:** You may hear a pulsing noise when just one of the windows are open. Lower the opposite window slightly to reduce this noise.

Press the switch to open the window.

Lift the switch to close the window.

### One-Touch Down

Press the switch fully and release it. Press again or lift it to stop the window.

### One-Touch Up

Lift the switch fully and release it. Press or lift it again to stop the window.

## Bounce-Back

The window will stop automatically while closing. It will reverse some distance if there is an obstacle in the way.

## Overriding the Bounce-Back Feature

### WARNING

 When you override the bounce-back feature, the window will not reverse if it detects an obstacle. Take care when closing the windows to avoid personal injury or damage to your vehicle.

Pull up the window switch and hold within two seconds of the window reaching the bounce-back position. The window will travel up with no bounce-back protection. The window will stop if you release the switch before the window closes fully.

# Windows and Mirrors

## Window Lock



E144072

Press the control to lock or unlock the rear window controls. It will illuminate when you lock the rear window controls.

## Accessory Delay

You can use the window switches for several minutes after you switch the ignition off or until you open either front door.

## GLOBAL OPENING AND CLOSING

You can use the remote control to operate the windows with the ignition off.

**Note:** You can enable or disable this feature in the information display or see an authorized dealer. See (page 109).

**Note:** To operate this feature, accessory delay must not be active.

## Opening the Windows

You can only open the windows for a short time after you unlock your vehicle with the remote control. After you unlock your vehicle, press and hold the remote control unlock button to open the windows and vent the moonroof. Release the button once movement starts. Press the lock or unlock button to stop movement.

## Closing the Windows

### WARNING



When closing the windows and moonroof, you should verify they are free of obstructions and make sure that children and pets are not in the proximity of the window openings.

To close the windows and moonroof, press and hold the remote control lock button. Release the button once movement starts. Press the lock or unlock button to stop movement.

## EXTERIOR MIRRORS

### Power Exterior Mirrors

#### WARNING



Do not adjust the mirrors when your vehicle is moving.

# Windows and Mirrors



E144073

- A Left-hand mirror.
- B Adjustment control.
- C Right-hand mirror.

To adjust a mirror:

1. Select the mirror you want to adjust. The control illuminates.
2. Adjust the position of the mirror.
3. Press the mirror switch again.

## Fold-Away Exterior Mirrors

Push the mirror toward the door window glass. Make sure that you fully engage the mirror in its support when returning the mirror to its original position.

## Power-Folding Mirrors (If Equipped)

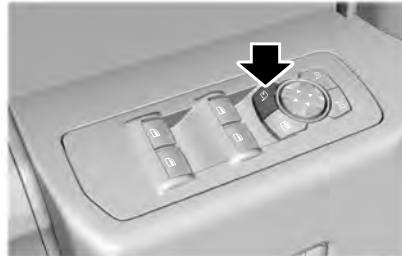

E176218

To fold both mirrors, make sure you switch your vehicle on (with the ignition in accessory mode or the engine running) and then:

1. Press the control to fold the mirrors.
2. Press the control again to unfold.

**Note:** Once you press the control, you cannot stop the mirrors midway through their movement. Wait until the mirrors stop moving and press the control again.

## Heated Exterior Mirrors

See **Heated Windows and Mirrors** (page 142).

## Memory Mirrors

You can save and recall the mirror positions through the memory function. See **Memory Function** (page 149).

## Auto-Dimming Feature (If Equipped)

The driver exterior mirror automatically dims when the interior auto-dimming mirror turns on.

## Signal Indicator Mirrors

The outer portion of the appropriate mirror housing blinks when you switch on the direction indicator.

# Windows and Mirrors

## Integrated Blind Spot Mirrors (If Equipped)

### WARNING

 Objects in the blind spot mirror are closer than they appear.

Blind spot mirrors have an integrated convex mirror built into the upper outboard corner of the exterior mirrors. Their design can increase your visibility along the side of your vehicle.

Check the main mirror first before a lane change, then check the blind spot mirror. If no vehicles are present in the blind spot mirror and the traffic in the adjacent lane is at a safe distance, signal that you intend to change lanes. Glance over your shoulder to verify traffic is clear and carefully change lanes.

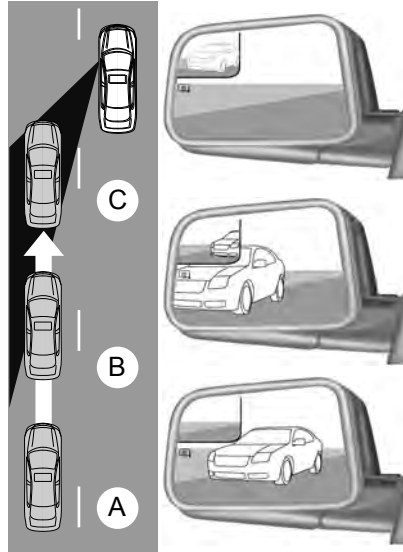

E138665

The image of the approaching vehicle is small and near the inboard edge of the main mirror when it is at a distance. The image becomes larger and begins to move outboard across the main mirror as the vehicle approaches (A). The image transitions from the main mirror and begins to appear in the blind spot mirror as the vehicle approaches (B). The vehicle transitions to your peripheral field of view as it leaves the blind spot mirror (C).

## Blind Spot Monitor (If Equipped)

See **Blind Spot Information System** (page 227).

## INTERIOR MIRROR

### WARNING

 Do not adjust the mirror when your vehicle is moving.

**Note:** Do not clean the housing or glass of any mirror with harsh abrasives, fuel or other petroleum or ammonia-based cleaning products.

# Windows and Mirrors

You can adjust the interior mirror to your preference. Some mirrors also have a second pivot point. This lets you move the mirror head up or down and from side to side.

## Auto-Dimming Mirror

**Note:** Do not block the sensors on the front and back of the mirror. Mirror performance may be affected. A rear center passenger or raised rear center head restraint may also block light from reaching the sensor.

The mirror will dim automatically to reduce glare when bright lights are detected from behind your vehicle. It will automatically return to normal reflection when you select reverse gear to make sure you have a clear view when backing up.

## SUN VISORS

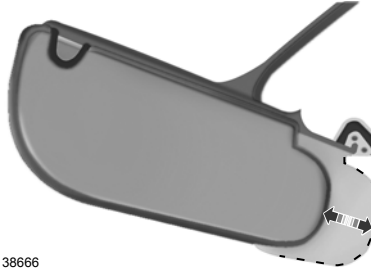

E138666

Rotate the sun visor toward the side window and extend it rearward for extra shade.

## Illuminated Vanity Mirror

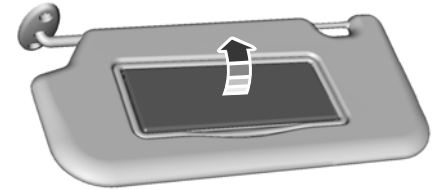

E162197

Lift the cover to switch the lamp on.

## SUN SHADES (If Equipped)

**Note:** Do not try to move the sun shade manually.

The power rear sun shade covers the rear window of the vehicle.

# Windows and Mirrors



E145986

The control is in the overhead console.

The sun shade has a one-touch up and down feature. Press and release the control to move the sun shade. To stop motion, press the control a second time.

The sun shade automatically retracts when you shift the transmission into **R** (Reverse).

## MOONROOF (If Equipped)

### WARNINGS

 Do not let children play with the moonroof or leave them unattended in the vehicle. They may seriously hurt themselves.

### WARNINGS

 When closing the moonroof, you should verify that it is free of obstructions and make sure that children and pets are not in the proximity of the roof opening.

You can open the sliding shade manually when the moonroof is in its closed position. Pull the shade toward the front of the vehicle to close it.

The moonroof controls are on the overhead console and have a one-touch open and close feature. To stop the motion during a one-touch operation, touch the control a second time.

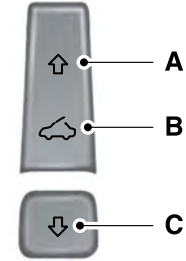

E144499

- A Open
- B Vent
- C Close

## Opening and Closing the Moonroof

Touch (A) to open the moonroof. It will stop short of the fully opened position.

**Note:** *This position helps to reduce wind noise or rumbling which may happen with the moonroof fully open. Touch (A) again to fully open the moonroof.*

Touch (C) to close the moonroof.

# Windows and Mirrors

## Bounce-Back

The moonroof will stop automatically and reverse some distance if an obstacle is detected while closing.

Touch and hold (C) within two seconds of a bounce-back event to override this function.

## Venting the Moonroof

Touch (B) to vent the moonroof. Touch (C) to close it.

## Retractable Panoramic Roof (If Equipped)

The moonroof controls on the overhead console operate the same except the moonroof will open fully when you touch the open control.

## Automatic Glass Movement

When the retractable panoramic roof is open, it will automatically move to a position less than full open under certain vehicle conditions. This helps to reduce wind noise. If the glass is between this position and full open and your vehicle reaches a high speed, the glass will automatically move to the defined position.

You can override automatic movement by touching the moonroof open or close control. The feature will remain overridden until you switch the ignition off and then back on.

## Power Sunscreen

The power sunscreen covers the panoramic roof glass. The sunscreen control is in the overhead console.



E173113

The sunscreen has a one-touch open and close feature. Push the control to move the sunscreen. To stop motion, press the control a second time.

The sunscreen must be open before opening the moonroof. If you press the control while the sunscreen is in its closed position, the sunscreen will open first followed by the moonroof. If both the sunscreen and moonroof are open and you touch the moonroof close control, the moonroof will close first followed by the sunscreen.

# Instrument Cluster

---

## GAUGES

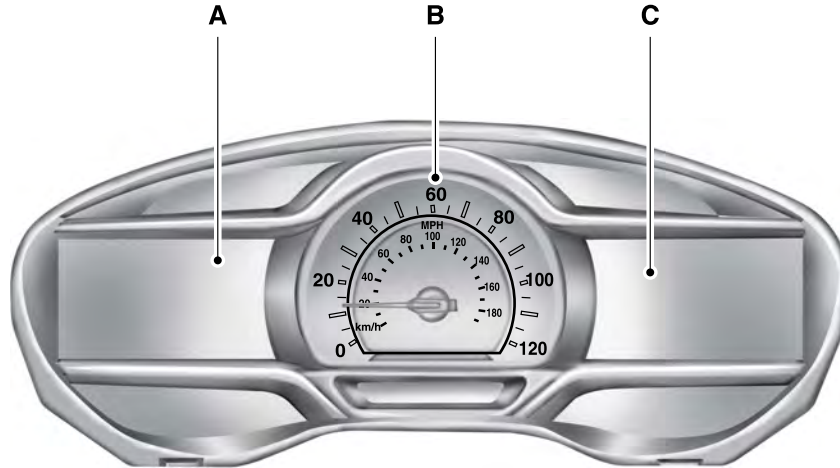

E151261

# Instrument Cluster

---

- A Left Information Display
- B Speedometer
- C Right Information Display

## Left Information Display

### Odometer

Located in the bottom of the display. It registers the accumulated distance your vehicle has traveled.

### Battery Gauge

The high voltage battery gauge provides Charge Fill (State of Charge), Charge Assist, and Regen Active information.

### Charge Fill

The fill level, or State of Charge indicates the amount of energy stored in the high-voltage battery as a percent of total energy capacity. The level will increase or decrease as the battery charges and discharges during normal operation.

### Charge Assist

The up and down arrows provide information about the energy going into and out of the high-voltage battery. The up arrow above the battery indicates battery charging such as from regenerative braking. The down arrow below the battery indicates battery discharging to provide power for propulsion or vehicle accessories.

This feature can be switched on or off in the information displays settings menu. See **General Information** (page 109).

### Regen Active

A circular arrow symbol appears in the center of the battery gauge when energy is being recaptured through the regenerative braking system.

This feature can be switched on or off in the information displays settings menu. See **General Information** (page 109).

### Fuel Gauge

**Note:** *The fuel gauge may vary slightly when your vehicle is moving or on a gradient.*

Switch the ignition on. The fuel gauge will indicate approximately how much fuel is left in the fuel tank. The arrow adjacent to the fuel pump symbol indicates on which side of your vehicle the fuel filler door is located.

The needle should move toward F when you refuel your vehicle. If the needle points to E after adding fuel, this indicates your vehicle needs service soon.

After refueling some variability in needle position is normal:

# Instrument Cluster

- It may take a short time for the needle to reach F after leaving the gas station. This is normal and depends upon the slope of pavement at the gas station.
- The fuel amount dispensed into the tank is a little less or more than the gauge indicated. This is normal and depends upon the slope of pavement at the gas station.
- If the gas station nozzle shuts off before the tank is full, try a different gas pump nozzle.

## **Low Fuel Reminder**

A low fuel reminder triggers when the fuel gauge needle is at 1/16th.

## **Variations:**

<b>Driving type (fuel economy conditions)</b>	<b>Fuel gauge position</b>	<b>Distance-to-empty</b>
Highway driving	1/16th	35 miles to 80 miles (56 km to 129 km)
Severe duty driving (trailer towing, extended idle)	1/16th	35 miles (56km)

## **Vehicle Settings and Personalization**

### **Display/Trip**

See (page 109).

### **Information**

See (page 109).

### **Settings**

See (page 109).

## **Brake Coach Display**

The Brake Coach appears after your vehicle has come to a stop. It coaches you to brake in a manner which maximizes the amount of energy returned through the regenerative braking system. The percent displayed is an indication of the regenerative braking efficiency with 100% representing the maximum amount of energy recovery.

This feature can be switched on or off in the information displays settings menu. See **General Information** (page 109).

# Instrument Cluster

## Trip Summary

Trip Summary displays upon shutting off your vehicle. The information is cumulative over the last trip. A new trip begins each time you start your vehicle (when the Ready to Drive message comes on). Corresponding trip efficiency leaves appear on the right information display.

- Distance - Displays the total distance traveled, distance traveled on battery power only (EV distance) and Regen distance. Regen distance is the estimated range gained from energy recaptured through regenerative braking.
- Energy Use - Displays the average fuel economy.
- Brake Score - The percent displayed is an indication of the regenerative braking efficiency for the trip.

## Right Information Display

### Entertainment

See **General Information** (page 359).

### Phone

See **General Information** (page 359).

### Navigation or Compass

See **General Information** (page 359).

### Fuel Economy

See (page 109).

### Vehicle Range

Located at the bottom of the display. It indicates the estimated distance to empty based on the fuel remaining in the tank. Changes in your driving pattern and climate control use may cause the value to vary.

### Trip Efficiency Leaves

Trip Efficiency Leaves display upon shutting off your vehicle. The number of leaves represent the average for the last trip. A new trip begins each time you start your vehicle (when the Ready to Drive message comes on). Corresponding Trip Summary data displays on the left information display.

## WARNING LAMPS AND INDICATORS

The following warning lamps and indicators will alert you to a vehicle condition that may become serious. Some lamps light when you start your vehicle to make sure they work. If any lamps remain on after starting your vehicle, refer to the respective system warning lamp for further information.

**Note:** *Some warning indicators appear in the information display and function the same as a warning lamp but do not light when you start your vehicle.*

### Adaptive Cruise Control (If Equipped)



The speed control system indicator light changes color to indicate what mode the system is in: See

**Using Adaptive Cruise Control** (page 213).

On (white light): Lights when you turn the adaptive cruise control system on. Turns off when you turn the speed control system off.

# Instrument Cluster

Engaged (green light): Lights when the adaptive cruise control system engages. Turns off when the speed control system disengages.

## Anti-Lock Braking System



If it lights when you are driving, this indicates a malfunction. You will continue to have the normal braking system (without Anti-lock braking system) unless the brake system warning lamp also lights. Have an authorized dealer check the system.

## Battery



If it lights while driving, it indicates a malfunction. Switch off all unnecessary electrical equipment and have an authorized dealer check the system immediately.

## Blind Spot Monitor (If Equipped)



Lights when you switch this feature off or with a blind spot message. See **Blind Spot Information System** (page 227). See **Information Messages** (page 120).

## Brake System



Lights when you engage the parking brake with the ignition on. If it lights when you are driving, check that the parking brake is not on. If the parking brake is not on, this Brake System lamp indicates low brake fluid level or a brake system malfunction. Have an authorized dealer check the system immediately.

## WARNING



Driving your vehicle with the warning lamp on is dangerous. A significant decrease in braking performance may occur. It will take you longer to stop your vehicle. Have an authorized dealer check the system immediately. Driving extended distances with the parking brake engaged can cause brake failure and the risk of personal injury.

## Cruise Control (If Equipped)



Lights when you switch on cruise control.

## Direction Indicator



Lights when the left or right turn signal or the hazard warning flasher is switched on. If the indicators stay on or flash faster, check for a burned-out bulb. See **Changing a Bulb** (page 299).

# Instrument Cluster

## Door Ajar



Lights when the ignition is on and any door is not completely closed.

## Electric Park Brake



Lights or flashes when the electric parking brake malfunctions.

## Engine or Motor Coolant Temperature



Lights when the engine or motor cooling system is overheating.

Stop your vehicle in a safe place and have an authorized dealer check the system.

## Engine Oil



If it lights with the engine running or when you are driving, this indicates a malfunction. Stop your vehicle as soon as it is safe to do so and switch the engine off. Check the engine oil level. See **Engine Oil Check** (page 288).

**Note:** Do not resume your trip if it lights, even if the oil level is correct. Have an authorized dealer check the system immediately.

## Fasten Safety Belt



Lights and a chime sounds to remind you to fasten your safety belt. See **Safety Belt Minder** (page

38).

## Front Airbag



Lights when you start your vehicle. If it continues to flash or remains on, it indicates a malfunction. Have an authorized dealer check the system.

## Grade Assist (If Equipped)



Lights when you switch on the grade assist function.

## Heads Up Display (If Equipped)



A red beam of lights appears on the windshield in certain instances when using adaptive cruise control and/or the collision warning system. To make sure the display works, it will also appear momentarily when you start your vehicle .

## High Beam



Lights when you switch on the high-beam headlamps. Flashes when you use the headlamp flasher.

## Hood Ajar



Lights when the ignition is on and the hood is not completely closed.

## Lane Keeping Aid (If Equipped)



Lights when you activate the lane keeping system.

# Instrument Cluster

## Low Fuel Level



Lights when the fuel level is low or the fuel tank is nearly empty. Refuel as soon as possible.

## Low Tire Pressure Warning



Lights when your tire pressure is low. If the lamp remains on with the engine running or when driving, check your tire pressure as soon as possible.

To confirm the lamp is working, it will also light momentarily when you switch on the ignition. If it does not light when you switch the ignition on, or it begins to flash at any time, have an authorized dealer check the system.

## Low Washer Fluid



Lights when the windshield washer fluid is low.

## Parking Lamps



Lights when you switch on the parking lamps.

## Powertrain Fault



Lights when your vehicle detects a powertrain fault. Contact an authorized dealer as soon as possible.

**Note:** *If your vehicle detects certain faults, it will not allow you to operate the accelerator pedal. If this happens, press the brake pedal and release it. This will activate limp home vehicle operation. In limp home vehicle operation, your vehicle will accelerate in a controlled manner up to a maximum speed of 35 mph (56 km/h) on a flat surface. If you apply the brake pedal or move the transmission to neutral (N) you can override your vehicle's acceleration.*

## Ready to Drive



Lights when you switch on your vehicle and it is ready to drive. A corresponding message may display stating ready to drive.

## Service Engine Soon



If the service engine soon indicator light stays illuminated after the engine is started, it indicates that the On Board Diagnostics system (OBD) has detected a malfunction of the vehicle emissions control system. Refer to On board diagnostics (OBD) in the Fuel and Refueling chapter for more information about servicing your vehicle. See **Emission Control System** (page 181).

If the light is blinking, the engine is misfiring. This could damage your catalytic converter. Drive in a moderate fashion (avoid heavy acceleration and deceleration) and have your vehicle serviced immediately.

# Instrument Cluster

**Note:** *If your engine is misfiring, excessive exhaust temperatures could damage the catalytic converter or other vehicle components.*

The service engine soon indicator lights when the you first switch on your vehicle, prior to engine start, to check the bulb and to indicate whether the vehicle is ready for inspection maintenance testing.

Normally, the service engine soon light will stay on until the engine cranks, then turn itself off if no malfunctions are present. However, if after 15 seconds the service engine soon light blinks eight times, it means that the vehicle is not ready for inspection maintenance testing. See **Emission Control System** (page 181).

## Stability Control



Flashes when the system is active. If it stays lit or does not light when you switch on the ignition, this indicates a malfunction. During a malfunction the system will switch off. Have an authorized dealer check the system immediately. See **Using Stability Control** (page 200).

## Stability Control Off



Lights when you switch the system off. It will go out when you switch the system back on or when you switch off the ignition. See **Using Stability Control** (page 200).

## Stop Safely



Lights if your vehicle has an electrical component fault or failure that will cause your vehicle to shutdown or enter into a limited operating mode. You may also see a message.

## Trunk Ajar



Lights when the ignition is on and the trunk is not completely closed.

## AUDIBLE WARNINGS AND INDICATORS

### Key in Ignition Warning Chime

Sounds when you open the driver's door and you have left the key in the ignition with it in the off or accessory position.

### Keyless Warning Alert (If Equipped)

Sounds the horn twice when you exit your vehicle with the intelligent access key, after the last door is closed and your keyless vehicle is in RUN, indicating your vehicle is still on.

### Headlamps On Warning Chime

Sounds when you remove the key from the ignition and open the driver's door and you have left the headlamps or parking lamps on.

# Instrument Cluster

---

## **Parking Brake On Warning Chime**

Sounds when you have left the parking brake on and drive your vehicle. If the warning chime remains on after you have released the parking brake, have the system checked by an authorized dealer immediately.

# Information Displays

## GENERAL INFORMATION

### WARNING



Driving while distracted can result in loss of vehicle control, crash and injury. We strongly recommend that you use extreme caution when using any device that may take your focus off the road. Your primary responsibility is the safe operation of your vehicle. We recommend against the use of any hand-held device while driving and encourage the use of voice-operated systems when possible. Make sure you are aware of all applicable local laws that may affect the use of electronic devices while driving

Various systems on your vehicle can be controlled using the information display controls on the steering wheel. Corresponding information displays in the information display.

## Left Information Display Controls

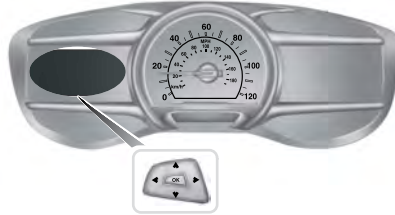

E146303

- Press the up and down arrow buttons to scroll through and highlight the options within a menu.
- Press the right arrow button to enter a sub-menu.
- Press the left arrow button to exit a menu.
- Press and hold the left arrow button at any time to return to the main menu display (escape button).
- Press the **OK** button to choose and confirm settings or messages.

## Main menu

From the main menu bar on the left side of the information display, you can choose from the following categories:



Display/Trip



Information



Settings

Scroll up or down to highlight one of the categories, and then press the right arrow key or **OK** to enter into that category. Press the left arrow key as needed to exit back to the main menu.

## Display/Trip



Use the up or down arrow buttons to choose between the following display options.

# Information Displays

**Note:** The cluster will remember the menu level 2 state when the individual key state is changed from the RUN position to the OFF position.

Display/Trip			
Menu level 2	Menu level 3	Menu level 4	Menu level 5
Engage Split Power + Avg Fuel Economy + Instantaneous Fuel Gauge + Battery Gauge + Fuel Gauge)	Help	—	—
Empower (Power with engine on/off threshold + Avg Fuel Economy + Instantaneous Fuel Gauge + Battery Gauge + Fuel Gauge)	Help	—	—
MyView (MyView + Battery Gauge + Fuel Gauge)	Change MyView	Avg Fuel	Avg Fuel
		Power	Inst. Fuel
		Split Power	Coolant Temp
		Power + Threshold	Accessory Power
		Tach rpm x 1000 + Avg Fuel	Trip 1
		Accessory Power	Trip 2

# Information Displays

Display/Trip			
		Trip 1	Fuel History
		Trip 2	Coach
		Fuel History	Average Speed
		Coach	Blank
		Blank	—
	Help	—	—
Trip 1 & 2: Trip Data + Battery Gauge + Fuel Gauge	Help	—	—

## Engage

Engage provides separate gauges for engine power and high voltage battery power in kilowatts (kW). The engine power gauge fill is white and the high voltage battery power gauge fill is blue. You can also see an instantaneous fuel economy gauge. When your vehicle is operating on battery power only, you will see EV displayed and the gauges will appear in blue.

**Note:** Hold **OK** to reset average fuel economy.

## Empower

Empower provides a power demand gauge in kilowatts (kW) which includes an engine on or off threshold.

- When your vehicle is operating with battery power only (below the threshold), you will see EV displayed and the gauge fill is blue.
- When your vehicle is operating with both the engine and the high voltage battery providing power the gauge fill is white.

# Information Displays

- When power demand surpasses the amber indicator, this level of demand and associated fuel economy displays in amber.
- When the engine is on, reducing power demand to less than the threshold will allow the engine to turn off.

You can also see an instantaneous fuel economy gauge.

**Note:** Hold **OK** to reset average fuel economy.

## MyView

You can choose what to display in this view. Selecting **Change MyView** in the options menu allows you to scroll through two columns of content choices.

- Press the up or down arrow to view content.
- Press OK to save your selected content
- You must select content in both columns before you can save your new MyView.

Unique content available in MyView:

- **Accessory Power**— Indicates electrical power demands from your vehicle's accessory systems. Accessories use power but do not contribute to propelling your vehicle. The gauge separately displays power demand in kilowatts (kW) for climate and other accessories.
  - Climate includes the power being used by high voltage climate control components such as the electric A/C compressor.
  - Other includes all power being used by the low voltage accessories (cabin fans, headlights and heated seats).
- **Coolant Temp** – Indicates engine coolant temperature. At normal operating temperature, the level indicator will be white and will be in the normal range (between H and C). If the engine coolant temperature exceeds the normal range, the level indicator will change to red to indicate that the engine is overheating. Stop your vehicle as soon as safely possible, turn your vehicle off and let the engine cool.

- **Tach rpm x 1000** — When the gasoline engine is running, the tachometer gauge displays the engine speed in revolutions per minute (RPM). When your vehicle is operating on battery power only with the engine off, EV displays and the tachometer is greyed out.

**Note:** The trip data, and average fuel economy cannot be reset in MyView.

## Trip 1 & 2

Provides trip odometer, trip average fuel economy and trip timer.

Distance traveled on battery power only with the engine off is shown in blue next to total trip distance.

## Information



In this mode, you can view different vehicle system information and perform a system check.

# Information Displays

Information		
Warnings	Tutorial	Displays a number of different system tutorials. Use the up or down arrows to scroll through the tutorials. Then press <b>OK</b> to view.
	Driver Alert	Displays the associated driver alert graphic.
	MyKey	MyKeys (Number of MyKeys programmed)
		MyKey Miles (km) (Distance traveled using a programmed MyKey)
		Admin Keys (Number of admin keys)
System Check	All active warnings will display first if applicable. The system check menu may appear different based upon equipment options and current vehicle status. Use the up or down arrow buttons to scroll through the list.	

## Settings



In this mode, you can configure different driver setting choices.

**Note:** Some items are optional and may not appear.

**Note:** Some MyKey items will only appear if a MyKey is set.

# Information Displays

Settings				
Menu level 2	Menu level 3	Menu level 4	Menu level 5	Menu level 6
Driver Assist	Traction Ctrl	On or Off	—	
	Drive Control	Sport, Normal or Comfort	—	
	Blindspot	On or Off	—	
	Pre-Collision	Alert Sensitivity	High, Normal or Low	
		Active Braking	On or Off	
	Cross Traffic	On or Off	—	
	Cruise Control	Adaptive or Normal	—	
	ECO Cruise	On or Off	—	
	Driver Alert	On or Off	—	
	Lane keeping Sys	Mode	Alert only or Alert + Aid	
		Intensity	High, Normal or Low	
	EV + Mode	On or Off	—	
	Front Park Aid	On or Off	—	
Rear Park Aid	On or Off	—		

# Information Displays

Settings					
Vehicle	Auto Engine Off	On or Off	—		
	Easy Entry / Exit	On or Off	—		
	Lighting	Adaptive Hdlamps	Traffic Set Up	Right or Left Hand Traffic	
		Auto Highbeam	On or Off		
		Daytime Lights	On or Off		
		Autolamp Delay	Select time interval		
	Locks	Autolock	On or Off		
		Autounlock	On or Off		
		Mislock	On or Off		
		Remote Unlocking	All doors or Driver door		
	Neutral Tow	Hold <b>OK</b> to Initialize			
	Oil Life Reset	Set to XXX % - Hold <b>OK</b> to Reset			
	Power Decklid	Enable or Disable Switch			
	Remote Start	Climate Control	Heater – A/C	Auto or Last Settings	
			Steering Wheel	Auto or Off	
Front Defrost			Auto or Off		

# Information Displays

Settings				
			Rear Defrost	Auto or Off
			Driver Seat	Auto or Off
			Passenger Seat	Auto or Off
		Duration	5, 10 or 15 minutes	
		Quiet Start	On or Off	
		System	Enable or Disable	
	Switch Inhibit	On or Off		
	Tire Mobility Kit	Select number of years		
	Windows	Remote Open	On or Off	
		Remote Close	On or Off	
	Wipers	Courtesy Wipe	On or Off	
		Rain Sensing	On or Off	
	MyKey	Create MyKey	Hold <b>OK</b> to Create MyKey	
911 Assist		Always On or User Selectable		
Traction Control		Always On or User Selectable		
Max Speed		Choose desired speed or off		

# Information Displays

Settings			
	Speed Minder	Choose desired speed or off	
	Volume Limiter	On or Off	
	Do Not Disturb	On or Off	
	Clear MyKeys	Hold <b>OK</b> to Clear All MyKeys	
Display	Language	Select the desired language - Hold OK to Set	
	Units	Distance	Miles & GAL, l/100km or km/l
		Temperature	Fahrenheit (°F) or Celsius (°C)
	Brake Coach	On or Off	
	Regen Active	On or Off	
	Charge Assist	On or Off	
	Driving History	Hold <b>OK</b> to Reset	

# Information Displays

## Right Information Display Controls



- Press the up and down arrow buttons to scroll through and highlight the options within a menu.
- Press the right arrow button to enter a sub-menu.
- Press the left arrow button to exit a menu.
- Press the **OK** button to choose and confirm your selection.

### Main menu

From the main menu bar on the right side of the information display, you can choose from the following categories:

### Entertainment

See **General Information** (page 359).

### Phone

See **General Information** (page 359).

### Navigation or Compass

See **General Information** (page 359).

### Fuel Economy

Use the up or down arrow buttons to choose between the following display options.

E179397

**Note:** The information display will remember the menu level 2 state when you change the individual key state from the RUN to the OFF position.

Fuel Economy			
Menu level 2	Menu level 3	Menu level 4	Menu level 5
Efficiency Leaves	Flowers	—	—
	Help	—	—

# Information Displays

Fuel Economy			
Fuel History (Instantaneous Fuel Economy + Fuel Economy History + Avg Fuel Economy)	Duration	5, 10 or 30 minutes	—
	Help	—	—
Coach	Help	—	—

## Efficiency Leaves

Efficiency leaves indicate short term driving efficiency measured over the last few minutes. The more leaves and vines that appear on the display, the better your fuel economy. Leaves and vines will occasionally appear and disappear to indicate a change in your driving efficiency.

Flowers appear on the efficiency leaves screen in addition to the leaves and vines. The flowers indicate long term driving efficiency. The more flowers that appear on the display, the more efficiently you have driven. Once earned, the flowers will remain unless reset, unlike the leaves, which come and go as your short term fuel economy changes.

This feature can be reset in the information displays settings menu under Driving History. See **General Information** (page 109).

## Fuel History

From left to right this view includes an instantaneous fuel economy gauge, historical fuel economy data and average fuel economy. The historical data represents an average over time intervals of either 1, 2 or 6 minutes, with the leftmost interval being the most recent. Shown at the bottom of the view is the total time duration for the 5 intervals. You can select total duration in the options menu. Intervals shown in grey color are from the previous drive. The blue horizontal line represents the average fuel economy value shown to the right.

**Note:** Hold **OK** to reset average fuel economy.

## Coach

This view provides a comparison of your recent acceleration, braking and cruising behavior, then recommends the most efficient use of energy under present conditions. The horizontal bars fill from left to right with best behavior and appear blue when at least half full. When the bars are less than half full, the color is amber, suggesting that you need a change in your driving behavior to achieve better energy efficiency.

**Note:** Fuel Economy will be impacted by your use of brakes, accelerator and accessories, as well as environmental conditions such as hills and weather.

# Information Displays

**Note:** Fuel economy is not always a measure of appropriate driving behavior. For example, when driving uphill and maintaining an appropriate speed, your instant fuel economy may not be good (losing leaves) but the Coach may show a blue bar for Acceleration and Cruising.

## Common Displays

Both Average fuel economy and an instantaneous fuel economy gauge are included in Engage, Empower and MyView (if selected) on the left information display. They are also included in Fuel History on the right information display.

## Average Fuel Economy

Average Fuel Economy is continuously averaged since the last reset. You can reset your average fuel economy by pressing and holding the **OK** button on the corresponding steering wheel controls.

**Note:** Average fuel economy cannot be reset in MyView.

## Instantaneous Fuel Economy

If your instantaneous fuel economy is greater than the maximum value displayed, a + sign will be shown next to the maximum scale number. When your vehicle is operating on battery power only, EV will display and the gauge fill will show in blue.

## INFORMATION MESSAGES

**Note:** Depending on the vehicle options equipped with your vehicle, not all of the messages will display or be available. Certain messages may be abbreviated or shortened depending upon which cluster type you have.



E145981

Press the OK button to acknowledge and remove some messages from the information display. Other messages will be removed automatically after a short time.

Certain messages need to be confirmed before you can access the menus.

# Information Displays

## Active Park

Message	Action
Active Park Fault	Displayed when the system needs service. Contact your authorized dealer as soon as possible.

## Adaptive Cruise Control

Message	Action
Adaptive Cruise Malfunction	Displayed when a radar malfunction is preventing the ACC from engaging. See <b>Using Adaptive Cruise Control</b> (page 213).
Adaptive Cruise Not Available	Displayed when conditions exist such that the adaptive cruise cannot function properly. See <b>Using Adaptive Cruise Control</b> (page 213).
Adaptive Cruise Not Available Sensor Blocked See Manual	Displayed when the radar is blocked because of poor radar visibility due to bad weather or ice/mud/water in front of radar. Driver can typically clean the sensor to resolve. See <b>Using Adaptive Cruise Control</b> (page 213).
Cruise Control Automatic Braking Turned Off	Displayed when the automatic braking has been disabled.
Front Sensor Not Aligned	Displayed when a radar malfunction is preventing the ACC from engaging.

# Information Displays

Message	Action
Adaptive Cruise - Driver Resume Control	Displayed when the adaptive cruise has reinstated controls to the driver.
Adaptive Cruise Speed Too Low to Activate	Displays when the vehicle speed is too slow to activate the adaptive cruise.
Adaptive Cruise Shift Down	Displays when the vehicle speed is getting too low for adaptive cruise.

## AdvanceTrac™

Message	Action
Service AdvanceTrac	Displays when the system detects a malfunction due to a blocked sensor.
AdvanceTrac Off On	Displayed when the traction control has been disabled or enabled by the driver.

## Airbag

Message	Action
Occupant Sensor BLOCKED Remove Objects Near Passenger Seat	Displays when the system detects a malfunction due to a blocked sensor.

# Information Displays

---

## Alarm

Message	Action
Vehicle Alarm to Stop Alarm, Start Vehicle	Displays when the alarm has been triggered due to unauthorized entry. See <b>Anti-Theft Alarm</b> (page 76).

## Automatic Engine Shutdown

Message	Action
Engine Shuts Off in XX Seconds	Displays when the engine is getting ready to shut off.
Engine Shut Off for Fuel Economy	Displays when the engine has shut off to help increase fuel economy.
Engine Shuts Off in XX Seconds Press Ok to Override	Displays when the engine is getting ready to shut off. You can press OK on the left steering wheel button to override the shut down.

# Information Displays

## Battery and Charging System (12 volt)

Message	Action
Check Charging System	Displayed when the charging system needs servicing. If the warning stays on or continues to come on, contact your authorized dealer as soon as possible.
Low Battery Features Temporarily Turned Off	Displayed when the battery management system detects an extended low-voltage condition. Various vehicle features will be disabled to help preserve the battery. Turn off as many of the electrical loads as soon as possible to improve system voltage. If the system voltage has recovered, the disabled features will operate again as normal
Turn Power Off to Save Battery	Displayed when the battery management system determines that the battery is at a low state of charge. Turn the ignition off as soon as possible to protect the battery. This message will clear once the vehicle has been started and the battery state of charge has recovered. Turning off unnecessary electrical loads will allow faster battery state-of-charge recovery.

## Battery and Charging System (High Voltage)

Message	Action
Ready to Drive	Displays when the vehicle is ready to drive.

# Information Displays

## Blind Spot Information and Cross Traffic Alert System

Message	Action
Blindspot System Fault	Displayed when a fault with the system has occurred. Contact your authorized dealer as soon as possible.
Blindspot Not Available Sensor Blocked See Manual	Displayed when the system sensors are blocked. Contact your authorized dealer as soon as possible. See <b>Blind Spot Information System</b> (page 227).
Cross Traffic Vehicle Coming From X	Displayed when the system detects a vehicle. See <b>Blind Spot Information System</b> (page 227).
Cross Traffic Not Available Sensor Blocked See Manual	Displayed when the system sensors are blocked. See <b>Blind Spot Information System</b> (page 227).
Cross Traffic System Fault	Displays when a fault with the system has occurred. Contact your authorized dealer as soon as possible.

## Doors and Locks

Message	Action
X Door Ajar	Displays when the door(s) listed is not completely closed and the vehicle is moving.
	Displays when the door(s) listed is not completely closed.
Trunk Ajar	Displays when the luggage compartment is not completely closed.
Hood ajar	Displays when the hood is not completely closed.

# Information Displays

Message	Action
Switches Inhibited Security Mode	Displays when the door switches have been disabled.
Child Lock Malfunction Service Required	Displays when there is a system malfunction with the child locks. Contact your authorized dealer as soon as possible.
Factory Keypad Code XXXXX	Displays the factory keypad code after the keypad has been reset. See <b>Keyless Entry</b> (page 70).

## Driver Alert

Message	Action
Driver Alert Warning Rest Now	Stop and rest as soon as it is safe to do so.
Driver Alert Warning Rest Suggested	Take a rest break soon.

## Fuel

Message	Action
Fuel Level Low	Displayed as an early reminder of a low fuel condition.
Check Fuel Fill Inlet	Displayed when the fuel fill inlet may not be properly closed.

# Information Displays

## Hill Start Assist

Message	Action
Hill Start Assist Not Available	Displays when hill start assist is not available. Contact your authorized dealer. See <b>Hill Start Assist</b> (page 195).

## Keys and Intelligent Access

Message	Action
Press Brake to START	Displayed as a reminder to press the brake while starting the vehicle.
No Key Detected	Displayed if the key is not detected by the system. See <b>Using Adaptive Cruise Control</b> (page 213).
Restart Now or Key is Needed	Displayed when the start/stop button is pressed to shut off the engine and an Intelligent Access key is not detected inside the vehicle.
Run Power Active	Displayed when the vehicle is in the run ignition state.
Starting System Fault	This message is displayed when there is a problem with your vehicle's starting system. See your authorized dealer for service.
Key Program Successful	Displayed during spare key programming, when an Intelligent Access key is programmed to the system.
Key Program Failure	Displayed during spare key programming, when an Intelligent Access key has failed to be programmed.

# Information Displays

Message	Action
Max Number of Keys Learned	Displayed during spare key programming when the maximum number of keys have been programmed.
Not Enough Keys Learned	Displayed during spare key programming when not enough keys have been programmed.
Key Battery Low Replace Soon	Displays when the key battery is low. Change the battery as soon as possible.
Could Not Program Integrated Key	Displayed when an attempt is made to program a spare key using two existing MyKeys.
Engine On	Displayed as a reminder that the engine is on.

## Lane Keeping System

Message	Action
Lane Keeping Sys. Malfunction Service Required	The system has malfunctioned. Contact your authorized dealer as soon as possible.
Front Camera Temporarily Not Available	The system has detected a condition that has caused the system to be temporarily unavailable.
Front Camera Low Visibility Clean Screen	The system has detected a condition that requires the windshield to be cleaned to operate properly.
Front Camera Malfunction Service Required	The system has malfunctioned. Contact your authorized dealer as soon as possible.
Keep Hands on Steering Wheel	Displayed when the system requests the driver to keep their hands on the steering wheel.

# Information Displays

## Maintenance

Message	Action
LOW Engine Oil Pressure	Stop the vehicle as soon as safely possible, turn off the engine. Check the oil level. If the warning stays on or continues to come on with your engine running, contact your authorized dealer as soon as possible.
Change Engine Oil Soon	Displayed when the engine oil life remaining is 10% or less. See <b>Engine Oil Check</b> (page 288).
Oil Change Required	Displayed when the oil life left reaches 0%. See <b>Engine Oil Check</b> (page 288).
Brake Fluid Level LOW	Indicates the brake fluid level is low and the brake system should be inspected immediately. See <b>Brake Fluid Check</b> (page 294).
Check Brake System	Displays when the brake system needs servicing. Stop the vehicle in a safe place. Contact your authorized dealer.
Engine Coolant Overtemperature	Displays when the engine coolant temperature is excessively high. Stop the vehicle in a safe place and contact your authorized dealer.
Motor Coolant Overtemperature	Displays when the motor electronics are overheating. Stop the vehicle as soon as safely possible, turn off the vehicle and let it cool. If the warning stays on or continues to come on, contact your authorized dealer as soon as possible.
Washer Fluid Level Low	Displays when the washer fluid is low and needs to be refilled.
Power Reduced to Lower Engine Temp	Displays when the engine has reduced power in order to help reduce high coolant temperatures.

## Information Displays

Message	Action
Service Tire Mobility Kit	Displayed when the kit needs service. See your authorized dealer.
Transport / Factory Mode	Displays to indicate that the vehicle is still in Transport or Factory mode. This may not allow some features to operate properly. See your authorized dealer.
See Manual	Informs the driver that the powertrain needs service due to a powertrain malfunction.

### MyKey

Message	Action
MyKey Not Created	Displayed during key programming when MyKey cannot be programmed.
MyKey Active Drive Safely	Displays when MyKey is active.
Speed Limited to XX MPH/km/h	Displays when starting the vehicle and MyKey is in use and the MyKey speed limit is on.
Near Vehicle Top Speed	Displays when a MyKey is in use and the MyKey speed limit is on and the vehicle speed is approaching 80 mph (130 km/h).
Vehicle at Top Speed of MyKey Setting	Displays when a MyKey is in use and the MyKey speed limit is reached.
Check Speed Drive Safely	Displays when MyKey is active.
Buckle Up to Unmute Audio	Displays when a MyKey is in use and Belt-Minder is activated.
AdvanceTrac On - MyKey Setting	Displays when a MyKey is in use and AdvanceTrac is activated.

# Information Displays

Message	Action
Traction Control On - MyKey Setting	Displays when a MyKey is in use and Traction control is activated.
MyKey Park Aid Cannot Be Deactivated	Displays when a MyKey is in use and park aid is activated.
Lane Keeping Alert On MyKey Setting	Displayed when the lane keeping aid is on per MyKey settings.

## Park Aid

Message	Action
Check Front Park Aid	Displays when the system has detected a condition that requires service. Contact your authorized dealer. See <b>Parking Aid</b> (page 201).
Check Rear Park Aid	Displays when the system has detected a condition that requires service. Contact your authorized dealer. See <b>Parking Aid</b> (page 201).
Front Park Aid On Off	Displays the park aid status.
Rear Park Aid On Off	Displays the park aid status.

# Information Displays

## Park Brake

Message	Action
Park Brake Engaged	Displays when the parking brake is set, the engine is running and the vehicle is driven more than 3 mph (5 km/h). If the warning stays on after the parking brake is released, contact your authorized dealer.
Park Brake Malfunction Service Now	The electric parking brake system has detected a condition that requires service. See your authorized dealer.
Park Brake Not Applied	Displays when the electric parking brake is not set.
Park Brake Maintenance Mode	Displays when the electric parking brake is running a diagnostic check.
Park Brake Use Switch to Release	Displays when the electric parking brake is set but has not been released.
Press Brake to Release Park Brake and switch	Displays when the electric parking brake is set but has not been released and the vehicle is moving.
Park Brake Limited Function Service Required	The electric park brake system has detected a condition that requires service. See your authorized dealer.
Park Brake System Overheated	Displays when the electric parking brake was not released causing it to overheat.
Release Park Brake	Displays when the electric parking brake is set and the vehicle is started.
Park Brake Applied	Displays when the electric parking brake is set.
Park Brake Released	Displays when the electric parking brake is released.

# Information Displays

## Power Steering

Message	Action
Steering Fault Service Now	The power steering system has detected a condition that requires service. See your authorized dealer.
Steering Loss Stop Safely	The power steering system is not working. Stop the vehicle a safe place. Contact your authorized dealer.
Steering Assist Fault Service Required	The power steering system has detected a condition within the power steering system or passive entry or passive start system requires service. Contact your authorized dealer.

## Pre-Collision Assist

Message	Action
Pre-Collision Assist Malfunction	Displayed when there is a system malfunction with the collision warning system. The system will be disabled. Contact your authorized dealer as soon as possible.
Pre-Collision Assist Not Available Sensor Blocked See Manual	Displayed when the collision warning system radar is blocked because of poor radar visibility due to bad weather or ice/mud/water in front of the radar. Driver can typically clean the sensor to resolve. Contact your authorized dealer as soon as possible.
Pre-Collision Assist Not Available	Displayed when there is a system malfunction with the collision warning system. The system will be disabled. Contact your authorized dealer as soon as possible.

# Information Displays

## Remote Start

Message	Action
To Drive: Turn Key to On	Displays as a reminder to turn the key on to drive the vehicle after a remote start.
To Drive: Press Brake and Gear Shift Button	Displays as a reminder to apply the brake and the gear shift button to drive the vehicle after a remote start.

## Seats

Message	Action
Memory Recall Not Permitted While Driving	Displays as a reminder that memory seats are not available while driving.
Memory X Saved	Displays to show where your memory setting has been saved.

## Starting System

Message	Action
Press Brake to Start	Displays when starting the vehicle as a reminder to apply the brake.
Cranking Time Exceeded	Displays when the starter has exceeded its cranking time in attempting to start the vehicle.
Engine Start Pending Please Wait	Displays when the starter is attempting to start the vehicle.
Pending Start Cancelled	Displays when the pending start has been cancelled.

# Information Displays

## Tire Pressure Monitoring System

Message	Action
LOW Tire Pressure	Displays when one or more tires on your vehicle have low tire pressure. See <b>Tire Pressure Monitoring System</b> (page 339).
Tire Pressure Monitor Fault	Displays when the tire pressure monitoring system is malfunctioning. If the warning stays on or continues to come on, contact your authorized dealer. See <b>Tire Pressure Monitoring System</b> (page 339).
Tire Pressure Sensor Fault	Displayed when a tire pressure sensor is malfunctioning, or your spare tire is in use. For more information on how the system operates under these conditions, See <b>Tire Pressure Monitoring System</b> (page 339). If the warning stays on or continues to come on, contact your authorized dealer as soon as possible.

## Traction Control

Message	Action
Traction Control Off / On	Displays when the traction control system has been switched off or on. See <b>Using Traction Control</b> (page 197).
Spinout Detected Hazards Activated	Displays when a spinout has occurred and your vehicle has activated the hazard warning flashers.

# Information Displays

## Transmission

Message	Action
Transmission Malfunction Service Now	See your authorized dealer.
Transmission Overheating Stop Safely	The transmission is overheating and needs to cool. Stop in a safe place as soon as it's possible.
Transmission Overtemperature Stop Safely	The transmission has overheated and needs to cool. Stop in a safe place as soon as it's possible.
Transmission Service Required	See your authorized dealer.
Transmission Too Hot Press Brake	Transmission is getting hot. Stop to let it cool.
Transmission Limited Function See Manual	Displays when the transmission has overheated and has limited functionality. See <b>Automatic Transmission</b> (page 187).
Transmission Warming Up Please Wait	Transmission is too cold. Wait for it to warm up before you drive.
Transmission Not in Park	A reminder to shift into park. In addition, this message is typical after reconnecting or recharging the battery until you cycle the ignition to the on mode. See <b>Changing the 12V Battery</b> (page 295).
Transmission Adjusted	Displays when the transmission has adjusted the shift strategy.
Transmission Adapt Mode	Displays when the transmission is adjusting the shift strategy.
Transmission Indicate Mode Lockup On	Displays when the transmission shift lever is locked and unable to select gears.
Transmission Indicate Mode Lockup Off	Displays when the transmission shift lever is unlocked and free to select gears.
Invalid Gear Selection	Displays when an invalid gear has been selected.

## Information Displays

Message	Action
Press Brake Pedal	Displays to request the operator to apply the brake as needed by the transmission.
Depress Brake to Shift from Park	Displays when the brake pedal needs to be depressed to enable the transmission to shift from park.
Press N again to Enter Stay in Neutral Mode	Displays when the neutral button N needs to be pressed again to enter neutral hold. See <b>Automatic Transmission</b> (page 187).
Stay in Neutral Mode Engaged	Displays when neutral hold is active. See <b>Automatic Transmission</b> (page 187).
Stay in Neutral Tow Engaged See Manual to Disable	Displays when neutral hold is active. See (page 109).
SHIFT SYS FAULT Confirm Park Brake Apply Before Exiting the Vehicle	Displays when there is a system fault and the park brake needs to be depressed before exiting the vehicle. See your authorized dealer.
SHIFT SYS FAULT Cannot Shift Trans Use Park Brake to Secure Vehicle	Displays when there is a system fault and the park brake needs to be depressed before exiting the vehicle. See your authorized dealer.
SHIFT SYS FAULT Service Required	See your authorized dealer.
SHIFT SYS FAULT Vehicle is Shifting to Park	Displays when there is a system fault while the vehicle is shifting to park. See your authorized dealer.
SHIFT SYS FAULT Reverse Unavailable Service Required	Displays when there is a system fault while the vehicle is shifting to reverse. See your authorized dealer.
SHIFT SYS FAULT Drive Unavailable Select L for Drive Service Required	See your authorized dealer.

## Information Displays

Message	Action
SHIFT SYS FAULT Neutral Unavailable Service Required	See your authorized dealer.
SHIFT SYS FAULT Low Unavailable Service Required	See your authorized dealer.
Neutral Tow Engaged Turn Ignition Off for Towing	Displays when neutral tow is active and the ignition needs to be turned off. See <b>Towing the Vehicle on Four Wheels</b> (page 248).
Neutral Tow Engaged Depress Brake and Select Park to Exit Neutral Tow	Displays while attempting to exit neutral tow. The brake pedal needs to be depressed and park button selected to deactivate. See <b>Towing the Vehicle on Four Wheels</b> (page 248).
Neutral Tow Remove Park Brake for Towing	Displays when neutral tow is active and the park brake needs to be released. See <b>Towing the Vehicle on Four Wheels</b> (page 248).
Neutral Tow Disengaged	Displays when neutral tow has been deactivated.

# Climate Control

## AUTOMATIC CLIMATE CONTROL

**Note:** You can switch temperature units between Fahrenheit and Celsius. See **Settings** (page 372).

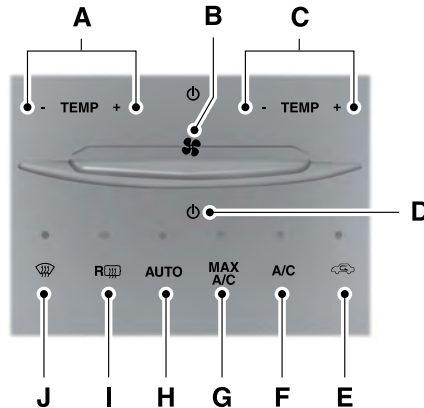

E146320

- A Driver temperature controls:** Press + or - to increase or decrease the air temperature for the driver side of the vehicle. This control also adjusts the passenger side temperature when not in dual zone mode.
- B Fan speed control:** Press on either side of the fan icon to increase or decrease the volume of air circulated in the vehicle.
- C Passenger temperature controls:** Press + or - to increase or decrease the air temperature on the passenger side of the vehicle. This turns on dual zone mode.

# Climate Control

---

- D **Power:** Press the button to turn the system on and off. Switching off the climate control system prevents outside air from entering the vehicle.
- E **Recirculated air:** Press the button to switch between outside air and recirculated air. When you select recirculated air, the air currently in the passenger compartment recirculates. This may reduce the time needed to cool the interior (when used with **A/C** and may reduce unwanted odors from entering your vehicle.
- Note:** Recirculated air may turn off automatically (or be prevented from turning on) in all airflow modes except **MAX A/C** to reduce the risk of fogging. Recirculation may also turn on and off automatically in Panel or Panel and Floor airflow modes during hot weather in order to improve cooling efficiency.
- F **A/C:** Press the button to turn air conditioning compressor on or off. Use air conditioning with recirculated air to improve cooling performance and efficiency.
- G **MAX A/C:** Press the button to maximize cooling. Recirculated air flows through the instrument panel vents, air conditioning automatically turns on, and the fan automatically adjusts to the highest speed.
- H **AUTO:** Press the button to turn on automatic operation. Select the desired temperature using the temperature control. The system adjusts fan speed, air distribution, air conditioning operation, and selects outside air or recirculated air to heat or cool the vehicle in order to maintain the desired temperature. You can also use the **AUTO** button to turn off dual zone operation by pressing and holding the button for more than two seconds.
- I **Heated rear window:** Turns the heated rear window on and off. See **Heated Windows and Mirrors** (page 142).
- J **Defrost:** Press the button to distribute air to the windshield vents and de-mister. Air distribution to instrument panel and footwell vents turn off. You can use this setting to defog and clear the windshield of a thin covering of ice.

# Climate Control

---

## HINTS ON CONTROLLING THE INTERIOR CLIMATE

### General Hints

**Note:** Prolonged use of recirculated air may cause the windows to fog up.

**Note:** You may feel a small amount of air from the footwell air vents regardless of the air distribution setting.

**Note:** To reduce humidity build-up inside your vehicle, do not drive with the system switched off or with recirculated air always switched on.

**Note:** Do not place objects under the front seats as this may interfere with the airflow to the rear seats.

**Note:** Remove any snow, ice or leaves from the air intake area at the base of the windshield.

**Note:** To improve the time to reach comfort in hot weather, drive with the windows slightly open for 2-3 minutes after start-up or until your vehicle airs out.

### Automatic Climate Control

**Note:** Adjusting the settings when your vehicle interior is extremely hot or cold is not necessary. The system automatically adjusts to heat or cool the cabin to your selected temperature as quickly as possible. For the system to function efficiently, the instrument panel and side air vents should be fully open.

**Note:** If you select **AUTO** during cold outside temperatures, the system directs airflow to the windshield and side window vents. In addition, the fan may run at a slower speed until the engine warms up.

**Note:** If you select **AUTO** during hot outside temperatures, or when the inside of the vehicle is hot, the system automatically uses recirculated air to maximize interior cooling. When the interior reaches the selected temperature, the system automatically switches to using outside air.

### Heating the Interior Quickly

1. Press the **AUTO** button.

2. Adjust the temperature control to the desired setting.

### Recommended Settings for Heating

1. Press the **AUTO** button.
2. Adjust the temperature control to the desired setting. Use 72°F (22°C) as a starting point, then adjust the setting as necessary.

### Cooling the Interior Quickly

Press the **MAX A/C** button.

### Recommended Settings for Cooling

1. Press the **AUTO** button.
2. Adjust the temperature control to the desired setting. Use 72°F (22°C) as a starting point, then adjust the setting as necessary.

### Side Window Defogging in Cold Weather

1. Press the defrost button.

# Climate Control

2. Adjust the temperature control to the desired setting. Use 72°F (22°C) as a starting point, then adjust the setting as necessary.
3. Direct the instrument panel side air vents toward the side windows.
4. Close the instrument panel vents.

## HEATED WINDOWS AND MIRRORS

### Heated Rear Window

**Note:** You must switch the ignition on to use this feature.



Press the button to clear the rear window of thin ice and fog. Press the button again within 10 minutes to switch it off. It switches off automatically after 10 minutes, or when you switch the ignition off.

**Do not use razor blades or other sharp objects to clean the inside of the rear window or to remove decals from the inside of the rear window. This may cause damage to the heated grid lines, which your warranty does not cover.**

### Heated Exterior Mirror

**Note:** Do not remove ice from the mirrors with a scraper or attempt to readjust the mirror glass if it has frozen in place. These actions could cause damage to the glass and mirrors.

**Note:** Do not clean the housing or glass of any mirror with harsh abrasives, fuel or other petroleum-based cleaning products.

Both heated mirrors remove ice, mist and fog when you switch on the heated rear window.

## CABIN AIR FILTER

Your vehicle is equipped with a cabin air filter. It is located behind the glove box.

The particulate filtration system reduces the concentration of airborne particles such as dust, spores and pollen in the air supplied to the interior of your vehicle.

**Note:** To prevent foreign objects from entering the system, make sure the cabin air is in place at all times. Running the system without a filter in place could result in degradation or damage to the system.

The particulate filtration system gives you and your passengers the following benefits:

- It improves your driving comfort by reducing particle concentration.
- It improves the interior compartment cleanliness.
- It protects the climate control components from particle deposits.

Replace the filter at regular intervals. See **Scheduled Maintenance** (page 468).

For additional cabin air filter information, or to replace the filter, see an authorized dealer.

# Climate Control

---

## REMOTE START

The remote start feature allows you to pre-condition the interior of your vehicle. The climate control system works to achieve comfort according to your previous settings.

**Note:** *You cannot adjust the system during remote start operation.*

Turn the ignition on to return the system to its previous settings. You can now make adjustments normally, but you need to turn certain vehicle-dependent features back on, such as:

- Heated seats.
- Cooled seats.
- Heated steering wheel.
- Heated mirrors.
- Heated rear window.

You can adjust the default remote start settings using the information display controls. See **Information Displays** (page 109).

## Automatic Settings

In hot weather, the system is set to 72°F (22°C). The cooled seats are set to high (if available, and selected to AUTO in the information display).

In moderate weather, the system either heats or cools (based on previous settings). The rear defroster, heated mirrors and heated seats do not automatically switch on.

In cold weather, the system is set to 72°F (22°C). The heated seats are set to high (if available, and selected to AUTO in the information display). The rear defroster and heated mirrors automatically switch on.

# Seats

## SITTING IN THE CORRECT POSITION

### WARNINGS

 Sitting improperly, out of position or with the seat back reclined too far can take weight off the seat cushion and affect the decision of the passenger sensing system, resulting in serious injury or death in the event of a crash. Always sit upright against your seat back, with your feet on the floor.

 Do not recline the seat back as this can cause the occupant to slide under the safety belt, resulting in serious injury in the event of a crash.

 Do not place objects higher than the seat back to reduce the risk of serious injury in the event of a crash or during heavy braking.

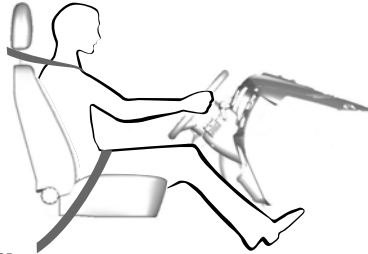

E68595

When you use them properly, the seat, head restraint, safety belt and air bags will provide optimum protection in the event of a crash.

We recommend that you follow these guidelines:

- Sit in an upright position with the base of your spine as far back as possible.
- Do not recline the seat back more than 30 degrees.
- Adjust the head restraint so that the top of it is level with the top of your head and as far forward as possible. Make sure that you remain comfortable.

- Keep sufficient distance between yourself and the steering wheel. We recommend a minimum of 10 inches (25 centimeters) between your breastbone and the air bag cover.
- Hold the steering wheel with your arms slightly bent.
- Bend your legs slightly so that you can press the pedals fully.
- Position the shoulder strap of the safety belt over the center of your shoulder and position the lap strap tightly across your hips.

Make sure that your driving position is comfortable and that you can maintain full control of your vehicle.

## HEAD RESTRAINTS

### WARNINGS

 Fully adjust the head restraint before you sit in or operate your vehicle. This will help minimize the risk of neck injury in the event of a crash. Do not adjust the head restraint when your vehicle is moving.

# Seats

## WARNINGS

 The adjustable head restraint is a safety device. Whenever possible, it should be installed and properly adjusted when the seat is occupied. Failure to adjust the head restraint properly could reduce its effectiveness during certain impacts.

 Install the head restraint properly to help minimize the risk of neck injury in the event of a crash.

**Note:** *Adjust the seatback to an upright driving position before adjusting the head restraint. Adjust the head restraint so that the top of it is level with the top of your head and as far forward as possible. Make sure that you remain comfortable. If you are extremely tall, adjust the head restraint to its highest position.*

## Front seat head restraint

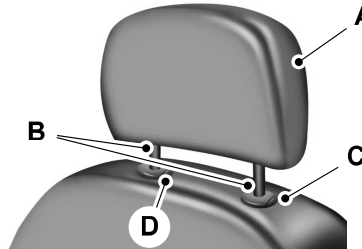

E138642

## Rear seat outboard head restraints

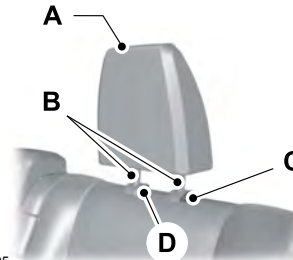

E153105

## Rear center head restraint

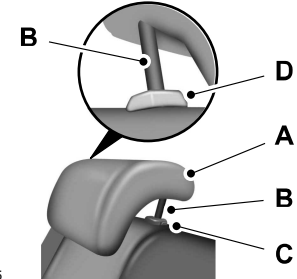

E138645

The head restraints consist of:

- A an energy absorbing head restraint
- B two steel stems
- C guide sleeve adjust and unlock button
- D guide sleeve unlock and remove button

## Adjusting the Head Restraint

### Raising the Head Restraint

Pull the head restraint up.

# Seats

## Lowering the Head Restraint

1. Press and hold button C.
2. Push the head restraint down.

## Removing the Head Restraint

1. Pull the head restraint up until it reaches its highest position.
2. Press and hold buttons C and D.
3. Pull the head restraint up.

## Installing the Head Restraint

Align the steel stems into the guide sleeves and push the head restraint down until it locks.

## Tilting Head Restraints

The front head restraints have a tilting feature for extra comfort. To tilt the head restraint, do the following:



E144727

1. Adjust the seatback to an upright driving or riding position.

2. Pivot the head restraint forward toward your head to the desired position.

After the head restraint reaches the forward-most tilt position, pivoting it forward again will then release it to the rearward, untilted position.

## POWER SEATS

### WARNINGS



Do not adjust the front seat or seatback while your vehicle is moving. This may result in sudden seat movement, causing the loss of control of your vehicle.



Do not place cargo or any objects behind the seatback before returning it to the original position.

# Seats

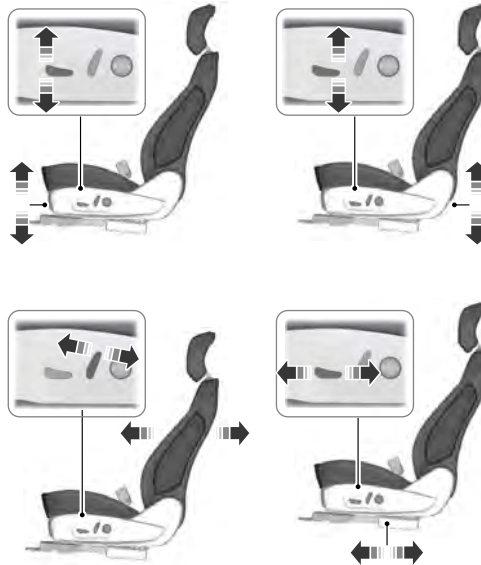

E144632

# Seats

## Power Lumbar

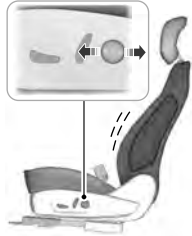

E165608

## Multi-Contour Front Seats With Active Motion (If Equipped)

**Note:** The massage system will turn off after 20 minutes.

**Note:** The engine must be running or the vehicle must be in accessory mode to activate the seats.

**Note:** Allow a few seconds for any selection to activate. The seatback and cushion massage cannot function at the same time.

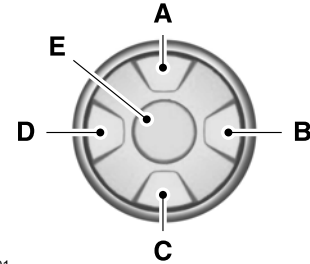

E156301

	Message mode	Lumbar and bolster mode
A	Back massage intensity adjustment	Upper lumbar
B	Massage intensity decrease and off <sup>1</sup>	Lumbar decrease
C	Cushion massage intensity adjustment	Lower lumbar <sup>2</sup>
D	Massage intensity increase	Lumbar increase
E	On and off	-

# Seats

<sup>1</sup>The massage feature will default to an alternating massage mode with back massage intensity adjustment. The lumbar and bolster feature will default to the middle lumbar mode.

<sup>2</sup>Press C a second time to adjust the back bolster. Press C a third time to adjust the cushion bolster.

You can also adjust this feature through the touchscreen.



Press the Menu Settings icon, then Vehicle. Choose Multi-Contour Seats.

When switched on, the system displays directions for you to adjust the lumbar settings in your seat or to set the massage function.

To access and make adjustments to the lumbar setting:

1. Choose the desired seat to adjust.
2. Press the + or - to adjust the lumbar intensity.

To access and make adjustments to the massage setting:

1. Press the Menu Settings icon, then Vehicle. Choose Multi-Contour Seats.
2. Choose the desired seat to adjust.
3. Press OFF, LO or HI.

## MEMORY FUNCTION

### WARNINGS



Before activating the seat memory, make sure that the area immediately surrounding the seat is clear of obstructions and that all occupants are clear of moving parts.



Do not use the memory function when your vehicle is moving.

This feature will automatically recall the position of the driver seat, power mirrors and optional power steering column. The memory control is located on the driver door.



E142554

## Saving a PreSet Position

1. Switch the ignition on.
2. Adjust the seat, exterior mirrors and power steering column to your desired position.
3. Press and hold the desired preset button until you hear a single tone.

You can save up to three preset memory positions. You can save a memory preset at any time.

# Seats

## Recalling a PreSet Position

Press and release the preset button associated with your desired driving position. The seat, mirrors and steering column will move to the position stored for that preset.

**Note:** *A pre-set memory position can only be recalled when the ignition is off, or when the transmission is in park (P) or neutral (N) if the ignition is on.*

You can also recall a preset memory position by:

- Pressing the unlock button on your intelligent access key fob if it is linked to a preset position.
- Unlocking the intelligent driver door handle if a linked key fob is present.
- Entering a personal entry code on the Securicode keypad. See **Locks** (page 65).

**Note:** *Using a linked key fob to recall your memory position when the ignition is off will move the seat to the Easy Entry position.*

**Note:** *Pressing any seat or mirror adjustment control (or any memory button) during a memory recall cancels the operation.*

Seat recall movement will also stop if you drive your vehicle.

## Linking a PreSet Position to your Remote Control or Intelligent Access Key Fob

Your vehicle can save the preset memory positions for up to three remote controls or intelligent access (IA) keys.

1. With the ignition on, move the memory positions to the desired positions.
2. Press and hold the desired preset button for about five seconds. A tone will sound after about two seconds. Continue holding until a second tone is heard.
3. Within three seconds, press the lock button on the remote control you are linking.

To unlink a remote control, follow the same procedure – except in step 3, press the unlock button on the remote control.

**Note:** *If more than one linked remote control or IA key is in range, the memory function will move to the settings of the first key stored.*

## Easy Entry and Exit Feature

If you enable the easy entry and exit feature, it automatically moves the driver seat position rearward up to two inches (five centimeters) when you switch the ignition off.

The driver seat will return to the previous position when you switch the ignition on.

You can enable or disable this feature in the information display. See **Information Displays** (page 109).

## REAR SEATS

**Note:** *Your vehicle may have split seatbacks that you must fold individually.*

**Note:** *Make sure the center safety belt is unbuckled before folding the seatback.*

To lower the seat back(s) from inside the vehicle, do the following:

# Seats



E144634

1. Pull the handle to release the seatback.
2. Push the seatback forward.

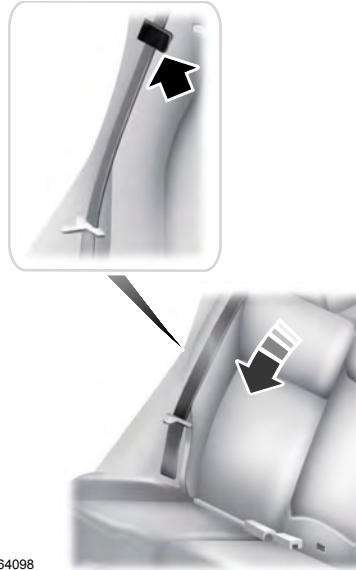

E164098

3. Stow the safety belt in the stowage clip. This will prevent the safety belt from getting caught in the seat latch.

When raising the seat back(s), make sure you hear the seat latch into place.

## HEATED SEATS

### Front Seats

#### WARNING

 People who are unable to feel pain to their skin because of advanced age, chronic illness, diabetes, spinal cord injury, medication, alcohol use, exhaustion or other physical conditions, must exercise care when using the heated seat. The heated seat may cause burns even at low temperatures, especially if used for long periods of time. Do not place anything on the seat that insulates against heat, such as a blanket or cushion. This may cause the heated seat to overheat. Do not puncture the seat with pins, needles or other pointed objects. This may damage the heating element which may cause the heated seat to overheat. An overheated seat may cause serious personal injury.

# Seats

Do not do the following:

- Place heavy objects on the seat.
- Operate the heated seat if water or any other liquid is spilled on the seat. Allow the seat to dry thoroughly.
- Operate the heated seats unless the engine is running. Doing so can cause the battery to lose charge.



E146322

Touch the heated seat symbol to cycle through the various heat settings and off. Warmer settings are indicated by more indicator lights.

## Rear Heated Seats (If Equipped)

### WARNING

 Persons who are unable to feel pain to the skin because of advanced age, chronic illness, diabetes, spinal cord injury, medication, alcohol use, exhaustion, or other physical conditions, must exercise care when using the seat heater. The seat heater may cause burns even at low temperatures, especially if used for long periods of time. Do not place anything on the seat that insulates against heat, such as a blanket or cushion, because this may cause the seat heater to overheat. Do not puncture the seat with pins, needles, or other pointed objects because this may damage the heating element which may cause the seat heater to overheat. An overheated seat may cause serious personal injury.

**Note:** *Do not do the following:*

- Place heavy objects on the seat.
- Operate the seat heater if water or any other liquid is spilled on the seat. Allow the seat to dry thoroughly.

The rear seat heat controls are located on the rear of the center console.

The heated seats only operate when the ignition is on.



E146322

- Press the heated seat symbol to cycle through the various heat settings and off. Warmer settings are indicated by more indicator lights.
- Press again to deactivate.

The heated seat module resets at every ignition run cycle. While the ignition is on, press the high or low heated seat switch to enable heating mode. When activated, they will turn off automatically when you turn the engine off.

# Seats

## CLIMATE CONTROLLED SEATS (If

Equipped)

### Heated Seats

#### WARNING



People who are unable to feel pain to their skin because of advanced age, chronic illness, diabetes, spinal cord injury, medication, alcohol use, exhaustion or other physical conditions, must exercise care when using the heated seat. The heated seat may cause burns even at low temperatures, especially if used for long periods of time.

Do not place anything on the seat that insulates against heat, such as a blanket or cushion. This may cause the heated seat to overheat. Do not puncture the seat with pins, needles or other pointed objects. This may damage the heating element which may cause the heated seat to overheat. An overheated seat may cause serious personal injury.

Do not do the following:

- Place heavy objects on the seat.
- Operate the heated seat if water or any other liquid is spilled on the seat. Allow the seat to dry thoroughly.
- Operate the heated seats unless the engine is running. Doing so can cause the battery to lose charge.



E146322

Touch the heated seat symbol to cycle through the various heat settings and off. Warmer settings are indicated by more indicator lights.

### Cooled Seats (If Equipped)

The cooled seats will only function when the engine is running.



E146309

To operate the cooled seats, press the cooled seat symbol to cycle through the various cooling settings and off. Cooler settings are indicated by more indicator lights.

If the engine falls below 350 RPM while the cooled seats are on, the feature will turn itself off. You will need to reactivate it.

### Heated and cooled seat air filter replacement (if equipped)

Your vehicle is equipped with lifetime air filters that are integrated with the seats. Regular maintenance or replacement is not needed.

# Seats

## REAR SEAT ARMREST



E144635

Fold the armrest down to use the armrest and cupholder. To open the storage lid, pull up on the latch located between the cupholders.

### Armrest pass-through

**Note:** Do not exceed 80 pounds (36 kilograms) of weight on the pass-through door.



E152622

Release the latch, then pull down on the door located in the back of the armrest. You can store cargo of a longer length such as skis or lumber.

# Universal Garage Door Opener

## HomeLink Wireless Control System (if Equipped)

### WARNING

 Do not use the system with any garage door opener that does not have the safety stop and reverse feature as required by U.S. Federal Safety Standards (this includes any garage door opener manufactured before April 1, 1982). A garage door opener which cannot detect an object, signaling the door to stop and reverse, does not meet current federal safety standards. Using a garage door opener without these features increases the risk of serious injury or death.

**Note:** Make sure that the garage door and security device are free from obstruction when you are programming. Do not program the system with the vehicle in the garage.

**Note:** Make sure you keep the original remote control transmitter for use in other vehicles as well as for future system programming.

**Note:** We recommend that upon the sale or lease termination of your vehicle, you erase the programmed function buttons for security reasons. See *Erasing the function button codes later in this section.*

**Note:** You can program a maximum of three devices. To change or replace any of the three devices after it has been initially programmed, you must first erase the current settings. See *Erasing the function button codes later in this section.*



E142657

The universal garage door opener replaces the common hand-held garage door opener with a three-button transmitter that is integrated into the driver's sun visor.

The system includes two primary features, a garage door opener and a platform for remote activation of devices within the home. As well as being programmed for garage doors, the system transmitter can be programmed to operate entry gate operators, security systems, entry door locks and home or office lighting.

Additional system information can be found online at [www.homelink.com](http://www.homelink.com) or by calling the toll-free help line on 1-800-355-3515.

### In-vehicle programming

This process is to program your hand-held transmitter and your in-vehicle HomeLink button.

**Note:** Put a new battery in the hand-held transmitter. This will ensure quicker training and accurate transmission of the radio-frequency signal.

# Universal Garage Door Opener

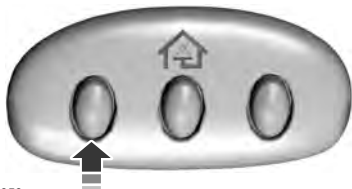

E142658

1. With your vehicle parked outside of the garage, turn your ignition to the **on** position, but do not start your vehicle.
2. Hold your hand-held garage door transmitter 1–3 inches (2–8 centimeters) away from the HomeLink button you want to program.
3. Using both hands, simultaneously, press and hold the desired HomeLink button and the hand-held transmitter button. DO NOT release either one until the HomeLink indicator light flashes slowly and then rapidly. When the indicator light flashes rapidly, both buttons may be released. The rapid flashing indicates successful training.

4. Press and hold the HomeLink button you programmed for five seconds, then release. You may need to do this twice to activate the door. If your garage door does not operate, watch the HomeLink indicator light.

If the indicator light stays on, the programming is complete. See **Programming your garage door motor** later in this section.

If the indicator light flashes rapidly for 2 seconds and then turns to a constant light, the HomeLink button is not programmed yet. Do the following:

Press and hold the HomeLink button while you press and release the hand-held transmitter button every 2 seconds. The HomeLink indicator light will flash slowly and then rapidly once the HomeLink function button recognizes and accepts the hand-held transmitter's radio frequency signal.

After programming the HomeLink button, begin programming your garage door opener motor.

**Note:** You may need a ladder to reach the unit and you may need to remove the cover or lamp lens on your garage door opener.



E142659

To program additional buttons, repeat Steps 1 – 4.

For questions or comments, please contact HomeLink at [www.homelink.com](http://www.homelink.com) or 1-800-355-3515.

## Programming your garage door opener motor

1. Press the learn button on the garage door opener motor and then you have 30 seconds to complete the next two steps.
2. Return to your vehicle.

# Universal Garage Door Opener

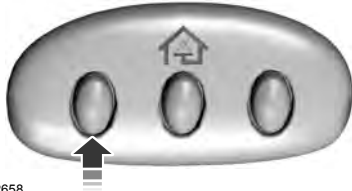

E142658

3. Press and hold the function button you want to program for 2 seconds, then release. Repeat this step. Depending on your brand of garage door opener, you may need to repeat this sequence a third time.

## Erasing the Function Button Codes

**Note:** You cannot erase individual buttons.

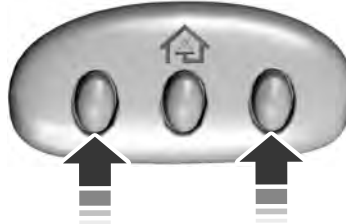

E142660

1. Press and hold the outer two function buttons simultaneously for approximately 20 seconds until the indicator lights above the buttons flash rapidly.
2. When the indicator lights flash, release the buttons. The codes for all buttons are erased.

## Reprogramming a Single Button

To program a device to a previously trained button, follow these steps:

1. Press and hold the desired button. Do NOT release the button.

2. The indicator light will begin to flash after 20 seconds. Without releasing the button, follow Step 1 in the Programming section.

For questions or comments, contact HomeLink at [www.homelink.com](http://www.homelink.com) or 1-800-355-3515.

## Programming to a Genie Intellicode 2 Garage Door Opener

**Note:** The Genie Intellicode 2 transmitter must already be programmed to operate with the garage door opener.

**Note:** To program HomeLink to the transmitter you must first put the transmitter into programming mode.

# Universal Garage Door Opener

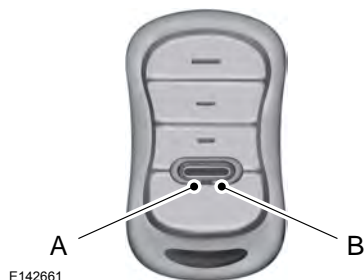

E142661

- A. Red indicator light
- B. Green indicator light

1. Press and hold one of the buttons on the hand-held transmitter for 10 seconds. The indicator light will change from green to red and green.
2. Press the same button twice to confirm the change to programming mode. If done properly the indicator light will appear red.
3. Hold the transmitter within 1–3 inches (2–8 centimeters) of the button on the visor you want to program.

4. Press and hold both the programmed Genie button on the hand-held transmitter and the button you want to program. The indicator light on the visor will flash rapidly when the programming is successful.

**Note:** The Genie transmitter will transmit for up to 30 seconds. If HomeLink does not program within 30 seconds the Genie transmitter will need to be pressed again. If the Genie transmitter indicator light displays green and red, release the button until the indicator light turns off before pressing the button again.

Once HomeLink has been programmed successfully, the Genie transmitter must be changed out of program mode. To do this:

1. Press and hold the previously programmed Genie button on the hand-held transmitter for 10 seconds. The indicator light will change from red to red and green.
2. Press the same button twice to confirm the change. If done correctly the indicator light will turn green.

## Programming HomeLink to the Genie Intellicode Garage Door Opener Motor

**Note:** You may need a ladder to access the garage door opener motor.

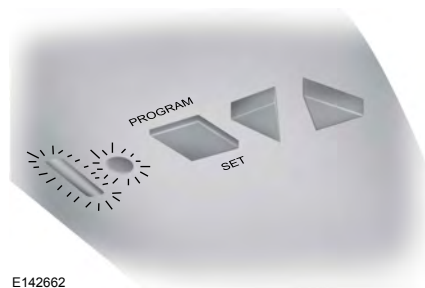

E142662

1. Press and hold the program button on the garage door opener motor until both blue indicator lights turn on.
2. Release the program button. Only the smaller round indicator light should be on.
3. Press and release the program button. The larger purple indicator light will flash.

**Note:** The next two steps must be completed in 30 seconds.

# Universal Garage Door Opener

---

4. Press and release the Genie Intellicode 2 hand-held transmitter's previously programmed button. Both indicator lights on the garage door opener motor unit should now flash purple.
5. Press and hold the previously programmed button on the visor for 2 seconds. Repeat this step up to 3 times until the garage door moves.

Programming is now complete.

## **Clearing a HomeLink Device**

To erase programming from the three HomeLink buttons press and hold the two outer HomeLink buttons until the indicator light begins to flash. The indicator light will begin flashing in 10 to 20 seconds, at which time both buttons should be released. Programming has now been erased, and the indicator light should blink slowly to indicate the device is in train mode when any of the three HomeLink buttons are pressed.

## **FCC and RSS-210 Industry Canada Compliance**

This device complies with Part 15 of the FCC Rules and with RSS-210 of Industry Canada. Operation is subject to the following two conditions: (1) this device may not cause harmful interference, and (2) this device must accept any interference received, including interference that may cause undesired operation.

Changes or modifications to your device not expressly approved by the party responsible for compliance can void the user's authority to operate the equipment.

# Auxiliary Power Points

## 12 Volt DC Power Point

### WARNING

 Do not plug optional electrical accessories into the cigar lighter socket (if equipped). Improper use of the lighter can cause damage not covered by your warranty, and can result in fire or serious injury.

**Note:** *If used when the vehicle is not running, the battery will discharge. There may be insufficient power to restart your vehicle.*

**Note:** *Do not insert objects other than an accessory plug into the power point. This will damage the outlet and blow the fuse.*

**Note:** *Do not hang any type of accessory or accessory bracket from the plug.*

**Note:** *Do not use the power point over the vehicle capacity of 12 volt DC 180 watts or a fuse may blow.*

**Note:** *Do not use the power point for operating a cigar lighter element.*

**Note:** *Improper use of the power point can cause damage not covered by your warranty.*

**Note:** *Always keep the power point caps closed when not in use.*

Run the vehicle for full capacity use of the power point. To prevent the battery from discharging accidentally:

- Do not use the power point longer than necessary when the vehicle is not running.
- Do not leave devices plugged in overnight or when you park your vehicle for extended periods.

### Locations

Power points may be in the following locations:

- in the front of the center console
- inside the center console storage bin
- on the rear of the center console.

## 110 Volt AC Power Point (If Equipped)

### WARNING

 Do not keep electrical devices plugged in the power point whenever the device is not in use. Do not use any extension cord with the 110 volt AC power point, since it will defeat the safety protection design. Doing so may cause the power point to overload due to powering multiple devices that can reach beyond the 150 watt load limit and could result in fire or serious injury.

**Note:** *Keep the vehicle running to use the power point.*



E143941

# Auxiliary Power Points

---

You can use the power point for powering electrical devices that require up to 150 watts. It is on the rear of the center console.

When the indicator light, located on the power point, is:

- on — power point is ready to supply power.
- off — power point power supply is off; ignition is not on.
- flashing — power point is in fault mode.

The power point temporarily turns off power if it exceeds the 150 watt limit. It can also switch to a fault mode if it detects overloading, overheating, or shorting conditions. For overloading and shorting conditions, unplug your device and switch the ignition off then on. For an overheating condition, let the system cool off first. Switch the ignition off then on.

Do not use the power point for certain electric devices, including:

- Cathode ray tube type televisions
- Motor loads, for example vacuum cleaners, electric saws and other electric power tools, or compressor-driven refrigerators
- Measuring devices which process precise data, for example medical equipment or measuring equipment
- Other appliances requiring an extremely stable power supply, for example microcomputer-controlled electric blankets or touch sensor lamps

# Storage Compartments

## CENTER CONSOLE

Stow items in the cupholder carefully as items may become loose during hard braking, acceleration or collisions, including hot drinks which may spill.

Available console features include:

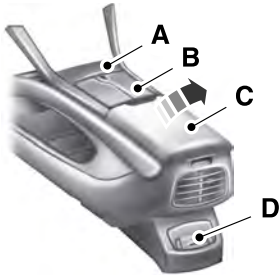

E146582

- A Front storage bin with auxiliary power point
- B Cupholders

- C Storage compartment with auxiliary power point and media hub
- D Auxiliary power point, 110 volt AC power point

## OVERHEAD CONSOLE

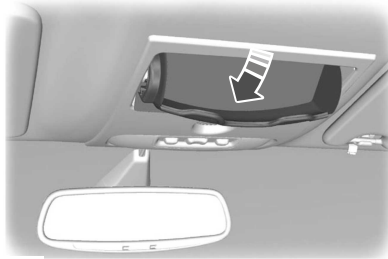

E75193

Press near the rear edge of the door to open it.

# Starting and Stopping the Engine

## GENERAL INFORMATION

### WARNINGS

 Extended idling at high engine speeds can produce very high temperatures in the engine and exhaust system, creating the risk of fire or other damage.

 Do not park, idle or drive your vehicle on dry grass or other dry ground cover. The emission system heats up the engine compartment and exhaust system, creating the risk of fire.

 Do not start the vehicle in a closed garage or in other enclosed areas. Exhaust fumes can be toxic. Always open the garage door before you start the vehicle.

 If you smell exhaust fumes inside your vehicle, have your vehicle checked by an authorized dealer immediately. Do not drive your vehicle if you smell exhaust fumes.

If you disconnect the battery, your vehicle may exhibit some unusual driving characteristics for approximately 5 miles (8 kilometers) after you reconnect it. This is because the engine management system must realign itself with the engine. You can disregard any unusual driving characteristics during this period.

The powertrain control system meets all Canadian interference-causing equipment standard requirements regulating the impulse electrical field or radio noise.

When you start the vehicle, avoid pressing the accelerator pedal before and during operation. Only use the accelerator pedal when you have difficulty starting the vehicle.

## KEYLESS STARTING

**Note:** *The keyless starting system may not function if the key is close to metal objects or electronic devices such as cellular phones.*

**Note:** *A valid key must be located inside your vehicle to switch the ignition on and start the vehicle.*

## Ignition Modes

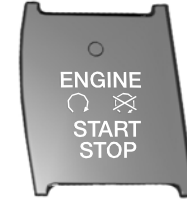

E164319

# Starting and Stopping the Engine

---

The keyless starting system has three modes:

- **Off:** Turns the ignition off.
  - Without applying the brake pedal, press and release the button once when the ignition is in the on mode, or when the vehicle is running but is not moving.
- **On:** All electrical circuits are operational and the warning lamps and indicators illuminate.
  - Without applying the brake pedal, press and release the button once.
- **Start:** Starts the vehicle. The engine may not start when the vehicle starts.
  - Press the brake pedal, and then press the button until the vehicle starts. An indicator light on the button illuminates when then ignition is on and when the vehicle starts.

## STARTING A GASOLINE ENGINE

When the engine starts for the first time on your drive, the idle speed increases, this helps to warm up the engine. If the engine idle speed does not slow down automatically, have your vehicle checked by an authorized dealer.

**Note:** *You can crank the engine for a total of 60 seconds (without the engine starting) before the starting system temporarily disables. The 60 seconds does not have to be all at once. For example, if you crank the engine three times for 20 seconds each time, without the engine starting, you reached the 60-second time limit. A message appears in the information display alerting you that you exceeded the cranking time. You cannot attempt to start the engine for at least 15 minutes. After 15 minutes, you are limited to a 15-second engine cranking time. You need to wait 60 minutes before you can crank the engine for 60 seconds again.*

Before starting the vehicle, check the following:

- Make sure all occupants have fastened their safety belts.
- Make sure the headlamps and electrical accessories are off.
- Make sure the parking brake is on.
- Put the transmission in **P**.

**Note:** *Do not touch the accelerator pedal.*

1. Fully press the brake pedal.
2. Press the button.

**Note:** *The green ready indicator illuminates letting you know that the vehicle is ready for driving. Since your vehicle is equipped with a silent key start, the engine may not start at the time of the vehicle start. See **Hybrid Electric Vehicle** (page 168).*

The system does not function if:

- The key frequencies are jammed.
- The key battery has no charge.

If you are unable to start the vehicle, do the following:

# Starting and Stopping the Engine

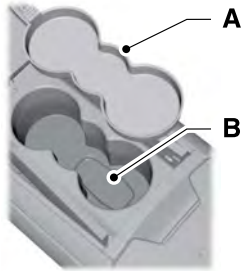

E155835

1. Remove the rubber covering (A) in the cupholder. Place the remote in the backup slot (B) at the bottom of the cupholder.
2. With the key in this position, press the brake pedal, then the START button to switch the ignition on and start your vehicle.

## Fast Restart

The fast restart feature allows you to restart the vehicle within 20 seconds of switching it off, even if a valid key is not present.

Within 20 seconds of switching the vehicle off, press the brake pedal and press the button. After 20 seconds have expired, you can no longer restart the vehicle without the key present inside your vehicle.

Once the vehicle has started, it remains running until you press the button, even if the system does not detect a valid key. If you open and close a door while the vehicle is running, the system searches for a valid key. You cannot restart the vehicle if the system does not detect a valid key within 20 seconds.

## Automatic Shutdown

This feature automatically shuts down the vehicle if it has been idling for an extended period. The ignition also turns off in order to save battery power. Before the vehicle shuts down, a message appears in the information display showing a timer counting down from 30 seconds. If you do not intervene within 30 seconds, the vehicle shuts down. Another message appears in the information display to inform you that the vehicle has shut down in order to save fuel. Start your vehicle as you normally do.

## Automatic Shutdown Override

**Note:** You cannot permanently switch off the automatic shutdown feature. When you switch it off temporarily, it turns on at the next ignition cycle.

You can stop the shutdown, or reset the timer, at any point before the 30-second countdown has expired by doing any of the following:

- You can reset the timer by interacting with your vehicle (such as pressing the brake pedal or accelerator pedal).
- You can temporarily switch off the shutdown feature any time the ignition is on (for the current ignition cycle only). Use the information display to do so. See **Information Displays** (page 109).
- During the countdown before shutdown, you are prompted to press OK or RESET (depending on your type of information display) to temporarily switch the feature off (for the current ignition cycle only).

# Starting and Stopping the Engine

## Switching Off the Vehicle When It Is Stationary

1. Put the transmission in position **P**.
2. Press the button once.
3. Apply the parking brake.

**Note:** This switches off the ignition, all electrical circuits, warning lamps and indicators.

**Note:** If the engine is idling for 30 minutes, the ignition and engine automatically shut down.

## Switching Off the Vehicle When It Is Moving

### WARNING



Switching off the engine when the vehicle is still moving will result in a loss of brake and steering assistance. The steering will not lock, but higher effort will be required. When the ignition is switched off, some electrical circuits, warning lamps and indicators may also be off.

1. Put the transmission in position **N** and use the brakes to bring your vehicle to a safe stop.
2. When your vehicle has stopped, put the transmission in position **P**.
3. Press and hold the button for one second, or press it three times within two seconds.
4. Apply the parking brake.

## Guarding Against Exhaust Fumes

### WARNING



If you smell exhaust fumes inside your vehicle, have your vehicle checked by your authorized dealer immediately. Do not drive your vehicle if you smell exhaust fumes. Carbon monoxide is present in exhaust fumes. Take precautions to avoid its dangerous effects.

## Important Ventilating Information

If you stop your vehicle and leave the engine idling for long periods of time, we recommend that you do one of the following:

- Open the windows at least 1 inch (2.5 centimeters)
- Set your climate control to outside air.

## ENGINE BLOCK HEATER (If Equipped)

### WARNINGS



Failure to follow engine block heater instructions could result in property damage or serious personal injury.



Do not use your heater with ungrounded electrical systems or two-pronged adapters. There is a risk of electrical shock.

**Note:** The heater is most effective when outdoor temperatures are below 0°F (-18°C).

The heater acts as a starting aid by warming the engine coolant. This allows the climate control system to respond quickly. The equipment includes a heater element (installed in the engine block) and a wire harness. You can connect the system to a grounded 120-volt AC electrical source.

# Starting and Stopping the Engine

---

We recommend that you do the following for a safe and correct operation:

- Use a 16-gauge outdoor extension cord that is product certified by Underwriter's Laboratory (UL) or Canadian Standards Association (CSA). This extension cord must be suitable for use outdoors, in cold temperatures, and be clearly marked Suitable for Use with Outdoor Appliances. Do not use an indoor extension cord outdoors. This could result in an electric shock or become a fire hazard.
- Use as short an extension cord as possible.
- Do not use multiple extension cords.
- Make sure that when in operation, the extension cord plug and heater cord plug connections are free and clear of water. This could cause an electric shock or fire.
- Make sure your vehicle is parked in a clean area, clear of combustibles.
- Make sure the heater, heater cord and extension cord are firmly connected.

- Check for heat anywhere in the electrical hookup once the system has been operating for approximately 30 minutes.
- Make sure the system is unplugged and properly stowed before driving your vehicle. Make sure the protective cover seals the prongs of the block heater cord plug when not in use.
- Make sure the heater system is checked for proper operation before winter.

## Using the Engine Block Heater

Make sure the receptacle terminals are clean and dry prior to use. Clean them with a dry cloth if necessary.

The heater uses 0.4 to 1.0 kilowatt-hours of energy per hour of use. The system does not have a thermostat. It achieves maximum temperature after approximately three hours of operation. Using the heater longer than three hours does not improve system performance and unnecessarily uses electricity.

# Unique Driving Characteristics

## HYBRID ELECTRIC VEHICLE

This hybrid vehicle combines electric and gasoline propulsion to provide performance and efficiency. It requires no special fuels and you never have to plug it in.

**Note:** *You may notice higher engine speeds upon start-up. This temporary condition is normal and necessary to heat up the cabin and minimize emissions.*



**Starting:** Switch the ignition on while your transmission is in park (P). The green ready indicator light will appear in the instrument cluster, letting you know that the vehicle is ready for driving.

The engine may not start because this vehicle is equipped with silent key start. This fuel saving feature allows your vehicle to be ready to drive without requiring the gas engine to be running. This indicator will remain on while the vehicle is on, whether

the engine is running or not to indicate the vehicle is capable of movement (using its electric motor, engine, or both). Typically, the engine will not start unless the vehicle is cold, you make a climate control change, or you press the accelerator.

**Driving:** The gas engine automatically starts and stops to provide power when needed and to save fuel when not needed. While coasting at low speeds, coming to a stop, or standing, the gas engine normally shuts down and the vehicle operates in electric-only mode. Conditions that may cause the engine to start up or remain running include:

- Considerable vehicle acceleration.
- Vehicle speed above 85 mph (137 km/h) However, the maximum speed for electric-only operation may be lower while driving in hot temperatures or on hilly terrain.
- Ascending a hill.
- Charge level of high voltage battery is low.

- Very high or low outside temperature (to provide system cooling or heating).
- Engine not warm enough to provide passenger requested cabin temperature.

**Stopping:** The gas engine may shut off to conserve fuel as you come to a stop. Restarting the vehicle is not required. Simply step on the accelerator when you are ready to drive.

**Transmission Operation:** Due to the technologically advanced, electronically-controlled continuously variable transaxle, you will not feel shift changes like those of a non-hybrid vehicle.

**Note:** *Since engine speed is controlled by the transmission, it may seem elevated at times. This is normal hybrid operation and helps deliver fuel efficiency and performance.*

**Neutral:** It is not recommended to idle the vehicle in neutral (N) for an extended period of time because this will discharge your high voltage battery and decrease fuel economy. The engine will not start, and cannot provide power to the hybrid system in neutral (N).

# Unique Driving Characteristics

---

**Low Gear:** Low gear (L) is designed to mimic the enhanced engine braking available in non-hybrid vehicles. Low gear will produce high engine speeds to provide necessary engine braking. This is normal and will not damage your vehicle. In low gear, the gas engine will remain on more often than in drive (D).

## Unique Hybrid Operating Characteristics

Your vehicle behaves differently compared to a non-hybrid. Here is a description of the major differences:

**Battery:** Your Hybrid is equipped with a high voltage battery. A cool battery ensures battery life and provides the best possible performance. Your hybrid high voltage battery may periodically re-condition itself to ensure maximum efficiency. You may notice slight changes in driveability during this process, but it is an important part of your hybrid's high voltage battery optimization features.

Cabin air cools the high voltage battery by pulling air through vents in the rear package tray. Avoid placing objects on the package tray which could block air flow through the vents.

If you leave your vehicle inoperative for over 31 days, it may be necessary to jumpstart the vehicle. See **Roadside Emergencies** (page 252).

**Engine:** The engine speed in your hybrid is not directly tied to your vehicle speed. Your vehicle's engine and transmission are designed to deliver the power you need at the most efficient engine speed. During heavy accelerations, your hybrid may reach high engine speeds (up to 6000 RPM).

In prolonged mountainous driving, you may see the engine tachometer changing without your input. This is intentional and maintains the battery charge level. You may also notice during extended downhill driving that your engine continues to run instead of shutting off.

During this engine braking, the engine stays on, but it is not using any fuel. You may also hear a slight whine or whistle when operating your vehicle. This is the normal operation of the electric generator in the hybrid system.

During certain events (such as vehicle servicing) your low voltage 12-volt battery may become disconnected or disabled. Once the battery is reconnected and after driving the vehicle, the engine may continue to operate for three to five seconds after the key is turned to off. This is a normal condition.

**Braking:** Your hybrid is equipped with standard hydraulic braking and regenerative braking. Regenerative braking is performed by your transmission and it captures brake energy and stores it in your high voltage battery.

## Driving to optimize fuel economy

**Note:** *Having your engine running is not always an indication of inefficiency. In some cases, it is actually more efficient than driving in electric mode.*

# Unique Driving Characteristics

---

Your fuel economy should improve throughout your hybrid's break-in period. As with any vehicle, your driving habits and accessory usage can significantly impact your fuel economy. For best results, keep in mind these tips:

- Keep the tires properly inflated and only use the recommended size.
- Aggressive driving increases the amount of energy required to move your vehicle. In general, you can achieve better fuel economy with mild to moderate acceleration and deceleration. Moderate braking is particularly important since it allows you to maximize the energy captured by the regenerative braking system.

Additional Tips:

- Do not carry extra loads.
- Be mindful of adding external accessories that may increase aerodynamic drag.
- Observe posted speed limits.
- Perform all scheduled maintenance.
- There is no need to wait for your engine to warm up. The vehicle is ready to drive immediately after starting.

## EV+ Mode

Your vehicle will recognize your frequent destinations and allow for more EV driving as you approach them. For example, when nearing your home it should be easier to stay in electric mode. The EV indicator will display EV+ when this mode is active. You should see this about 1/8 mile (200 meters) from a frequent destination. See **Information Displays** (page 109).

**Note:** *Frequent destinations are learned by your vehicle after two to four weeks of use. You can clear these destinations with a Driving History reset through the Settings menu.*

**Note:** *The EV+ feature can be turned on or off through the Driver Assist section of the Settings menu.*

# Unique Driving Characteristics

## Frequently asked questions

Question	Answer
What are the series of clicks from the cargo area when I first turn the key in the ignition?	The high voltage battery is electrically isolated from the rest of the vehicle when the key is off. When you turn the key to on, high voltage contactors inside the battery are closed to make the electricity available to the motor/generator and enable the vehicle to drive. The clicks are the sound of these contactors as they close and open during start up and shut down.
Why does the engine sometimes start at key-on?	The vehicle's computer will determine if an engine start is required at key-on. Silent key start will start the engine if it is necessary for cabin heating, windshield defrost, or if the outside temperature is low.
Why does it take a long time before the engine shuts down?	There are several reasons the engine stays on for an extended amount of time when you first start it. One common reason is to ensure that the emissions components are warm enough to minimize tailpipe emissions. As the climate gets cooler, this engine-on time is extended.
Why does my engine never shut down above 85 mph (137 km/h)?	The engine is required to turn on above this speed to protect the transmission hardware.
Why does my engine stay on when it is extremely cold outside?	In order to ensure that the climate control system can begin heating the cabin or defrosting the windshield as soon as a driver requests it, the engine coolant temperature has to be kept sufficiently hot. Keeping the engine on is required to maintain the correct minimum temperature.

## Unique Driving Characteristics

Question	Answer
Why does my engine rev up so high sometimes when I accelerate?	Your vehicle's engine and transmission are designed to deliver the power you need at the most efficient engine speed. This may be higher than expected during heavy accelerations, and may fluctuate during steady state driving. These are characteristics of the Atkinson engine cycle and the transmission technology that help maximize your hybrid's fuel economy.
What is the fan noise I hear from the rear of my hybrid?	The fan noise comes from a fan located outside the high voltage battery. This fan turns on when the battery requires cooling air. The fan speed, and associated noise level, will change according to the amount of cooling required to maintain good performance. Maintaining the battery temperature at optimal conditions also prolongs the useful life of the battery and helps to achieve better fuel economy. Do not place objects on the package tray which could block air flow through the hybrid vehicle battery cooling vents.
How far can I go in Electric Drive if I run out of gas?	Running out of gas is not recommended. However, you may be able to go about one mile, driving at 30 mph (48 km/h), if the battery has a normal state of charge.
What is the engine oil change service interval?	Change the engine oil every 10000 miles (16000 km) under normal operating conditions. See <b>Scheduled Maintenance</b> (page 468).
Can I put E15 or E85 in my vehicle, and how will it affect my fuel economy?	Your hybrid vehicle can use E15 (15% ethanol, 85% gasoline) fuel, but you may notice slightly reduced fuel economy because ethanol contains less energy per gallon than gasoline. Your hybrid vehicle is not designed to use E85 (85% ethanol).

## Unique Driving Characteristics

---

Question	Answer
How long will my high voltage battery last? Does it need maintenance?	The high voltage battery system is designed to last the life of the vehicle and requires no maintenance.
Can you charge the battery with a plug into an A/C outlet?	There are no provisions for charging the high voltage battery from a power supply external to the vehicle.
Can I tow the hybrid behind my motor home with all four wheels down?	Yes. Your hybrid vehicle can be flat towed without modification. See <b>Towing</b> (page 247).

# Fuel and Refueling

## SAFETY PRECAUTIONS

### WARNINGS

 Do not overfill the fuel tank. The pressure in an overfilled tank may cause leakage and lead to fuel spray and fire.

 The fuel system may be under pressure. If you hear a hissing sound near the fuel filler door (Easy Fuel capless fuel system), do not refuel until the sound stops. Otherwise, fuel may spray out, which could cause serious personal injury.

 Automotive fuels can cause serious injury or death if misused or mishandled.

 Flow of fuel through a fuel pump nozzle can produce static electricity. This can cause a fire if you are filling an ungrounded fuel container.

 Fuel ethanol and gasoline may contain benzene, which is a cancer-causing agent.

### WARNINGS

 When refueling always shut the engine off and never allow sparks or open flames near the filler neck. Never smoke or use a cell phone while refueling. Fuel vapor is extremely hazardous under certain conditions. Avoid inhaling excess fumes.

Observe the following guidelines when handling automotive fuel:

- Extinguish all smoking materials and any open flames before refueling your vehicle.
- Always turn off the vehicle before refueling.
- Automotive fuels can be harmful or fatal if swallowed. Fuel such as gasoline is highly toxic and if swallowed can cause death or permanent injury. If fuel is swallowed, call a physician immediately, even if no symptoms are immediately apparent. The toxic effects of fuel may not be visible for hours.

- Avoid inhaling fuel vapors. Inhaling too much fuel vapor of any kind can lead to eye and respiratory tract irritation. In severe cases, excessive or prolonged breathing of fuel vapor can cause serious illness and permanent injury.
- Avoid getting fuel liquid in your eyes. If fuel is splashed in the eyes, remove contact lenses (if worn), flush with water for 15 minutes and seek medical attention. Failure to seek proper medical attention could lead to permanent injury.

# Fuel and Refueling

---

- Fuels can also be harmful if absorbed through the skin. If fuel is splashed on the skin, clothing or both, promptly remove contaminated clothing and wash skin thoroughly with soap and water. Repeated or prolonged skin contact with fuel liquid or vapor causes skin irritation.
- Be particularly careful if you are taking “Antabuse” or other forms of disulfiram for the treatment of alcoholism. Breathing gasoline vapors, or skin contact could cause an adverse reaction. In sensitive individuals, serious personal injury or sickness may result. If fuel is splashed on the skin, promptly wash skin thoroughly with soap and water. Consult a physician immediately if you experience an adverse reaction.

## FUEL QUALITY

**Note:** *We recommend that you use only high quality fuel without additives or other engine treatments.*

## Choosing the Right Fuel

**Note:** *Use of any fuel other than those recommended may cause powertrain damage, a loss of vehicle performance and repairs may not be covered under warranty.*

If your vehicle is not a flexible fuel vehicle, then only use unleaded fuel or unleaded fuel blended with a maximum of 15% ethanol. Do not use fuel ethanol (E85), diesel fuel, fuel methanol, leaded fuel or any other fuel because it could damage or impair the emission control system.

The use of leaded fuel is prohibited by law.

Your vehicle was not designed to use fuel or fuel additives with metallic compounds, including manganese-based additives.

## Octane Recommendations

Regular unleaded gasoline with a pump (R+M)/2 octane rating of 87 is recommended. Some fuel stations offer fuels posted as regular with an octane rating below 87, particularly in high altitude areas. Fuels with octane levels below 87 are not recommended. Premium fuel will provide improved performance and is recommended for severe duty use such as trailer tow.

Do not be concerned if your engine sometimes knocks lightly. However, if it knocks heavily while you are using fuel with the recommended octane rating, see your authorized dealer to prevent any engine damage.

## RUNNING OUT OF FUEL

Avoid running out of fuel because this situation may have an adverse effect on vehicle components.

If you have run out of fuel:

# Fuel and Refueling

---

- To start the vehicle with a keyless ignition, just start the engine. Crank time will be longer than usual.
- Normally, adding 1 gallon (3.8 liters) of fuel is enough to restart the vehicle. If the vehicle is out of fuel and on a steep grade, more than 1 gallon (3.8 liters) may be required.
- The service engine soon indicator may come on.

## Refilling With a Portable Fuel Container

### WARNINGS



Do not insert the nozzle of portable fuel containers or aftermarket funnels into the capless fuel system. This could damage the fuel system and its seal, and may cause fuel to run onto the ground instead of filling the tank, which could result in serious personal injury.



Do not try to pry open or push open the capless fuel system with foreign objects. This could damage the fuel system and its seal and cause injury to you or others.

**Note:** *Do not use aftermarket funnels; they will not work with the capless fuel system and can damage it. The included funnel has been specially designed to work safely with your vehicle.*

When filling the vehicle's fuel tank from a portable fuel container, use the funnel included with the vehicle.

# Fuel and Refueling

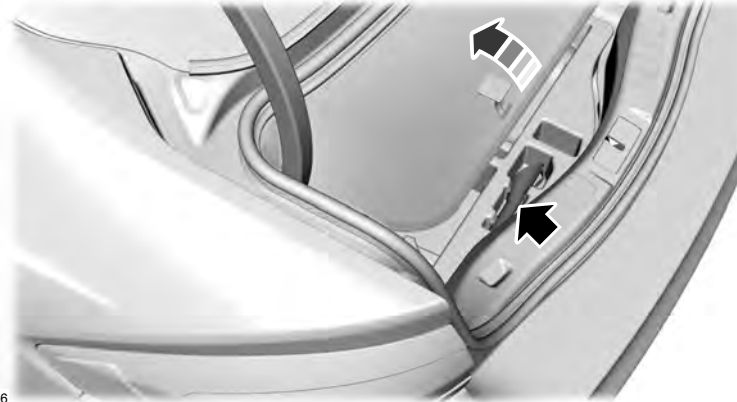

E163066

The funnel is located in the rear of the vehicle, inside the load compartment, underneath the load floor carpet and is accessible from the trunk.

1. Locate the portable funnel that comes with your vehicle.

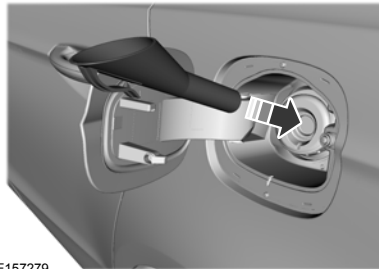

E157279

2. Slowly insert the funnel into the capless fuel system.

# Fuel and Refueling

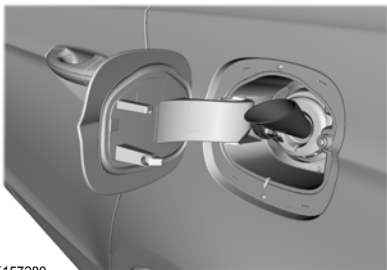



E157280







3. Fill the vehicle with fuel from the portable fuel container.
4. When done, clean the funnel or properly dispose of it. Extra funnels can be purchased from your authorized dealer if you choose to dispose of the funnel.

## REFUELING

### WARNINGS

-  Fuel vapor burns violently and a fuel fire can cause severe injuries.
-  Read and follow all the instructions on the pump island.

### WARNINGS

-  Switch off your engine when you are refueling.
-  Do not smoke if you are near fuel or refueling your vehicle.
-  Keep sparks, flames and smoking materials away from fuel.
-  Stay outside your vehicle and do not leave the fuel pump unattended when refueling your vehicle. This is against the law in some places.
-  Keep children away from the fuel pump; never let children pump fuel.
-  Do not use personal electronic devices while refueling.

Use the following guidelines to avoid electrostatic charge build-up when filling an ungrounded fuel container:

- Place approved fuel container on the ground.
- Do not fill a fuel container while it is in your vehicle (including the cargo area).

- Keep the fuel pump nozzle in contact with the fuel container while filling.
- Do not use a device that would hold the fuel pump handle in the fill position.

### Easy Fuel™ Capless Fuel System

#### WARNING

-  The fuel system may be under pressure. If you hear a hissing sound near the fuel filler door, do not refuel until the sound stops. Otherwise, fuel may spray out, which could cause serious personal injury.

When fueling your vehicle:

1. Put the vehicle in position **P** and switch the ignition off.

# Fuel and Refueling

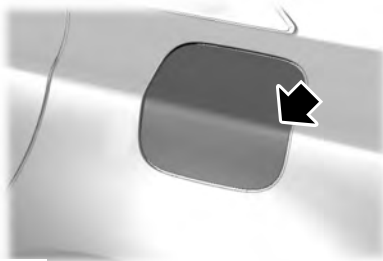

E166527

2. Press the center-rear edge of the fuel filler door and release to open.

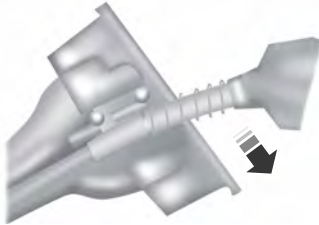

E156032

**Note:** Hold the handle of the fuel filler nozzle higher while you insert the nozzle for easier access.

3. Slowly insert the fuel filler nozzle fully into the fuel system to open both doors. Leave the nozzle fully inserted until you have stopped pumping fuel.

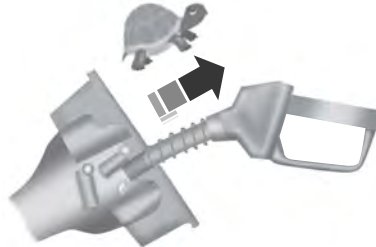

E154765

**Note:** Allow about five to ten seconds after pumping fuel before removing the fuel filler nozzle. This allows residual fuel to drain back into the fuel tank and not spill onto the vehicle.

4. After you have stopped pumping fuel, slowly remove the fuel filler nozzle.

**Note:** A fuel spillage concern may occur if overfilling the fuel tank. Do not overfill the tank to the point that the fuel is able to bypass the fuel filler nozzle. The overfilled fuel may run down the drain located below and in front of the fuel filler door.

5. To close the fuel filler door, press the center-rear edge of the fuel filler door and then release. The fuel door will latch closed.

If the fuel fill inlet did not close properly, a **Check Fuel Fill Inlet** message may appear on the instrument cluster.

At the next opportunity, do the following:

1. Safely pull off the road.
2. Put the vehicle in position **P** and switch the ignition off.
3. Open the fuel filler door and remove any visible debris from the fuel fill opening.
4. Insert the fuel fill nozzle, or the fuel fill funnel provided with the vehicle, several times to allow the inlet to close properly. This will dislodge any debris preventing the inlet from sealing.

# Fuel and Refueling

---

If this action corrects the problem, the message may not reset immediately. It may take several driving cycles for the message to turn off. A driving cycle consists of an engine start-up (after four or more hours with the engine off) followed by city or highway driving. Continuing to drive with the message on may cause the service engine soon lamp to turn on as well.

## FUEL CONSUMPTION

**Note:** *The amount of usable fuel in the empty reserve varies and should not be relied upon to increase driving range. When refueling your vehicle after the fuel gauge indicates empty, you might not be able to refuel the full amount of the advertised capacity of the fuel tank due to the empty reserve still present in the tank.*

Empty reserve is the amount of fuel remaining in the tank after the fuel gauge indicates empty. Do not rely on this fuel for driving. The usable capacity of the fuel tank is the amount of fuel that can be put into the tank after the gauge indicates empty. The advertised capacity is the total fuel tank size – it is the combined usable capacity plus the empty reserve.

## Filling the Tank

For consistent results when filling the fuel tank:

- Turn the ignition off before fueling; an inaccurate reading results if the engine is left running.
- Use the same fill rate (low-medium-high) each time the tank is filled.
- Allow no more than two automatic click-offs when filling.

Results are most accurate when the filling method is consistent.

## Calculating Fuel Economy

Do not measure fuel economy during the first 1000 miles (1600 kilometers) of driving (this is your engine's break-in period); a more accurate measurement is obtained after 2000 miles - 3000 miles (3200 kilometers - 4800 kilometers). Also, fuel expense, frequency of fill ups or fuel gauge readings are not accurate ways to measure fuel economy.

1. Fill the fuel tank completely and record the initial odometer reading.
2. Each time you fill the tank, record the amount of fuel added.
3. After at least three to five tank fill ups, fill the fuel tank and record the current odometer reading.
4. Subtract your initial odometer reading from the current odometer reading.
5. Calculate fuel economy by dividing miles traveled by gallons used (For Metric: Multiply liters used by 100, then divide by kilometers traveled).

# Fuel and Refueling

Keep a record for at least one month and record the type of driving (city or highway). This provides an accurate estimate of the vehicle's fuel economy under current driving conditions. Additionally, keeping records during summer and winter show how temperature impacts fuel economy. In general, lower temperatures mean lower fuel economy.

## EMISSION CONTROL SYSTEM

### WARNINGS



Do not park, idle, or drive your vehicle in dry grass or other dry ground cover. The emission system heats up the engine compartment and exhaust system, which can start a fire.



Exhaust leaks may result in entry of harmful and potentially lethal fumes into the passenger compartment. If you smell exhaust fumes inside your vehicle, have your dealer inspect your vehicle immediately. Do not drive if you smell exhaust fumes.

Your vehicle is equipped with various emission control components and a catalytic converter that will enable your vehicle to comply with applicable exhaust emission standards. To make sure that the catalytic converter and other emission control components continue to work properly:

- Use only the specified fuel listed.
- Avoid running out of fuel.
- Do not turn off the ignition while your vehicle is moving, especially at high speeds.
- Have the items listed in scheduled maintenance information performed according to the specified schedule.

The scheduled maintenance items listed in scheduled maintenance information are essential to the life and performance of your vehicle and to its emissions system.

If you use parts other than Ford, Motorcraft or Ford-authorized parts for maintenance replacements, or for service of components affecting emission control, such non-Ford parts should be the equivalent to genuine Ford Motor Company parts in performance and durability.

Illumination of the service engine soon indicator, charging system warning light or the temperature warning light, fluid leaks, strange odors, smoke or loss of engine power could indicate that the emission control system is not working properly.

An improperly operating or damaged exhaust system may allow exhaust to enter the vehicle. Have a damaged or improperly operating exhaust system inspected and repaired immediately.

Do not make any unauthorized changes to your vehicle or engine. By law, vehicle owners and anyone who manufactures, repairs, services, sells, leases, trades vehicles, or supervises a fleet of vehicles are not permitted to intentionally remove an emission control device or prevent it from working. Information about your vehicle's emission system is on the Vehicle Emission Control Information Decal located on or near the engine. This decal also lists engine displacement

Please consult your warranty information for complete details.

# Fuel and Refueling

## On-Board Diagnostics (OBD-II)

Your vehicle is equipped with an on-board diagnostics system (OBD-II) that monitors the engine's emission control system. This system protects the environment by ensuring that your vehicle continues to meet government emission standards. The OBD-II system also assists your authorized dealer in properly servicing your vehicle.



When the service engine soon indicator illuminates, the OBD-II system has detected a malfunction. Temporary malfunctions may cause the service engine soon indicator to illuminate.

Examples of temporary malfunctions are:

- the vehicle has run out of fuel—the engine may misfire or run poorly
- poor fuel quality or water in the fuel—the engine may misfire or run poorly
- the fuel fill inlet may not have been properly closed See **Refueling** (page 178).
- driving through deep water—the electrical system may be wet.

You can correct these temporary malfunctions by filling the fuel tank with good quality fuel, properly closing the fuel fill inlet or letting the electrical system dry out. After three driving cycles without these or any other temporary malfunctions present, the service engine soon indicator should stay off the next time you start the engine. A driving cycle consists of a cold engine startup followed by mixed city/highway driving. No additional vehicle service is required.

If the service engine soon indicator remains on, have your vehicle serviced at the first available opportunity. Although some malfunctions detected by the OBD-II may not have symptoms that are apparent, continued driving with the service engine soon indicator on can result in increased emissions, lower fuel economy, reduced engine and transmission smoothness, and lead to more costly repairs.

## Readiness for Inspection/Maintenance (I/M) Testing

Some state/provincial and local governments may have Inspection/Maintenance (I/M) programs to inspect the emission control equipment on your vehicle. Failure to pass this inspection could prevent you from getting a vehicle registration.



If the service engine soon indicator is on or the bulb does not work, you may need to have the vehicle serviced. See On-Board Diagnostics (OBD-II).

Your vehicle may not pass the I/M test if the service engine soon indicator is on or not working properly (bulb is burned out), or if the OBD-II system has determined that some of the emission control systems have not been properly checked. In this case, your vehicle is not ready for I/M testing.

If the vehicle's engine or transmission has just been serviced, or the battery has recently run down or been replaced, the OBD-II system may indicate that the vehicle is not ready for I/M testing. To determine if the vehicle is ready for I/M testing, turn the

# Fuel and Refueling

---

ignition key to the on position for 15 seconds without cranking the engine. If the service engine soon indicator blinks eight times, it means that the vehicle is not ready for I/M testing; if the service engine soon indicator stays on solid, it means that the vehicle is ready for I/M testing.

The OBD-II system monitors the emission control system during normal driving. A complete check may take several days. If the vehicle is not ready for I/M testing, you may need to perform the following driving cycle consisting of mixed city and highway driving:

Drive on an expressway or highway for a steady 15 minutes, followed by 20 minutes of stop-and-go driving with at least four 30-second idle periods.

Allow the vehicle to sit for at least eight hours without starting the engine. Then, start the engine and complete the above driving cycle. The engine must warm up to its normal operating temperature. Once started, do not turn off the engine until the above driving cycle is complete. If the vehicle is still not ready for I/M testing, you will have to repeat the above driving cycle.

# High Voltage Battery

## GENERAL INFORMATION

### WARNING



This battery pack should only be serviced by an authorized electric vehicle technician. Improper handling can result in personal injury or death.

**Note:** *The high voltage battery does not require regular service maintenance.*

Your vehicle consists of various high voltage components and wiring. All of the high voltage power flows through specific wiring assemblies which are labeled as such or that are covered with a solid orange convolute, orange striped tape or both. Do not come in contact with these components.

The high voltage battery system is a high voltage, lithium-ion battery system. The pack is located in the rear cargo area. The high voltage battery system uses an air-cooled system to regulate the high voltage battery temperature and help maximize high voltage battery life.

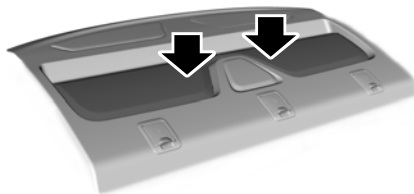

E159505

**Note:** *The high voltage battery is equipped with air vents in the package tray that help to regulate its temperature. It is important to keep these openings free of obstructions. Do not block the flow of cabin air to this area.*

## HIGH VOLTAGE SERVICE DISCONNECT

The high voltage service disconnect turns off power from the high voltage battery.

There is a disconnect circuit in your vehicle. Disconnecting the circuit will automatically disable the high voltage battery.

To disable the battery and stop all high voltage electric activity in the vehicle, you can access the high voltage disconnect circuit. To do this, you must unplug the circuit from the circuit port connected to the battery.

The service disconnect is equipped with an outer lever. This is to aid in properly seating the service disconnect lever. Remove this to disconnect the high voltage service disconnect.

The high voltage service disconnect is located behind the rear fold down seats.

### Disabling the High Voltage Battery

1. Fold down the rear seats.
2. Locate the access door and remove the plastic cover.

# High Voltage Battery

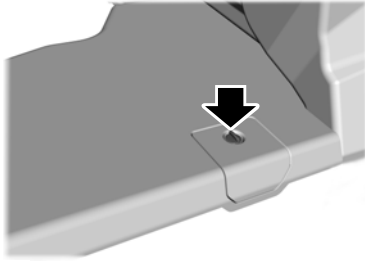

E159506

3. Pull the outer cover off to expose the service disconnect lever.

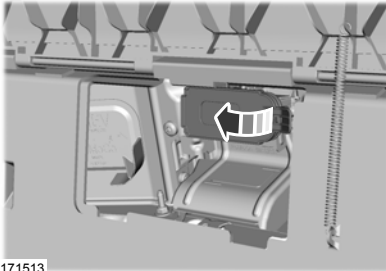

E171513

4. Slide the handle on the service disconnect outboard to the right.

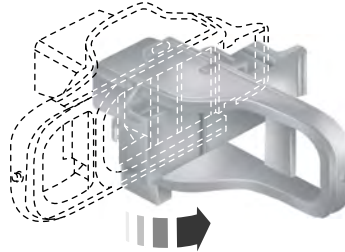

E147234

5. Pull the handle toward you and remove the circuit from the vehicle to disable the high voltage battery.

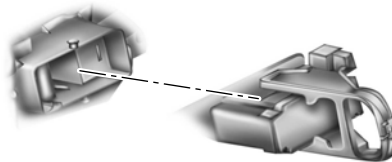

E146133

6. Reverse this procedure to reinstall the high-voltage service disconnect and the outer lever to the service disconnect.

## Reactivating the High Voltage Battery

**Note:** If you have manually disconnected your high voltage shut off circuit, you need to reconnect the circuit before you can reactivate it. The vehicle will detect if the electrical system is safe and reactivate automatically.

## HIGH VOLTAGE BATTERY CUT-OFF SWITCH

The high-voltage shut off operation shuts off power from the high-voltage battery after a collision, or if your vehicle receives a substantial physical jolt.

To reactivate your vehicle after either event, perform the following steps:

1. Turn the ignition off.
2. Turn the ignition on.

# High Voltage Battery

---

3. If your vehicle is not powered after this sequence, repeat steps 1 and 2 up to two more times.

For vehicles equipped with a push button start system:

1. Press the **START/STOP** button to turn ignition off.
2. Press the brake pedal and press the **START/STOP** button.
3. If your vehicle is not powered after this sequence, repeat steps 1 and 2 up to two more times.

**Note:** *During this process, your vehicle will detect if the electrical system is safe and reactivate. Once your vehicle determines the electrical system safe, you can start your vehicle as you would normally by either turning the ignition key or by pressing the brake in combination with the **START/STOP** button.*

**Note:** *In the event your vehicle does not reactivate after the third key cycle, contact an authorized dealer.*

# Transmission

## AUTOMATIC TRANSMISSION

### WARNINGS



Always set the parking brake fully and make sure your vehicle is in park (P). Turn the ignition off whenever you leave your vehicle.



Do not apply the brake pedal and accelerator pedal simultaneously. Applying both pedals simultaneously for more than three seconds will limit engine rpm, which may result in difficulty maintaining speed in traffic and could lead to serious injury.

### Push Button Shift Transmission

Your vehicle is equipped with an electronic transmission. The shift buttons are located on the instrument panel, next to the MyLincoln Touch™ system. Select the gears by pressing and releasing the **PRNDL** buttons.



E146131

Every time you select a gear, the selected button will light up. You will also see the gear selected appear in the instrument cluster.

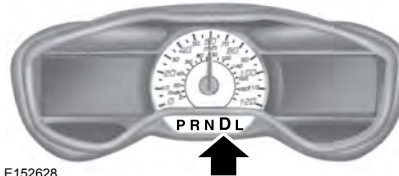

E152628

### Understanding the Positions of your Electronic Transmission

**Note:** Always come to a complete stop before putting your vehicle into and out of park (P).

### Putting your vehicle in gear:

1. Fully press down the brake pedal.
2. Press and release the button on the instrument panel of the gear you want to select.
3. The gear shift button you select will illuminate and the instrument cluster will show the selected gear.
4. Release the brake pedal and your transmission will remain in the selected gear.

# Transmission

---

**Note:** If the driver attempts to leave the vehicle while it is in gear, the vehicle will automatically shift into park (P). Seatbelt and door monitors determine the driver's intent and makes the shift for you. During this time a **Transmission not in Park** message will appear in the display screen, prompting the driver to make the shift. To put the vehicle in gear with the door open perform steps 1-4. See the **Automatic Return to Park** section in this chapter for more information on this feature.

**Note:** To put your vehicle in gear with the door open, perform steps 1-4. See the **Automatic Return to Park** section in this chapter for more information on this feature.

## Park (P)

This position locks the transmission and prevents the front wheels from turning. Always come to a complete stop before putting your vehicle into and out of park (P). An audible chime will sound when park (P) is manually selected.

When you turn the ignition off, your vehicle will automatically shift into park (P). If you turn the ignition off while your vehicle is moving, it will first shift into neutral (N) until a slow enough speed is reached. Your vehicle will then shift into park (P) automatically.

## Automatic Return to Park

**Note:** This feature will not operate when your vehicle is in Stay in Neutral mode or neutral tow.

Your vehicle has a safety feature that will automatically shift your vehicle into park (P) when any of the following circumstances are met:

- Turn the ignition off.
- Open the driver's door with your seat belt unlatched.
- Unlatching your seatbelt while the driver's door is open.

If you turn the ignition off while your vehicle is moving, your vehicle will first shift into neutral (N) until it slows down enough to shift into park (P) automatically.

**Note:** If you have waited an extended period of time, (2-15 minutes) before starting your vehicle, unlatching your safety belt will cause this feature to activate, even with the driver's door closed.

**Note:** This feature may not work properly if the door ajar switch is malfunctioning. If your door ajar indicator does not illuminate when you open the driver's door or the indicator illuminates with the driver's door closed. See your authorized dealer.

## Reverse (R)

With the transmission in reverse (R), your vehicle will move backward. Always come to a complete stop before shifting into and out of reverse (R).

## Neutral (N)

Press the neutral (N) button to put your vehicle in neutral. In neutral, your vehicle can start and is free to roll. Hold the brake pedal down while in this position.

# Transmission

## Stay in Neutral mode

Stay in Neutral mode allows your vehicle to stay in neutral when you exit your vehicle. Your vehicle must be stationary to enter this mode.

To enter Stay in Neutral mode:

1. Press the neutral (N) button on the shifter assembly.
2. The message **Select N Again to Enter Stay in Neutral mode** will appear in the information display screen.
3. Press the neutral (N) button again to enter Stay in Neutral mode.

The message **Stay in Neutral mode engaged** will appear in the instrument cluster when your vehicle has entered Stay in Neutral mode.

**Note:** *During this mode the neutral (N) button will flash continuously and the instrument cluster will display neutral as the selected gear.*

## Exiting Stay in Neutral mode

To disable Stay in Neutral mode put your vehicle in another gear. See the **Putting the Vehicle in Gear** section for instructions on how to do this.

## Entering a Carwash

**Note:** *Always put your vehicle in Stay in Neutral mode when entering an automatic car wash. Failure to do this could result in vehicle damage that may not be covered by warranty.*

## Drive (D)

The normal driving position for the best fuel economy.

## Drive (D) with Grade Assist



The grade assist button is located on the instrument panel next the MyLincoln Touch™ system. Press the grade assist button to activate and deactivate grade assist.

## Grade assist:

- Provides additional grade braking with a combination of engine motoring and high-voltage battery charging to help maintain vehicle speed when descending a grade.
- As your vehicle determines the amount of engine motoring and high-voltage battery charging, you may notice the engine speed increasing and decreasing to help maintain your vehicle speed when descending a grade.



The grade assist lamp will appear in the instrument cluster when grade assist is turned on.

## Low (L)

- Provides maximum engine braking.
- The transmission may be put into low (L) at any vehicle speed.
- Not intended for use under extended or normal driving conditions and results in lower fuel economy.

# Transmission

## Brake-Shift Interlock Override

### WARNINGS

 Do not drive your vehicle until you verify that the brake lamps are working.

 When doing this procedure, you will be taking your vehicle out of park which means your vehicle can roll freely. To avoid unwanted vehicle movement, always fully set the parking brake prior to doing this procedure. Use wheel chocks if appropriate.

 If you fully release the parking brake, but the brake warning lamp remains illuminated, the brakes may not be working properly. See your authorized dealer.

**Note:** See your authorized dealer as soon as possible if this procedure is used.

**Note:** For some markets this feature will be disabled.

**Note:** This feature will only function if your 12-volt battery has power.

Use the brake-shift interlock override procedure to put your vehicle in gear in the event of an electrical malfunction or if your vehicle has a dead battery. The brake shift interlock override button is located inside of the center console, below media inputs. You will need a tool (for example a screwdriver or similar tool) to access the button.

1. Apply the parking brake and turn the ignition off before performing this procedure.



E152215

2. Locate the brake shifter interlock access slot. The slot is located below the media hub, in the front of the center console storage bin and it is not labeled.

**Note:** Make sure that you correctly identify the access hole as not to damage the media hub.

3. Using a tool, press and hold the brake shift interlock switch. When the instrument panel buttons flash, your vehicle is in override mode.
4. With the override switch still held, press the neutral (N) button for towing, or the desired gear to shift from Park.
5. Release the override button.
6. Your vehicle will remain in Stay in Neutral mode for wrecker towing purposes or can be shifted to the desired gear and driven (if your vehicle can be driven).
7. Release the parking brake.

## If Your Vehicle Gets Stuck In Mud or Snow

**Note:** Do not rock your vehicle if the engine is not at normal operating temperature or damage to the transmission may occur.

**Note:** Do not rock your vehicle for more than a minute or damage to the transmission and tires may occur, or the engine may overheat.

# Transmission

---

If your vehicle gets stuck in mud or snow, you may be able to rock it out by shifting between forward and reverse gears, stopping between shifts in a steady pattern. Press lightly on the accelerator in each gear.

# Brakes

## GENERAL INFORMATION

**Note:** Occasional brake noise is normal. If a metal-to-metal, continuous grinding or continuous squeal sound is present, the brake linings may be worn-out. Have the system checked by an authorized dealer. If the vehicle has continuous vibration or shudder in the steering wheel while braking, have it checked by an authorized dealer.

**Note:** Brake dust may accumulate on the wheels, even under normal driving conditions. Some dust is inevitable as the brakes wear and does not contribute to brake noise. See **Cleaning the Alloy Wheels** (page 308).



See **Warning Lamps and Indicators** (page 103).

Wet brakes result in reduced braking efficiency. Gently press the brake pedal a few times when driving from a car wash or standing water to dry the brakes.

## Brake Over Accelerator

In the event the accelerator pedal becomes stuck or entrapped, apply steady and firm pressure to the brake pedal to slow the vehicle and reduce engine power. If you experience this condition, apply the brakes and bring your vehicle to a safe stop. Move the transmission selector lever to position **P**, switch the engine off and apply the parking brake. Inspect the accelerator pedal for any interference. If none are found and the condition persists, have your vehicle towed to the nearest authorized dealer.

## Brake Assist

Brake assist detects when you brake heavily by measuring the rate at which you press the brake pedal. It provides maximum braking efficiency as long as you press the pedal. Brake assist can reduce stopping distances in critical situations.

## Anti-lock Brake System

This system helps you maintain steering control during emergency stops by keeping the brakes from locking.



This lamp momentarily illuminates when you turn the ignition on. If the light does not illuminate during start up, remains on or flashes, the anti-lock braking system may be disabled. Have the system checked by an authorized dealer.



If the system is disabled, normal braking is still effective. If the brake warning lamp illuminates when you release the parking brake, have your system checked by an authorized dealer.

## Regenerative Braking System

This feature is used to simulate the engine braking of an internal combustion engine and assist the standard brake system while recovering some of the energy of motion and storing it in the battery to improve fuel economy. The standard brake system is designed to fully stop the car if regenerative braking is not available. During regenerative

# Brakes

braking, the motor is spun as a generator to create electrical current. This recharges the battery and slows the vehicle. In effect, once the accelerator pedal is released, the motor changes from an energy user to an energy producer.

When you release the accelerator pedal or press the brake pedal, the brake controller automatically detects the amount of deceleration requested and optimizes how much of the deceleration will be produced by regenerative braking. The remaining portion is generated by standard friction braking. When the battery is almost fully charged, the amount of regenerative braking is limited to avoid overcharging, and the requested deceleration is produced by standard friction braking alone.

Regenerative braking does not take the place of the standard friction brakes; it only assists them. Regenerative braking has also been designed to interact with the anti-lock brake system. Regenerative braking is disabled when the anti-lock brake system is activated or the battery is fully charged.

## HINTS ON DRIVING WITH ANTI-LOCK BRAKES

**Note:** *When the system is operating, the brake pedal will pulse and may travel further. Maintain pressure on the brake pedal. You may also hear a noise from the system. This is normal.*

The anti-lock braking system will not eliminate the risks when:

- You drive too closely to the vehicle in front of you.
- Your vehicle is hydroplaning.
- You take corners too fast.
- The road surface is poor.

## ELECTRIC PARKING BRAKE

The electric parking brake replaces the conventional handbrake. The operating switch is located on the instrument panel to the left of the steering wheel.

### WARNING



Always set the parking brake and leave your vehicle with the transmission in park (P).

**Note:** *When you apply the electric parking brake in certain conditions, for example on a steep hill, the electric parking brake may reapply the brakes within three to ten minutes. As a result, you may notice various noises when you apply and release the electric parking brake. This is normal and no cause for concern.*

## Applying the electric parking brake

### WARNING



If the brake system warning lamp does not illuminate or flashes, there could be a problem with your electric parking brake. Have the system checked by an authorized dealer as soon as possible.

# Brakes

**Note:** The brake system warning lamp will illuminate for ten seconds if the ignition is turned off after the electric parking brake has been applied, or the electric parking brake has been applied after the ignition has been turned off.

**Note:** The electric parking brake will not automatically apply. You must apply the electric parking brake using the electric parking brake switch.

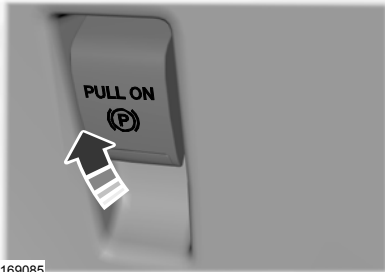

E169085

Pull the switch to apply the electric parking brake.

The brake system warning lamp will illuminate to confirm that the electric parking brake has been applied. See **Information Displays** (page 109).

## Applying the electric parking brake when the vehicle is moving

### WARNINGS

 Applying the electric parking brake while moving will result in use of the anti-lock braking system. Do not use the electric parking brake system when the vehicle is moving unless the normal brake system is unable to stop the vehicle.

 With the exception of emergency conditions (for example, the brake pedal does not work or is blocked), do not apply the electric parking brake while the vehicle is moving. On bends, or poor road surfaces or weather conditions, emergency braking can cause the vehicle to skid out of control or off the road.

If you apply the electric parking brake when your vehicle is moving, the brake system warning lamp will illuminate and a warning chime will sound. See **Information Displays** (page 109).

If your vehicle speed is above 4 mph (6 km/h), the braking force is applied as long as the switch is applied. Release or press the switch, or press the accelerator pedal to stop the braking force.

## Releasing the electric parking brake

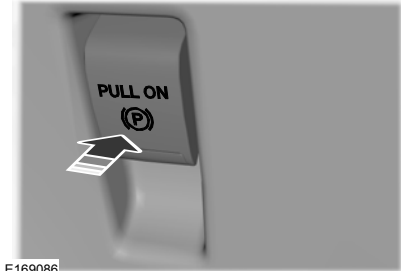

E169086

Release the electric parking brake either manually by pressing the switch down or automatically.

# Brakes

## Manual release

### WARNING



If the brake system warning light remains illuminated or flashes after you have released the parking brake, there could be a problem with your braking system. Have the system checked by an authorized dealer as soon as possible.

You can manually release the electric parking brake by:

1. Turning the ignition on.
2. Pressing the brake pedal.
3. Pressing the electric parking brake switch.

When the electric parking brake is released, the brake system warning lamp will turn off.

### Automatic release - drive away release

Your vehicle will automatically release the parking brake if:

- The driver door is closed.
- The driver safety belt is fastened.

- The vehicle is accelerated.
- There are no faults detected in the parking brake system.

**Note:** *If the electric parking brake warning lamp stays illuminated, the electric parking brake will not automatically release. You must release the electric parking brake using the electric parking brake switch.*

**Note:** *On hybrid vehicles, the vehicle must be Ready-to-Drive as indicated by the green ready indicator light.*

The brake system warning lamp will go off to confirm that the electric parking brake has been released.

**Note:** *The electric parking brake drive away release makes starting on a hill easier. This feature will release the parking brake automatically when the vehicle has sufficient drive force to move up the hill. To assure drive away release when starting uphill, press the accelerator pedal quickly.*

## Battery With No Charge

### WARNING



You will not be able to apply or release the electric parking brake if the battery is low or has no charge.

If the battery is low or has no charge, use jumper cables and a booster battery.

## HILL START ASSIST

### WARNINGS



The system does not replace the parking brake. When you leave your vehicle, always apply the parking brake and put the transmission in park (P).



You must remain in your vehicle once you have activated the system.



During all times, you are responsible for controlling your vehicle, supervising the system and intervening, if required.



If the engine is revved excessively, or if a malfunction is detected, the system will be deactivated.

# Brakes

---

The system makes it easier to pull away when your vehicle is on a slope without the need to use the parking brake.

When the system is active, your vehicle will remain stationary on the slope for two to three seconds after you release the brake pedal. This allows you time to move your foot from the brake to the accelerator pedal. The brakes are released automatically once the engine has developed sufficient drive to prevent your vehicle from rolling down the slope. This is an advantage when pulling away on a slope, (for example from a car park ramp, traffic lights or when reversing uphill into a parking space).

The system will activate automatically on any slope that will cause significant vehicle rollback.

## Using Hill Start Assist

1. Press the brake pedal to bring your vehicle to a complete standstill. Keep the brake pedal pressed.
2. If the sensors detect that your vehicle is on a slope, the system will activate automatically.
3. When you remove your foot from the brake pedal, your vehicle will remain on the slope without rolling away for about two or three seconds. This hold time will automatically be extended if you are in the process of driving off.
4. Drive off in the normal manner. The brakes will release automatically.

# Traction Control

## PRINCIPLE OF OPERATION

The traction control system helps avoid drive wheel spin and loss of traction.

If your vehicle begins to slide, the system applies the brakes to individual wheels and, when needed, reduces engine power at the same time. If the wheels spin when accelerating on slippery or loose surfaces, the system reduces engine power in order to increase traction.

## USING TRACTION CONTROL

In certain situations for example, stuck in snow or mud, turning the traction control off may be beneficial as this allows the wheels to spin with full engine power. Depending on the type of system you have on your vehicle, you can either turn the system off using the information display or by pressing the button.

## Switching the System Off Using the Information Display Controls (If Equipped)

Your vehicle comes with this feature already enabled. If required, you can switch this feature off using the information display controls. See **General Information** (page 109).

## Switching the System Off Using a Switch (If Equipped)

The button is located in the instrument panel.

Press the button. You will see a message in conjunction with an illuminated icon in the display. Press the button again to return the system to normal mode.

When you switch the traction control system off, stability control remains fully active.

## System Indicator Lights and Messages

### WARNING



If a failure has been detected within the AdvanceTrac system, the stability control light will illuminate steadily. Verify that the AdvanceTrac system was not manually disabled through the information display. If the stability control light still illuminates steadily, have the system serviced by an authorized dealer immediately. Operating your vehicle with AdvanceTrac disabled could lead to an increased risk of loss of vehicle control, vehicle rollover, personal injury and death.



The stability control light temporarily illuminates on engine start-up and flashes when a driving condition activates the stability system.



The stability control off light temporarily illuminates on engine start-up and stays on when you turn the traction control system off.

# Traction Control

---

When you turn the traction control system off or on, a message appears in the information display showing system status.

# Stability Control

## PRINCIPLE OF OPERATION

### WARNINGS

 Vehicle modifications involving braking system, aftermarket roof racks, suspension, steering system, tire construction and wheel and tire size may change the handling characteristics of the vehicle and may adversely affect the performance of the AdvanceTrac system. In addition, installing any stereo loudspeakers may interfere with and adversely affect the AdvanceTrac system. Install any aftermarket stereo loudspeaker as far as possible from the front center console, the tunnel, and the front seats in order to minimize the risk of interfering with the AdvanceTrac sensors. Reducing the effectiveness of the AdvanceTrac system could lead to an increased risk of loss of vehicle control, vehicle rollover, personal injury and death.

 Remember that even advanced technology cannot defy the laws of physics. It's always possible to lose control of a vehicle due to inappropriate driver input for the conditions. Aggressive driving on any road condition can cause you to lose control

### WARNINGS

of your vehicle increasing the risk of personal injury or property damage. Activation of the AdvanceTrac system is an indication that at least some of the tires have exceeded their ability to grip the road; this could reduce the operator's ability to control the vehicle potentially resulting in a loss of vehicle control, vehicle rollover, personal injury and death. If your AdvanceTrac system activates, **SLOW DOWN**.

The AdvanceTrac Control system helps you keep control of your vehicle when on a slippery surface. The electronic stability control portion of the system helps avoid skids and lateral slides. The traction control system helps avoid drive wheel spin and loss of traction. See **Using Traction Control** (page 197).

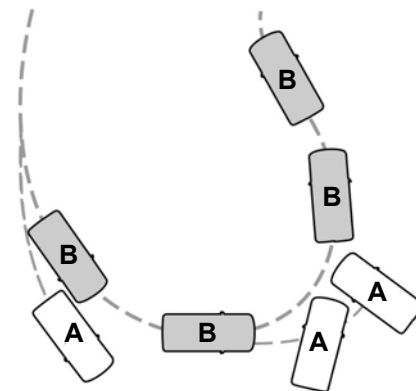

E72903

- A Vehicle without AdvanceTrac skidding off its intended route.
- B Vehicle with AdvanceTrac maintaining control on a slippery surface.

# Stability Control

---

## USING STABILITY CONTROL

### AdvanceTrac®

The system automatically activates when you start your vehicle. The AdvanceTrac system cannot be completely turned off, but the electronic stability control system is disabled when the transmission selector lever is in position **R**. You can turn off the traction control portion of the system independently. See **Using Traction Control** (page 197).

# Parking Aids

## PARKING AID (If Equipped)

### WARNINGS



To help avoid personal injury, please read and understand the limitations of the system as contained in this section.

Sensing is only an aid for some (generally large and fixed) objects when moving in reverse on a flat surface at parking speeds. Traffic control systems, inclement weather, air brakes, and external motors and fans may also affect the function of the sensing system; this may include reduced performance or a false activation.



To help avoid personal injury, always use caution when in reverse (R) and when using the sensing system.



This system is not designed to prevent contact with small or moving objects. The system is designed to provide a warning to assist the driver in detecting large stationary objects to avoid damaging the vehicle. The system may not detect smaller objects, particularly those close to the ground.

### WARNINGS



Certain add-on devices such as large trailer hitches, bike or surfboard racks and any device that may block the normal detection zone of the system, may create false beeps.

**Note:** *Keep the sensors, located on the bumper or fascia, free from snow, ice and large accumulations of dirt. If the sensors are covered, the system's accuracy can be affected. Do not clean the sensors with sharp objects.*

**Note:** *If your vehicle sustains damage to the bumper or fascia, leaving it misaligned or bent, the sensing zone may be altered causing inaccurate measurement of obstacles or false alarms.*

**Note:** *If your vehicle is equipped with MyKey®, it is possible to prevent turning the sensing system off. See **MyKey™** (page 59).*

The sensing system warns the driver of obstacles within a certain range of the bumper area. The system turns on automatically whenever the ignition is switched on.

When receiving a detection warning, the radio volume is reduced to a predetermined level. After the warning goes away, the radio volume returns to the previous level.

The system can be switched off through the information display menu or from the pop-up message that appears once the transmission is shifted into reverse (R) or a front obstacle is detected. See **General Information** (page 109).

If a fault is present in the system, a warning message appears in the information display and does not allow the driver to switch the faulted system on. See **Information Messages** (page 120).

# Parking Aids

## Rear Sensing System

The rear sensors are only active when the transmission is in reverse (R). As the vehicle moves closer to the obstacle, the rate of the audible warning increases. When the obstacle is fewer than 9.84 in (25 cm) away, the warning sounds continuously. If a stationary or receding object is detected farther than 9.84 in (25 cm) from the side of the vehicle, the tone sounds for only three seconds. Once the system detects an object approaching, the warning sounds again.



E130178

- A Coverage area of up to 6 feet (2 meters) from the rear bumper. There is decreased coverage area at the outer corners of the bumper.

The system detects certain objects while the transmission is in reverse (R):

- and moving toward a stationary object at a speed of 3 mph (5 km/h) or less.
- but not moving, and a moving object is approaching the rear of the vehicle at a speed of 3 mph (5 km/h) or less.
- and moving at a speed of less than 3 mph (5 km/h) and a moving object is approaching the rear of the vehicle at a speed of less than 3 mph (5 km/h).

## Front Sensing System

The front sensors are active when the gearshift is in any position other than park (P) or neutral (N) and the vehicle speed is below 7 mph (12 km/h).

# Parking Aids

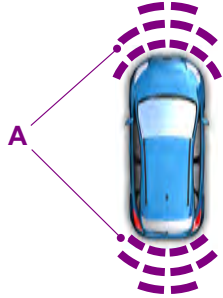

E130382

- A Coverage area of up to 27 inches (70 centimeters) from the front of the vehicle and about 6–14 inches (15–35 centimeters) to the side of the front end of the vehicle. Refer to the reverse sensing section for details on coverage area.

The system sounds an audible warning when obstacles are near either bumper in the following manner:

- Objects detected by the front sensors are indicated by a high-pitched tone from the front radio speakers.
- Objects detected by the rear sensors are indicated by a lower pitched tone from the rear radio speakers.
- The sensing system reports the obstacle which is closest to the front or rear of the vehicle. For example, if an obstacle is 24 inches (60 centimeters) from the front of the vehicle and, at the same time, an obstacle is only 16 inches (40 centimeters) from the rear of the vehicle, the lower pitched tone sounds.
- If there are objects located at the same distance in the front and rear of the vehicle, the system sounds the rear warning.

For specific information on the reverse sensing portion of the system, refer to that section.

## ACTIVE PARK ASSIST (If Equipped)

### WARNING

 This system is designed to be a supplementary park aid. It may not work in all conditions and is not intended to replace the driver's attention and judgment. The driver is responsible for avoiding hazards and maintaining a safe distance and speed, even when the system is in use.

**Note:** *The driver is always responsible for controlling the vehicle, supervising the system and intervening if required.*

**Note:** *The sensors may not detect objects in heavy rain or other conditions that cause disruptive reflections.*

**Note:** *The sensors may not detect objects with surfaces that absorb ultrasonic waves.*

The system detects an available parallel parking space and automatically steers the vehicle into the space (hands-free) while you control the accelerator, gearshift and brakes. The system visually and audibly instructs you to park the vehicle.

# Parking Aids

The system may not function correctly if something passes between the front bumper and the parking space (for example, a pedestrian or cyclist) or if the edge of the neighboring parked vehicle is high from the ground (such as a bus, tow truck or flatbed truck).

You should not use the system if:

- A foreign object (such as a bike rack or trailer) is attached to the front or rear of the vehicle or at another location close to the sensors.
- An overhanging object (such as a surfboard) is attached to the roof.
- The front bumper or side sensors are damaged (in a collision) or obstructed by a foreign object (such as a front bumper cover).
- A mini-spare tire is in use.

## Using Active Park Assist



Press the button located on the right-hand side of the center stack.

The touch screen displays a message and a corresponding graphic to indicate it is searching for a parking space. Use the direction indicator to indicate which side of the vehicle you want the system to search on.

**Note:** *If the direction indicator is not on, the system automatically searches on the passenger side of the vehicle.*



# Parking Aids

When the system finds a suitable space, the touch screen displays a message and a tone sounds. Slow down and stop when the touch screen displays a message and a chime sounds (at approximately position A), then follow the instructions on the touch screen.

**Note:** You must observe that the selected space remains clear of obstructions at all times in the maneuver.

**Note:** Vehicles with overhanging loads (such as a bus or a truck), active park assist may not detect street furniture and other items. You must make sure the system selects a space suitable for parking.

**Note:** Drive the vehicle as parallel to other vehicles as possible while passing a parking space.

**Note:** The system always offers the last detected parking space (for example, if the vehicle detects multiple spaces while you are driving, it offers the last one).

**Note:** If driven above approximately 22 mph (35 km/h), the touch screen shows a message to alert you to reduce vehicle speed.

## Automatic Steering into Parking Space

**Note:** If vehicle speed exceeds 6 mph (10 km/h), the system turns off and you need to take full control of the vehicle.

When you shift the transmission into reverse (R), with your hands off the wheel (and nothing obstructing its movement), the vehicle steers itself into the space. Instructions to safely move your vehicle back and forth in the space display in the touch screen and a tone sounds.



# Parking Aids

When you think your vehicle has enough space in front and behind it, or you hear a solid tone from the parking aid (accompanied by a touch screen display message and a tone), bring your vehicle to a complete stop.

When automatic steering is complete, the touch screen displays a message and a tone sounds, indicating that the active park assist process is done. The driver is responsible for checking the parking job and make any necessary corrections before putting the transmission in park (P).

## Deactivating the Park Assist Feature

The system can be deactivated manually by:

- Pressing the active park assist button.
- Grabbing the steering wheel.
- Driving above approximately 50 mph (80 km/h) for 10 seconds during an active park search.
- Driving above 6 mph (10 km/h) during automatic steering.
- Switching off the traction control system.

Certain vehicle conditions can also deactivate the system, such as:

- Traction control can activate on a slippery or loose surface.
- An anti-lock brake system activation or failure.
- If something touches the steering wheel.

If a problem occurs with the system, a warning message displays and a tone sounds. Occasional system messages may occur in normal operation. For recurring or frequent system faults, contact an authorized dealer to have your vehicle serviced.

## Troubleshooting the System

The system does not look for a space
The traction control system may be off.
The transmission is in reverse (R), the vehicle must be moving forward to detect a parking space.

# Parking Aids

---

<b>The system does not offer a particular space</b>
Something may be contacting the front bumper or side sensors.
There is not enough room on both sides of the vehicle in order to park.
There is not enough space for the parking maneuver on the opposite side of the parking space.
The vehicle is going faster than 22 mph (35 km/h).
The vehicle is farther than 4.9 ft (1.5 m) from the parking space.
The vehicle is closer than 15.75 in (40 cm) from neighboring parked vehicles.
The transmission is in reverse (R), the vehicle must be moving forward to detect a parking space.

<b>The system does not position the vehicle where I want in the space</b>
The vehicle is rolling in the opposite direction of the transmission (for example, rolling forward when you select reverse [R]).
An irregular curb along the parking space prevents the system from aligning the vehicle properly.
Vehicles or objects bordering the space may not be in the correct position.
You drove the vehicle too far past the parking space. The system performs best when you drive the same distance past the parking space.
The tires may not be installed or maintained correctly (for example, not inflated correctly, improper size, or of different sizes).
A repair or alteration has changed detection capabilities.

# Parking Aids

## The system does not position the vehicle where I want in the space

A parked vehicle has a high attachment (for example, a salt sprayer, snowplow, or a moving truck bed).

The parking space length or position of parked objects changed after your vehicle passed.

The temperature around your vehicle changes quickly (for instance, driving from a heated garage into the cold, or after leaving a car wash).

## REAR VIEW CAMERA (If Equipped)

### WARNINGS

 The rear view camera system is a reverse aid supplement device that still requires the driver to use it in conjunction with the interior and exterior mirrors for maximum coverage.

 Objects that are close to either corner of the bumper or under the bumper, might not be seen on the screen due to the limited coverage of the camera system.

 Back up as slow as possible since higher speeds might limit your reaction time to stop your vehicle.

### WARNINGS

 Use caution when using the rear video camera and the trunk is ajar. If the trunk is ajar, the camera will be out of position and the video image may be incorrect. All guidelines (if enabled) have been removed when the trunk is ajar.

 Use caution when turning camera features on or off while in reverse (R). Make sure your vehicle is not moving.

The rear view camera system provides a video image of the area behind your vehicle. The image will display in either the rear view mirror or the display in the center of the instrument panel.

During operation, lines will appear in the display that represent your vehicle's path and proximity to objects behind your vehicle.



E152548

The camera is located on the trunk near the high-mount brake lamp.

# Parking Aids

---

## Using the Rear View Camera System

The rear view camera system displays what is behind your vehicle when you place the transmission in reverse (R).

The system uses three types of guides to help you see what is behind your vehicle:

- Active guidelines: Show the intended path of your vehicle when reversing.
- Fixed guidelines: Show the actual path your vehicle is moving in while reversing in a straight line. This can be helpful when backing into a parking space or aligning your vehicle with another object behind you.
- Centerline (if applicable): Helps align the center of your vehicle with an object (trailer).

**Note:** *If the transmission is in reverse (R) and the luggage compartment is ajar, no rear view camera features will display.*

**Note:** *If the image comes on while the transmission is not in reverse (R), have the system inspected by an authorized dealer.*

**Note:** *When towing, the camera only sees what you are towing behind your vehicle. This might not provide adequate coverage and you might not see some objects. In some vehicles, the guidelines may disappear once you connect the trailer tow connector.*

The camera may not operate correctly under the following conditions:

- Nighttime or dark areas if the reverse lamps are not operating.
- Mud, water or debris obstructs the camera's view. Clean the lens with a soft, lint-free cloth and non-abrasive cleaner.
- The camera is misaligned due to damage to the rear of your vehicle.

To access any of the rear view camera system settings, make the following selections in the touch screen when the transmission is not in reverse (R):

- Menu > Vehicle > Camera Settings

After changing a system setting, the touch screen shows a preview of the selected features.

## Guidelines and the Centerline

**Note:** *Active guidelines and fixed guidelines are only available when the transmission is in reverse (R).*

**Note:** *The centerline is only available if Active or Fixed guidelines are on.*

# Parking Aids

- D Fixed guideline: Yellow zone
- E Fixed guideline: Red zone
- F Rear bumper

Active guidelines are only shown with fixed guidelines. To use active guidelines, turn the steering wheel to point the guidelines toward an intended path. If you change the steering wheel position while reversing, your vehicle might deviate from the original intended path.

The fixed and active guidelines fade in and out depending on your steering wheel position. When your steering wheel position is straight, the active guidelines are not visible.

Always use caution while reversing. Objects in the red zone are closest to your vehicle and objects in the green zone are farther away. Objects are getting closer to your vehicle as they move from the green zone to the yellow or red zones. Use the side view mirrors and rear view mirror to get better coverage on both sides and rear of your vehicle.

## Enhanced Park Aids

**Note:** Enhanced park aids are only available when the transmission is in reverse (R).

**Note:** The reverse sensing system is not effective at speeds above 3 mph (5 km/h) and may not detect certain angular or moving objects.

The system uses red, yellow and green highlights that appear on top of the video image when the reverse sensing system detects an object. The alert highlights the closest object detected. You can disable the reverse sensing alert if you have enhanced park aids enabled, you will still see the displayed highlighted areas.

Selectable settings for this feature are ON and OFF.

## Manual Zoom

### WARNING



When manual zoom is on, the full area behind your vehicle is not shown. Be aware of your surroundings when using the manual zoom feature.

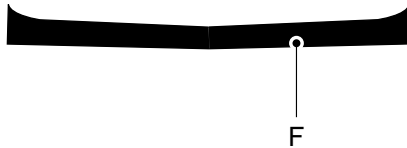
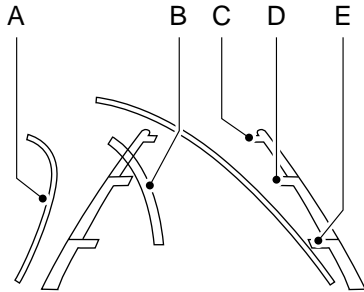

E142436

- A Active guidelines
- B Centerline
- C Fixed guideline: Green zone

# Parking Aids

---

**Note:** *Manual zoom is only available when the transmission is in reverse (R).*

**Note:** *Only the centerline shows when you enable manual zoom.*

This allows you to get a closer view of an object behind your vehicle. The zoomed image keeps the bumper in the image to provide a reference. The zoom is only active while the transmission is in reverse (R). When you shift the transmission out of reverse (R), the feature automatically turns off and you must enable it to use it again.

Selectable settings for this feature are ON and OFF.

## **Rear Camera Delay**

When shifting the transmission out of reverse (R) and into any gear other than park (P), the camera image remains in the display until your vehicle speed reaches 5 mph (8 km/h) or until you select a radio button.

Selectable settings for this feature are ON and OFF. The default setting for the rear camera delay is OFF.

# Cruise Control

## PRINCIPLE OF OPERATION

Cruise control lets you maintain a set speed without keeping your foot on the accelerator pedal. You can use cruise control when your vehicle speed is greater than 20 mph (30 km/h).

## USING CRUISE CONTROL

### WARNINGS

 Do not use cruise control in heavy traffic, on winding roads or when the road surface is slippery. This could result in loss of vehicle control, serious injury or death.

 When you are going downhill, your vehicle speed may increase above the set speed. The system will not apply the brakes. Change down a gear to assist the system in maintaining the set speed. Failure to do so could result in loss of vehicle control, serious injury or death.

### WARNINGS

 When you are going downhill while using cruise control, your battery charging system and engine work together to help maintain your set speed. Engine noise may increase or decrease under these conditions.

**Note:** *Cruise control will disengage if the vehicle speed decreases more than 10 mph (16 km/h) below your set speed while driving uphill.*

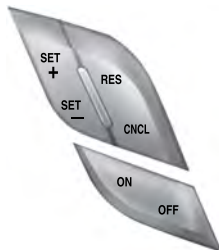

E145976

The cruise controls are located on the steering wheel.

## Switching Cruise Control On

Press and release **ON**.



The indicator will appear in the instrument cluster.

## Setting a Speed

1. Accelerate to the desired speed.
2. Press and release **SET+**.
3. Take your foot off the accelerator pedal.

The indicator will change colors in the instrument cluster.

## Changing the Set Speed

**Note:** *If you accelerate by pressing the accelerator pedal, the set speed will not change. When you release the accelerator pedal, you will return to the speed that you previously set.*

# Cruise Control

- Press and hold **SET+** or **SET-**. Release the control when you reach the desired speed.
- Press and release **SET+** or **SET-**. The set speed will change in approximately 1 mph (2 km/h) increments.
- Press the accelerator or brake pedal until you reach the desired speed. Press and release **SET+**.

## Canceling the Set Speed

Press **CNCL** or tap the brake pedal. You will not erase the set speed.

## Resuming the Set Speed

Press and release **RES**.

## Switching Cruise Control Off

**Note:** *You will erase the set speed if you switch the system off.*

Press and release **OFF** or switch the ignition off.

## ECO Cruise Control

This feature saves vehicle energy by relaxing acceleration compared to standard cruise control. For example, your vehicle may temporarily lose speed when going uphill. **ECO** will appear in the information display when ECO cruise control is activated. It can be switched on or off in the information display. See **General Information** (page 109).

## USING ADAPTIVE CRUISE CONTROL (If Equipped)

### WARNINGS



Always pay close attention to changing road conditions, especially when using adaptive cruise control. Adaptive cruise control cannot replace attentive driving. Failing to follow any of the warnings below or failing to pay attention to the road may result in a crash, serious injury or death.



Adaptive cruise control is not a crash warning or avoidance system.

### WARNINGS



Adaptive cruise control will not detect stationary or slow moving vehicles below 6 mph (10 km/h).



Adaptive cruise control will not detect pedestrians or objects in the roadway.



Adaptive cruise control will not detect oncoming vehicles in the same lane.



Do not use the adaptive cruise control when entering or leaving a highway, in heavy traffic or on roads that are winding, slippery or unpaved.



Do not use in poor visibility, specifically fog, rain, spray or snow.

**Note:** *It is your responsibility to stay alert, drive safely and be in control of the vehicle at all times.*

The system adjusts your speed to maintain a proper distance between you and the vehicle in front of you in the same lane. You can select from one of four gap settings.

# Cruise Control

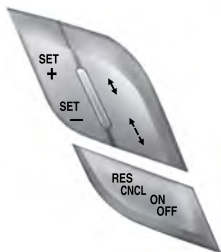

E145977

The controls for using your cruise control are located on the steering wheel.

## Switching the System On

Press and release **ON**.



The information display will show the grey indicator light.

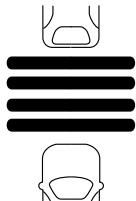

E164805

The current gap setting and **SET** will also display.

## Setting a Speed

1. Accelerate to the desired speed.
2. Press and release **SET+**. The vehicle speed will be stored in the memory.
3. The information display will show a green indicator light, current gap setting and desired set speed.
4. Take your foot off the accelerator pedal.

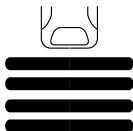

E164805

5. A lead vehicle graphic will illuminate if there is a vehicle detected in front of you.

**Note:** When adaptive cruise control is active, the speedometer may vary slightly from the set speed displayed in the information display.

## Following a Vehicle

### WARNINGS



When following a vehicle in front of you, your vehicle will not decelerate automatically to a stop, nor will your vehicle always decelerate quickly enough to avoid a crash without driver intervention. Always apply the brakes when necessary. Failing to do so may result in a crash, serious injury or death.



Adaptive cruise control only warns of vehicles detected by the radar sensor. In some cases there may be no warning or a delayed warning. You should always apply the brakes when necessary. Failing to do so may result in a crash, serious injury or death.

**Note:** The brakes may emit a sound when modulated by the adaptive cruise control system.

When a vehicle ahead of you enters the same lane or a slower vehicle is ahead in the same lane, the vehicle speed adjusts to maintain a preset gap distance. The distance setting is adjustable.

# Cruise Control

The lead vehicle graphic will illuminate.

To help you pass while adaptive cruise control is active, when you switch on your left turn signal, you may experience a small temporary acceleration.

The vehicle will maintain a constant distance between the vehicle ahead until:

- the vehicle in front of you accelerates to a speed above the set speed
- the vehicle in front of you moves out of your lane or out of view
- the vehicle speed falls below 12 mph (20 km/h)
- a new gap distance is set.

The vehicle will apply the brakes to slow the vehicle to maintain a safe distance from the vehicle in front. The maximum braking which the system can apply is limited. You can override the system by applying the brakes.

If the system predicts that its maximum braking level will not be sufficient, an audible warning will sound while the system continues to brake. This is accompanied by a heads-up display; a red warning bar illuminating on the windshield. You should take immediate action.

## Setting the Gap Distance

**Note:** *It is your responsibility to select a gap appropriate to the driving conditions.*

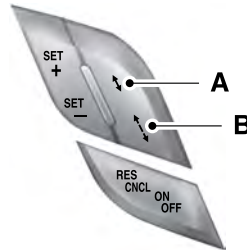

E145978

- A Gap decrease
- B Gap increase

You can decrease or increase the distance between your vehicle and the vehicle in front of you by pressing the gap control.

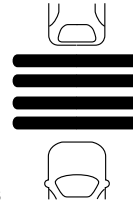

E164805

The selected gap appears in the information display as shown by the bars in the graphic. Four gap distance settings are available.

# Cruise Control

## Adaptive cruise control, distance between vehicle settings

Set speed mph ( km/h)	Graphic display, bars indicated between vehicles	Time gap, seconds	Distance gap yd (m)	Dynamic behavior
62 (100)	1	1	31 (28)	Sport
62 (100)	2	1.4	43 (39)	Normal
62 (100)	3	1.8	55 (50)	Normal
62 (100)	4	2.2	67 (61)	Comfort

Each time you start the vehicle, the system will select the last chosen gap for the current driver.

### Disengaging the System

Press the brake pedal or press **CNCL**. The last set speed will display in grey but will not erase.

### Overriding the System

#### WARNING



Whenever the driver is overriding the system by pressing the accelerator pedal, the system will not automatically apply the brakes to maintain separation from any vehicle ahead.

You can override the set speed and gap distance by pressing the accelerator pedal.



When you override the system, the green indicator light illuminates and the lead vehicle graphic does not show in the information display.

The system will resume operation when you release the accelerator pedal. The vehicle speed will decrease to the set speed, or a lower speed if following a slower vehicle.

# Cruise Control

---

## Changing the Set Speed

- Accelerate or brake to the desired speed, then press and release **SET+**.
- Press and hold **SET+** or **SET-** until the desired set speed shows on the information display. The vehicle speed will gradually change to the selected speed.
- Press and release **SET+** or **SET-**. The set speed will change in approximately 1 mph (2 km/h) increments.

The system may apply the brakes to slow the vehicle to the new set speed. The set speed will display continuously in the information display while the system is active.

## Resuming the Set Speed

**Note:** *Only use resume if you are aware of the set speed and intend to return to it.*

Press and release **RES**. The vehicle will return to the previously set speed. The set speed will display continuously in the information display while the system is active.

## Low Speed Automatic Cancellation

The system is not functional at vehicle speeds below 12 mph (20 km/h). An audible alarm will sound and the automatic braking releases if the vehicle drops below this speed.

## Hilly Condition Usage

**Note:** *An audible alarm will sound and the system will shut down if it is applying brakes for an extended period of time. This allows the brakes to cool down. The system will function normally again when the brakes have cooled down.*

You should select a lower gear position when the system is active in situations such as prolonged downhill driving on steep grades, for example in mountainous areas. The system needs additional engine braking in these situations to reduce the load on the vehicle's regular brake system to prevent them from overheating.

## Switching the System Off

**Note:** *The set speed memory erases when you switch off the system.*

Press and release **OFF** or turn off the ignition.

## Detection Issues

The radar sensor has a limited field of vision. It may not detect vehicles at all or detect a vehicle later than expected in some situations. The lead vehicle graphic will not illuminate if the system does not detect a vehicle in front of you.

# Cruise Control

**A**

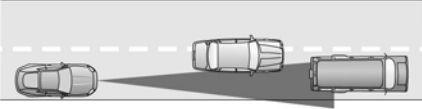

**B**

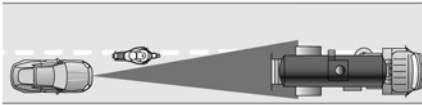

**C**

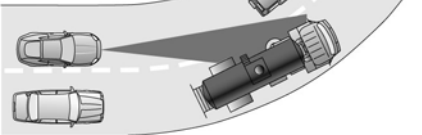

E71621

Detection issues can occur:

- A When driving on a different line than the vehicle in front.
- B With vehicles that edge into your lane. The system can only detect these vehicles once they move fully into your lane.
- C There may be issues with the detection of vehicles in front when driving into and coming out of a bend or curve in the road.

In these cases, the system may brake late or unexpectedly. The driver should stay alert and intervene when necessary.

If something hits the front end of your vehicle or damage occurs, the radar-sensing zone may change. This could cause missed or false vehicle detections. See an authorized dealer to have the radar checked for proper coverage and operation.

## System Not Available

Conditions that can cause the system to deactivate or prevent the system from activating when requested include:

- a blocked sensor
- high brake temperature
- a failure in the system or a related system.

## Blocked Sensor

### WARNINGS



Do not use the system when towing a trailer with electronic brake controls. Aftermarket trailer brakes will not function properly when you switch the system on because the brakes are electronically controlled. Failing to do so may result in loss of vehicle control, which could result in serious injury. The system does operate with non-electronic trailer brake controllers, such as over-run or surge brakes.

# Cruise Control

## WARNINGS



Do not use tire sizes other than those recommended because this can affect the normal operation of the system. Failing to do so may result in a loss of vehicle control, which could result in serious injury.



E145632

A message displays if something obstructs the radar signals from the sensor. The sensor is located behind a fascia cover near the driver side of the lower grille. The system cannot detect a vehicle ahead and will not function when something obstructs the radar signals. The following table lists possible causes and actions for this message displaying.

Cause	Action
The surface of the radar in the grille is dirty or obstructed in some way.	Clean the grille surface in front of the radar or remove the object causing the obstruction.
The surface of the radar in the grille is clean but the message remains in the display.	Wait a short time. It may take several minutes for the radar to detect that it is free from obstruction.
Heavy rain or snow is interfering with the radar signals.	Do not use the system in these conditions because it may not detect any vehicles ahead.
Swirling water, or snow or ice on the surface of the road may interfere with the radar signals.	Do not use the system in these conditions because it may not detect any vehicles ahead.
You are in a desert or remote area with no other vehicles and no roadside objects.	Wait a short time or switch to normal cruise control.

# Cruise Control

---

Due to the nature of radar technology, it is possible to get a blockage warning and not be blocked. This can happen, for example, when driving in sparse rural or desert environments. A false blocked condition will either self clear or clear after a key cycle.

## Switching to Normal Cruise Control

### WARNING



Normal cruise control will not brake due to slower vehicles. Always be aware of which mode you have selected and apply the brakes when necessary.

---

You can manually change from adaptive cruise control to normal cruise control through the information display.



The cruise control indicator light replaces the adaptive cruise control indicator light if you select normal cruise control. The gap setting will not display, the system will not automatically respond to lead vehicles and automatic braking will not activate.

## ECO Cruise Control

This feature saves vehicle energy by relaxing acceleration compared to standard cruise control. For example, your vehicle may temporarily lose speed when going uphill. **ECO** will appear in the information display when you activate ECO cruise control. It can be switched on or off in the information display. See (page 109).

# Driving Aids

## DRIVER ALERT (If Equipped)

### WARNING



The driver alert system is designed to aid you. It is not intended to replace your attention and judgment. You are still responsible to drive with due care and attention.

**Note:** The system will store the on or off setting in the information display menu through ignition cycles.

**Note:** If enabled in the menu, the system will be active at speeds above 40 mph (64 km/h). When below the activation speed, the information display will inform you that the system is unavailable.

**Note:** The system works as long as one lane marking can be detected by the camera.

**Note:** If the camera is blocked or if the windshield is damaged, the system may not function.

**Note:** The system may not be available in poor weather or other low visibility conditions.

The system automatically monitors your driving behavior using various inputs including the front camera sensor.

If the system detects that your driving alertness is reduced below a certain threshold, the system will alert you using a chime and a message in the information display.

### Using Driver Alert

#### Switching the system on and off

You may switch the system on or off through the information display by selecting Settings then Driver Assist then Driver Alert in the menu. When activated, the system will monitor your alertness level based upon your driving behavior in relation to the lane markings, and other factors.

#### System Warnings

**Note:** Note: The system will not issue warnings below approximately 40 mph (64 km/h).

The warning system is in two stages. At first the system issues a temporary warning that you need to take a rest. This message will only appear for a short time. If the system detects further reduction in driving alertness, another warning may be issued which will remain in the information display for a longer time. Press OK on the steering wheel control to clear the warning.

### System Display

When active the system will run automatically in the background and only issue a warning if required. You can view the status at any time using the information display. See (page 109).

The alertness level is shown by six steps in a colored bar.

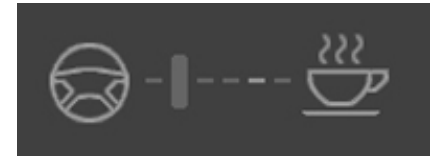

E131358

# Driving Aids

The current assessment of your alertness is within a typical range.



E131359

The current assessment of your alertness indicates that you should rest as soon as safely possible.

The status bar will travel from left to right as the calculated alertness level decreases. As the rest icon is approached the color turns from green to yellow to red. The yellow position indicates the first warning is active and the red position indicates the second warning is active.

**Note:** *If you have recently received a warning; you should consider resting, even if the current assessment is with the typical range.*

**Note:** *If the camera sensor cannot track the road lane markings or if your vehicle speed drops below approximately 40 mph (64 km/h), the alertness level will change to grey for a short time and the information display will inform you that the system is unavailable.*

## Resetting the System

You can reset the system by either:

- Switching the ignition off and on.
- Stopping the vehicle and then opening and closing the driver's door.

## LANE KEEPING SYSTEM (if Equipped)

### WARNING



The system is designed to aid the driver. It is not intended to replace your attention and judgment. You are still responsible to drive with due care and attention.

**Note:** *The system works above 40 mph (64 km/h).*

**Note:** *The system works as long as the camera can detect one lane marking.*

**Note:** *The system may not function if the camera is blocked or there is damage to the windshield.*

**Note:** *When Aid mode is on and the system detects no steering activity for a short period, the system will alert you to put your hands on the steering wheel. The system may detect a light grip or touch on the steering wheel as hands off driving.*

The system notifies you to stay in your lane through the steering system and the instrument cluster display when the front camera detects an unintentional drift out of your lane is likely to occur. The system automatically detects and tracks the road lane markings using a camera mounted behind the interior rear view mirror.

## Switching the System On and Off

**Note:** *The system on or off setting is stored until it is manually changed, unless a MyKey® is detected. If the system detects a MyKey® it defaults to on and the mode is set to Alert.*

# Driving Aids

**Note:** If a MyKey® is detected, pressing the button will not affect the on or off status of the system. You can only change the Mode and Intensity settings.



Press the button located on the left steering wheel stalk to switch the system on or off.

## System Settings

The system has two optional setting menus available. To view or adjust the settings, See **General Information** (page 109). The system stores the last-known selection for each of these settings. You do not need to readjust your settings each time you turn on the system.

**Mode:** This setting allows you to select which of the system features you can enable.

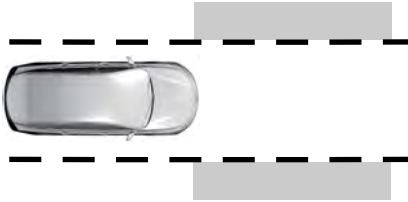

E165515

**Alert only** – Provides a steering wheel vibration when the system detects an unintended lane departure.

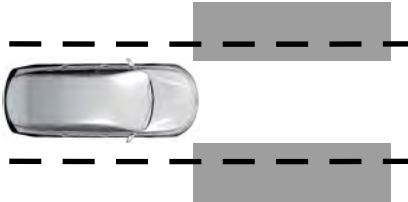

E165516

**Aid only** – Provides an assistance steering torque input toward the lane center when the system detects an unintended lane departure.

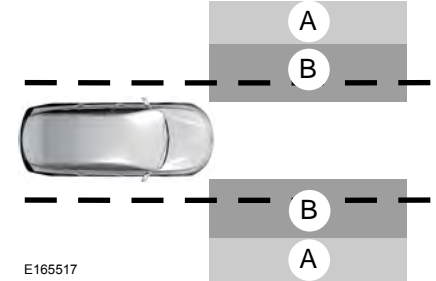

E165517

- A Alert
- B Aid

**Alert + Aid** – Provides an assistance steering torque input toward the lane center. If your vehicle continues drifting out of the lane, the system provides a steering wheel vibration.

**Note:** The alert and aid diagrams illustrate general zone coverage. They do not provide exact zone parameters.

# Driving Aids

**Intensity:** This setting affects the intensity of the steering wheel vibration used for the alert and alert + aid modes. This setting does not affect the aid mode.

- Low
- Medium
- High

## System Display



E151660

When you switch on the system, an overhead graphic of a vehicle with lane markings will display in the information display. If you select aid mode when you switch on the system, a separate white icon will also appear or in some vehicles arrows will display with the lane markings.

When you switch off the system, the lane marking graphics will not display.

While the system is on, the color of the lane markings will change to indicate the system status.

Gray: Indicates that the system is temporarily unable to provide a warning or intervention on the indicated side(s). This may be because:

- Your vehicle is under the activation speed.
- The turn indicator is active.
- Your vehicle is in a dynamic maneuver.

- The road has no or poor lane markings in the camera field-of-view.
- The camera is obscured or unable to detect the lane markings due to environmental conditions (significant sun angles, shadows, snow, heavy rain or fog), traffic conditions (following a large vehicle that is blocking or shadowing the lane), or vehicle conditions (poor headlamp illumination).

See **Troubleshooting** for additional information.

Green: Indicates that the system is available or ready to provide a warning or intervention, on the indicated side(s).

Yellow: Indicates that the system is providing or has just provided a lane keeping aid intervention.

Red: Indicates that the system is providing or has just provided a lane keeping alert warning.

The system can be temporarily suppressed at any time by the following:

- Quick braking.
- Fast acceleration.

# Driving Aids

---

- Using the turn signal indicator.
- Evasive steering maneuver.

## Troubleshooting

Why is the feature not available (line markings are gray) when I can see the lane markings on the road?
Vehicle speed is outside the operational range of the feature
Sun is shining directly into the camera lens
Quick intentional lane change
Staying too close to the lane marking
Driving at high speeds in curves
Previous feature activation happened within the last one second
Ambiguous lane markings (mainly in construction zones)
Rapid transition from light to dark or vice versa
Sudden offset in lane markings
ABS or AdvanceTrac activation
Camera blockage due to dirt, grime, fog, frost or water on the windshield
Driving too close to the vehicle in front of you
Transitioning between no lane markings to lane markings or vice versa
Standing water on the road

# Driving Aids

---

<b>Why is the feature not available (line markings are gray) when I can see the lane markings on the road?</b>
Faint lane markings (partial yellow lane markings on concrete roads)
Lane width too narrow or too wide
Camera not calibrated after a windshield replacement
Driving on tight roads or on uneven roads

<b>Why does the vehicle not come back into the middle of the lane always, as expected, in the Aid or Aid + Alert mode?</b>
High cross winds
Large road crown
Rough roads, grooves, shoulder drop-offs
Heavy uneven loading of the vehicle or improper tire inflation pressure
If the tires have been exchanged (including snow tires), or the suspension has been modified

# Driving Aids

## BLIND SPOT INFORMATION SYSTEM

### Blind Spot Information System (BLIS®) with Cross Traffic Alert (If Equipped)

#### WARNING



To help avoid injuries, NEVER use the BLIS as a replacement for using the interior and exterior mirrors and looking over your shoulder before changing lanes. BLIS is not a replacement for careful driving.

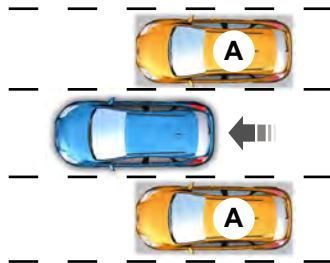

E124788

BLIS aids you in detecting vehicles that may have entered the blind spot zone (A). The detection area is on both sides of the vehicle, extending rearward from the exterior mirrors to approximately 9.8 ft (3 m) beyond the bumper. The system alerts you if certain vehicles enter the blind spot zone while driving.

Cross traffic alert warns you of vehicles approaching from the sides when the transmission is in reverse (R).

**Note:** BLIS is not designed to prevent contact with other vehicles or objects; or to detect parked vehicles, people, animals or infrastructure (for example, fences, guardrails or trees). It is designed to alert the driver to vehicles in the blind zones.

**Note:** When a vehicle passes quickly through the blind zone, typically fewer than two seconds, the system does not trigger.

## Using the Systems

BLIS turns on when the vehicle is started and is driven forward above 5 mph (8 km/h); it remains on while the transmission is in drive (D) or neutral (N). If shifted out of drive (D) or neutral (N), the system enters cross traffic alert mode. Once shifted back into drive (D), BLIS turns back on when the vehicle is driven above 5 mph (8 km/h).

**Note:** BLIS does not function in reverse (R) or park (P) or provide any additional warning when a turn signal is on.

**Note:** Cross traffic alert detects approaching vehicles from up to 45.9 ft (14 m) away though coverage decreases when the sensors are blocked. Reversing slowly helps increase the coverage area and effectiveness.

# Driving Aids

---

## WARNING

 To help avoid personal injury, **NEVER** use the cross traffic alert system as a replacement for using the interior and exterior mirrors and looking over your shoulder before backing out of a parking space. Cross traffic alert is not a replacement for careful driving.

---

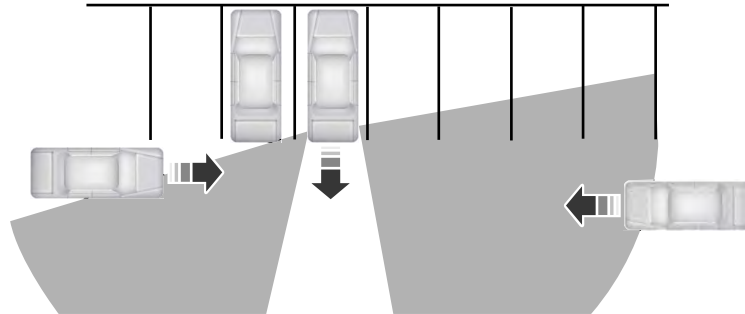

E142440

# Driving Aids

---

In this first example, the left sensor is only partially obstructed; zone coverage is nearly maximized.

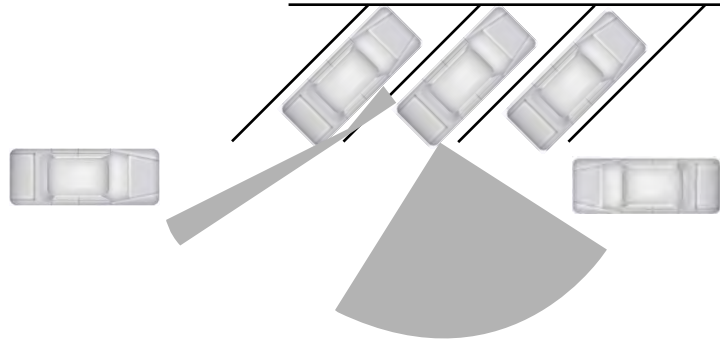

E142441

Zone coverage also decreases when parking at shallow angles. Here, the left sensor is mostly obstructed; zone coverage on that side is severely limited.

# Driving Aids

## System Lights and Messages



E142442

The BLIS and cross traffic alert systems illuminate a yellow alert indicator in the outside mirror on the side of the vehicle the approaching vehicle is coming from.

**Note:** *The alert indicator dims when nighttime darkness is detected.*

Cross traffic alert also sounds an audible warning and a message appears in the information display indicating a vehicle is coming from the right or left. Cross traffic alert works with the reverse sensing system which sounds its own series of tones. See **Parking Aid** (page 201).

## System Sensors

### WARNING



Just prior to the system recognizing a blocked condition and alerting the driver, the number of missed objects will increase. To help avoid injuries, NEVER use the BLIS as a replacement for using the side and rear view mirrors and looking over your shoulder before changing lanes. BLIS is not a replacement for careful driving.

**Note:** *It is possible to get a blockage warning with no blockage present; this is rare and known as a false blockage warning. A false blocked condition either self-corrects or clears after a key cycle.*

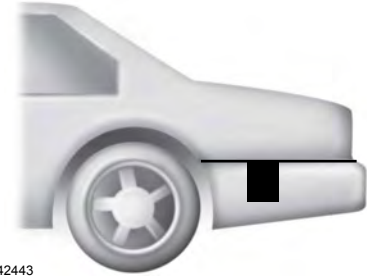

E142443

The system uses radar sensors which are located behind the bumper fascia on each side of your vehicle. Do not allow these areas to become obstructed by mud, snow or bumper stickers, as this can cause degraded system performance.

If the system detects a degraded performance condition, a message warning of a blocked sensor or a message warning of low visibility will appear in the information display and the alert indicator illuminates in the appropriate mirror(s). The information display warning can be cleared but the alert indicator remains illuminated.

# Driving Aids

When the blockage is removed, the system can be reset in two ways:

- when at least two objects are detected while driving, or
- turn the ignition from on to off, then back on.

If the blockage is still present after the key cycle, the system senses again that it is blocked after driving in traffic.

Reasons for messages being displayed	
The radar surface is dirty or obstructed	Clean the fascia area in front of the radar or remove the obstruction.
The radar surface is not dirty or obstructed	Drive normally in traffic for a few minutes to allow the radar to detect passing vehicles so it can clear the blocked state.
Heavy rainfall/snowfall interferes with the radar signals	No action required. The system automatically resets to an unblocked state once the rainfall or snowfall rate decreases or stops. Do not use BLIS or cross traffic alert in these conditions.

## System Limitations

The BLIS and cross traffic alert systems do have their limitations; situations such as severe weather conditions or debris build-up on the sensor area may limit vehicle detection.

The following are other situations that may limit the BLIS:

- Certain maneuvering of vehicles entering and exiting the blind zone.
- Vehicles passing through the blind zone at very fast rates.
- When several vehicles forming a convoy pass through the blind zone.

The following are other situations that may limit the cross traffic alert system:

- Adjacently parked vehicles or objects obstructing the sensors.
- Approaching vehicles passing at speeds greater than 15 mph (24 km/h).
- Driving in reverse faster than 5 mph (8 km/h).
- Backing out of an angled parking spot.

## False Alerts

**Note:** *If a trailer is connected to the vehicle the BLIS system may detect the trailer causing a false alert. You may want to turn the BLIS off manually.*

# Driving Aids

There may be certain instances when either the BLIS or cross traffic alert systems illuminate the alert indicator with no vehicle in the coverage zone; this is known as a false alert. Some amount of false alerts are normal; they are temporary and self-correct.

## System Errors

If either system senses a problem with the left or right sensor, the BLIS telltale will illuminate and a message will appear in the information display.

All other system faults will only be displayed by a message in the information display.

## Switching the Systems Off and On

One or both systems can be switched off temporarily by using the information display control. See (page 109). When the BLIS is switched off, you will not receive alerts and a telltale illuminates in the information display. The yellow alert indicator in the outside mirror will also flash twice.

**Note:** *The CTA system always switches on whenever the ignition is switched on. However, the BLIS system will remember the last selected on or off setting.*

One or both systems cannot be switched off when MyKey is used. See (page 359).

One or both systems can also be switched off permanently at your authorized dealer. Once switched off, switching it back on must also be done at your authorized dealer.

## STEERING

### Electric Power Steering

#### WARNINGS



The electric power steering system has diagnostic checks that continuously monitor the system to ensure proper operation. When a system error is detected a steering message will appear in the information display.

#### WARNINGS



The electric power steering system has diagnostic checks that continuously monitor the system to ensure proper operation of the electronic system. When an electronic error is detected, a message will be displayed in the information display. If this happens, stop the vehicle in a safe place, and turn off the engine. After at least 10 seconds, reset the system by restarting the engine, and watch the information display for a steering message. If a steering message returns, or returns while driving, take the vehicle to your dealer to have it checked.



Obtain immediate service if a system error is detected. You may not notice any difference in the feel of your steering, but a serious condition may exist. Failure to do so may result in loss of steering control.

Your vehicle has an electric power steering system. There is no fluid reservoir to check or fill.

# Driving Aids

If your vehicle loses electrical power while you are driving (or if you switch the ignition off), you can steer your vehicle manually, but it takes more effort. Extreme continuous steering may increase the effort it takes for you to steer. This occurs to prevent internal overheating and permanent damage to your steering system. If this should occur, you will neither lose the ability to steer your vehicle manually nor will it cause permanent damage. Typical steering and driving maneuvers allows the system to cool and steering assist to return to normal.

## Steering Tips

If the steering wanders or pulls, check for:

- An improperly inflated tire.
- Uneven tire wear.
- Loose or worn suspension components.
- Loose or worn steering components.
- Improper vehicle alignment.

A high crown in the road or high crosswinds may also make the steering seem to wander or pull.

## Adaptive Learning

The electronic power steering system adaptive learning helps correct road irregularities and improves overall handling and steering feel. It communicates with the brake system to help operate advanced stability control and accident avoidance systems. Additionally, whenever the battery is disconnected or a new battery installed, you must drive your vehicle a short distance before the system relearns the strategy and reactivates all systems.

## COLLISION WARNING SYSTEM

### PRINCIPLE OF OPERATION (If Equipped)

 This system is designed to be a supplementary driving aid. It is not intended to replace the driver's attention, and judgment, or the need to apply the brakes. This system does NOT activate the brakes automatically. Failure to press the brake pedal to activate the brakes may result in a collision.

## WARNINGS



The collision warning system with brake support cannot help prevent all collisions. Do not rely on this system to replace driver judgment and the need to maintain distance and speed.

**Note:** *The system does not detect, warn or respond to potential collisions with vehicles to the rear or sides of the vehicle.*

**Note:** *The collision warning system is active at speeds above approximately 5 mph (8 km/h).*



E156130

This system is designed to alert the driver of certain collision risks. A radar detects if your vehicle is rapidly approaching another vehicle traveling in the same direction as yours.

# Driving Aids

## Using the Collision Warning System

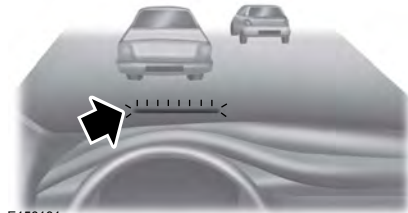

E156131

If it is, a red warning light illuminates and an audible warning chime sounds.

The brake support system assists the driver in reducing the collision speed by charging the brakes. If the risk of collision further increases after the warning light illuminates, the brake support prepares the brake system for rapid braking. This may be apparent to the driver. The system does not automatically activate the brakes but, if the brake pedal is pressed, full force braking is applied even if the brake pedal is lightly pressed.

### WARNING



The collision warning system's brake support can only help reduce the speed at which a collision occurs if the driver applies the vehicle's brakes. The brake pedal must be pressed just like any typical braking situation.

The warning system sensitivity can be adjusted to one of three possible settings by using the information display control. See (page 109).

**Note:** *If collision warnings are perceived as being too frequent or disturbing then the warning sensitivity can be reduced, though the manufacturer recommends using the highest sensitivity setting where possible. Setting lower sensitivity would lead to fewer and later system warnings. See (page 109).*

## Blocked Sensors



E145632

If a message regarding a blocked sensor appears in the information display, the radar signals from the sensor have been obstructed. The sensors are located behind a fascia cover near the driver side of the lower grille. When the sensors are obstructed, a vehicle ahead cannot be detected and the collision warning system does not function. The following table lists possible causes and actions for this message being displayed.

# Driving Aids

Cause	Action
The surface of the radar in the grille is dirty or obstructed in some way	Clean the grille surface in front of the radar or remove the object causing the obstruction
The surface of the radar in the grille is clean but the message remains in the display	Wait a short time. It may take several minutes for the radar to detect that it is no longer obstructed
Heavy rain, spray, snow, or fog is interfering with the radar signals	The collision warning system is temporarily disabled. Collision warning should automatically reactivate a short time after the weather conditions improve
Swirling water, or snow or ice on the surface of the road may interfere with the radar signals	The collision warning system is temporarily disabled. Collision warning should automatically reactivate a short time after the weather conditions improve

## System Limitations

### WARNING



The collision warning system's brake support can only help reduce the speed at which a collision occurs if the driver applies the vehicle's brakes. The brake pedal must be pressed just like any typical braking situation.

Due to the nature of radar technology, there may be certain instances where vehicles do not provide a collision warning. These include:

- Stationary vehicles or vehicles moving below 6 mph (10 km/h).
- Pedestrians or objects in the roadway.
- Oncoming vehicles in the same lane.
- Severe weather conditions (see blocked sensor section).

- Debris build-up on the grille near the headlamps (see blocked sensor section).
- Small distance to vehicle ahead.
- Steering wheel and pedal movements are large (very active driving style).
-

# Driving Aids

---

If the front end of the vehicle is hit or damaged, the radar sensing zone may be altered causing missed or false collision warnings. See your authorized dealer to have your collision warning radar checked for proper coverage and operation.

## DRIVE CONTROL

### LINCOLN DRIVE CONTROL

Lincoln Drive Control delivers the Lincoln driving experience through a suite of sophisticated electronic vehicle systems. These systems continuously monitor your driving inputs and the road conditions to optimize ride comfort, steering, handling, powertrain response and sound. You can preset your preferences for these systems within the information display. Lincoln Drive Control will respond to your preferences based on what gear position you select. This provides a single location to control multiple systems performance settings.

Lincoln Drive Control consists of the following systems:

- Continuously controlled damping dynamically adjusts the shock absorbers stiffness in real time to match the road surface and driver inputs. This system continuously monitors your vehicle's motion (roll, pitch, bounce), suspension position, load, speed, road conditions, and steering to adjust the suspension damping for optimal vehicle control.
- Electronically power-assisted steering adjusts steering effort and feel based on your vehicle speed and your inputs.
- Active noise control utilizes your vehicle electronics to enhance the acoustic experience.
- Electronic stability control and traction control maintain your vehicle control in adverse conditions or high performance driving.
- Electronic throttle control enhances the powertrain response to your inputs.
- Comfort – Provides a more relaxed driving experience, maximizing comfort. Your steering effort decreases and the suspension movement is more fluid. Comfort mode is ideal when you desire enhanced traveling comfort.
- Normal – Delivers a balanced combination of comfortable, controlled ride and confident handling. This mode provides an engaging drive experience and a direct connection to the road without sacrificing any of the composure demanded from a luxury vehicle.
- Sport – Provides a sportier driving experience. The suspension stiffens, with an emphasis on handling and control. The engine responds more directly to your inputs and takes on a more powerful tone. Sport mode is ideal for use during more spirited driving.

These systems have a range of modes which you can choose from in order to customize your ideal driving experience:

### Using Lincoln Drive Control

You can configure which of the Drive Control modes are active when your vehicle is in drive (D). The configuration remains active until modified from the main menu on the information display.

# Driving Aids

---

To change your vehicle's Drive Control settings from the main menu on the information display:

1. Choose Settings.
2. Choose Vehicle.
3. Choose Drive Control.
4. Choose from Comfort, Normal, or Sport modes as your preferred setting.

**Note:** *Not all settings may be available.*

**Note:** *Lincoln Drive Control has diagnostic checks that continuously monitor the system to ensure proper operation. Certain types of system errors will gray out the mode selections within the information display, preventing you from changing states when the gear position is changed. Other types of errors will produce a temporary message that states Drive Control Malfunction. If either condition persists for multiple key cycles, have your vehicle checked by an authorized dealer.*

# Load Carrying

## LOAD LIMIT

### Vehicle Loading - with and without a Trailer

This section will guide you in the proper loading of your vehicle, trailer or both, to keep your loaded vehicle weight within its design rating capability, with

or without a trailer. Properly loading your vehicle will provide maximum return of vehicle design performance. Before loading your vehicle, familiarize yourself with the following terms for determining your vehicle's weight ratings, with or without a trailer, from the vehicle's Tire Label or Safety Compliance Certification Label:

**Base Curb Weight** - is the weight of the vehicle including a full tank of fuel and all standard equipment. It does not include passengers, cargo, or optional equipment.

**Vehicle Curb Weight** - is the weight of your new vehicle when you picked it up from your authorized dealer plus any aftermarket equipment.

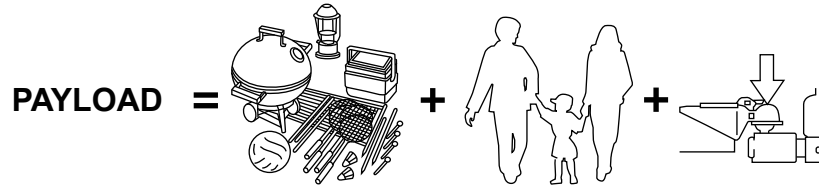

E143816

**Payload** - is the combined weight of cargo and passengers that the vehicle is carrying. The maximum payload for your vehicle can be found on the Tire Label on the B-Pillar or the edge of the driver door (vehicles exported outside the US and Canada may not have a Tire

Label). Look for **“THE COMBINED WEIGHT OF OCCUPANTS AND CARGO SHOULD NEVER EXCEED XXX kg OR XXX lb.”** for maximum payload. The payload listed on the Tire Label is the maximum payload for the vehicle as built by the assembly plant. If you install any

aftermarket or authorized-dealer installed equipment on the vehicle, you must subtract the weight of the equipment from the payload listed on the Tire Label in order to determine the new payload.

# Load Carrying

## WARNING

 The appropriate loading capacity of your vehicle can be limited either by volume capacity (how much space is available) or by payload capacity (how much weight the vehicle should carry). Once you have reached the maximum payload of your vehicle, do not add more cargo, even if there is space available. Overloading or improperly loading your vehicle can contribute to loss of vehicle control and vehicle rollover.

**Example only:**

TIRE AND LOADING INFORMATION				
SEATING CAPACITY		TOTAL 5	FRONT 2	REAR 3
The combined weight of occupants and cargo should never exceed : <b>XXX kg or XXX lbs.</b>				
XXX XXXXXXXXXX	TIRE	SIZE	COLD TIRE PRESSURE	SEE OWNERS MANUAL FOR ADDITIONAL INFORMATION XXXXXXXXXXXXXX
	FRONT	LT225/75R 16.5E	200 KPA, 29 PSI	
	REAR	LT225/75R 16.5E	200 KPA, 29 PSI	
	SPARE	T145/80D16 P225/60R17	420 KPA, 60 PSI 200 KPA, 29 PSI	

E142516

# Load Carrying

**TIRE AND LOADING INFORMATION**  
**RENSEIGNEMENTS SUR LES PNEUS ET LE CHARGEMENT**

SEATING CAPACITY | TOTAL 5 | FRONT 2 | REAR 3  
 NOMBRE DE PLACES | TOTAL 5 | AVANT 2 | ARRIÈRE 3

The combined weight of occupants and cargo should never exceed 492 kg or 1085 lbs.  
 Le poids total des occupants et du chargement ne doit jamais dépasser 492 kg ou 1085 lb.

TIRE PNEU	SIZE DIMENSIONS	COLD TIRE PRESSURE PRESSION DES PNEUS A FROID	SEE OWNER'S MANUAL FOR ADDITIONAL INFORMATION
FRONT AVANT	P235/70R16	240 KPA, 35 PSI	VOIR LE MANUEL DE L'USAGER POUR PLUS DE RENSEIGNEMENTS
REAR ARRIÈRE	P235/70R16	240 KPA, 35 PSI	
SPARE DE SECOURS	T145/90R17	415 KPA, 60 PSI	

E142517

**CARGO**

**=**



**+**

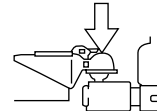

E143817

# Load Carrying

**Cargo Weight** - includes all weight added to the Base Curb Weight, including cargo and optional equipment. When towing, trailer tongue load or king pin weight is also part of cargo weight.

**GAW (Gross Axle Weight)** - is the total weight placed on each axle (front and rear) including vehicle curb weight and all payload.

**GAWR (Gross Axle Weight Rating)** - is the maximum allowable weight that can be carried by a single axle (front or rear). These numbers are shown on the Safety Compliance Certification Label. The label shall be affixed to either the door hinge pillar, door-latch post, or the door edge that meets the door-latch post, next to the driver's seating position. **The total load on each axle must never exceed its Gross Axle Weight Rating.**

**Note:** For trailer towing information refer to the *RV and Trailer Towing Guide* available at an authorized dealer.

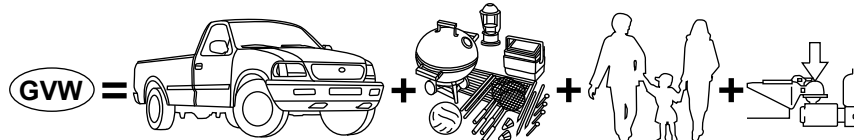

E143818

**GVW (Gross Vehicle Weight)** - is the Vehicle Curb Weight, plus cargo, plus passengers.

# Load Carrying

**GVWR (Gross Vehicle Weight Rating)** - is the maximum allowable weight of the fully loaded vehicle (including all options, equipment, passengers and cargo). It is shown on the Safety Compliance Certification Label. The label shall be affixed to either the door

hinge pillar, door-latch post, or the door edge that meets the door-latch post, next to the driver's seating position. **The Gross Vehicle Weight must never exceed the Gross Vehicle Weight Rating.**

**Example only:**

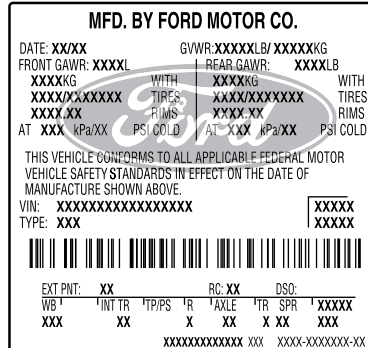

E142523

# Load Carrying

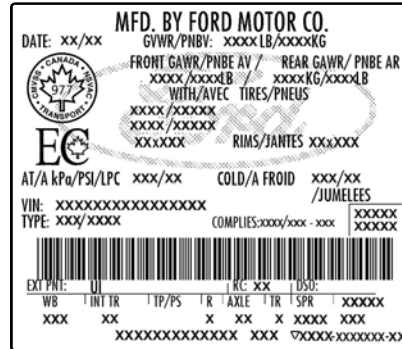

E142524

## WARNING



Exceeding the Safety Compliance Certification Label vehicle weight rating limits could result in substandard vehicle handling or performance, engine, transmission and/or structural damage, serious damage to the vehicle, loss of control and personal injury.

# Load Carrying

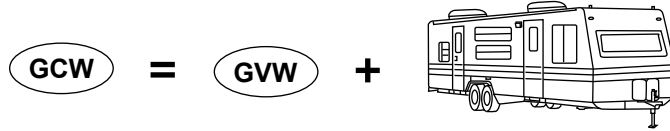

E143819

**GCW (Gross Combined Weight)** - is the Gross Vehicle Weight plus the weight of the fully loaded trailer.

**GCWR (Gross Combined Weight Rating)** - is the maximum allowable weight of the vehicle and the loaded trailer, including all cargo and passengers, that the vehicle can handle without risking damage. (Important: The towing vehicle's braking system is rated for operation at Gross Vehicle Weight Rating, not at Gross Combined Weight Rating.) Separate functional brakes should be used for safe control of towed vehicles and for trailers where the Gross

Combined Weight of the towing vehicle plus the trailer exceed the Gross Vehicle Weight Rating of the towing vehicle. **The Gross Combined Weight must never exceed the Gross Combined Weight Rating.**

**Maximum Loaded Trailer Weight** - is the highest possible weight of a fully loaded trailer the vehicle can tow. It assumes a vehicle with mandatory options, driver and front passenger weight (150 pounds [68 kilograms] each), no cargo weight (internal or external) and a tongue load of 10–15%

(conventional trailer) or king pin weight of 15–25% (fifth wheel trailer). Consult an authorized dealer (or the RV and Trailer Towing Guide available at an authorized dealer) for more detailed information.

**Tongue Load or Fifth Wheel King Pin Weight** - refers to the amount of the weight that a trailer pushes down on a trailer hitch.

**Examples:** For a 5000 pound (2268 kilogram) conventional trailer, multiply 5000 by 0.10 and 0.15 to obtain a proper tongue load range of 500 to 750 pounds (227 to 340 kilograms). For an 11500 pound (5216 kilogram) fifth wheel trailer, multiply by 0.15 and 0.25 to obtain a proper king pin load range of 1725 to 2875 pounds (782 to 1304 kilograms).

# Load Carrying

## WARNINGS



Do not exceed the GVWR or the GAWR specified on the Safety Compliance Certification Label.



Do not use replacement tires with lower load carrying capacities than the original tires because they may lower the vehicle's GVWR and GAWR limitations. Replacement tires with a higher limit than the original tires do not increase the GVWR and GAWR limitations.



Exceeding any vehicle weight rating limitation could result in serious damage to the vehicle and/or personal injury.

### Steps for determining the correct load limit:

1. Locate the statement "The combined weight of occupants and cargo should never exceed XXX kg or XXX lb." on your vehicle's placard.
2. Determine the combined weight of the driver and passengers that will be riding in your vehicle.
3. Subtract the combined weight of the driver and passengers from XXX kg or XXX lb.
4. The resulting figure equals the available amount of cargo and luggage load capacity. For example, if the "XXX" amount equals 1,400 lb. and there will be five 150 lb. passengers in your vehicle, the amount of available cargo and luggage load capacity is 650 lb. (1400-750 (5 x 150) = 650 lb.)
5. Determine the combined weight of luggage and cargo being loaded on the vehicle. That weight may not safely exceed the available cargo and luggage load capacity calculated in Step 4.
6. If your vehicle will be towing a trailer, load from your trailer will be transferred to your vehicle. Consult this manual to determine how this reduces the available cargo and luggage load capacity of your vehicle.

The following gives you a few examples on how to calculate the available amount of cargo and luggage load capacity:

\*Suppose your vehicle has a 1400-pound (635-kilogram) cargo and luggage capacity. You decide to go golfing. Is there enough load capacity to carry you, four of your friends and all the golf bags? You and four friends average 220 pounds (99 kilograms) each and the golf bags weigh approximately 30 pounds (13.5 kilograms) each. The calculation would be:  $1400 - (5 \times 220) - (5 \times 30) = 1400 - 1100 - 150 = 150$  pounds. Yes, you have enough load capacity in your vehicle to transport four friends and your golf bags. In metric units, the calculation would be:  $635 \text{ kilograms} - (5 \times 99 \text{ kilograms}) - (5 \times 13.5 \text{ kilograms}) = 635 - 495 - 67.5 = 72.5$  kilograms.

# Load Carrying

---

\*Suppose your vehicle has a 1400-pound (635-kilogram) cargo and luggage capacity. You and one of your friends decide to pick up cement from the local home improvement store to finish that patio you have been planning for the past two years. Measuring the inside of the vehicle with the rear seat folded down, you have room for twelve 100-pound (45-kilogram) bags of cement. Do you have enough load capacity to transport the cement to your home? If you and your friend each weigh 220 pounds (99 kilograms), the calculation would be:  $1400 - (2 \times 220) - (12 \times 100) = 1400 - 440 - 1200 = -240$  pounds. No, you do not have enough cargo capacity to carry that much weight. In metric units, the calculation would be:  $635 \text{ kilograms} - (2 \times 99 \text{ kilograms}) - (12 \times 45 \text{ kilograms}) = 635 - 198 - 540 = -103$  kilograms. You will need to reduce the load weight by at least 240 pounds (104 kilograms). If you remove three 100-pound (45-kilogram) cement bags, then the load calculation would be:  $1400 - (2 \times 220) - (9 \times 100) = 1400 - 440 - 900 = 60$  pounds. Now you

have the load capacity to transport the cement and your friend home. In metric units, the calculation would be:  $635 \text{ kilograms} - (2 \times 99 \text{ kilograms}) - (9 \times 45 \text{ kilograms}) = 635 - 198 - 405 = 32$  kilograms.

The above calculations also assume that the loads are positioned in your vehicle in a manner that does not overload the Front or the Rear Gross Axle Weight Rating specified for your vehicle on the Safety Compliance Certification Label. The label shall be affixed to either the door hinge pillar, door-latch post, or the door edge that meets the door-latch post, next to the driver's seating position.

# Towing

## TOWING A TRAILER

### WARNING

 Never tow a trailer with an MKZ Hybrid. This powertrain is not designed to tow.

## TRANSPORTING THE VEHICLE

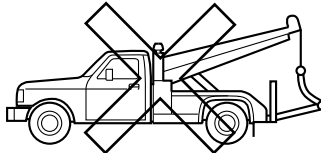
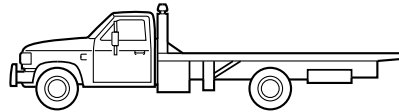
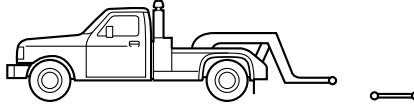

E143886

If you need to have your vehicle towed, contact a professional towing service or, if you are a member of a roadside assistance program, your roadside assistance service provider.

We recommend the use of a wheel lift and dollies or flatbed equipment to tow your vehicle. Do not tow with a slingbelt. Ford Motor Company has not approved a slingbelt towing procedure. Vehicle damage may occur if towed incorrectly, or by any other means.

Ford Motor Company produces a towing manual for all authorized tow truck operators. Have your tow truck operator refer to this manual for proper hook-up and towing procedures for your vehicle.

The front wheels (drive wheels) must be on a tow dolly when towing your vehicle from the rear using wheel lift equipment. This prevents damage to the transmission.

We recommend placing the rear wheels on a tow dolly when towing your vehicle from the front using wheel lift equipment. This prevents damage to the rear fascia.

# Towing

## TOWING THE VEHICLE ON FOUR WHEELS

### Emergency Towing

In the event your vehicle becomes disabled (without access to wheel dollies, car-hauling trailer, or flatbed transport vehicle), it can be flat-towed (all wheels on the ground, regardless of the powertrain/transmission configuration) under the following conditions:

- The vehicle is facing forward so that it is towed in a forward direction.
- The transmission gear shift lever is placed in position **N**. If the transmission gear shift lever cannot be moved to position **N**, it may need to be overridden. See **Automatic Transmission** (page 187).
- Maximum speed is 35 mph (56 km/h).
- Maximum distance is 50 miles (80 kilometers).

### Recreational Towing

**Note:** Put your climate control system in recirculated air mode to prevent exhaust fumes from entering the vehicle. See **Climate Control** (page 139).

Follow these guidelines if you have a need for recreational (RV) towing. An example of recreational towing would be towing your vehicle behind a motorhome. These guidelines are designed to ensure that your transmission is not damaged.

Your vehicle can be towed with all four wheels on the ground using the Neutral Tow feature, or with all four wheels off the ground using a vehicle transport trailer. If you are using a vehicle transport trailer, follow the instruction specified by the equipment provider.

### Neutral Tow

If you tow your vehicle with all four wheels on the ground:

- Tow only in the forward direction.
- Release the parking brake.

- Place the vehicle in Neutral Tow mode by doing the following:
  - Put the ignition in accessory mode (ignition on, engine off). See **Keyless Starting** (page 163).
  - Select **Neutral Tow** in the information display.
  - When prompted by the information display, press the brake pedal and select Neutral on the transmission. Make sure the parking brake is off. If done successfully, **Neutral Tow Engaged** appears in the display.
  - Shut the ignition off. See **Keyless Starting** (page 163). If the process is completed successfully, the **N** on the transmission slowly blinks and "Neutral tow engaged" appears in the information display.
- Do not exceed 70 mph (113 km/h).
- Start the engine and allow it to run for one minute at the beginning of each day. With the engine running and your foot on the brake, shift into position **D** and then into position **R** before shifting back into position **N**.

# Driving Hints

---

## BREAKING-IN

You need to break in new tires for approximately 300 miles (480 kilometers). During this time, your vehicle may exhibit some unusual driving characteristics. The engine also needs to break in. Avoid hard accelerations and driving too fast for the first 1000 miles (1600 kilometers). If possible, avoid carrying heavy loads up steep grades during the break-in period.

## ECONOMICAL DRIVING

Fuel economy is affected by several things such as how you drive, the conditions you drive under and how you maintain your vehicle.

There are some things to keep in mind that may improve your fuel economy:

- Accelerate and slow down in a smooth, moderate fashion.
- Drive at steady speeds.
- Anticipate stops; slowing down may eliminate the need to stop.

- Combine errands and minimize stop-and-go driving.
  - When running errands, go to the furthest destination first and then work your way back home.
- Close the windows for high-speed driving.
- Drive at reasonable speeds. (Traveling at 65 mph/105 kph uses about 15% less fuel than traveling at 75 mph/121 kph).
- Keep the tires properly inflated and use only the recommended size.
- Use the recommended engine oil.
- Perform all regularly scheduled maintenance.

There are also some things you may want to avoid doing because they reduce your fuel economy:

- Avoid sudden or hard accelerations.
- Avoid revving the engine before turning off the car.
- Avoid long idle periods.
- Do not warm up your vehicle on cold mornings.

- Reduce the use of air conditioning and heat.
- Avoid using speed control in hilly terrain.
- Do not rest your foot on the brake pedal while driving.
- Avoid carrying unnecessary weight (approximately 1 mpg [0.4 kilometers/liter] is lost for every 400 lbs [180 kilograms] of weight carried).
- Avoid adding particular accessories to your vehicle (e.g. bug deflectors, rollbars/light bars, running boards, ski racks).
- Avoid driving with the wheels out of alignment.

## DRIVING THROUGH WATER

### WARNING



Do not drive through flowing or deep water as you may lose control of your vehicle.

**Note:** *Driving through standing water can cause vehicle damage.*

# Driving Hints

**Note:** *Engine damage can occur if water enters the air filter.*

Before driving through standing water, check the depth. Never drive through water that is higher than the bottom of the front rocker area of your vehicle.

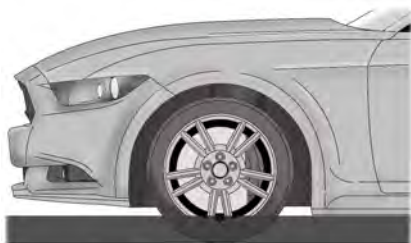

E176360

When driving through standing water, drive very slowly and do not stop your vehicle. Your brake performance and traction may be limited. After driving through water and as soon as it is safe to do so:

- Lightly press the brake pedal to dry the brakes and to check that they work.
- Check that the horn works.

- Check that the exterior lights work.
- Turn the steering wheel to check that the steering power assist works.

## FLOOR MATS

### WARNINGS

 Always use floor mats that are designed to fit the foot well of your vehicle. Only use floor mats that leave the pedal area unobstructed. Only use floor mats that are firmly secured to retention posts so that they cannot slip out of position and interfere with the pedals or impair safe operation of your vehicle in other ways.

 Pedals that cannot move freely can cause loss of vehicle control and increase the risk of serious personal injury.

 Always make sure that the floor mats are properly attached to the retention posts in the carpet that are supplied with your vehicle. Floor mats must be properly secured to both retention posts to make sure mats do not shift out of position.

### WARNINGS

 Never place floor mats or any other covering in the vehicle foot well that cannot be properly secured to prevent them from moving and interfering with the pedals or the ability to control the vehicle.

 Never place floor mats or any other covering on top of already installed floor mats. Floor mats should always rest on top of vehicle carpeting surface and not another floor mat or other covering. Additional floor mats or any other covering will reduce the pedal clearance and potentially interfere with pedal operation.

 Check attachment of floor mats on a regular basis. Always properly reinstall and secure floor mats that have been removed for cleaning or replacement.

 Always make sure that objects cannot fall into the driver foot well while the vehicle is moving. Objects that are loose can become trapped under the pedals causing a loss of vehicle control.

# Driving Hints

---

## WARNINGS



Failure to properly follow floor mat installation or attachment instructions can potentially cause interference with pedal operation causing a loss of vehicle control.



E142666

To install floor mats, position the floor mat so that the eyelet is over the retention post and press down to lock in.

To remove the floor mat, reverse the installation procedure.

# Roadside Emergencies

---

## ROADSIDE ASSISTANCE

### Vehicles Sold In the United States: Getting Roadside Assistance

If you ever need help on the road, the Lincoln Motor Company is there for you with nationwide, 24-hours-a-day, seven-days-a-week assistance.

The service is available:

- Throughout the life of the vehicle for original owners.
- For six years or 70,000 miles (112,654 km) (whichever comes first) within the extended powertrain warranty coverage period for subsequent owners.
- For the coverage period listed on the Roadside Assistance Card included in your Owner's Manual portfolio.

This complimentary Roadside Assistance program is separate from the New Vehicle Limited Warranty, and includes:

- A flat tire change with a good spare (except vehicles supplied with a tire inflation kit).
- Battery jump start.

- Lock-out assistance (key replacement cost is the client's responsibility).
- Fuel delivery — independent service contractors, if not prohibited by state, local or municipal law shall deliver up to 2 gal (7.6 L) of gasoline or 5 gal (19 L) of diesel fuel to a disabled vehicle. Roadside Assistance limits fuel delivery service to two no-charge occurrences within a 12-month period.
- Winch out — available within 100 ft (30 m) of a paved or county maintained road, no recoveries.
- Towing — Lincoln eligible vehicles to the client's selling or preferred dealer within 100 miles (161 km) of the disablement location or to the nearest Lincoln dealer. If a client requests a tow to a selling or preferred dealer that is more than 100 miles (161 km) from the disablement location, the client shall be responsible for any mileage costs in excess of 100 miles (161 km).

Roadside Assistance will include up to \$200 coverage for a towed trailer if the disabled eligible vehicle requires service at the nearest authorized dealer. If the towing vehicle is operational but the trailer is not, then the trailer does not qualify for any roadside services.

### Vehicles Sold In the United States: Using Roadside Assistance

United States Lincoln vehicle clients who require Roadside Assistance, call 1-800-521-4140.

If you need to arrange roadside assistance for yourself, Ford Motor Company will reimburse a reasonable amount for towing to the nearest Lincoln dealership within 100 miles (161 km). To obtain reimbursement information, United States Lincoln vehicle clients, call 1-800-521-4140. Ford Motor Company will ask you to submit your original receipts.

# Roadside Emergencies

## Vehicles Sold In Canada: Getting Roadside Assistance

Canadian clients who require roadside assistance, call 1-800-387-9333.

## Vehicles Sold In Canada: Using Roadside Assistance

Canadian Roadside coverage and benefits may differ from the United States coverage. Please refer to your warranty information or visit our website at [www.lincolncanada.com](http://www.lincolncanada.com) for information on Canadian services and benefits.

Canadian clients who need to obtain roadside information, call 1-800-387-9333 or visit our website at [www.lincolncanada.com](http://www.lincolncanada.com).

## HAZARD WARNING FLASHERS

**Note:** *If used when the vehicle is not running, the battery will lose charge. There may be insufficient power to restart your vehicle.*



The hazard warning button is located on the instrument panel. Use it when your vehicle is creating a safety hazard for other motorists.

- Press the button to turn on the hazard warning function, and the front and rear direction indicators will flash.
- Press the button again to turn them off.

## FUEL SHUTOFF

### WARNING



Failure to inspect and, if necessary, repair fuel leaks after a collision may increase the risk of fire and serious injury. Ford Motor Company recommends that the fuel system be inspected by an authorized dealer after any collision.

In the event of a moderate to severe collision, this vehicle has a fuel pump shut-off feature that stops the flow of fuel to the engine. Not every impact will cause a shut-off.

Should your vehicle shut off after a collision, you may restart your vehicle.

For vehicles equipped with a key system:

1. Switch off the ignition.
2. Switch on the ignition.
3. Check the information display for the Ready to Drive light as the gasoline engine may not start, but the electric motor may be running. If you do not see the Ready to Drive light, repeat Steps 1 and 2 up to two more times.

For vehicles equipped with a push button start system:

1. Press the push button start to switch off the ignition.
2. Press the brake pedal and press the push button start to switch on the ignition.
3. Check the information display for the Ready to Drive light as the gasoline engine may not start, but the electric motor may be running. If you do not see the Ready to Drive light, repeat Steps 1 and 2 up to two more times.

# Roadside Emergencies

---

**Note:** When you try to restart your vehicle after a fuel shutoff, the vehicle makes sure that the electrical system is safe to restart. Once your vehicle determines that the electrical system is safe, then the vehicle will allow you to restart.

**Note:** In the event that your vehicle does not restart after your third attempt, contact an authorized dealer.

## JUMP STARTING THE VEHICLE

### WARNINGS

 The gases around the battery can explode if exposed to flames, sparks, or lit cigarettes. An explosion could result in injury or vehicle damage.

 Batteries contain sulfuric acid which can burn skin, eyes and clothing, if contacted.

---

Do not attempt to push-start your automatic transmission vehicle. Automatic transmissions do not have push-start capability. Attempting to push-start a vehicle with an automatic transmission may cause transmission damage.

### Preparing Your Vehicle

**Note:** Use only a 12-volt supply to start your vehicle.

**Note:** Do not disconnect the battery of the disabled vehicle as this could damage the vehicle's electrical system.

1. Park the booster vehicle close to the hood of the disabled vehicle making sure the two vehicles do not touch. Set the parking brake on both vehicles and stay clear of the engine cooling fan and other moving parts.

2. Check all battery terminals and remove any excessive corrosion before you attach the battery cables. Ensure that vent caps are tight and level.
3. Turn the heater fan on in both vehicles to protect from any electrical surges. Turn all other accessories off.

### Connecting the Jumper Cables

Your vehicle has two battery prongs that are accessible from under the hood, even though the actual battery is located in the trunk. Your vehicle can be jumped the same way conventional vehicles can be using these prongs. The illustration below shows the two connector prongs used for jump-starting your vehicle.

# Roadside Emergencies

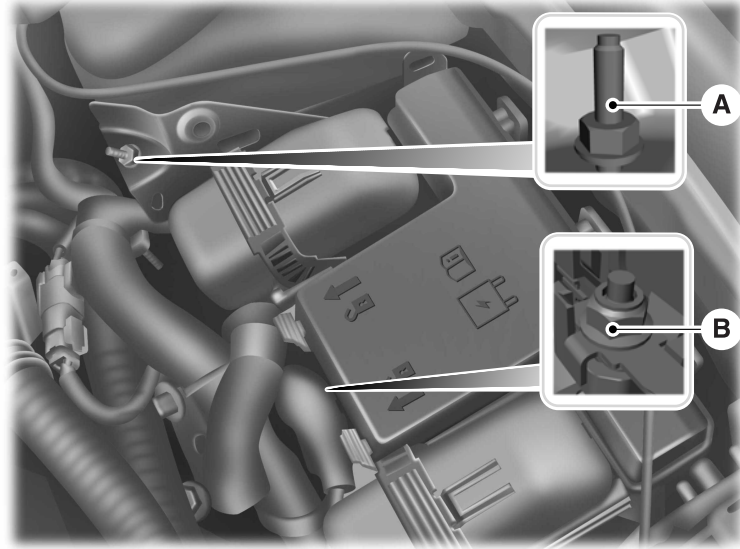

E175005

A. Negative prong (-)

B. Positive prong (+)

**Note:** In the illustration, the vehicle on the bottom is used to designate the assisting (boosting) battery.

**Note:** Remove the red cap from the positive prong (B) on your vehicle before connecting the cables.

# Roadside Emergencies

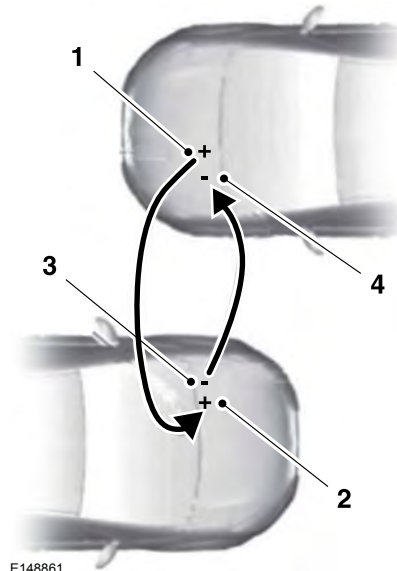

E148861

1. Connect the positive (+) jumper cable to the positive (+) prong (B) of the discharged battery.

2. Connect the other end of the positive (+) cable to the positive (+) terminal of the assisting battery.
3. Connect the negative (-) cable to the negative (-) terminal of the assisting battery.
4. Make the final connection of the negative (-) cable to the negative (-) prong (A) of your vehicle.

**Note:** Do not attach the negative (-) cable to fuel lines, engine rocker covers, the intake manifold or electrical components as grounding points.

## WARNING



Do not connect the end of the second cable to the negative (-) terminal of the battery to be jumped. A spark may cause an explosion of the gases that surround the battery.

Ensure that the cables are clear of fan blades, belts, moving parts of both engines, or any fuel delivery system parts.

## Jump Starting

1. Start the booster vehicle and press the accelerator pedal moderately.
2. Start the disabled vehicle. Check the instrument cluster for the Ready to Drive light as the gasoline engine may not start, but the electric motor may be running.
3. Once you start the disabled vehicle, run both vehicles for an additional three minutes before disconnecting the jumper cables.

## Removing the Jumper Cables

Remove the jumper cables in the reverse order that they were connected.

**Note:** In the illustration, the vehicle on the bottom is used to designate the assisting (boosting) battery.

# Roadside Emergencies

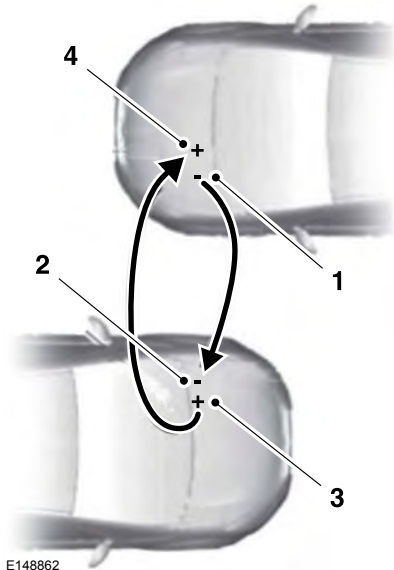

E148862

1. Remove the jumper cable from the ground metal surface.
2. Remove the jumper cable on the negative (-) terminal of the booster vehicle's battery.

3. Remove the jumper cable from the positive (+) terminal of the booster vehicle's battery.
4. Remove the jumper cable from the positive (+) terminal of the disabled vehicle's battery.

After disconnecting the jumper cables, let the disabled vehicle sit in Ready to Drive mode for several minutes to charge the 12V battery. The disabled vehicle can charge the 12V battery even if the gasoline engine may be off. The 12V battery will receive power from the high-voltage battery instead.

## COLLISION, DAMAGE OR FIRE EVENT

### Guidance for Ford Motor Company Electric and Hybrid-Electric Vehicles Equipped With High Voltage Batteries

#### (Vehicle Owner/Operator/General Public) Electric and Hybrid-Electric Vehicle Considerations

#### In the event of damage or fire involving an electric vehicle (EV) or hybrid-electric vehicle (HEV):

- Always assume the high-voltage battery and associated components are energized and fully charged.
- Exposed electrical components, wires and high-voltage batteries present potential high-voltage shock hazards.
- Venting/off-gassing high-voltage battery vapors are potentially toxic and flammable.
- Physical damage to the vehicle or high-voltage battery may result in immediate or delayed release of toxic, flammable gases and fire.

# Roadside Emergencies

---

## Vehicle Information and General Safety Practices

- Know the make and model of your vehicle.
- Review the owner's manual and become familiar with your vehicle's safety information and recommended safety practices.
- Do not attempt to repair damaged electric and hybrid-electric vehicles yourself. Contact an authorized Ford Dealer or vehicle manufacturer representative for service.

## Crashes

A crash or impact significant enough to require an emergency response for conventional vehicles would also require the same response for an electric or hybrid-electric vehicle.

## *If possible*

- Move your car to a safe, nearby location and remain on the scene.
- Roll down the windows before shutting your vehicle off.
- Place your vehicle in Park, set the parking brake, turn off the vehicle, activate the hazard lights, and move your key(s) at least 16 feet (5 meters) away from the vehicle.

## *Always*

- Call 911 if assistance is needed and advise that an electric or hybrid-electric vehicle is involved.
- Do not touch exposed electrical components or the engine compartment, as a shock hazard may exist.
- Avoid contact with leaking fluids and gases, and remain out of the way of oncoming traffic until emergency responders arrive.
- When emergency responders arrive, tell them that the vehicle involved is an electric vehicle or hybrid vehicle.

## Fires

As with any vehicle, call 911 immediately if you see sparks, smoke or flames coming from the vehicle.

- Exit the vehicle immediately.
- Advise 911 that an electric or hybrid-electric vehicle is involved.
- As with any vehicle fire, do not inhale smoke, vapors or gas from the vehicle, as they may be hazardous.
- Remain a safe distance upwind and uphill from the vehicle fire.
- Stay out of the roadway and stay out of the way of any oncoming traffic while awaiting the arrival of emergency responders.

## Post-Incident

- Do not store a severely damaged vehicle with a lithium-ion battery inside a structure or within 50 feet (15 meters) of any structure or vehicle.
- Make sure that passenger and cargo compartments remain ventilated (i.e., open window, door, or trunk).

# Roadside Emergencies

---

- For vehicles in the United States, notify Ford Motor Company 1-800-392-3673 (then follow the prompts on the voice response menu), an authorized Ford dealer or service center as soon as possible as there may be other steps to secure and discharge the high-voltage battery.
- For vehicles in Canada, notify Ford Motor Company 1-800-565-3673 (then follow the prompts on the voice response menu), an authorized Ford dealer or service center as soon as possible as there may be other steps to secure and discharge the high-voltage battery.
- Call 911 if you observe leaking fluids, sparks, smoke or flames, or hear gurgling or bubbling from the high-voltage battery.

## POST-CRASH ALERT SYSTEM

The system flashes the turn signal lamps and sounds the horn (intermittently) in the event of a serious impact that deploys an airbag (front, side, side curtain or Safety Canopy) or the safety belt pretensioners.

The horn and lamps will turn off when:

- The hazard control button is pressed
- The panic button (if equipped) is pressed on the remote entry transmitter
- Your vehicle runs out of power

## Spinout Detection

If a spinout is detected, the vehicle comes to a stop and the hazard warning flashers come on. The message **Spinout Detected Hazards Activated** will also appear on the instrument cluster. The message may not appear if your vehicle runs out of power.

Once the hazard warning flashers have been activated, you can turn them off by:

- Pressing the hazard warning flasher button
- Pressing the remote control unlock button
- Pressing the remote control panic button
- Cycling the ignition on and off twice

# Customer Assistance

---

## GETTING THE SERVICES YOU NEED

Warranty repairs to your vehicle must be performed by an authorized dealer. While any authorized dealer handling your vehicle line will provide warranty service, we recommend you return to your selling authorized dealer who wants to ensure your continued satisfaction.

Please note that certain warranty repairs require special training and equipment, so not all authorized dealers are authorized to perform all warranty repairs. This means that, depending on the warranty repair needed, you may have to take your vehicle to another authorized dealer.

A reasonable time must be allowed to perform a repair after taking your vehicle to the authorized dealer. Repairs will be made using Ford or Motorcraft parts, or remanufactured or other parts that are authorized by Ford.

## Away From Home

If you are away from home when your vehicle needs service, contact the Ford Customer Relationship Center or use the online resources listed below to find the nearest authorized dealer.

In the United States:

### Mailing address

Ford Motor Company  
Customer Relationship Center  
P.O. Box 6248  
Dearborn, MI 48121

### Telephone

1-800-521-4140  
(TDD for the hearing impaired:  
1-800-232-5952)

### Online

Additional information and resources are available online at [www.lincolnowner.com](http://www.lincolnowner.com)

These are some of the items that can be found online:

- U.S. dealer locator by Dealer Name, City/State, or Zip Code
- Owner Manuals
- Maintenance Schedules
- Recalls
- Ford Extended Service Plans
- Ford Genuine Accessories
- Service specials and promotions.

In Canada:

### Mailing address

Lincoln Customer Relationship Centre  
Ford Motor Company of Canada, Limited  
P.O. Box 2000  
Oakville, Ontario L6J 5E4

### Telephone

1-800-387-9333

### Online

[www.ford.ca](http://www.ford.ca)

# Customer Assistance

---

## Additional Assistance

If you have questions or concerns, or are unsatisfied with the service you are receiving, follow these steps:

1. Contact your Sales Representative or Service Advisor at your selling/servicing authorized dealer.
2. If your inquiry or concern remains unresolved, contact the Sales Manager, Service Manager or Customer Relations Manager.
3. If you require assistance or clarification on Ford Motor Company policies, please contact the Ford Customer Relationship Center.

In order to help you serve you better, please have the following information available when contacting a Customer Relationship Center:

- Vehicle Identification Number.
- Your telephone number (home and business).

- The name of the authorized dealer and city where located.
- The vehicle's current odometer reading.

In some states, you must directly notify Ford in writing before pursuing remedies under your state's warranty laws. Ford is also allowed a final repair attempt in some states.

In the United States, a warranty dispute must be submitted to the BBB AUTO LINE before taking action under the Magnuson-Moss Warranty Act, or to the extent allowed by state law, before pursuing replacement or repurchase remedies provided by certain state laws. This dispute handling procedure is not required prior to enforcing state created rights or other rights which are independent of the Magnuson-Moss Warranty Act or state replacement or repurchase laws.

## IN CALIFORNIA (U.S. ONLY)

California Civil Code Section 1793.2(d) requires that, if a manufacturer or its representative is unable to repair a motor vehicle to conform to the vehicle's applicable express warranty after a reasonable number of attempts, the manufacturer shall be required to either replace the vehicle with one substantially identical or repurchase the vehicle and reimburse the buyer in an amount equal to the actual price paid or payable by the consumer (less a reasonable allowance for consumer use). The consumer has the right to choose whether to receive a refund or replacement vehicle.

California Civil Code Section 1793.22(b) presumes that the manufacturer has had a reasonable number of attempts to conform the vehicle to its applicable express warranties if, within the first 18 months of ownership of a new vehicle or the first 18000 miles (29 000 km), whichever occurs first:

1. Two or more repair attempts are made on the same non-conformity likely to cause death or serious bodily injury OR

## Customer Assistance

---

2. Four or more repair attempts are made on the same nonconformity (a defect or condition that substantially impairs the use, value or safety of the vehicle) OR
3. The vehicle is out of service for repair of nonconformities for a total of more than 30 calendar days (not necessarily all at one time).

In the case of 1 or 2 above, the consumer must also notify the manufacturer of the need for the repair of the nonconformity at the following address:

Ford Motor Company  
16800 Executive Plaza Drive  
Mail Drop 3NE-B  
Dearborn, MI 48126

You are required to submit your warranty dispute to BBB AUTO LINE before asserting in court any rights or remedies conferred by California Civil Code Section 1793.22(b). You are also required to use BBB AUTO LINE before exercising rights or seeking remedies created by the Federal Magnuson-Moss

Warranty Act, 15 U.S.C. sec. 2301 et seq. If you choose to seek redress by pursuing rights and remedies not created by California Civil Code Section 1793.22(b) or the Magnuson-Moss Warranty Act, resort to BBB AUTO LINE is not required by those statutes.

### **THE BETTER BUSINESS BUREAU (BBB) AUTO LINE PROGRAM (U.S. ONLY)**

Your satisfaction is important to Ford Motor Company and to your dealer. If a warranty concern has not been resolved using the three-step procedure outlined earlier in this chapter in the Getting the Services you need section, you may be eligible to participate in the BBB AUTO LINE program.

The BBB AUTO LINE program consists of two parts – mediation and arbitration. During mediation, a representative of the BBB will contact both you and Ford Motor Company to explore options for settlement of the claim. If an agreement is not reached during mediation or you do not want to participate in mediation, and if your claim is eligible, you

may participate in the arbitration process. An arbitration hearing will be scheduled so that you can present your case in an informal setting before an impartial person. The arbitrator will consider the testimony provided and make a decision after the hearing.

Disputes submitted to the BBB AUTO LINE program are usually decided within forty days after you file your claim with the BBB. You are not bound by the decision, and may reject the decision and proceed to court where all findings of the BBB Auto Line dispute, and decision, are admissible in the court action. Should you choose to accept the BBB AUTO LINE decision, Ford is then bound by the decision, and must comply with the decision within 30 days of receipt of your acceptance letter.

**BBB AUTO LINE Application:** Using the information provided below, please call or write to request a program application. You will be asked for your name and address, general information about your new vehicle, information about your warranty concerns, and any steps you have already taken to try

# Customer Assistance

---

to resolve them. A Customer Claim Form will be mailed that will need to be completed, signed and returned to the BBB along with proof of ownership. Upon receipt, the BBB will review the claim for eligibility under the Program Summary Guidelines.

**You can get more information by calling BBB AUTO LINE at 1-800-955-5100, or writing to:**

**BBB AUTO LINE  
4200 Wilson Boulevard, Suite 800  
Arlington, Virginia 22203-1833**

BBB AUTO LINE applications can also be requested by calling the Ford Motor Company Customer Relationship Center at 1-800-392-3673.

**Note:** *Ford Motor Company reserves the right to change eligibility limitations, modify procedures, or to discontinue this process at any time without notice and without obligation.*

## **UTILIZING THE MEDIATION/ARBITRATION PROGRAM (CANADA ONLY)**

For vehicles delivered to authorized Canadian dealers. In those cases where you continue to feel that the efforts by Ford of Canada and the authorized dealer to resolve a factory-related vehicle service concern have been unsatisfactory, Ford of Canada participates in an impartial third party mediation/arbitration program administered by the Canadian Motor Vehicle Arbitration Plan (CAMVAP).

The CAMVAP program is a straight forward and relatively speedy alternative to resolve a disagreement when all other efforts to produce a settlement have failed. This procedure is without cost to you and is designed to eliminate the need for lengthy and expensive legal proceedings.

In the CAMVAP program, impartial third-party arbitrators conduct hearings at mutually convenient times and places in an informal environment. These impartial arbitrators review the positions of the parties, make decisions and, when appropriate, render awards to resolve disputes. CAMVAP decisions are fast, fair, and final as the arbitrator's award is binding on both you and Ford of Canada.

CAMVAP services are available in all Canadian territories and provinces. For more information, without charge or obligation, call your CAMVAP Provincial Administrator directly at 1-800-207-0685 or visit [www.camvap.ca](http://www.camvap.ca).

## **GETTING ASSISTANCE OUTSIDE THE U.S. AND CANADA**

Before exporting your vehicle to a foreign country, contact the appropriate foreign embassy or consulate. These officials can inform you of local vehicle registration regulations and where to find unleaded fuel.

## Customer Assistance

---

If you cannot find unleaded fuel or can only get fuel with an anti-knock index lower than is recommended for your vehicle, contact our Customer Relationship Center.

The use of leaded fuel in your vehicle without proper conversion may damage the effectiveness of your emission control system and may cause engine knocking or serious engine damage. Ford Motor Company or Ford of Canada is not responsible for any damage caused by use of improper fuel. Using leaded fuel may also result in difficulty importing your vehicle back into the United States.

If your vehicle must be serviced while you are traveling or living in Asia-Pacific Region, Sub-Saharan Africa, U.S. Virgin Islands, Central America, the Caribbean, and Israel, contact the nearest authorized dealer. If the authorized dealer cannot help you, contact:

FORD MOTOR COMPANY  
Customer Relationship Center  
1555 Fairlane Drive  
Fairlane Business Park #3  
Allen Park, Michigan 48101  
U.S.A.  
Telephone: (313) 594-4857  
Fax: (313) 390-0804  
Email: [expcac@ford.com](mailto:expcac@ford.com)

For customers in Guam, the Commonwealth of the Northern Mariana Islands (CNMI), America Samoa, and the U.S. Virgin Islands, please feel free to call our Toll-Free Number: (800) 841-FORD (3673).

If your vehicle must be serviced while you are traveling or living in Puerto Rico, contact the nearest authorized dealer. If the authorized dealer cannot help you, contact:

FORD MOTOR COMPANY  
Customer Relationship Center  
1555 Fairlane Drive  
Fairlane Business Park #3  
Allen Park, Michigan 48101  
U.S.A.  
Telephone: (800) 841-FORD (3673)  
FAX: (313) 390-0804  
Email: [prcac@ford.com](mailto:prcac@ford.com)  
[www.ford.com.pr](http://www.ford.com.pr)

If your vehicle must be serviced while you are traveling or living in the Middle East, contact the nearest authorized dealer. If the authorized dealer cannot help you, contact:

# Customer Assistance

---

FORD MOTOR COMPANY  
Customer Relationship Center  
1555 Fairlane Drive  
Fairlane Business Park #3  
Allen Park, Michigan 48101  
U.S.A.  
Telephone: +971 4 3326084  
Toll-Free Number of the Kingdom of Saudi  
Arabia: 800 8971409  
Local Telephone Number of Kuwait:  
24810575  
FAX: +971 4 3327299  
Email: [menacac@ford.com](mailto:menacac@ford.com)  
[www.me.ford.com](http://www.me.ford.com)

If you buy your vehicle in North America and then relocate to any of the above locations, register your vehicle identification number (VIN) and new address with Ford Motor Company Export Operations & Global Growth Initiatives by emailing [expcac@ford.com](mailto:expcac@ford.com).

If you are in another foreign country, contact the nearest authorized dealer. In the event your inquiry is unresolved, communicate your concern with the dealership's Sales Manager, Service Manager or Customer Relations Manager. If you require additional assistance or clarification, please contact the respective Customer Relationship Center as previously listed.

**Customers in the U.S. should call  
1-800-392-3673.**

## ORDERING ADDITIONAL OWNER'S LITERATURE

To order the publications in this portfolio, contact Helm, Incorporated at:

HELM, INCORPORATED  
47911 Halyard Drive  
Plymouth, Michigan 48170  
Attention: Customer Service

Or to order a free publication catalog, call toll free: 1-800-782-4356

Monday-Friday 8:00 a.m. - 6:00 p.m. EST

Helm, Incorporated can also be reached by their website:

[www.helminc.com](http://www.helminc.com)

(Items in this catalog may be purchased by credit card, check or money order.)

## Obtaining a French Owner's Manual

French Owner's Manual can be obtained from your authorized dealer or by contacting Helm, Incorporated using the contact information listed previously in this section.

## REPORTING SAFETY DEFECTS (U.S. ONLY)



E142557

## Customer Assistance

---

If you believe that your vehicle has a defect which could cause a crash or could cause injury or death, you should immediately inform the National Highway Traffic Safety Administration (NHTSA) in addition to notifying Ford Motor Company.

If NHTSA receives similar complaints, it may open an investigation, and if it finds that a safety defect exists in a group of vehicles, it may order a recall and remedy campaign. However, NHTSA cannot become involved in individual problems between you, your dealer, or Ford Motor Company.

To contact NHTSA, you may call the Vehicle Safety Hotline toll-free at 1-888-327-4236 (TTY: 1-800-424-9153); go to <http://www.safercar.gov>; or write to:

Administrator

1200 New Jersey Avenue, Southeast  
Washington, D.C. 20590

You can also obtain other information about motor vehicle safety from <http://www.safercar.gov>.

### **REPORTING SAFETY DEFECTS (CANADA ONLY)**

If you believe that your vehicle has a defect which could cause a crash or could cause injury or death, you should immediately inform Transport Canada.

Transport Canada Contact Information	
Website	<a href="http://www.tc.gc.ca/eng/roadsafety/menu.htm">http://www.tc.gc.ca/eng/roadsafety/menu.htm</a>
Phone	1-800-333-0510

# Fuses

---

## FUSE SPECIFICATION CHART

### Power Distribution Box

#### WARNINGS



Always disconnect the battery before servicing high-current fuses.

#### WARNINGS



To reduce risk of electrical shock, always replace the cover to the power distribution box before reconnecting the battery or refilling fluid reservoirs.

---

The power distribution box is in the engine compartment. It has high-current fuses that protect your vehicle's main electrical systems from overloads.

If you disconnect and reconnect the battery, you will need to reset some features. See **Changing the 12V Battery** (page 295).

# Fuses

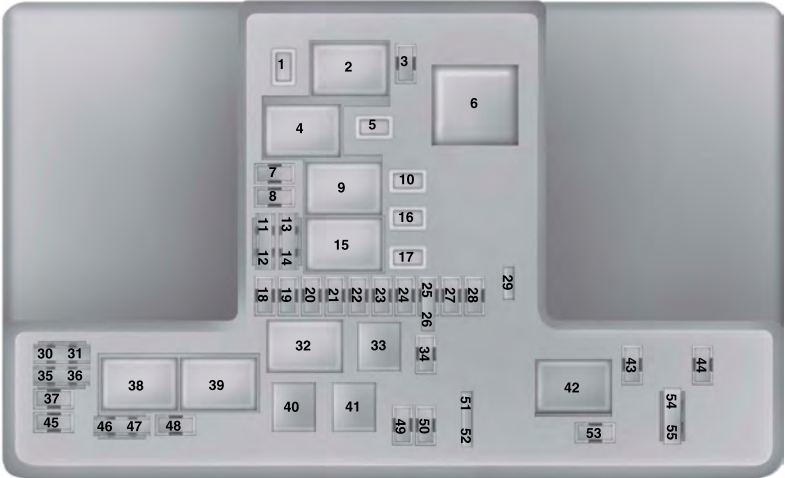

E144783

## Fuses

Fuse or relay number	Fuse amp rating	Protected components
1	25A <sup>3</sup>	Wiper Motor 2
2	–	Not used
3	15A <sup>1</sup>	Autowipers
4	–	Blower motor relay
5	20A <sup>3</sup>	Power point 3 - back of console
6	–	Not used
7	20A <sup>1</sup>	Powertrain control module - vehicle power 1
8	20A <sup>1</sup>	Powertrain control module - vehicle power 2
9	–	Powertrain control module relay
10	20A <sup>3</sup>	Power point 1 - driver front
11	15A <sup>2</sup>	Powertrain control module - vehicle power 4
12	15A <sup>2</sup>	Powertrain control module - vehicle power 3

# Fuses

Fuse or relay number	Fuse amp rating	Protected components
13	10A <sup>2</sup>	Powertrain control module vehicle power 5
14	10A <sup>2</sup>	Powertrain control module vehicle power 6
15	–	Run/start relay
16	20A <sup>3</sup>	Power point 2 - console
17	20A <sup>3</sup>	PHEV transmission oil pump
18	10A <sup>1</sup>	Powertrain and hybrid powertrain control module - keep alive power
19	10A <sup>1</sup>	Run/start electronic power assist steering
20	10A <sup>1</sup>	Run/start lighting
21	15A <sup>1</sup>	Run/start hybrid powertrain control module
22	–	Not used
23	15A <sup>1</sup>	Run/start: blind spot information system, rear view camera, adaptive cruise control, heads-up display, shifter
24	10A <sup>1</sup>	Run/Start 7 or PHEV transmission oil run/start

## Fuses

Fuse or relay number	Fuse amp rating	Protected components
25	10A <sup>2</sup>	Run/start anti-lock brake system
26	10A <sup>2</sup>	Run/start powertrain control module
27	15A <sup>1</sup>	PHEV fuel door solenoid
28	–	Not used
29	15A <sup>1</sup>	Hybrid content vehicle power 5
30	–	Not used
31	–	Not used
32	–	Not used
33	–	Not used
34	10A <sup>2</sup>	Electronic steering column lock
35	15A <sup>2</sup>	PHEV charger fan
36	15A <sup>2</sup>	HEV BEC Fan
37	–	Not used

# Fuses

Fuse or relay number	Fuse amp rating	Protected components
38	–	Vacuum pump #1 relay
39	–	Vacuum pump #2 relay
40	–	Fuel pump relay
41	–	Horn relay
42	–	Not used
43	–	Not used
44	5A <sup>1</sup>	Heated washer nozzle
45	5A <sup>1</sup>	Vacuum pump monitor
46	10A <sup>2</sup>	Alt Sen or charge port LT
47	10A <sup>2</sup>	Brake on/off switch
48	20A <sup>1</sup>	Horn
49	5A <sup>1</sup>	MAF
50	–	Not used

# Fuses

Fuse or relay number	Fuse amp rating	Protected components
51	15A <sup>2</sup>	Hybrid content vehicle power 1
52	15A <sup>2</sup>	Hybrid content vehicle power 2
53	10A <sup>1</sup>	Power seats
54	10A <sup>2</sup>	Hybrid content vehicle power 4
55	10A <sup>2</sup>	Hybrid content vehicle power 3

<sup>1</sup> Micro fuse

<sup>2</sup> Dual micro fuse

<sup>3</sup> M-type fuse

<sup>4</sup> J-type fuse

# Fuses

## Power Distribution Box - Bottom

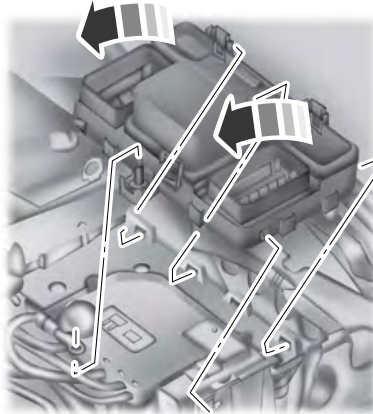

E145983

There are fuses located on the bottom of the fuse box. To access the bottom of the fuse box, do the following:

1. Release the two latches, located on both sides of the fuse box.
2. Raise the inboard side of the fuse box from the cradle.
3. Move the fuse box toward the center of the engine compartment.
4. Pivot the outboard side of the fuse box to access the bottom side.

# Fuses

---

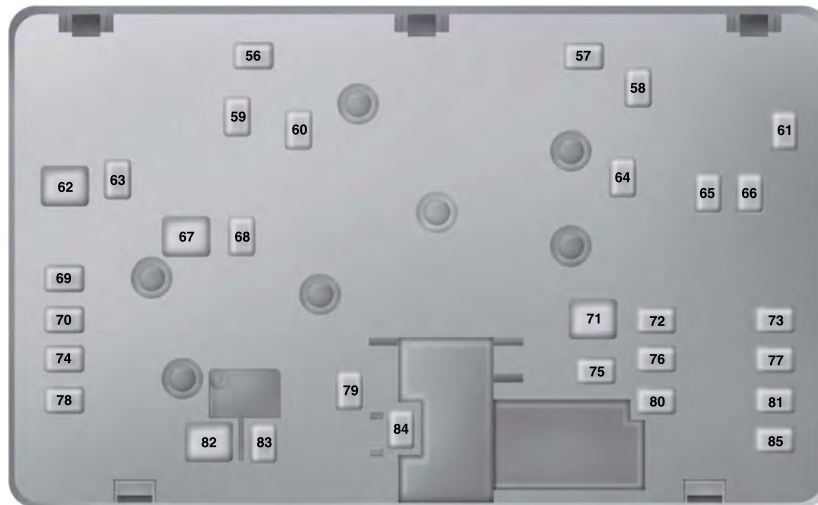

E144949

# Fuses

Fuse or relay number	Fuse amp rating	Protected components
56	30A <sup>1</sup>	Fuel pump
57	-	Not used
58	-	Not used
59	40A <sup>1</sup>	Vacuum pump relay
60	40A <sup>1</sup>	PWM fan
61	40A <sup>1</sup>	Left side windshield defroster
62	50A <sup>2</sup>	Body control module 1
63	-	Not used
64	40A <sup>1</sup>	PHEV charger
65	20A <sup>1</sup>	Front heated seat
66	40A <sup>1</sup>	Right side windshield defroster
67	50A <sup>2</sup>	Body control module 2

## Fuses

Fuse or relay number	Fuse amp rating	Protected components
68	40A <sup>1</sup>	Heated rear window
69	30A <sup>1</sup>	Anti-lock brake system valves
70	30A <sup>1</sup>	Passenger seat
71	-	Not used
72	30A <sup>1</sup>	Panoramic roof #1
73	20A <sup>1</sup>	Rear climate controlled seats
74	30A <sup>1</sup>	Driver seat module
75	-	Not used
76	20A <sup>1</sup>	iShifter Transmission oil pump
77	30A <sup>1</sup>	Front climate controlled seats
78	-	Not used
79	40A <sup>1</sup>	Blower motor

# Fuses

Fuse or relay number	Fuse amp rating	Protected components
80	30A <sup>1</sup>	Power decklid
81	40A <sup>1</sup>	Inverter
82	–	Not used
83	25A <sup>1</sup>	Wiper motor #1
84	-	Not used
85	30A <sup>1</sup>	Panoramic roof #2

<sup>1</sup> M-type fuse

<sup>2</sup> J-type fuse

## Passenger Compartment Fuse Panel

The fuse panel is under the instrument panel to the left of the steering column.

# Fuses

---



E145984

# Fuses

Fuse or relay number	Fuse amp rating	Protected components
1	10A <sup>1</sup>	Lighting (ambient, glove box, vanity, dome, trunk)
2	7.5A <sup>1</sup>	Memory seats, Lumbar, Power mirror
3	20A <sup>1</sup>	Driver door unlock
4	5A <sup>1</sup>	Not used (spare)
5	20A <sup>1</sup>	Subwoofer amplifier, THX amplifier
6	10A <sup>2</sup>	Heated seat relay coil
7	10A <sup>2</sup>	Not used (spare)
8	10A <sup>2</sup>	Not used (spare)
9	10A <sup>2</sup>	Not used (spare)
10	5A <sup>2</sup>	Power trunk logic eypad Keypad
11	5A <sup>2</sup>	Not used (spare)

## Fuses

Fuse or relay number	Fuse amp rating	Protected components
12	7.5A <sup>2</sup>	Climate control Gear shift
13	7.5A <sup>2</sup>	Steering wheel column Instrument cluster Datalink logic
14	10A <sup>2</sup>	Battery electronic control module DCDC
15	10A <sup>2</sup>	Datalink/Gateway module
16	15A <sup>1</sup>	Decklid/Liftglass release Child lock
17	5A <sup>2</sup>	Not used (spare)
18	5A <sup>2</sup>	Ignition Push button start/stop
19	5A <sup>2</sup>	Passenger airbag disabled indicator, Transmission range
20	5A <sup>2</sup>	Adaptive headlamps
21	5A <sup>2</sup>	Humidity and in-car temperature Blind spot Rear video camera

# Fuses

Fuse or relay number	Fuse amp rating	Protected components
		Adaptive cruise control
22	5A <sup>2</sup>	Occupant classification sensor
23	10A <sup>1</sup>	Delayed accessory (power inverter, moonroof, all smart window, driver window switch pack)
24	30A <sup>1</sup>	Central lock/unlock
25	20A <sup>1</sup>	Driver door (window, mirror)
26	30A <sup>1</sup>	Front passenger door (window, mirror)
27	30A <sup>1</sup>	Moonroof
28	20A <sup>1</sup>	THX amplifier
29	30A <sup>1</sup>	Rear driver side door (window)
30	30A <sup>1</sup>	Rear passenger side door (window)
31	–	Not used (spare)
32	10A <sup>1</sup>	GPS Voice control

# Fuses

Fuse or relay number	Fuse amp rating	Protected components
		Display Adaptive cruise control Radio frequency receiver
33	20A <sup>1</sup>	Radio
34	30A <sup>1</sup>	Run/start (fuse #19, 20, 21, 22, 35, 36, 37, circuit breaker)
35	5A <sup>1</sup>	Restraints control module
36	15A <sup>1</sup>	Auto-dimming rear view mirror Auto high beam Heated seat module All-wheel drive CCD Lane keeping system
37	15A <sup>1</sup>	Not used (spare)
38	30A	Rear window shade

<sup>1</sup>Micro fuse

<sup>2</sup>Dual micro fuse

## CHANGING A FUSE

### Fuses

#### WARNING

 You must replace a failed fuse with one that has the specified amperage rating. If you use a fuse with a higher amperage rating, you may cause severe wire damage and may start a fire.

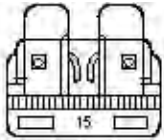

E142430

A fuse may fail if electrical components in the vehicle are not properly working. A broken wire inside the fuse indicates a failed fuse. Check the appropriate fuses before replacing any electrical components.

# Maintenance

---

## GENERAL INFORMATION

Have your vehicle serviced regularly to help maintain its roadworthiness and resale value. There is a large network of Ford authorized dealers that are there to help you with their professional servicing expertise. We believe that their specially trained technicians are best qualified to service your vehicle properly and expertly. They are supported by a wide range of highly specialized tools developed specifically for servicing your vehicle.

To help you service your vehicle, we provide scheduled maintenance information which makes tracking routine service easy. See **Scheduled Maintenance** (page 468).

If your vehicle requires professional service, your authorized dealer can provide the necessary parts and service. Check your warranty information to find out which parts and services are covered.

Use only recommended fuels, lubricants, fluids and service parts conforming to specifications. Motorcraft® parts are designed and built to provide the best performance in your vehicle.

## Precautions

- Do not work on a hot engine.
- Make sure that nothing gets caught in moving parts.
- Do not work on a vehicle with the engine running in an enclosed space, unless you are sure you have enough ventilation.
- Keep all open flames and other burning material (such as cigarettes) away from the battery and all fuel related parts.

## Working with the Engine Off

1. Set the parking brake and shift to **P** (Park).
2. Turn off the engine and remove the key (if equipped).
3. Block the wheels.

## Working with the Engine On

### WARNING



To reduce the risk of vehicle damage and/or personal burn injuries, do not start your engine with the air cleaner removed and do not remove it while the engine is running.

1. Set the parking brake and shift to **P** (Park).
2. Block the wheels

# Maintenance

## OPENING AND CLOSING THE HOOD



E142457

1. To open the hood, go inside the vehicle and pull the hood release handle located under the left-hand side of the instrument panel.

2. Go to the front of the vehicle and find the secondary release lever, which is located under the front of the hood, near the Lincoln badge.
3. Release the hood latch by pushing the secondary release lever to your left, toward the passenger side of the vehicle.
4. Raise the hood. A gas strut will support the hood.
5. To close the hood, lower the hood and apply closing force to the hood as it drops the last 8 to 11 inches (20 to 30 centimeters).

**Note:** Make sure that the hood is closed fully before operating your vehicle. A warning indicator will appear in the information display if not closed properly.

## UNDER HOOD OVERVIEW

### WARNING



The inverter system controller contains various high-voltage components that can cause serious bodily harm or death. The inverter system controller is not serviceable and should never be touched, probed, or tampered with.

**Note:** Do not attempt to service any of the high-voltage components or wiring. For easier identification, the high-voltage wiring insulation is color coated orange.

# Maintenance

---

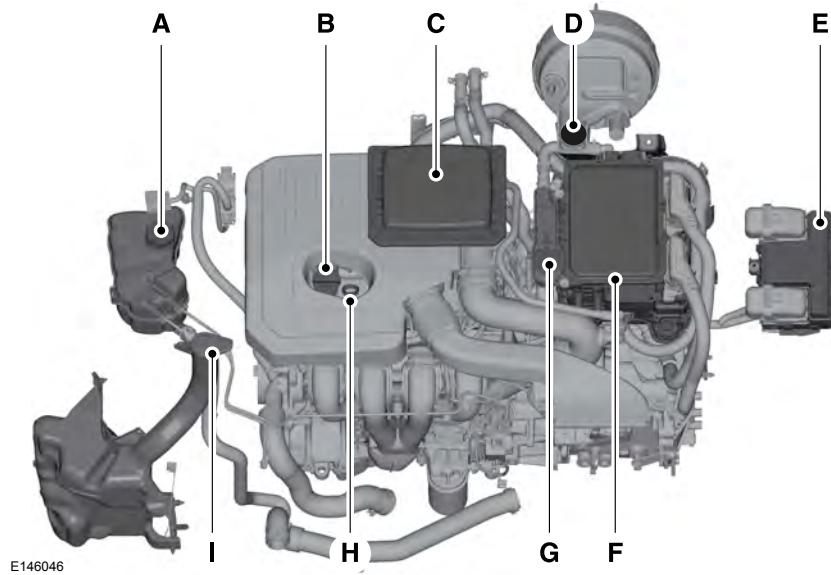

- A Engine coolant reservoir cap
- B Engine oil filler cap
- C Engine air cleaner cover

# Maintenance

- D Brake fluid reservoir cap
- E Power distribution box
- F Inverter system controller
- G Inverter system controller coolant reservoir cap
- H Engine oil dipstick
- I Windshield washer fluid reservoir cap

## ENGINE OIL DIPSTICK

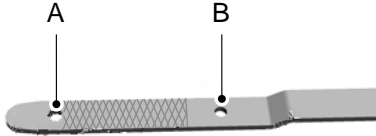

E169062

- A MIN
- B MAX

## ENGINE OIL CHECK

**Note:** Check the level before starting the engine.

**Note:** Make sure that the level is between the MIN and the MAX marks.

1. Make sure that your vehicle is on level ground.
2. Turn the engine off and wait 10 minutes for the oil to drain into the oil pan.
3. Remove the dipstick and wipe it with a clean, lint-free cloth. Replace the dipstick and remove it again to check the oil level.

If the level is at the MIN mark, add oil immediately.

## Adding Engine Oil

**Note:** Do not remove the filler cap when the engine is running.

**Note:** Do not add oil further than the MAX mark. Oil levels above the MAX mark may cause engine damage.



E142732

# Maintenance

---

Only use oils certified for gasoline engines by the American Petroleum Institute (API). An oil with this trademark symbol conforms to the current engine and emission system protection standards and fuel economy requirements of the International Lubricants Specification Advisory Council (ILSAC), comprised of U.S. and Japanese automobile manufacturers.

1. Remove the filler cap.
2. Add engine oil that meets the Ford specifications. See **Capacities and Specifications** (page 346).
3. Replace the filler cap. Turn it until you feel a strong resistance.

## ENGINE COOLANT CHECK

### Engine Coolant and Inverter System Controller Coolant

Your vehicle is equipped with two separate cooling systems. One is for cooling the engine and one is for cooling the inverter system controller that is specific to the hybrid operating system. The two systems operate similarly, with the inverter system controller cooling system generally operating at a lower temperature and pressure.

### Checking the Engine Coolant

When the engine is cold, check the concentration and level of the engine coolant at the intervals listed in the **Scheduled Maintenance** (page 468).

**Note:** Make sure that the level is between the MIN and MAX marks on the engine coolant reservoir.

**Note:** Coolant expands when it is hot. The level may extend beyond the MAX mark.

**Note:** If the level is at the MIN mark, below the MIN mark, or empty, add prediluted coolant immediately. See **Adding Engine Coolant** in this chapter.

The coolant concentration should be maintained within 48% to 50%, which equates to a freeze point between -30°F (-34°C) and -34°F (-37°C).

**Note:** For best results, coolant concentration should be tested with a refractometer such as Robinair Coolant and Battery Refractometer 75240. We do not recommend the use of hydrometers or coolant test strips for measuring coolant concentrations.

**Note:** Automotive fluids are not interchangeable. Do not use engine coolant or antifreeze or windshield washer fluid outside of its specified function and vehicle location.

# Maintenance

## Checking the Inverter System Controller Coolant

When the engine is cold, check the concentration and level of the inverter system controller coolant at the intervals listed in the scheduled maintenance information. See **Scheduled Maintenance** (page 468).

**Note:** Make sure that the level is between the MIN and MAX marks on the inverter system controller coolant reservoir.

**Note:** Coolant expands when it is hot. The level may extend beyond the MAX mark.

**Note:** If the level is at the MIN mark, below the MIN mark, or empty, add prediluted coolant immediately. See **Adding Inverter System Controller Coolant** in this chapter.

The coolant concentration should be maintained within 48% to 50%, which equates to a freeze point between -30°F (-34°C) and -34°F (-37°C).

**Note:** For best results, coolant concentration should be tested with a refractometer such as Robinair Coolant and Battery Refractometer 75240. We do not recommend the use of hydrometers or coolant test strips for measuring coolant concentrations.

**Note:** Automotive fluids are not interchangeable. Do not use engine coolant or antifreeze or windshield washer fluid outside of its specified function and vehicle location.

## Adding Coolant

### WARNINGS



Do not add engine coolant when the engine is hot. Steam and scalding liquids released from a hot cooling system can burn you badly. Also, you can be burned if you spill coolant on hot engine parts.



Do not put engine coolant in the windshield washer fluid container. If sprayed on the windshield, engine coolant could make it difficult to see through the windshield.

### WARNINGS



To reduce the risk of personal injury, make sure the engine is cool before unscrewing the coolant pressure relief cap. The cooling system is under pressure; steam and hot liquid can come out forcefully when the cap is loosened slightly.



Do not add coolant further than the MAX mark.

**Note:** Do not use stop leak pellets, cooling system sealants, or additives as they can cause damage to the cooling or heating systems. This damage would not be covered under your vehicle's warranty.

**Note:** During normal vehicle operation, the coolant may change color from orange to pink or light red. As long as the coolant is clear and uncontaminated, this color change does not indicate the coolant has degraded nor does it require the coolant to be drained, the system to be flushed, or the coolant to be replaced.

# Maintenance

---

**Note:** *It is very important to use prediluted coolant meeting the Ford specification in order to avoid plugging the small coolant passageways. Use of concentrated coolant and water may cause coolant passageway plugging and void the warranty. See **Capacities and Specifications** (page 346).*

- Do not mix different colors or types of coolant in your vehicle. Make sure the correct coolant is used. Mixing of coolants may harm your cooling system. The use of an improper coolant may harm the engine, inverter system controller, and cooling system components and may void the warranty.
- In case of emergency, a large amount of water without engine coolant may be added to the engine cooling system in order to reach a vehicle service location. In this instance, the engine cooling system must be drained, chemically cleaned with Motorcraft Premium Cooling System Flush, and refilled with prediluted engine coolant as soon as possible. Water alone (without engine coolant) can cause engine damage from corrosion, overheating, or freezing. **DO NOT** use this method for the inverter system controller cooling system. The inverter system controller cooling system operates close to ambient temperature, and is susceptible to freezing in any subfreezing environment in the absence of coolant.

- Do not use alcohol, methanol, brine or any engine coolants mixed with alcohol or methanol antifreeze (coolant). Alcohol and other liquids can cause engine damage from overheating or freezing.
- Do not add extra inhibitors or additives to the coolant. These can be harmful and compromise the corrosion protection of the engine coolant.

## Adding Engine Coolant

1. Unscrew the engine coolant reservoir cap slowly. Any pressure will escape as you unscrew the cap.
2. Use a funnel to add prediluted engine coolant to the engine coolant reservoir. Make sure that the level is between the MIN and MAX marks on the engine coolant reservoir. Use prediluted engine coolant meeting the Ford specification. See **Capacities and Specifications** (page 346).
3. Close the engine coolant reservoir cap.

# Maintenance

---

Whenever you add coolant, check the coolant level in the engine coolant reservoir the next few times you drive the vehicle. If necessary, add enough prediluted engine coolant to bring the engine coolant level to the proper level.

## Adding Inverter System Controller Coolant

1. Open the inverter system controller coolant reservoir cap.
2. Use a funnel to add prediluted coolant to the inverter system controller coolant reservoir. Make sure that the level is between the MIN and MAX marks on the inverter system controller coolant reservoir. Use prediluted coolant meeting the Ford specification. See **Capacities and Specifications** (page 346).
3. Close the inverter system controller coolant reservoir cap.

Whenever you add coolant, check the coolant level in the inverter system controller coolant reservoir the next few times you drive the vehicle. If necessary, add enough prediluted coolant to bring the inverter system controller coolant level to the proper level.

## Recycled Engine Coolant

Ford Motor Company does not recommend the use of recycled engine coolant since a Ford-approved recycling process is not yet available.

Used engine coolant should be disposed of in an appropriate manner. Follow your community's regulations and standards for recycling and disposing of automotive fluids.

## Severe Climates

If you drive in extremely cold climates:

- It may be necessary to have an authorized Ford dealer increase the coolant concentration above 50%.
- A coolant concentration of 60% will provide improved freeze point protection. Engine coolant concentrations above 60% will decrease the overheat protection characteristics of the engine coolant and may cause engine damage.

If you drive in extremely hot climates:

- It may be necessary to have an authorized Ford dealer decrease the coolant concentration to 40%.
- A coolant concentration of 40% will provide improved overheat protection. Engine coolant concentrations below 40% will decrease the corrosion/freeze protection characteristics of the engine coolant and may cause engine damage.

Vehicles driven year-round in non-extreme climates should use prediluted coolant meeting the Ford specification for optimum cooling system and engine protection.

# Maintenance

## What You Should Know About Fail-Safe Cooling

If the engine coolant supply is depleted, this feature allows the vehicle to be driven temporarily before incremental component damage is incurred. The “fail-safe” distance depends on ambient temperatures, vehicle load and terrain.

### How Fail-Safe Cooling Works

If the engine begins to overheat, the engine coolant temperature gauge will move to the red (hot) area and:



The coolant temperature warning light will illuminate.



The service engine soon indicator will illuminate.

If the engine reaches a preset over-temperature condition, the engine will automatically switch to alternating cylinder operation. Each disabled cylinder acts as an air pump and cools the engine.

When this occurs the vehicle will still operate. However:

- The engine power will be limited.
- The air conditioning system will be disabled.

Continued operation will increase the engine temperature and the engine will completely shut down, causing steering and braking effort to increase.

Once the engine temperature cools, the engine can be re-started. Take your vehicle to an authorized dealer as soon as possible to minimize engine damage.

### When Fail-Safe Mode Is Activated

#### WARNINGS



Fail-safe mode is for use during emergencies only. Operate the vehicle in fail-safe mode only as long as necessary to bring the vehicle to rest in a safe location and seek immediate repairs. When in fail-safe mode, the vehicle will have limited power, will not be able to maintain high-speed

#### WARNINGS

operation, and may completely shut down without warning, potentially losing engine power, power steering assist, and power brake assist, which may increase the possibility of a crash resulting in serious injury.



Never remove the coolant reservoir cap while the engine is running or hot.

**Note:** *Driving the vehicle without repairing the engine problem increases the chance of engine damage. Take your vehicle to an authorized dealer as soon as possible.*

You have limited engine power when in the fail-safe mode, so drive the vehicle with caution. The vehicle will not be able to maintain high-speed operation and the engine will run rough. Remember that the engine is capable of completely shutting down automatically to prevent engine damage, therefore:

1. Pull off the road as soon as safely possible and turn off the engine.
2. Arrange for the vehicle to be taken to an authorized dealer.

# Maintenance

3. If this is not possible, wait a short period for the engine to cool.
4. Check the coolant level and replenish if low.
5. Re-start the engine and take your vehicle to an authorized dealer.

## AUTOMATIC TRANSMISSION FLUID CHECK

**Note:** *Transmission fluid should be checked by an authorized dealer. If required, fluid should be added by an authorized dealer.*

The automatic transmission does not have a transmission fluid dipstick.

Have an authorized dealer check and change the transmission fluid at the correct service interval. See **Scheduled Maintenance** (page 468). Your transmission does not consume fluid. However, the fluid level should be checked if the transmission is not working properly, (i.e., if the transmission slips or shifts slowly) or if you notice some sign of fluid leakage.

Do not use supplemental transmission fluid additives, treatments or cleaning agents. The use of these materials may affect transmission operation and result in damage to internal transmission components.

## BRAKE FLUID CHECK

Fluid levels between the MIN and MAX lines are within the normal operating range; there is no need to add fluid. If the fluid levels are outside of the normal operating range, the performance of the system could be compromised; seek service from your authorized dealer immediately.

## POWER STEERING FLUID CHECK

Your vehicle is equipped with an electric power steering (EPS) system. There is no fluid reservoir to check or fill.

## WASHER FLUID CHECK

### WARNING



If you operate your vehicle in temperatures below 40°F (5°C), use washer fluid with antifreeze protection. Failure to use washer fluid with antifreeze protection in cold weather could result in impaired windshield vision and increase the risk of injury or accident.

**Note:** *The front and rear washer systems are supplied from the same reservoir.*

Add fluid to fill the reservoir if the level is low. Only use a washer fluid that meets Ford specifications. See **Capacities and Specifications** (page 346).

State or local regulations on volatile organic compounds may restrict the use of methanol, a common windshield washer antifreeze additive. Washer fluids containing non-methanol antifreeze agents should be used only if they provide cold weather protection without damaging the vehicle's paint finish, wiper blades or washer system.

# Maintenance

## FUEL FILTER

Your vehicle is equipped with a lifetime fuel filter that is integrated with the fuel tank. Regular maintenance or replacement is not needed.

## CHANGING THE 12V BATTERY

### WARNINGS



Batteries normally produce explosive gases which can cause personal injury. Therefore, do not allow flames, sparks or lighted substances to come near the battery. When working near the battery, always shield your face and protect your eyes. Always provide proper ventilation.



When lifting a plastic-cased battery, excessive pressure on the end walls could cause acid to flow through the vent caps, resulting in personal injury and damage to the vehicle or battery. Lift the battery with a battery carrier or with your hands on opposite corners.

### WARNINGS



Keep batteries out of reach of children. Batteries contain sulfuric acid. Avoid contact with skin, eyes or clothing. Shield your eyes when working near the battery to protect against possible splashing of acid solution. In case of acid contact with skin or eyes, flush immediately with water for a minimum of 15 minutes and get prompt medical attention. If acid is swallowed, call a physician immediately.

Your vehicle is equipped with a Motorcraft® maintenance-free battery which normally does not require additional water during its life of service.

**Note:** *If your battery has a cover or shield, make sure it is reinstalled after the battery has been cleaned or replaced.*

**Note:** *See an authorized dealer for low voltage battery access, testing, or replacement.*

When a low voltage battery replacement is necessary, see an authorized dealer to replace the low voltage battery with a Ford recommended replacement low voltage battery that matches the electrical requirements of the vehicle

To ensure proper operation of the battery management system (BMS), do not allow a technician to connect any electrical device ground connection directly to the low voltage battery negative post. A connection at the low voltage battery negative post can cause inaccurate measurements of the battery condition and potential incorrect system operation.

**Note:** *If a person adds electrical or electronic accessories or components to the vehicle, the accessories or components may adversely affect the low voltage battery performance and durability and may also affect the performance of other electrical systems in the vehicle.*

For longer, trouble-free operation, keep the top of the battery clean and dry. Also, make certain the battery cables are always tightly fastened to the battery terminals.

# Maintenance

---

If you see any corrosion on the battery or terminals, remove the cables from the terminals and clean with a wire brush. You can neutralize the acid with a solution of baking soda and water.

When a battery replacement is required, the battery should only be replaced with a Ford recommended replacement battery that matches the electrical requirements of the vehicle.

Because your vehicle's engine is electronically-controlled by a computer, some engine control settings are maintained by power from the low voltage battery. Some engine computer settings, like the idle trim and fuel trim strategy, optimize the driveability and performance of the engine. Some other computer settings, like the clock and radio station presets, are also maintained in memory by power from the low voltage battery. When a technician disconnects and connects the low voltage battery, these settings are erased.

**Note:** *Until you switch the ignition to the on position, you will receive a message in your information display stating that your vehicle is not in park.*

Complete the following procedure in order to restore the settings:

1. With the vehicle at a complete stop, set the parking brake.
2. Shift the transmission into P.
3. Turn off all accessories.
4. Step on the brake pedal and start the vehicle.
5. Run the engine until it reaches normal operating temperature. While the engine is warming up, complete the following: Reset the clock. See **Audio System** (page 355). Reset the power windows bounce-back feature. See **Windows and Mirrors** (page 93). Reset the radio station presets. See **Audio System** (page 355).
6. Allow the engine to idle for at least one minute. If the engine turns off, step on the accelerator to start the engine.

7. While the engine is running, step on the brake pedal and shift the transmission to N.
8. Allow the engine to run for at least one minute by pressing on the accelerator pedal.
9. Drive your vehicle at least 10 miles (16 kilometers) to completely relearn the idle and fuel trim strategy.

**Note:** *Certain features may not operate if the Battery Monitor System is not reset with a scan tool following a jump start or battery replacement. Normal electrical accessory operation should resume after your vehicle is left undisturbed for 8 hours.*

**Note:** *If you do not allow the engine to relearn the idle and fuel trim strategy, the idle quality of your vehicle may be adversely affected until the engine computer eventually relearns the idle trim and fuel trim strategy.*

# Maintenance

**Note:** Always dispose of automotive batteries in a responsible manner. Follow your local authorized standards for disposal. Call your local authorized recycling center to find out more about recycling automotive batteries.

**Note:** It is recommended that the negative battery cable terminal be disconnected from the battery if you plan to store your vehicle for an extended period of time.

## CHECKING THE WIPER BLADES



E142463

Run the tip of your fingers over the edge of the blade to check for roughness.

Clean the wiper blades with washer fluid or water applied with a soft sponge or cloth.

## CHANGING THE WIPER BLADES

The wiper arms can be manually moved when the ignition is off. This allows for ease of blade replacement and cleaning under the blades.

1. Pull the wiper blade and arm away from the glass.

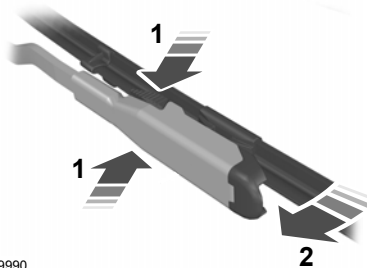

E129990

2. Press the locking buttons together.
3. Rotate and remove the wiper blade.
4. Install in the reverse order.

**Note:** Make sure that the wiper blade locks into place. Lower the wiper arm and blade back to the windshield. The wiper arms will automatically return to their normal position when the ignition is turned on.

Replace wiper blades at least once per year for optimum performance.

Poor wiper quality can be improved by cleaning the wiper blades and the windshield.

## ADJUSTING THE HEADLAMPS

### Vertical Aim Adjustment

The headlamps on your vehicle are properly aimed at the assembly plant. If your vehicle has been in an accident, the alignment of your headlamps should be checked by your authorized dealer.

# Maintenance

## Headlamp Aiming Target

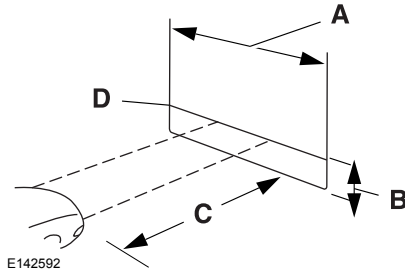

E142592

- A 8 feet (2.4 meters)
- B Center height of lamp to ground
- C 25 feet (7.6 meters)
- D Horizontal reference line

## Vertical Aim Adjustment Procedure

1. Park the vehicle directly in front of a wall or screen on a level surface, approximately 25 feet (7.6 meters) away.

2. Measure the height of the headlamp bulb center from the ground and mark an 8 foot (2.4 meter) horizontal reference line on the vertical wall or screen at this height.

**Note:** To see a clearer light pattern for adjusting, you may want to block the light from one headlamp while adjusting the other.

3. Turn on the low beam headlamps to illuminate the wall or screen and open the hood.



E142465

4. On the wall or screen you will observe a flat zone of high intensity light located at the top of the right hand portion of the beam pattern. If the top edge of the high intensity light zone is not at the horizontal reference line, the headlamp will need to be adjusted.

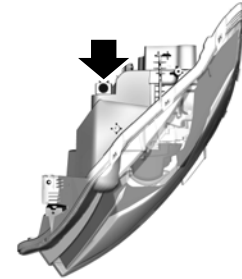

E150095

5. Locate the vertical adjuster on each headlamp. Using a Phillips #2 screwdriver, turn the adjuster either clockwise or counterclockwise in order to adjust the vertical aim of the headlamp. The horizontal edge of the brighter light should touch the horizontal reference line.
6. Close the hood and turn off the lamps.

# Maintenance

## Horizontal Aim Adjustment

Horizontal aim is not required for this vehicle and is not adjustable.

## CHANGING A BULB

### Lamp Assembly Condensation

Exterior lamps are vented to accommodate normal changes in pressure. Condensation can be a natural by-product of this design. When moist air enters the lamp assembly through the vents, there is a possibility that condensation can occur when the temperature is cold. When normal

condensation occurs, a thin film of mist can form on the interior of the lens. The thin mist eventually clears and exits through the vents during normal operation. Clearing time may take as long as 48 hours under dry weather conditions.

Examples of acceptable condensation are:

- Presence of thin mist (no streaks, drip marks or droplets).
- Fine mist covers less than 50% of the lens.

Examples of unacceptable moisture (usually caused by a lamp water leak) are:

- Water puddle inside the lamp.
- Large water droplets, drip marks or streaks present on the interior of the lens.

Take your vehicle to a dealer for service if any of the above conditions of unacceptable moisture are present.

## Replacing Bulbs

For replacing bulbs, see your authorized dealer.

## BULB SPECIFICATION CHART

Replacement bulbs are specified in the chart below. Headlamp bulbs must be marked with an authorized "D.O.T." for North America to make sure they have the proper lamp performance, light brightness, light pattern, and safe visibility. The correct bulbs will not damage the lamp assembly or void the lamp assembly warranty and will provide quality bulb illumination time.

Function	Trade name
Headlamp high beam	LED
Headlamp low beam	LED
Side marker lamp - front	LED

# Maintenance

Function	Trade name
Park lamp - front	LED
Turn lamp - front	LED
Tail and brake lamp - high series	LED
Tail and brake lamp - low series	LED
Reverse lamp	LED
Turn lamp - rear - high series	LED
Turn lamp - rear - low series	LED
Side marker lamp - rear	LED
License plate lamp	LED
Trunk lamp	LED
High-mount brake lamp	LED
Side repeater lamp	LED
Glove compartment lamp	LED
Interior lamp	LED

To replace any bulb, see your authorized dealer.

# Maintenance

## CHANGING THE ENGINE AIR FILTER

### WARNING



To reduce the risk of vehicle damage and/or personal burn injuries do not start your engine with the air cleaner removed and do not remove it while the engine is running.

When changing the air filter element, use only the air filter element listed. See **Capacities and Specifications** (page 346).

Change the air filter element at the proper interval. See **Scheduled Maintenance** (page 468).

**Note:** Failure to use the correct air filter element may result in severe engine damage. The customer warranty may be void for any damage to the engine if the correct air filter element is not used.

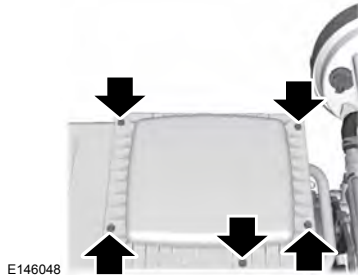

1. Loosen the 5 bolts on the air cleaner cover.
2. Remove the air cleaner cover.
3. Remove the engine air filter element from the engine air cleaner assembly.
4. Wipe any dirt or debris from the air filter housing and cover to make sure no dirt gets in the engine and to make sure you have a good seal.

5. Install the new engine air filter element to the engine air cleaner assembly.
6. Install the air cleaner cover.
7. Tighten the 5 bolts to the air cleaner cover.

# Vehicle Care

---

## GENERAL INFORMATION

Your Ford or Lincoln authorized dealer has many quality products available to clean your vehicle and protect its finishes.

## CLEANING PRODUCTS

For best results, use the following products or products of equivalent quality:

- Motorcraft Bug and Tar Remover (ZC-42)
- Motorcraft Custom Bright Metal Cleaner (ZC-15)
- Motorcraft Detail Wash (ZC-3-A)
- Motorcraft Dusting Cloth (ZC-24)
- Motorcraft Engine Shampoo and Degreaser (U.S. only) (ZC-20)
- Motorcraft Engine Shampoo (Canada only) (CXC-66-A)
- Motorcraft Multi-Purpose Cleaner (Canada only) (CXC-101)
- Motorcraft Premium Glass Cleaner (Canada only) (CXC-100)

- Motorcraft Premium Quality Windshield Washer Fluid (Canada only) [CXC-37-(A, B, D or F)]
- Motorcraft Premium Windshield Wash Concentrate with Bitterant (U.S. only) (ZC-32-B2)
- Motorcraft Professional Strength Carpet & Upholstery Cleaner (ZC-54)
- Motorcraft Premium Leather and Vinyl Cleaner (ZC-56)
- Motorcraft Spot and Stain Remover (U.S. only) (ZC-14)
- Motorcraft Ultra-Clear Spray Glass Cleaner (ZC-23)
- Motorcraft Wheel and Tire Cleaner (ZC-37-A)

## CLEANING THE EXTERIOR

Wash your vehicle regularly with cool or lukewarm water and a neutral pH shampoo, such as Motorcraft Detail Wash.

- Never use strong household detergents or soap, such as dish washing or laundry liquid. These products can discolor and spot painted surfaces.
- Never wash a vehicle that is “hot to the touch” or during exposure to strong, direct sunlight.
- Dry your vehicle with a chamois or soft terry cloth towel in order to eliminate water spotting.
- Immediately remove items such as gasoline, diesel fuel, bird droppings and insect deposits because they can cause damage to your vehicle’s paintwork and trim over time. Use Motorcraft Bug and Tar Remover.
- Remove any exterior accessories, such as antennas, before entering a car wash.

**Note:** *Suntan lotions and insect repellents can damage any painted surface; if these substances come in contact with your vehicle, wash off as soon as possible.*

# Vehicle Care

---

## Stripes or Graphics (if equipped)

Do not use a commercial or high-pressure sprayer on the surface or edge of stripes and graphics. This can cause damage to the film and cause the edge of the film to peel away from the vehicle surface.

## Exterior Chrome

**Note:** *Never use abrasive materials such as steel wool or plastic pads as they can scratch the chrome surface.*

**Note:** *Do not use chrome cleaner, metal cleaner or polish on wheels and wheel covers*

- Wash your vehicle first, using cool or lukewarm water and a neutral pH shampoo, such as Motorcraft Detail Wash.
- Use Motorcraft Custom Bright Metal Cleaner. Apply the product as you would a wax to clean bumpers and other chrome parts; allow the cleaner to dry for a few minutes, then wipe off the haze with a clean, dry rag.

- Do not apply cleaning product to hot surfaces and do not leave cleaning product on chrome surfaces longer than the time recommended.
- Using other non-recommended cleaners can result in severe and permanent cosmetic damage.

## Underbody

Flush the complete underside of your vehicle frequently. Keep body and door drain holes free from packed dirt.

## Cleaning Plastic Exterior Parts

Use only approved products to clean plastic parts

- For routine cleaning, use Motorcraft Detail Wash.
- If tar or grease spots are present, use Motorcraft Bug and Tar Remover.

## WAXING

Regular waxing is necessary to protect your car's paint from the elements. We recommend that you wash and wax the painted surface once or twice a year.

When washing and waxing, park your vehicle in a shaded area out of direct sunlight. Always wash your vehicle before applying wax.

- Use a quality wax that does not contain abrasives.
- Follow the manufacturer's instructions to apply and remove the wax.
- Apply a small amount of wax in a back-and-forth motion, not in circles.

# Vehicle Care

---

- Do not allow wax to come in contact with any non-body (low-gloss black) colored trim. The wax will discolor or stain the parts over time.
  - Roof racks.
  - Bumpers.
  - Grained door handles.
  - Side moldings.
  - Mirror housings.
  - Windshield cowl area.
- Do not apply wax to glass areas.
- After waxing, your car's paint should feel smooth, and be free of streaks and smudges.

## CLEANING THE ENGINE

Engines are more efficient when they are clean because grease and dirt buildup keep the engine warmer than normal.

When washing:

- Take care when using a power washer to clean the engine. The high-pressure fluid could penetrate the sealed parts and cause damage.
- Do not spray a hot engine with cold water to avoid cracking the engine block or other engine components.
- Spray Motorcraft Engine Shampoo and Degreaser on all parts that require cleaning and pressure rinse clean. In Canada, use Motorcraft Engine Shampoo.
- Never wash or rinse the engine while it is hot or running; water in the running engine may cause internal damage.
- Never wash or rinse any ignition coil, spark plug wire or spark plug well, or the area in and around these locations.
- Cover the battery, power distribution box, and air filter assembly to prevent water damage when cleaning the engine.

## CLEANING THE WINDOWS AND WIPER BLADES

Car wash chemicals and environmental fallout can result in windshield and wiper blade contamination. Dirty windshield and wipers will result in poor windshield wiper operation. Keep the windshield and wiper blades clean to maintain windshield wiper performance.

To clean the windshield and wiper blades:

- Clean the windshield with a non-abrasive glass cleaner.
- For windshields contaminated with tree sap, chemicals, wax or bugs, clean the entire windshield using steel wool (no greater than 0000 grade) in a circular motion and rinse with water.
- Clean the wiper blades with isopropyl rubbing alcohol or windshield washer fluid.

**Note:** Do not use razor blades or other sharp objects to clean or remove decals from the inside of the heated rear window. The vehicle warranty does not cover damage caused to the heated rear window grid lines.

# Vehicle Care

## CLEANING THE INTERIOR

### WARNINGS



Do not use cleaning solvents, bleach or dye on the vehicle's safety belts, as these actions may weaken the belt webbing.



On vehicles equipped with seat-mounted airbags, do not use chemical solvents or strong detergents. Such products could contaminate the side airbag system and affect performance of the side airbag in a collision.

**Note:** Follow the same procedure for cleaning leather seats when cleaning leather interior. See **Cleaning Leather Seats** (page 307).

**Note:** Do not use household cleaning products or glass cleaners, which can stain and discolor the fabric and affect the flame retardant abilities of the seat materials.

For fabric, carpets, cloth seats, safety belts and seats equipped with side airbags:

- Remove dust and loose dirt with a vacuum cleaner.
- Remove light stains and soil with Motorcraft Professional Strength Carpet & Upholstery Cleaner.

For grease or tar stains:

- Spot clean the area with Motorcraft Spot and Stain Remover (Motorcraft Multi-Purpose Cleaner in Canada).
- If a ring forms on the fabric after spot cleaning, clean the entire area immediately (but do not oversaturate) or the ring will set.

## Cleaning Black Label Interior (If Equipped)

**Note:** Alcantara microfiber cloth fabric is made of polyester microfiber with micro-porous polyurethane. Using commercially available fabric cleaners can cause permanent damage.

**Note:** Do not use commercially available leather and vinyl cleaning products on Alcantara microfiber cloth fabric.

**Note:** Lincoln Black Label vehicles may have Alcantara microfiber cloth fabric on the seats, headliner, floor mats and door panels.

Depending on the type of stain, use water, lemon juice or pure ethyl alcohol when cleaning:

# Vehicle Care

Type of Stain	Cleaning Procedure
Fruit juice, jam, jelly, syrup or ketchup.	Use lukewarm water and rinse by dabbing with clean water.
Blood, egg, excrement or urine.	Use cold water and rinse by dabbing with clean water. Avoid warm water because it makes these substances coagulate.
Liquor, alcoholic beverages, wine, beer, cola and tea.	Use lukewarm water. If the color remains, treat with lemon juice and then rinse.
Indelible pencil, cocoa, chocolate, pastry with cream or chocolate, ice-cream or mustard.	Use lukewarm water and rinse by dabbing with clean water.
Vinegar, hair gel, tomato sauce or coffee with sugar.	Use lemon juice, wipe with lukewarm water and rinse by dabbing with clean water.

## CLEANING THE INSTRUMENT PANEL AND INSTRUMENT CLUSTER LENS

### WARNING



Do not use chemical solvents or strong detergents when cleaning the steering wheel or instrument panel to avoid contamination of the airbag system.

**Note:** Follow the same procedure as cleaning leather seats for cleaning leather instrument panels and leather interior trim surfaces. See **Cleaning Leather Seats** (page 307).

Clean the instrument panel and cluster lens with a clean, damp and soft cloth, then use a clean, dry and soft cloth to dry these areas.

- Avoid cleaners or polishes that increase the gloss of the upper portion of the instrument panel. The dull finish in this area helps protect you from undesirable windshield reflection.
- Do not use any household cleaning products or glass cleaners as these may damage the finish of the instrument panel, interior trim and cluster lens.

# Vehicle Care

---

- Wash or wipe your hands clean if you have been in contact with certain products such as insect repellent and suntan lotion to avoid possible damage to the interior painted surfaces.
- Do not allow air fresheners and hand sanitizers to spill onto interior surfaces. If a spill occurs, wipe off immediately. Your warranty may not cover these damages.

If a staining liquid like coffee or juice has been spilled on the instrument panel or on interior trim surfaces:

1. Wipe up spilled liquid using a clean, soft cloth as quickly as possible.
  2. Use Motorcraft Premium Leather and Vinyl Cleaner or a commercially available leather cleaning product for automotive interiors. Test any cleaner or stain remover on an inconspicuous area.
  3. Alternatively, wipe the surface with a clean, soft cloth and a mild soap and water solution. Dry the area with a clean, soft cloth.
4. If necessary, apply more soap and water solution or cleaning product to a clean, soft cloth and press it onto the soiled area. Allow this to set at room temperature for 30 minutes.
  5. Remove the soaked cloth, then with a clean, damp cloth, use a rubbing motion for 60 seconds on the soiled area.
  6. Dry the area with a clean, soft cloth.

## **CLEANING LEATHER SEATS** (if

**Equipped)**

**Note:** *Follow the same procedure as cleaning leather seats for cleaning leather instrument panels and leather interior trim surfaces.*

For routine cleaning, wipe the surface with a soft, damp cloth and a mild soap and water solution. Dry the area with a clean, soft cloth.

For cleaning and removing spots and stains such as dye transfer, use Motorcraft Premium Leather and Vinyl Cleaner or a commercially available leather cleaning product for automotive interiors.

**Note:** *Test any cleaner or stain remover on an inconspicuous area.*

You should:

- Remove dust and loose dirt with a vacuum cleaner.
- Clean and treat spills and stains as soon as possible.

Do not use the following products as these may damage the leather:

- Oil and petroleum or silicone-based leather conditioners.
- Household cleaners.
- Alcohol solutions.
- Solvents or cleaners intended specifically for rubber, vinyl and plastics.

# Vehicle Care

---

## REPAIRING MINOR PAINT DAMAGE

Authorized dealers have touch-up paint to match your vehicle's color. Your vehicle color code is printed on a sticker on the front, left-hand side door jamb. Take your color code to your authorized dealer to make sure you get the correct color.

Before repairing minor paint damage, use a cleaner such as Motorcraft Bug and Tar Remover to remove particles such as bird droppings, tree sap, insect deposits, tar spots, road salt and industrial fallout.

Always read the instructions before using cleaning products.

## CLEANING THE ALLOY WHEELS

**Note:** Do not apply a cleaning chemical to warm or hot wheel rims and covers.

**Note:** Some automatic car washes may cause damage to the finish on your wheel rims and covers.

**Note:** Industrial-strength or heavy-duty cleaners in combination with brush agitation to remove brake dust and dirt, could wear away the clear coat finish over a period time.

**Note:** Do not use hydrofluoric acid-based or high caustic-based wheel cleaners, steel wool, fuels or strong household detergents.

**Note:** If you intend parking your vehicle for an extended period after cleaning the wheels with a wheel cleaner, drive your vehicle for a few minutes before doing so. This will reduce the risk of increased corrosion of the brake discs.

Alloy wheels and wheel covers are coated with a clear coat paint finish. To maintain their condition we recommend that you:

- Clean the wheels weekly using Motorcraft Wheel and Tire Cleaner. Apply using manufacturer's instructions.
- Use a sponge to remove heavy deposits of dirt and brake dust accumulation.

- Rinse thoroughly with a strong stream of water when you have completed the cleaning process.
- To remove tar and grease, use Motorcraft Bug and Tar Remover.

## VEHICLE STORAGE

If you plan on storing your vehicle for 30 days or more, read the following maintenance recommendations to make sure your vehicle stays in good operating condition.

We engineer and test all motor vehicles and their components for reliable, regular driving. Under various conditions, long-term storage may lead to degraded engine performance or failure unless you use specific precautions to preserve engine components.

# Vehicle Care

---

## General

- Store all vehicles in a dry, ventilated place.
- Protect from sunlight, if possible.
- If vehicles are stored outside, they require regular maintenance to protect against rust and damage.

## Body

- Wash your vehicle thoroughly to remove dirt, grease, oil, tar or mud from exterior surfaces, rear-wheel housing and the underside of front fenders.
- Periodically wash your vehicle if it is stored in exposed locations.
- Touch-up exposed or primed metal to prevent rust.
- Cover chrome and stainless steel parts with a thick coat of auto wax to prevent discoloration. Re-wax as necessary when you wash your vehicle.
- Lubricate all hood, door and trunk lid hinges, and latches with a light grade oil.

- Cover interior trim to prevent fading.
- Keep all rubber parts free from oil and solvents.

## Engine

- The engine oil and filter should be changed prior to storage because used engine oil contains contaminants that may cause engine damage.
- Start the engine every 15 days for a minimum of 15 minutes. Run at fast idle with the climate controls set to defrost until the engine reaches normal operating temperature.
- With your foot on the brake, shift through all the gears while the engine is running.
- We recommend that you change the engine oil before you use your vehicle again.

## Fuel system

- Fill the fuel tank with high-quality fuel until the first automatic shutoff of the fuel pump nozzle.

## Cooling system

- Protect against freezing temperatures.
- When removing your vehicle from storage, check coolant fluid level. Confirm that there are no cooling system leaks and that fluid is at the recommended level.

## Battery

- Check and recharge as necessary. Keep connections clean.
- If storing your vehicle for more than 30 days without recharging the battery, we recommend that you disconnect the battery cables to maintain battery charge for quick starting.

**Note:** *It is necessary to reset memory features if battery cables are disconnected.*

## Brakes

- Make sure the brakes and parking brake release fully.

## Tires

- Maintain recommended air pressure.

# Vehicle Care

---

## Miscellaneous

- Make sure all linkages, cables, levers and pins under your vehicle are covered with grease to prevent rust.
- Move vehicles at least 25 ft (7.5 m) every 15 days to lubricate working parts and prevent corrosion.

## Removing Vehicle From Storage

When your vehicle is ready to come out of storage, do the following:

- Wash your vehicle to remove any dirt or grease film build-up on window surfaces.
- Check windshield wipers for any deterioration.
- Check under the hood for any foreign material that may have collected during storage such as mice or squirrel nests.
- Check the exhaust for any foreign material that may have collected during storage.
- Check tire pressures and set tire inflation per the Tire Label.

- Check brake pedal operation. Drive your vehicle 15 ft (4.5 m) back and forth to remove rust build-up.
- Check fluid levels (including coolant, oil and gas) to make sure there are no leaks, and fluids are at recommended levels.
- If you remove the battery, clean the battery cable ends and inspect.

Contact an authorized dealer if you have any concerns or issues.

# Wheels and Tires

## TEMPORARY MOBILITY KIT

### Type 1

**Note:** The temporary mobility kit canister contains enough sealant compound for one tire repair only. See your authorized Ford dealer for additional replacement sealant canisters.

The kit is located under the load floor of the trunk. The kit consists of an air compressor to inflate the tire and a sealing compound in a canister that will effectively seal most punctures caused by nails or similar objects. This kit will provide a temporary tire repair allowing you to drive your vehicle up to 120 mi (200 km) at a maximum speed of 50 mph (80 km/h) to reach a tire service location.

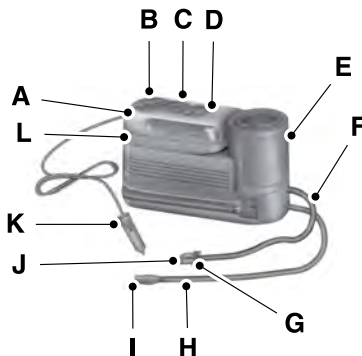

E144618

- A Air compressor (inside)
- B Diverter knob
- C On and off button

- D Air pressure gauge
- E Sealant bottle and canister
- F Sealant filling clear tube
- G Sealant tube - tire valve connector
- H Yellow cap tool
- I Air compressor hose
- J Air hose -tire valve connector
- K Accessory power plug
- L Casing/housing

### General Information

#### WARNING



Failure to follow these guidelines could result in an increased risk of loss of vehicle control, injury or death.

**Note:** Do not use the kit if a tire has become severely damaged by driving the vehicle with a tire that has insufficient air pressure. Only punctured areas located within the tire tread can be sealed with the kit.

# Wheels and Tires

---

Do not attempt to repair punctures larger than 0.24 in (6 mm) or damage to the tire's sidewall. The tire may not completely seal.

Loss of air pressure may adversely affect tire performance. For this reason:

**Note:** Do not drive the vehicle above 50 mph (80 km/h).

**Note:** Do not drive further than 120 mi (200 km). Drive only to the closest authorized Ford dealer or tire repair shop to have your tire inspected.

- Drive carefully and avoid abrupt steering maneuvers.
- Periodically monitor tire inflation pressure in the affected tire. If the tire is losing pressure, have the vehicle towed.
- Read the information in the Tips for Use of the Kit section to make sure safe operation of the kit and your vehicle.

## Tips for Use of the Kit

To ensure safe operation of the kit:

- Read all instructions and cautions fully.
- Before operating the kit, make sure your vehicle is safely off the road and away from moving traffic. Turn on the hazard lights.
- Always set the parking brake to ensure the vehicle does not move unexpectedly.
- Do not remove any foreign objects, such as nails or screws, from the tire.
- When using the kit, leave the engine running (only if the vehicle is outdoors or in a well-ventilated area) so the compressor does not drain the vehicle battery.
- Do not allow the compressor to operate continuously for more than 15 minutes. This will help prevent the compressor from overheating.
- Never leave the kit unattended when it is operating.
- Sealant compound contains latex. Make sure that you use the non-latex gloves provided to avoid an allergic reaction.
- Keep the kit away from children.
- Only use the kit when the ambient temperature is between -22°F (-30°C) and 158°F (70°C).
- Only use the sealing compound before the use by date. The use by date is on the lower right hand corner of the label located on the sealant canister (bottle). Check the use by date regularly and replace the canister after four years.
- Do not store the kit unsecured inside the passenger compartment of the vehicle as it may cause injury during a sudden stop or crash. Always store the kit in its original location.
- After sealant use, the tire pressure monitoring system sensor and valve stem on the wheel must be replaced by an authorized Ford dealer.
- When inflating a tire or other objects, use the black air hose only. Do not use the transparent hose which is designed for sealant application only.
- Operating the kit could cause an electrical disturbance in radio, CD, and DVD player operation.

# Wheels and Tires

## What to do when a Tire Is Punctured

A tire puncture within the tire tread area can be repaired in two stages with the kit.

- In the first stage, the tire will be reinflated with a sealing compound and air. After the tire has been reinflated, you will need to drive the vehicle a short distance 4 mi (6 km) to distribute the sealant in the tire.
- In the second stage, you will need to check the tire pressure and adjust, if necessary, to the vehicle tire inflation pressure.

## First Stage: Reinflating the Tire with Sealing Compound and Air

### WARNINGS



Do not stand directly over the kit while inflating the tire. If you notice any unusual bulges or deformations in the tire sidewall during inflation, stop and call roadside assistance.



If the tire does not inflate to the recommended tire pressure within 15 minutes, stop and call roadside assistance.

Preparation: Park the vehicle in a safe, level and secure area, away from moving traffic. Turn the hazard lights on. Apply the parking brake and turn the engine off. Inspect the flat tire for visible damage.

Sealant compound contains latex. To avoid any allergic reactions, use the non-latex gloves located in the accessory box on the underside of the kit housing.

Do not remove any foreign object that has pierced the tire. If a puncture is located in the tire sidewall, stop and call roadside assistance.

1. Remove the valve cap from the tire valve.
2. Unwrap the clear tube from the compressor housing.
3. Remove the tube cap and fasten the metal connector of the tube to the tire valve, turning clockwise. Make sure the connection is tightly fastened.



E144619

4. Plug the power cable into the 12-volt power point in the vehicle.
5. Remove the warning sticker found on the canister and place it on the top of the instrument panel or the center of the dash.
6. Start the vehicle only if the vehicle is outdoors or in a well-ventilated area.

# Wheels and Tires

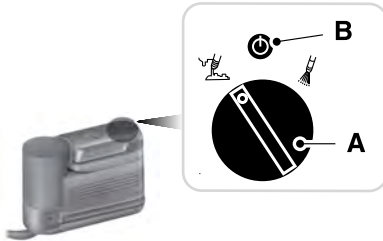

E144924

7. Push and turn dial (A) counterclockwise to the sealant position. Turn on the kit by pressing the on/off button (B).



E144621

8. Inflate the tire to the pressure specified by the tire label located on the driver door or the door jamb area. While the sealant compound is being pumped into the tire, the air pressure gauge will indicate a pressure above the actual tire pressure. This is normal and should be no reason for concern. The pressure gauge will provide a correct tire pressure reading after about 30 seconds of operation. The tire pressure has to be checked with the compressor in the off position to get an accurate tire pressure reading.
9. When the recommended tire pressure is reached, turn off the kit by pressing the on/off button. Disconnect the kit from the tire valve and the power point. Re-install the valve cap on the tire valve, place the tube cap on the metal connector, and return the kit to the stowage area
10. Immediately and cautiously, drive the vehicle 4 miles (6 kilometers) to distribute the sealant evenly inside the tire. Do not exceed 50 mph (80 km/h).

11. After 4 miles (6 kilometers), stop and check the tire pressure. See Second stage: Checking tire pressure.

**Note:** *If you experience any unusual vibration, ride disturbance or noise while driving, reduce your speed until you can safely pull off to the side of the road to call for roadside assistance. Note: Do not proceed to the second stage of this operation.*

## Second Stage: Checking Tire Pressure

### WARNINGS

 If you are proceeding from the First stage: Re-inflating the tire with sealing compound and air section and have injected sealant in the tire and the pressure is below 20 psi (1.4 bar), stop and call roadside assistance. If tire pressure is above 20 psi (1.4 bar), continue to the next step.

 The power plug may get hot after use and should be handled carefully while unplugging.

Check the air pressure of your tires as follows:

# Wheels and Tires

1. Remove the valve cap from the tire valve.
2. Unhook the black hose from the side of the compressor and fasten firmly on the valve stem by turning clockwise.
3. Push and turn the dial clockwise to the air position. Turn on the kit by pressing the on button.

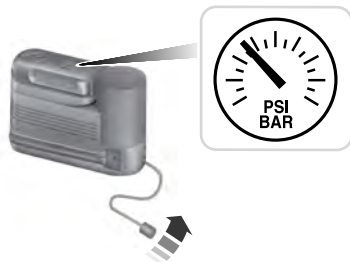

E144622

4. Adjust the tire to the recommended inflation pressure from the tire label located on the driver door or door jamb area. The tire pressure has to be checked with the compressor in the OFF position to get the correct tire pressure reading.
5. Turn the compressor off by pressing the on/off button.

6. When the tire pressure reading with the compressor in the off position is correct, disconnect the hose, re-install the valve cap on the tire valve, unplug the compressor, and return the kit to the stowage area.

## What to do after the Tire has been Sealed

After using the kit to seal your tire, you will need to replace the sealant canister and clear tube (hose). You can obtain and replace sealing compound and spare parts at an authorized Ford dealer or tire dealer. Empty sealant bottles may be disposed of at home. However, liquid residue from the sealing compound should be disposed by your local Ford Motor Company dealer or tire dealer, or in accordance with local waste disposal regulations.

**Note:** After the sealing compound has been used, the maximum vehicle speed is 50 mph (80 km/h) and the maximum driving distance is 120 mi (200 km). The sealed tire should be inspected immediately.

**Note:** After sealant use, the tire pressure monitoring system sensor and valve stem on the wheel must be replaced by an authorized Ford dealer.

You can check the tire pressure any time within the 120 mi (200 km) by performing the procedure from Second stage: Checking tire pressure listed previously.

## Removal of the sealant canister from the kit



E144623

1. Unwrap the clear tube from the compressor housing.

# Wheels and Tires



E144624

2. Locate the yellow cap at the end of the clear tube.



E144625

3. Using the yellow cap tool, press the tab located on the kit compressor housing while pulling up on the sealant canister.

## Installation of the sealant canister to the kit

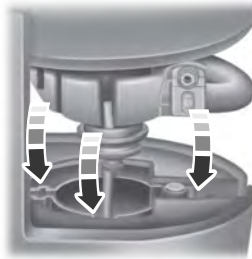

E144626

1. Align the sealant canister with the kit housing.



E161567

2. Once aligned, seat the sealant canister by lightly pushing down until you hear an audible click.



E144628

3. Wrap the clear tube around the compressor housing.

**Note:** If you experience any difficulties with the removal or installation of the sealant canister, consult your Ford Motor Company authorized dealer for assistance.

# Wheels and Tires

## Use By / Utiliser avant:

E144629

Be sure to check the sealant compound's use by date regularly. The use by date is on the lower right hand corner of the label located on the sealant canister (bottle). The sealant canister should be replaced after four years of non-use.

## Type 2

**Note:** *The temporary mobility kit contains enough sealant compound in the canister for one tire repair only. See your authorized Ford dealer for replacement sealant canisters.*

The kit is located under the load floor in the trunk. The kit consists of an air compressor to re-inflate the tire and a canister of sealing compound that will effectively seal most punctures caused by nails or similar objects. This kit will provide a temporary tire repair allowing you to drive your vehicle up to 120 (200 km) at a maximum speed of 50 mph (80 km/h) to reach a tire service location.

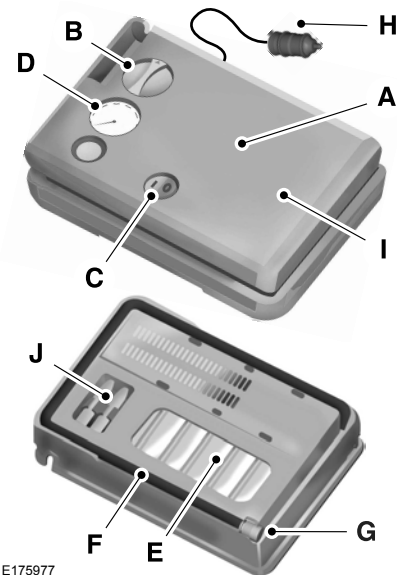

E175977

- A Air compressor (inside)
- B Selector switch
- C On and off button

# Wheels and Tires

- D Air pressure gauge
- E Sealant bottle and canister
- F Dual purpose hose: air and repair
- G Tire valve connector
- H Accessory power plug
- I Casing/housing
- J Bike/raft/sports ball adapters

## General Information

### WARNING

 Failure to follow these guidelines could result in an increased risk of loss of vehicle control, injury or death.

**Note:** *Do not use the kit if a tire has become severely damaged. Only punctures located within the tire tread can be sealed with the kit.*

Do not attempt to repair punctures larger than ¼ inch (6 millimeters) or damage to the tire's sidewall. The tire may not completely seal.

Loss of air pressure may adversely affect tire performance. For this reason:

**Note:** *Do not drive the vehicle above 50 mph (80 km/h).*

**Note:** *Do not drive further than 120 mi (200 km). Drive only to the closest authorized Ford dealer or tire repair shop to have your tire inspected.*

- Drive carefully and avoid abrupt steering maneuvers.
- Periodically monitor tire inflation pressure in the affected tire; if the tire is losing pressure, have the vehicle towed.
- Read the information in the Tips for Use of the Kit section to make sure safe operation of the kit and your vehicle.

## Tips for Use of the Kit

To ensure safe operation of the kit:

- Read all instructions and cautions fully.
- Before operating the kit, make sure your vehicle is safely off the road and away from moving traffic. Turn on the hazard lights.

- Always set the parking brake to ensure the vehicle doesn't move unexpectedly.
- Do not remove any foreign objects, such as nails or screws, from the tire.
- When using the kit, leave the engine running (only if the vehicle is outdoors or in a well-ventilated area) so the compressor does not drain the vehicle's battery.
- Do not allow the compressor to operate continuously for more than 15 minutes. This will help prevent the compressor from overheating.
- Never leave the kit unattended during operation.
- Sealant compound contains latex. Those with latex sensitivities should use appropriate precautions to avoid an allergic reaction.
- Keep the kit away from children.
- Only use the kit when the ambient temperature is between -22°F (-30°C) and 158°F (70°C).

# Wheels and Tires

- Only use the sealing compound before the use-by date. The use-by date is on a label on the sealant canister and can be seen through the rectangular viewing window on the bottom of the compressor. Check the use-by date regularly and replace the canister after four years of non-use.
- Do not store the kit unsecured inside the passenger compartment of the vehicle as it may cause injury during a sudden stop or crash. Always store the kit in its original location.
- After sealant use, the tire pressure monitoring system sensor and valve stem on the wheel must be replaced by an authorized Ford dealer.
- Operating the kit could cause an electrical disturbance in radio, CD, and DVD player operation.



\* When inflation only is required for a tire or other objects, the selector must be in the Air position.

## What to do when a Tire Is Punctured

A tire puncture within the tire's tread area can be repaired in two stages with the kit.

- In the first stage, the tire will be reinflated with a sealing compound and air. After the tire has been inflated, you will need to drive the vehicle a short distance (about 4 miles [6 kilometers]) to distribute the sealant in the tire.
- In the second stage, you will need to check the tire pressure and adjust, if necessary, to the vehicle's specified tire inflation pressure.

## First Stage: Reinflating the Tire with Sealing Compound and Air

### WARNINGS

 Do not stand directly over the kit while inflating the tire. If you notice any unusual bulges or deformations in the tire's sidewall during inflation, stop and call roadside assistance.

 If the tire does not inflate to the recommended tire pressure within 15 minutes, stop and call roadside assistance.

### WARNINGS

 Do not run the engine during kit operation unless the vehicle is outdoors or in a well-ventilated area.

Preparation: Park the vehicle in a safe, level and secure area, away from moving traffic.

Turn the hazard lights on. Apply the parking brake and turn the engine off. Inspect the flat tire for visible damage.

Sealant compound contains latex. Use appropriate precautions to avoid any allergic reactions.

Do not remove any foreign object that has pierced the tire. If a puncture is located in the tire sidewall, stop and call roadside assistance.

1. Remove the valve cap from the tire valve.
2. Unwrap the dual purpose hose (black tube) from the back of the compressor housing.
3. Fasten the hose to the tire valve by turning the connector clockwise. Tighten the connection securely.

## Wheels and Tires

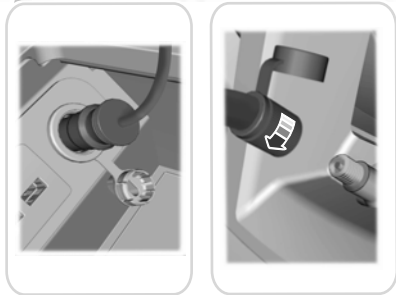

5. Remove the warning sticker found on the casing/housing and place it on the top of the instrument panel or the center of the dash.
6. Start the vehicle leave the engine running so the compressor does not drain the vehicle's battery.

E175979

4. Plug the power cable into the 12-volt power point in the vehicle.



E175981

7. Turn dial (A) clockwise to the sealant position. Turn the kit on by pressing the on/off button (B).

## Wheels and Tires

- Inflate the tire to the pressure listed on the tire label located on the driver's door or the door jamb area. The initial air pressure gauge reading may indicate a value higher than the label pressure while the sealing compound is being pumped into the tire. This is normal and should be no reason for concern. The pressure gauge reading will indicate the tire inflation pressure after about 30 seconds of operation. The final tire pressure should be checked with the compressor turned OFF in order to get an accurate pressure reading.

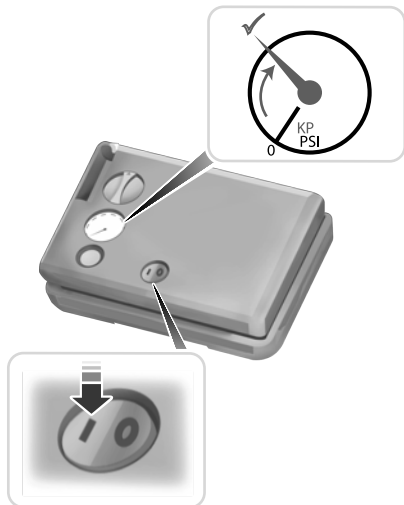

E175982

- When the recommended tire pressure is reached, turn off the kit, unplug the power cable, and disconnect the hose from the tire valve. Re-install the valve cap on the tire valve and return the kit to the storage area.
- Immediately and cautiously, drive the vehicle 4 miles (6 kilometers) to distribute the sealant evenly inside the tire. Do not exceed 50 mph (80 km/h).
- After 4 miles (6 kilometers), stop and check the tire pressure. See Second stage: Checking tire pressure.

**Note:** *If you experience any unusual vibration, ride disturbance or noise while driving, reduce your speed until you can safely pull off to the side of the road to call for roadside assistance. Note: Do not proceed to the second stage of this operation.*

# Wheels and Tires

## Second Stage: Checking Tire Pressure

### WARNINGS

 If you are proceeding from the First Stage: Re-inflating the Tire with Sealing Compound and Air section and have injected sealant in the tire and the pressure is below 20 psi (1.4 bar), continue to the next step.

 The power plug may get hot after use and should be handled carefully while unplugging.

Check the air pressure of your tires as follows:



E175983

1. Remove the valve cap from the tire valve.

2. Firmly screw the air compressor hose onto the valve stem by turning clockwise.
3. Push and turn the dial clockwise to the air position.
4. If required, turn on the compressor and adjust the tire to the recommended inflation pressure shown on the tire label located on the driver's door or door jamb area. The tire pressure should be checked with the compressor turned OFF in order to get an accurate pressure reading.
5. Unplug the hoses, re-install the valve cap on the tire and return the kit to the stowage area.

## What to do after the Tire has been Sealed

After using the kit to seal your tire, you will need to replace the sealant canister. Sealant canisters and spare parts can be obtained at an authorized Ford dealer. Empty sealant canisters may be disposed of at home. However, canisters still containing liquid sealant should be disposed of by your local authorized Ford dealer or tire dealer, or in accordance with local waste disposal regulation.

**Note:** *After the sealing compound has been used, the maximum vehicle speed is 50 mph (80 km/h) and the maximum driving distance is 120 mi (200 km). The sealed tire should be inspected immediately.*

You can check the tire pressure any time within the 120 mi (200 km) by performing the steps listed previously in the Second stage: Checking Tire Pressure procedure.

# Wheels and Tires

## Removal of the sealant canister from the kit

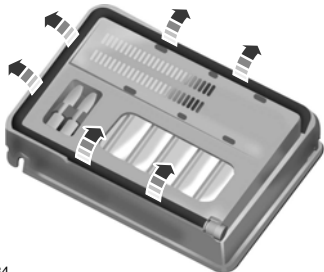

E175984

1. Unwrap the dual purpose hose (black tube) from the compressor housing.



E175985

2. Unwrap the power cord.



E175986

3. Remove the back cover.



E175987

4. Rotate the sealant canister up 90 degrees and pull away from casing/housing to remove.

## Installation of the sealant canister to the kit

1. With the canister held perpendicular to the housing, insert the canister nozzle into the connector and push until seated.
2. Rotate the canister 90 degrees down into the housing/casing.



E175988

3. Snap the back cover back into place.

# Wheels and Tires

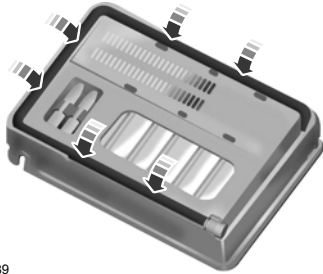

E175989

4. Wrap the dual purpose hose (black tube) around the channel on the bottom of the housing/casing.



E175990

5. Wrap the power cord around the housing and stow the accessory power plug into its storage area.

**Note:** *If you experience any difficulties with the removal or installation of the sealant canister, consult your authorized Ford dealer for assistance.*

Be sure to check the sealant compound's use-by date regularly. The use-by date is on a label located on the sealant canister and can be seen through the rectangular viewing window on the bottom of the kit. The sealant canister should be replaced after four years of non-use.

## TIRE CARE

### Information About Uniform Tire Quality Grading



E142542

Tire Quality Grades apply to new pneumatic passenger car tires. The Quality grades can be found where applicable on the tire sidewall between tread shoulder and maximum section width. For example: **Treadwear 200 Traction AA Temperature A.**

These Tire Quality Grades are determined by standards that the United States Department of Transportation has set.

# Wheels and Tires

Tire Quality Grades apply to new pneumatic passenger car tires. They do not apply to deep tread, winter-type snow tires, space-saver or temporary use spare tires, light truck or LT type tires, tires with nominal rim diameters of 10 to 12 inches or limited production tires as defined in Title 49 Code of Federal Regulations Part 575.104 (c)(2).

**U.S. Department of Transportation Tire quality grades:** The U.S. Department of Transportation requires Ford Motor Company to give you the following information about tire grades exactly as the government has written it.

## Treadwear

The treadwear grade is a comparative rating based on the wear rate of the tire when tested under controlled conditions on a specified government test course. For example, a tire graded 150 would wear one and one-half (1 ½) times as well on the government course as a tire graded 100. The relative performance

of tires depends upon the actual conditions of their use, however, and may depart significantly from the norm due to variations in driving habits, service practices, and differences in road characteristics and climate.

## Traction AA A B C

### WARNING



The traction grade assigned to this tire is based on straight-ahead braking traction tests, and does not include acceleration, cornering, hydroplaning or peak traction characteristics.

The traction grades, from highest to lowest are AA, A, B, and C. The grades represent the tire's ability to stop on wet pavement as measured under controlled conditions on specified government test surfaces of asphalt and concrete. A tire marked C may have poor traction performance.

## Temperature A B C

### WARNING



The temperature grade for this tire is established for a tire that is properly inflated and not overloaded. Excessive speed, underinflation, or excessive loading, either separately or in combination, can cause heat buildup and possible tire failure.

The temperature grades are A (the highest), B and C, representing the tire's resistance to the generation of heat and its ability to dissipate heat when tested under controlled conditions on a specified indoor laboratory test wheel. Sustained high temperature can cause the material of the tire to degenerate and reduce tire life, and excessive temperature can lead to sudden tire failure. The grade C corresponds to a level of performance which all

# Wheels and Tires

---

passenger car tires must meet under the Federal Motor Vehicle Safety Standard No. 139. Grades B and A represent higher levels of performance on the laboratory test wheel than the minimum required by law.

## Glossary of Tire Terminology

- **Tire label:** A label showing the original equipment tire sizes, recommended inflation pressure and the maximum weight the vehicle can carry.
- **Tire Identification Number:** A number on the sidewall of each tire providing information about the tire brand and manufacturing plant, tire size and date of manufacture. Also referred to as DOT code.
- **Inflation pressure:** A measure of the amount of air in a tire.
- **Standard load:** A class of P-metric or Metric tires designed to carry a maximum load at 35 psi [37 psi (2.5 bar) for Metric tires]. Increasing the inflation pressure beyond this pressure will not increase the tire's load carrying capability.
- **Extra load:** A class of P-metric or Metric tires designed to carry a heavier maximum load at 41 psi [43 psi (2.9 bar) for Metric tires]. Increasing the inflation pressure beyond this pressure will not increase the tire's load carrying capability.
- **kPa:** Kilopascal, a metric unit of air pressure.
- **PSI:** Pounds per square inch, a standard unit of air pressure.
- **Cold inflation pressure:** The tire pressure when the vehicle has been stationary and out of direct sunlight for an hour or more and prior to the vehicle being driven for 1 mile (1.6 km).
- **Recommended inflation pressure:** The cold inflation pressure found on the Safety Compliance Certification Label (affixed to either the door hinge pillar, door-latch post, or the door edge that meets the door-latch post, next to the driver's seating position), or Tire Label located on the B-Pillar or the edge of the driver's door.
- **B-pillar:** The structural member at the side of the vehicle behind the front door
- **Bead area of the tire:** Area of the tire next to the rim.
- **Sidewall of the tire:** Area between the bead area and the tread.
- **Tread area of the tire:** Area of the perimeter of the tire that contacts the road when mounted on the vehicle.
- **Rim:** The metal support (wheel) for a tire or a tire and tube assembly upon which the tire beads are seated.

# Wheels and Tires

## Information Contained on the Tire Sidewall

Both U.S. and Canada Federal regulations require tire manufacturers to place standardized information on the sidewall of all tires. This information identifies and describes the fundamental characteristics of the tire and also provides a U.S. DOT Tire Identification Number for safety standard certification and in case of a recall.

## Information on P Type Tires

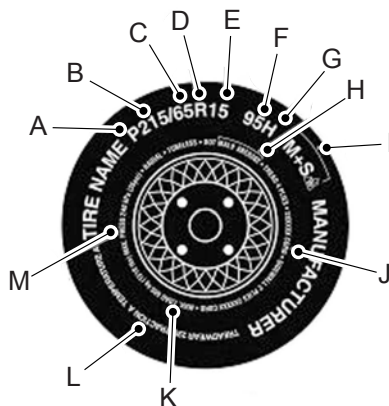

E142543

P215/65R15 95H is an example of a tire size, load index and speed rating. The definitions of these items are listed below. (Note that the tire size, load index and speed rating for your vehicle may be different from this example.)

A. **P**: Indicates a tire, designated by the Tire and Rim Association, that may be used for service on cars, sport utility vehicles, minivans and light trucks. **Note:** If your tire size does not begin with a letter this may mean it is designated by either the European Tire and Rim Technical Organization or the Japan Tire Manufacturing Association.

B. **215**: Indicates the nominal width of the tire in millimeters from sidewall edge to sidewall edge. In general, the larger the number, the wider the tire.

C. **65**: Indicates the aspect ratio which gives the tire's ratio of height to width.

D. **R**: Indicates a radial type tire.

E. **15**: Indicates the wheel or rim diameter in inches. If you change your wheel size, you will have to purchase new tires to match the new wheel diameter.

# Wheels and Tires

**F. 95:** Indicates the tire's load index. It is an index that relates to how much weight a tire can carry. You may find this information in your owner's manual. If not, contact a local tire dealer.

**Note:** You may not find this information on all tires because it is not required by federal law.

**G. H:** Indicates the tire's speed rating. The speed rating denotes the speed at which a tire is designed to be driven for extended periods of time under a standard condition of load and inflation pressure. The tires on your vehicle may operate at different conditions for load and inflation pressure. These speed ratings may need to be adjusted for the difference in conditions. The ratings range from 81 mph (130 km/h) to 186 mph (299 km/h). These ratings are listed in the following chart.

**Note:** You may not find this information on all tires because it is not required by federal law.

Letter rating	Speed rating
M	81 mph (130 km/h)
N	87 mph (140 km/h)
Q	99 mph (159 km/h)
R	106 mph (171 km/h)
S	112 mph (180 km/h)
T	118 mph (190 km/h)
U	124 mph (200 km/h)
H	130 mph (210 km/h)
V	149 mph (240 km/h)

Letter rating	Speed rating
W	168 mph (270 km/h)
Y	186 mph (299 km/h)

**Note:** For tires with a maximum speed capability over 149 mph (240 km/h), tire manufacturers sometimes use the letters ZR. For those with a maximum speed capability over 186 mph (299 km/h), tire manufacturers always use the letters ZR.

## H. U.S. DOT Tire Identification Number:

This begins with the letters DOT and indicates that the tire meets all federal standards. The next two numbers or letters are the plant code designating where it was manufactured, the next two are the tire size code and the last four numbers represent the week and year the tire was built. For example, the numbers 317 mean the 31st week of 1997. After 2000 the numbers go to four

## Wheels and Tires

---

digits. For example, 2501 means the 25th week of 2001. The numbers in between are identification codes used for traceability. This information is used to contact customers if a tire defect requires a recall.

I. **M+S or M/S:** Mud and Snow, or

**AT:** All Terrain, or

**AS:** All Season.

### J. **Tire Ply Composition and Material**

**Used:** Indicates the number of plies or the number of layers of rubber-coated fabric in the tire tread and sidewall. Tire manufacturers also must indicate the ply materials in the tire and the sidewall, which include steel, nylon, polyester, and others.

K. **Maximum Load:** Indicates the maximum load in kilograms and pounds that can be carried by the tire. Refer to the Safety Compliance Certification Label (affixed to either the door hinge pillar, door-latch post, or the door edge that meets the door-latch post, next to the driver's seating position), for the correct tire pressure for your vehicle.

### L. **Treadwear, Traction and Temperature Grades:**

- **Treadwear** The treadwear grade is a comparative rating based on the wear rate of the tire when tested under controlled conditions on a specified government test course. For example, a tire graded 150 would wear one and one-half times as well on the government course as a tire graded 100.
- **Traction:** The traction grades, from highest to lowest are AA, A, B, and C. The grades represent the tire's ability to stop on wet pavement as measured under controlled conditions on specified government test surfaces of asphalt and concrete. A tire marked C may have poor traction performance.
- **Temperature:** The temperature grades are A (the highest), B and C, representing the tire's resistance to the generation of heat and its ability to dissipate heat when tested under controlled conditions on a specified indoor laboratory test wheel.

# Wheels and Tires

## M. Maximum Permissible Inflation

**Pressure:** Indicates the tire manufacturers' maximum permissible pressure or the pressure at which the maximum load can be carried by the tire. This pressure is normally higher than the vehicle manufacturer's recommended cold inflation pressure which can be found on the Safety Compliance Certification Label (affixed to either the door hinge pillar, door-latch post, or the door edge that meets the door-latch post, next to the driver's seating position), or Tire Label which is located on the B-Pillar or the edge of the driver's door. The cold inflation pressure should never be set lower than the recommended pressure on the vehicle label.

The tire suppliers may have additional markings, notes or warnings such as standard load, radial tubeless, etc.

## Additional Information Contained on the Tire Sidewall for LT Type Tires

**Note:** *Tire Quality Grades do not apply to this type of tire.*

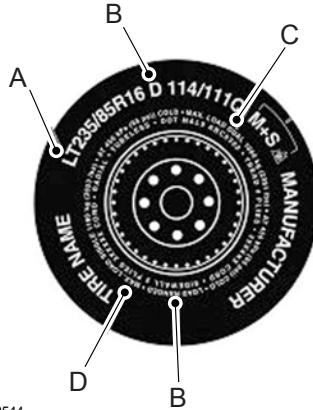

E142544

LT type tires have some additional information beyond those of P type tires; these differences are described below.

**A. LT:** Indicates a tire, designated by the Tire and Rim Association, that is intended for service on light trucks.

**B. Load Range and Load Inflation Limits:** Indicates the tire's load-carrying capabilities and its inflation limits.

**C. Maximum Load Dual lb (kg) at psi (kPa) cold:** Indicates the maximum load and tire pressure when the tire is used as a dual; defined as four tires on the rear axle (a total of six or more tires on the vehicle).

**D. Maximum Load Single lb (kg) at psi (kPa) cold:** Indicates the maximum load and tire pressure when the tire is used as a single; defined as two tires (total) on the rear axle.

## Information on T Type Tires

T145/80D16 is an example of a tire size.

**Note:** *The temporary tire size for your vehicle may be different from this example. Tire Quality Grades do not apply to this type of tire.*

# Wheels and Tires

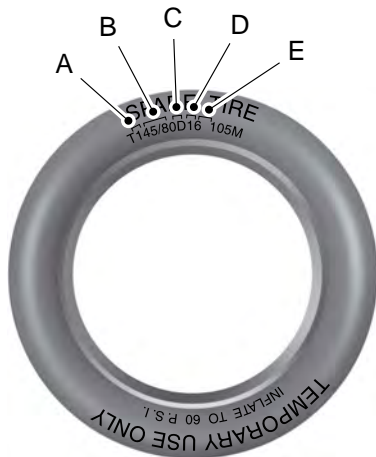

E142545

T type tires have some additional information beyond those of P type tires; these differences are described below:

A. **T:** Indicates a type of tire, designated by the Tire and Rim Association, that is intended for temporary service on cars, sport utility vehicles, minivans and light trucks.

B. **145:** Indicates the nominal width of the tire in millimeters from sidewall edge to sidewall edge. In general, the larger the number, the wider the tire.

C. **80:** Indicates the aspect ratio which gives the tire's ratio of height to width. Numbers of 70 or lower indicate a short sidewall.

D. **D:** Indicates a diagonal type tire.

**R:** Indicates a radial type tire.

E. **16:** Indicates the wheel or rim diameter in inches. If you change your wheel size, you will have to purchase new tires to match the new wheel diameter.

## Location of the Tire Label

You will find a Tire Label containing tire inflation pressure by tire size and other important information located on the B-Pillar or the edge of the driver's door.

## Inflating Your Tires

Safe operation of your vehicle requires that your tires are properly inflated. Remember that a tire can lose up to half of its air pressure without appearing flat.

Every day before you drive, check your tires. If one looks lower than the others, use a tire gauge to check pressure of all tires and adjust if required.

At least once a month and before long trips, inspect each tire and check the tire pressure with a tire gauge (including spare, if equipped). Inflate all tires to the inflation pressure recommended by Ford Motor Company.

# Wheels and Tires

---

You are strongly urged to buy a reliable tire pressure gauge, as automatic service station gauges may be inaccurate. Ford recommends the use of a digital or dial-type tire pressure gauge rather than a stick-type tire pressure gauge.

Use the recommended cold inflation pressure for optimum tire performance and wear. Under-inflation or over-inflation may cause uneven treadwear patterns

## WARNING



Under-inflation is the most common cause of tire failures and may result in severe tire cracking, tread separation or blowout, with unexpected loss of vehicle control and increased risk of injury. Under-inflation increases sidewall flexing and rolling resistance, resulting in heat buildup and internal damage to the tire. It also may result in unnecessary tire stress, irregular wear, loss of vehicle control and accidents. A tire can lose up to half of its air pressure and not appear to be flat!

Always inflate your tires to the Ford recommended inflation pressure even if it is less than the maximum inflation pressure information found on the tire. The Ford recommended tire inflation pressure is found on the Safety Compliance Certification Label (affixed to either the door hinge pillar, door-latch post, or the door edge that meets the door-latch post, next to the driver's seating position), or Tire Label which is located on the B-Pillar or the edge of the driver's door. Failure to follow the tire pressure recommendations can cause uneven treadwear patterns and adversely affect the way your vehicle handles

### Maximum Permissible Inflation

**Pressure** is the tire manufacturer's maximum permissible pressure and the pressure at which the maximum load can be carried by the tire. This pressure is normally higher than the manufacturer's recommended cold inflation pressure which can be found on the Safety Compliance Certification Label (affixed to either the door hinge

pillar, door-latch post, or the door edge that meets the door-latch post, next to the driver's seating position), or Tire Label which is located on the B-Pillar or the edge of the driver's door. The cold inflation pressure should never be set lower than the recommended pressure on the Safety Compliance Certification Label or Tire Label.

When weather temperature changes occur, tire inflation pressures also change. A 10°F (6°C) temperature drop can cause a corresponding drop of 1 psi (7 kPa) in inflation pressure. Check your tire pressures frequently and adjust them to the proper pressure which can be found on the Safety Compliance Certification Label or Tire Label.

To check the pressure in your tire(s):

1. Make sure the tires are cool, meaning they are not hot from driving even a mile.

# Wheels and Tires

---

**Note:** *If you are checking tire pressure when the tire is hot, (for example driven more than 1 mile [1.6 kilometers]), never bleed or reduce air pressure. The tires are hot from driving and it is normal for pressures to increase above recommended cold pressures. A hot tire at or below recommended cold inflation pressure could be significantly under-inflated.*

**Note:** *If you have to drive a distance to get air for your tire(s), check and record the tire pressure first and add the appropriate air pressure when you get to the pump. It is normal for tires to heat up and the air pressure inside to go up as you drive.*

2. Remove the cap from the valve on one tire, then firmly press the tire gauge onto the valve and measure the pressure.
3. Add enough air to reach the recommended air pressure.

**Note:** *If you overfill the tire, release air by pressing on the metal stem in the center of the valve. Then recheck the pressure with your tire gauge.*

4. Replace the valve cap.
5. Repeat this procedure for each tire, including the spare.

**Note:** *Some spare tires operate at a higher inflation pressure than the other tires. For T type mini-spare tires (refer to the Dissimilar spare wheel and tire assembly information for a description): Store and maintain at 60 psi (4.15 bar). For full-size and dissimilar spare tires (refer to the Dissimilar spare wheel and tire assembly information for a description): Store and maintain at the higher of the front and rear inflation pressure as shown on the Tire Label.*

6. Visually inspect the tires to make sure there are no nails or other objects embedded that could poke a hole in the tire and cause an air leak.

7. Check the sidewalls to make sure there are no gouges, cuts or bulges.

## Inspecting Your Tires and Wheel Valve Stems

Periodically inspect the tire treads for uneven or excessive wear and remove objects such as stones, nails or glass that may be wedged in the tread grooves. Check the tire and valve stems for holes, cracks, or cuts that may permit air leakage and repair or replace the tire and replace the valve stem. Inspect the tire sidewalls for cracking, cuts, bruises and other signs of damage or excessive wear. If internal damage to the tire is suspected, have the tire demounted and inspected in case it needs to be repaired or replaced. For your safety, tires that are damaged or show signs of excessive wear should not be used because they are more likely to blow out or fail.

# Wheels and Tires

Improper or inadequate vehicle maintenance can cause tires to wear abnormally. Inspect all your tires, including the spare, frequently, and replace them if one or more of the following conditions exist:

## Tire Wear

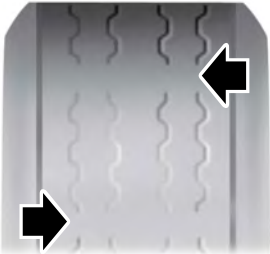

E142546

When the tread is worn down to one sixteenth of an inch (2 mm), tires must be replaced to help prevent your vehicle from skidding and hydroplaning. Built-in treadwear indicators, or wear bars, which look like narrow strips of smooth rubber across the tread will appear on the tire when the tread is worn down to one sixteenth of an inch (2 mm)

When the tire tread wears down to the same height as these wear bars, the tire is worn out and must be replaced.

## Damage

Periodically inspect the tire treads and sidewalls for damage (such as bulges in the tread or sidewalls, cracks in the tread groove and separation in the tread or sidewall). If damage is observed or suspected have the tire inspected by a tire professional. Tires can be damaged during off-road use, so inspection after off-road use is also recommended.

## Age

### WARNING



Tires degrade over time depending on many factors such as weather, storage conditions, and conditions of use (load, speed, inflation pressure, etc.) the tires experience throughout their lives.

In general, tires should be replaced after six years regardless of tread wear. However, heat caused by hot climates or frequent high loading conditions can accelerate the aging process and may require tires to be replaced more frequently.

You should replace your spare tire when you replace the road tires or after six years due to aging even if it has not been used.

# Wheels and Tires

## U.S. DOT Tire Identification Number

Both U.S. and Canada Federal regulations require tire manufacturers to place standardized information on the sidewall of all tires. This information identifies and describes the fundamental characteristics of the tire and also provides a U.S. DOT Tire Identification Number for safety standard certification and in case of a recall.

This begins with the letters DOT and indicates that the tire meets all federal standards. The next two numbers or letters are the plant code designating where it was manufactured, the next two are the tire size code and the last four numbers represent the week and year the tire was built. For example, the numbers 317 mean the 31st week of 1997. After 2000 the numbers go to four digits. For example, 2501 means the 25th week of 2001. The numbers in between are identification codes used for traceability. This information is used to contact customers if a tire defect requires a recall.

## Tire Replacement Requirements

Your vehicle is equipped with tires designed to provide a safe ride and handling capability.

### WARNINGS



Only use replacement tires and wheels that are the same size, load index, speed rating and type (such as P-metric versus LT-metric or all-season versus all-terrain) as those originally provided by Ford. The recommended tire and wheel size may be found on either the Safety Compliance Certification Label (affixed to either the door hinge pillar, door-latch post, or the door edge that meets the door-latch post, next to the driver's seating position), or the Tire Label which is located on the B-Pillar or edge of the driver's door. If this information is not found on these labels then you should contact your authorized dealer as soon as possible. Use of any tire or wheel not recommended by Ford can affect the safety and performance of your vehicle, which could result in an increased risk

### WARNINGS

of loss of vehicle control, vehicle rollover, personal injury and death. Additionally the use of non-recommended tires and wheels could cause steering, suspension, axle, transfer case or power transfer unit failure. If you have questions regarding tire replacement, contact your authorized dealer as soon as possible.



To reduce the risk of injury, when mounting replacement tires and wheels, you should not exceed the maximum pressure indicated on the sidewall of the tire to set the beads without additional precautions listed below. If the beads do not seat at the maximum pressure indicated, re-lubricate and try again

When inflating the tire for mounting pressures up to 20 psi (1.38 bar) greater than the maximum pressure on the tire sidewall, the following precautions must be taken to protect the person mounting the tire:

# Wheels and Tires

---

## WARNINGS

1. Make sure that you have the correct tire and wheel size.
2. Lubricate the tire bead and wheel bead seat area again.
3. Stand at a minimum of 12 feet (3.66 meters) away from the wheel and tire assembly.
4. Use both eye and ear protection.

For a mounting pressure more than 20 psi (1.38 bar) greater than the maximum pressure, a Ford dealer or other tire service professional should do the mounting.

Always inflate steel carcass tires with a remote air fill with the person inflating standing at a minimum of 12 feet (3.66 meters) away from the wheel and tire assembly

---

**Important:** Remember to replace the wheel valve stems when the road tires are replaced on your vehicle

It is recommended that the two front tires or two rear tires generally be replaced as a pair.

The tire pressure sensors mounted in the wheels (originally installed on your vehicle) are not designed to be used in aftermarket wheels.

The use of wheels or tires not recommended by Ford Motor Company may affect the operation of your tire pressure monitoring system.

If the TPMS indicator is flashing, your TPMS is malfunctioning. Your replacement tire might be incompatible with your TPMS, or some component of the TPMS may be damaged.

## Safety Practices

### WARNINGS



If your vehicle is stuck in snow, mud or sand, do not rapidly spin the tires; spinning the tires can tear the tire and cause an explosion. A tire can explode in as little as three to five seconds.



Do not spin the wheels at over 35 mph (56 km/h). The tires may fail and injure a passenger or bystander.

---

Driving habits have a great deal to do with your tire mileage and safety.

- Observe posted speed limits.
- Avoid fast starts, stops and turns.
- Avoid potholes and objects on the road.
- Do not run over curbs or hit the tire against a curb when parking.

# Wheels and Tires

---

## Highway Hazards

No matter how carefully you drive there's always the possibility that you may eventually have a flat tire on the highway. Drive slowly to the closest safe area out of traffic. This may further damage the flat tire, but your safety is more important.

If you feel a sudden vibration or ride disturbance while driving, or you suspect your tire or vehicle has been damaged, immediately reduce your speed. Drive with caution until you can safely pull off the road. Stop and inspect the tires for damage. If you cannot detect a cause, have the vehicle towed to the nearest repair facility or tire dealer to have the vehicle inspected.

## Tire and Wheel Alignment

A bad jolt from hitting a curb or pothole can cause the front end of your vehicle to become misaligned or cause damage to your tires. If your vehicle seems to pull to one side when you're driving, the wheels may be out of alignment. Have an authorized dealer check the wheel alignment periodically.

Wheel misalignment in the front or the rear can cause uneven and rapid treadwear of your tires and should be corrected by an authorized dealer. Front-wheel drive vehicles and those with an optional independent rear suspension may require alignment of all four wheels.

You should balance the tires periodically. An unbalanced tire and wheel assembly may result in irregular tire wear.

## Tire Rotation

**Note:** *If your tires show uneven wear ask an authorized dealer to check for and correct any wheel misalignment, tire imbalance or mechanical problem involved before tire rotation.*

**Note:** *Your vehicle may be equipped with a dissimilar spare wheel and tire assembly. A dissimilar spare wheel and tire assembly is defined as a spare wheel and tire assembly that is different in brand, size or appearance from the road tires and wheels. If you have a dissimilar spare wheel and tire assembly it is intended for temporary use only and should not be used in a tire rotation.*

**Note:** *After having your tires rotated, inflation pressure must be checked and adjusted to the vehicle requirements.*

Rotating your tires at the recommended interval (as indicated in the Scheduled Maintenance chapter) will help your tires wear more evenly, providing better tire performance and longer tire life.

# Wheels and Tires

Front-wheel drive or all-wheel drive vehicles (front tires on the left side of the diagram)

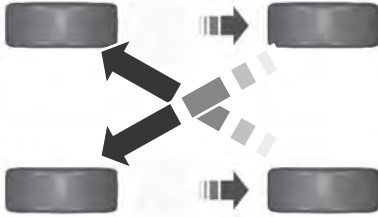

E142547

All vehicles with directional tires (front tires on the left side of the diagram)

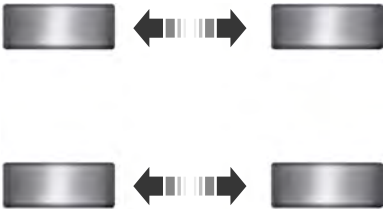

E147237

Sometimes irregular tire wear can be corrected by rotating the tires.

## Summer Tires

Your Ford vehicle may be equipped with summer tires to provide superior performance on wet and dry roads. Summer tires do not have the Mud and Snow (M+S or M/S) tire traction rating on the tire side wall. Since summer tires do not have the same traction performance as All-season or Snow tires, Ford does not recommend using summer tires when temperatures drop to approximately 40°F (5°C) or below (depending on tire wear and environmental conditions) or in snow and ice conditions. Like any tire, summer tire performance is affected by tire wear and environmental conditions. If you must drive in those conditions, Ford recommends using Mud and Snow (M+S, M/S), All-season or Snow tires.

## USING SNOW CHAINS

### WARNINGS

 If you choose to install snow tires on your vehicle, they must be the same size, construction, and load range as the original tires listed on the tire placard, and they must be installed on all four wheels. Mixing tires of different size or construction on your vehicle can adversely affect your vehicle's handling and braking, and may lead to loss of vehicle control.

 Do not use snow chains or cables on this vehicle as they may cause damage to your vehicle which may lead to loss of vehicle control.

Snow chains have not been approved for use on your vehicle.

The original equipment tires on your vehicle may have an all-weather tread design to provide traction, handling, and braking performance in year-round driving. You may install snow tires for improved traction when driving in areas with sustained periods of snow or icy driving conditions.

# Wheels and Tires

## TIRE PRESSURE MONITORING SYSTEM

### WARNING



The tire pressure monitoring system is NOT a substitute for manually checking tire pressure. The tire pressure should be checked periodically (at least monthly) using a tire gauge, see *Inflating your tires* in this chapter. Failure to properly maintain your tire pressure could increase the risk of tire failure, loss of control, vehicle rollover and personal injury.



Each tire, including the spare (if provided), should be checked monthly when cold and inflated to the inflation pressure recommended by the vehicle manufacturer on the vehicle placard or tire inflation pressure label. (If your vehicle has tires of a different size than the size indicated on the vehicle placard or tire inflation pressure label, you should determine the proper tire inflation pressure for those tires.)

As an added safety feature, your vehicle has been equipped with a tire pressure monitoring system (TPMS) that illuminates a low tire pressure telltale when one or more of your tires is significantly under-inflated. Accordingly, when the low tire pressure telltale illuminates, you should stop and check your tires as soon as possible, and inflate them to the proper pressure. Driving on a significantly under-inflated tire causes the tire to overheat and can lead to tire failure. Under-inflation also reduces fuel efficiency and tire tread life, and may affect the vehicle's handling and stopping ability.

Please note that the TPMS is not a substitute for proper tire maintenance, and it is the driver's responsibility to maintain correct tire pressure, even if under-inflation has not reached the level to trigger illumination of the TPMS low tire pressure telltale.

Your vehicle has also been equipped with a TPMS malfunction indicator to indicate when the system is not operating properly. The malfunction indicator is combined with the low tire pressure telltale. When the system detects a malfunction, the telltale will flash for approximately one minute and then remain continuously illuminated. This sequence will continue upon subsequent vehicle start-ups as long as the malfunction exists.

When the malfunction indicator is illuminated, the system may not be able to detect or signal low tire pressure as intended. TPMS malfunctions may occur for a variety of reasons, including the installation of replacement or alternate tires or wheels on the vehicle that prevent the TPMS from functioning properly. Always check the TPMS malfunction telltale after replacing one or more tires or wheels on your vehicle to ensure that the replacement or alternate tires and wheels allow the TPMS to continue to function properly.

# Wheels and Tires

The tire pressure monitoring system complies with part 15 of the FCC rules and with RSS-210 of Industry Canada. Operation is subject to the following two conditions: (1) This device may not cause harmful interference, and (2) This device must accept any interference received, including interference that may cause undesired operation.

## Changing Tires with a Tire Pressure Monitoring System



**Note:** *Each road tire is equipped with a tire pressure sensor located inside the wheel and tire assembly cavity. The pressure sensor is attached to the valve stem. The pressure sensor is covered by the tire and is not visible unless the tire is removed. Care must be taken when changing the tire to avoid damaging the sensor*

It is recommended that you always have your tires serviced by an authorized dealer.

The tire pressure should be checked periodically (at least monthly) using an accurate tire gauge. See *Inflating Your Tires* in this chapter.

## Understanding Your Tire Pressure Monitoring System

The tire pressure monitoring system measures pressure in your four road tires and sends the tire pressure readings to your vehicle. The low tire pressure warning light will turn on if the tire pressure is significantly low. Once the light is illuminated, your tires are under-inflated and need to be inflated to the manufacturer's recommended tire pressure. Even if the light turns on and a short time later turns off, your tire pressure still needs to be checked.

## When your Temporary Spare Tire is Installed (If Equipped)

When one of your road tires needs to be replaced with the temporary spare, the tire pressure monitoring system will continue to identify an issue to remind you that the damaged road wheel and tire assembly needs to be repaired and put back on your vehicle.

# Wheels and Tires

---

To restore the full functionality of the tire pressure monitoring system, have the damaged road wheel and tire assembly repaired and remounted on your vehicle.

## **When you Believe your System is not Operating Properly**

The main function of the tire pressure monitoring system is to warn you when your tires need air. It can also warn you in the event the system is no longer capable of functioning as intended. See the following chart for information concerning your tire pressure monitoring system:

# Wheels and Tires

Low tire pressure warning light	Possible cause	Customer action required
Solid warning light	Tire(s) under-inflated	1. Make sure tires are at the proper pressure. See Inflating your tires in this chapter. 2. After inflating your tires to the manufacturer's recommended pressure as shown on the Tire Label (located on the edge of driver's door or the B-Pillar), the vehicle must be driven for at least two minutes over 20 mph (32 km/h) before the light turns off.
	Spare tire in use	Repair the damaged road wheel and tire assembly and reinstall it on the vehicle to restore system functionality. For a description on how the system functions, see When your temporary spare tire is installed in this section.
	TPMS malfunction	If the tires are properly inflated and the spare tire is not in use but the light remains on, contact your authorized dealer as soon as possible.
Flashing warning light	Spare tire in use	Repair the damaged road wheel and tire assembly and reinstall it on the vehicle to restore system functionality. For a description on how the system functions, see When your temporary spare tire is installed in this section.
	TPMS malfunction	If the tires are properly inflated and the spare tire is not in use but the light remains on, contact your authorized dealer as soon as possible.

# Wheels and Tires

---

## **When Inflating your Tires**

When putting air into your tires (such as at a gas station or in your garage), the tire pressure monitoring system may not respond immediately to the air added to your tires.

It may take up to two minutes of driving over 20 mph (32 km/h) for the light to turn off after you have filled your tires to the recommended inflation pressure

## **How Temperature Affects your Tire Pressure**

The tire pressure monitoring system monitors tire pressure in each pneumatic tire. While driving in a normal manner, a typical passenger tire inflation pressure may increase approximately 2 to 4 psi (14 to 28 kPa) from a cold start situation. If the vehicle is stationary overnight with the outside temperature significantly lower than the daytime temperature, the tire pressure may decrease approximately 3 psi (21 kPa) for a drop of 30°F (17°C) in ambient temperature.

This lower pressure value may be detected by the TPMS as being significantly lower than the recommended inflation pressure and activate the TPMS warning light for low tire pressure. If the low tire pressure warning light is on, visually check each tire to verify that no tire is flat. (If one or more tires are flat, repair as necessary.) Check air pressure in the road tires. If any tire is under-inflated, carefully drive the vehicle to the nearest location where air can be added to the tires. Inflate all the tires to the recommended inflation pressure.

# Wheels and Tires

## TECHNICAL SPECIFICATIONS

### Wheel Lug Nut Torque Specifications

#### WARNING

 When a wheel is installed, always remove any corrosion, dirt or foreign materials present on the mounting surfaces of the wheel or the surface of the wheel hub, brake drum or brake disc that contacts the wheel. Make sure that any fasteners that attach the rotor to the hub are secured so they do not interfere with the mounting surfaces of the wheel. Installing wheels without correct metal-to-metal contact at the wheel mounting surfaces can cause the wheel nuts to loosen and the wheel to come off while your vehicle is in motion, resulting in loss of control.

Bolt size	lb-ft (Nm)
M12 x 1.5	100 (135)

Torque specifications are for nut and bolt threads free of dirt and rust. Use only Ford recommended replacement fasteners.

Retighten the lug nuts to the specified torque within 100 miles (160 kilometers) after any wheel disturbance (such as tire rotation, changing a flat tire, wheel removal).

# Wheels and Tires

---



E145950

## A Wheel pilot bore

Inspect the wheel pilot bore and mounting surface prior to installation. Remove any visible corrosion or loose particles.

# Capacities and Specifications

---

## ENGINE SPECIFICATIONS

Engine	2.0L ATK iVCT Engine
Cubic inches	122
Required fuel	Minimum 87 octane
Firing order	1-3-4-2
Ignition system	Coil on plug (COP)
Compression ratio	12.3:1
Spark plug gap	0.051 in. $\pm$ 0.002 in. (1.3 mm $\pm$ 0.05 mm)

# Capacities and Specifications

---

## MOTORCRAFT PARTS

Component	2.0L ATK iVCT Engine
Air filter element	FA-1911
Oil filter	FL-910-S
Battery	BXT-99RT4
Spark plugs	SP-530
Cabin air filter	FP-71
Windshield wiper blade	WW-2200 (driver side) WW-1900 (passenger side)

We recommend Motorcraft replacement parts available at your Lincoln dealer or at [fordparts.com](http://fordparts.com) for scheduled maintenance. These parts meet or exceed Ford Motor Company's specifications and are engineered for your vehicle. Use of other parts may impact vehicle performance, emissions and durability. Your warranty may be void for any damage related to use of other parts.

If a Motorcraft oil filter is not available, use an oil filter that meets industry performance specification SAE/USCAR-36.

For spark plug replacement, contact an authorized dealer. Replace the spark plugs at the appropriate intervals. See **Scheduled Maintenance** (page 468).

# Capacities and Specifications

## VEHICLE IDENTIFICATION NUMBER

The vehicle identification number is located on the left-hand side of the instrument panel.

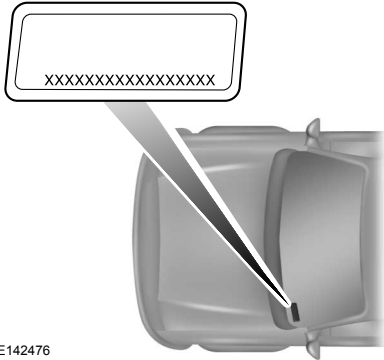

E142476

Please note that in the graphic, XXXX is representative of your vehicle identification number.

The Vehicle Identification Number contains the following information:

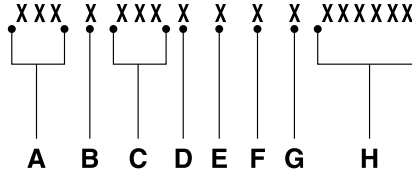

E142477

- A World manufacturer identifier
- B Brake system, Gross Vehicle Weight Rating, Restraint Devices and their locations
- C Make, vehicle line, series, body type
- D Engine type
- E Check digit
- F Model year
- G Assembly plant
- H Production sequence number

## VEHICLE CERTIFICATION LABEL

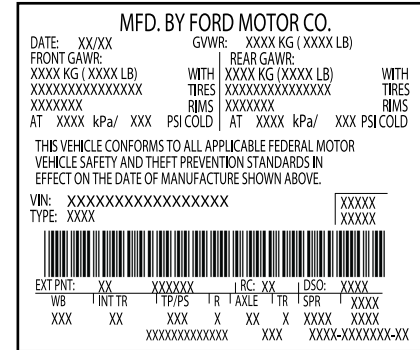

E167469

The National Highway Traffic Safety Administration Regulations require that a Safety Compliance Certification Label be affixed to a vehicle and prescribe where the Safety Compliance Certification Label may be located. The Safety Compliance Certification Label shall be affixed to either the door hinge pillar, the door latch post, or the edge of the door near the door latch, next to the driver's seating position.

# Capacities and Specifications

## TRANSMISSION CODE DESIGNATION

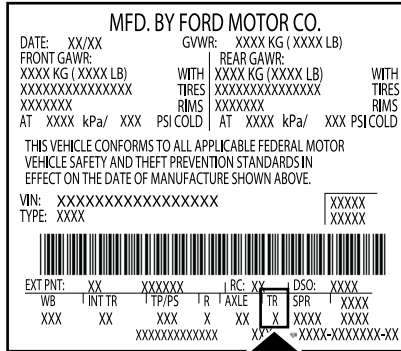

The transmission code is on the Safety Compliance Certification Label. The following table shows the transmission code along with the transmission description.

E167814

Description	Code
Electronic continuously variable transmission (ECVT), automatic, power split, shift by wire	J

# Capacities and Specifications

## CAPACITIES AND SPECIFICATIONS - 2.0L HYBRID

### Capacities

#### WARNING



The air conditioning refrigerant system contains refrigerant R-134a under high pressure. Opening the air conditioning refrigerant system can cause personal injury. Have the air conditioning refrigerant system serviced only by qualified personnel.

Item	Capacity
Engine oil	4.5 qt (4.3 L)
Engine coolant	7.4 qt (7 L)
Inverter system coolant	1.1 qt (1 L)
Brake fluid	Between MIN/MAX on brake fluid reservoir
Automatic transmission fluid <sup>1</sup>	4.8 qt (4.5 L)
Windshield washer fluid	Fill as required
Fuel tank	13.5 gal (51.1 L)
A/C Refrigerant	20 oz (0.57 kg)
A/C Refrigerant Compressor Oil	5.2 fl oz (155 ml)

<sup>1</sup> Approximate dry fill capacity. Actual amount may vary during fluid changes.

# Capacities and Specifications

## Specifications

### Materials

Name	Specification
Motor oil: Motorcraft SAE 0W-20 Synthetic Blend Motor Oil XO-0W20-QSP	WSS-M2C947-A
Engine coolant (U.S.): Motorcraft Orange Antifreeze/Coolant Prediluted VC-3DIL-B	WSS-M97B44-D2
Engine coolant (Canada): Motorcraft Orange Antifreeze/Coolant Prediluted CVC-3DIL-B	WSS-M97B44-D2
Inverter system controller coolant (U.S.) Motorcraft Orange Antifreeze/Coolant Prediluted VC-3DIL-B	WSS-M97B44-D2
Inverter system controller coolant (Canada) Motorcraft Orange Antifreeze/Coolant Prediluted CVC-3DIL-B	WSS-M97B44-D2
Brake fluid: Motorcraft DOT 4 Low Viscosity (LV) High Performance Motor Vehicle Brake Fluid PM-20	WSS-M6C65-A2

## Capacities and Specifications

Name	Specification
Automatic transmission fluid (U.S.): Motorcraft MERCON LV Automatic Transmission Fluid XT-10-QLVC	WSS-M2C938-A MERCON LV
Automatic transmission fluid (Canada): Motorcraft MERCON LV Automatic Transmission Fluid CXT-10-LV12	WSS-M2C938-A MERCON LV
Windshield washer fluid (U.S.): Motorcraft Premium Windshield Wash Concentrate with Bitterant ZC-32-B2	WSS-M14P19-A
Windshield washer fluid (Canada): Motorcraft Premium Quality Windshield Washer Fluid CXC-37-(A, B, D, F)	WSS-M14P19-A
A/C refrigerant (U.S.): Motorcraft R-134a Refrigerant YN-19	WSH-M17B19-A
A/C refrigerant (Canada): Motorcraft R-134a Refrigerant CYN-16-R	WSH-M17B19-A
A/C refrigerant compressor oil: Motorcraft Electric A/C Compressor Oil YN-32	--

# Capacities and Specifications

Name	Specification
Multi-purpose grease: Motorcraft Multi-Purpose Grease Spray XL-5	ESB-M1C93-B
Lock cylinders (U.S.): Penetrating and Lock Lubricant XL-1	--
Lock cylinders (Canada): Penetrating Fluid CXC-51-A	--

If you use oil and fluids that do not meet the defined specification and viscosity grade, this may lead to:

- Component damage which is not covered by the vehicle warranty.
- Longer engine cranking periods.
- Increased emission levels.
- Reduced engine performance.
- Reduced fuel economy.
- Degraded brake performance.

Use of synthetic or synthetic blend motor oil is not mandatory. Only use fluid that meets Ford specifications. Motor oils of the recommended viscosity grade that meet API SN requirements and display the API Certification Mark for gasoline engines are also acceptable. Do not use oil labeled with API SN service category unless the label also displays the API certification mark.



E142732

# Capacities and Specifications

---

An oil that displays this symbol conforms to current engine, emission system and fuel economy performance standards of the International Lubricant Standardization and Approval Committee (ILSAC).

Do not use supplemental engine oil additives because they are unnecessary and could lead to engine damage that may not be covered by your vehicle warranty.

**Note:** *Ford recommends using DOT 4 Low Viscosity (LV) High Performance Brake Fluid or equivalent meeting WSS-M6C65-A2. Use of any fluid other than the recommended fluid may cause degraded brake performance and not meet the Ford performance standards. Keep brake fluid clean and dry. Contamination with dirt, water, petroleum products or other materials may result in brake system damage and possible failure.*

**Note:** *Automatic transmissions that require MERCON LV transmission fluid should only use MERCON LV transmission fluid. The use of any other fluid may cause transmission damage.*

# Audio System

## GENERAL INFORMATION

### Radio Frequencies and Reception Factors

AM and FM frequencies are established by the Federal Communications Commission (FCC) and the Canadian Radio and Telecommunications Commission (CRTC). Those frequencies are:

- AM: 530, 540-1700, 1710 kHz
- FM: 87.9-107.7, 107.9 MHz

Radio Reception Factors	
Distance and Strength	The further you travel from an FM station, the weaker the signal and the weaker the reception.
Terrain	Hills, mountains, tall buildings, bridges, tunnels, freeway overpasses, parking garages, dense tree foliage and thunderstorms can interfere with the reception.
Station overload	When you pass a ground-based broadcast repeating tower, a stronger signal may overtake a weaker one and result in the audio system muting.

### CD and CD Player Information

**Note:** CD units play commercially pressed 4.75-inch (12 centimeter) audio compact discs only. Due to technical incompatibility, certain recordable and re-recordable compact discs may not function correctly when used in Ford CD players.

**Note:** Do not insert CDs with homemade paper (adhesive) labels into the CD player as the label may peel and cause the CD to become jammed. You should use a permanent felt tip marker rather than adhesive labels on your homemade CDs. Ballpoint pens may damage CDs. Please contact an authorized dealer for further information.

**Note:** Do not use any irregularly shaped discs or discs with a scratch protection film attached.

Always handle discs by their edges only. Clean the disc with an approved CD cleaner only. Wipe it from the center of the disc toward the edge. Do not clean in a circular motion.

# Audio System

---

Do not expose discs to direct sunlight or heat sources for extended periods.

## MP3 and WMA Track and Folder Structure

Audio systems capable of recognizing and playing MP3 and WMA individual tracks and folder structures work as follows:

- There are two different modes for MP3 and WMA disc playback: MP3 and WMA track mode (system default) and MP3 and WMA folder mode.
- MP3 and WMA track mode ignores any folder structure on the MP3 and WMA disc. The player numbers each MP3 and WMA track on the disc (noted by the MP3 or WMA file extension) from T001 to a maximum of T255. The maximum number of playable MP3 and WMA files may be less depending on the structure of the CD and exact model of radio present.

- MP3 and WMA folder mode represents a folder structure consisting of one level of folders. The CD player numbers all MP3 and WMA tracks on the disc (noted by the MP3 or WMA file extension) and all folders containing MP3 and WMA files, from F001 (folder) T001 (track) to F253 T255.
- Creating discs with only one level of folders helps with navigation through the disc files.

If you are burning your own MP3 and WMA discs, it is important to understand how the system reads the structures you create. While various files may be present, (files with extensions other than MP3 and WMA), only files with the MP3 and WMA extension are played; other files are ignored by the system. This enables you to use the same MP3 and WMA disc for a variety of tasks on your work computer, home computer and your in-vehicle system.

In track mode, the system displays and plays the structure as if it were only one level deep (all MP3 and WMA files play, regardless of being in a specific folder). In folder mode, the system only plays the MP3 and WMA files in the current folder.

## AUDIO UNIT - VEHICLES WITH: PREMIUM AM/FM/CD

### WARNING



Driving while distracted can result in loss of vehicle control, crash and injury. We strongly recommend that you use extreme caution when using any device that may take your focus off the road. Your primary responsibility is the safe operation of your vehicle. We recommend against the use of any hand-held device while driving and encourage the use of voice-operated systems when possible. Make sure you are aware of all applicable local laws that may affect the use of electronic devices while driving.

---

# Audio System

**Note:** The MyLincoln Touch system controls most of the audio features. See **Entertainment** (page 385).

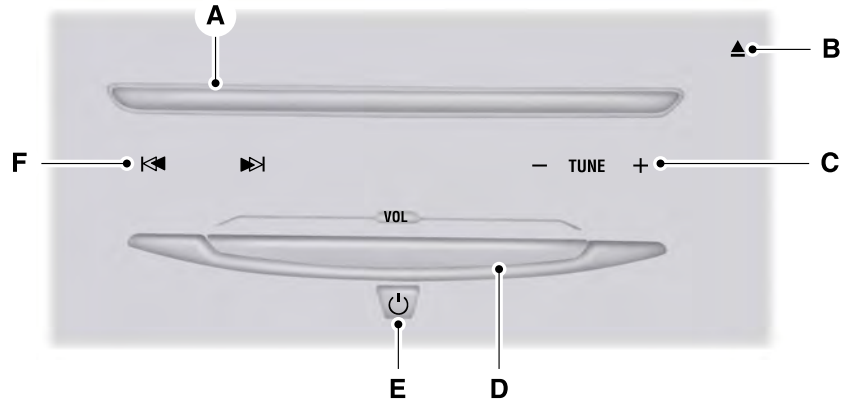

E146318

- A **CD slot:** Insert a CD.
- B **Eject:** Eject a CD.
- C **TUNE +/-:** In radio mode, select a frequency band and press one of the TUNE buttons. The system stops at the first station it finds in that direction. In SIRIUS mode, select the previous or next channel. If a specific category is selected, (Jazz, Rock, News, etc.), use the TUNE buttons find to the previous or next channel in the selected category.

# Audio System

---

- D **Volume:** Tap either side of the slider, or slide your finger across the control to increase or decrease the volume level on the system. To slowly increase or decrease the volume level, press and hold either end of the slider.
- E **Power:** Switch the audio system on and off by pressing the button.
- F **Seek/Fast Forward/Reverse:** Press to go to the previous or next track or available radio station. Press and hold to either reverse or fast forward through the current track or to quickly reverse or advance through the radio band in individual increments.

## MEDIA HUB

The media hub is located in the center console and has the following features:

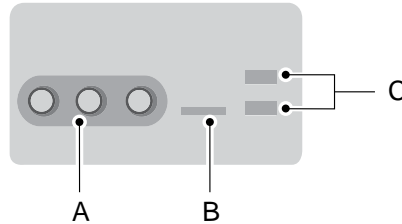

E142605

- A A/V inputs
- B SD card slot
- C USB ports

See **Entertainment** (page 385).

## GENERAL INFORMATION

### WARNING



Driving while distracted can result in loss of vehicle control, crash and injury. We strongly recommend that you use extreme caution when using any device that may take your focus off the road. Your primary responsibility is the safe operation of your vehicle. We recommend against the use of any hand-held device while driving and encourage the use of voice-operated systems when possible. Make sure you are aware of all applicable local laws that may affect the use of electronic devices while driving.

---

# MyLincoln Touch™

---

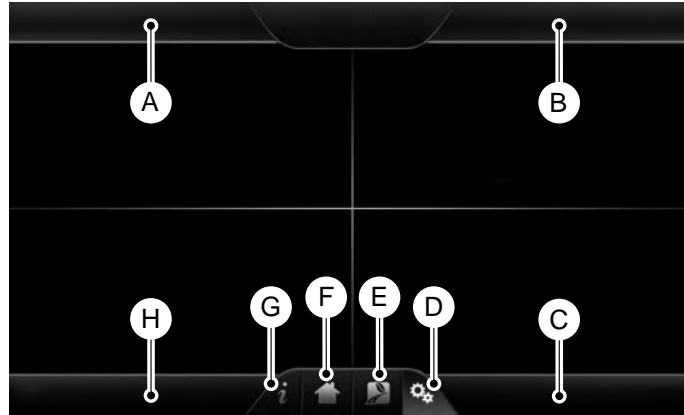

E161890

- A Phone
- B Navigation (or Information if your vehicle is not equipped with Navigation)
- C Climate
- D Settings
- E EV Information
- F Home

- G Information
- H Entertainment

This system uses a four-corner strategy to provide quick access to several vehicle features and settings. The touchscreen provides easy interaction with your cellular phone, multimedia, climate control and navigation system. The corners display any active modes within those menus, such as phone status or the climate temperature.

**Note:** *Some features are not available while your vehicle is moving.*

**Note:** *Your system is equipped with a feature that allows you to access and control audio features for 30 minutes after you switch the ignition off (and no doors open).*

## PHONE

Press to select any of the following:

- Phone
- Quick Dial
- Phonebook
- History

- Messaging
- Settings

## NAVIGATION

Press to select any of the following:

- My Home
- Favorites
- Previous Destinations
- Point of Interest
- Emergency
- Street Address
- Intersection
- City Center
- Map
- Edit Route
- Cancel Route

## CLIMATE

Press to select any of the following:

- Driver Settings
- Recirculated Air
- Auto
- Dual
- Passenger Settings
- A/C
- Defrost



## SETTINGS

Press to select any of the following:

- Clock
- Display
- Sound
- Vehicle
- Settings
- Help

# MyLincoln Touch™



## EV Information

Press to access features specific to your hybrid or plug-in hybrid electric vehicle.



## HOME

Press to access your home screen.

Depending on your vehicle's option package and software, your screens may vary in appearance from the descriptions in this section. Your features may also be limited depending on your market. Check with an authorized dealer for availability.



## INFORMATION

Press to select any of the following:

- Services
- Travel Link
- Alerts
- Calendar
- Apps

## ENTERTAINMENT

Press to select any of the following:

- AM
- FM
- SIRIUS
- CD
- USB
- BT Stereo
- SD Card
- A/V In

## Using the Touch-Sensitive Controls on Your System

To turn a feature on and off, just touch the graphic with your finger. To get the best performance from the touch-sensitive controls:

- Do not press hard on the controls. They are sensitive to light touch.
- Use your bare finger to touch the center of a touch-control graphic. Touching off-center of the graphic may affect operation of a nearby control.

- Make sure your hands are clean and dry.
- Keep metal and other conductive material away from the surface of the touchscreen as this may cause electronic interference (for example, inadvertently turning on a feature other than the one you meant to turn on).

Depending on your vehicle and option package, you may also have these controls on your bezel:

- **Power:** Switch the media or climate features off and on.
- **VOL:** Control the volume of playing media.
- **Seek and Tune:** Use as you normally would in media modes.
- **Eject:** Eject a CD from the entertainment system.
- **Climate control:** Control the temperature, fan speed or settings of the climate control system.

## Using Your Steering Wheel Controls

Depending on your vehicle and option package, you can use your steering wheel controls to interact with the touchscreen system.

- **VOL:** Control the volume of audio output.
- **Mute:** Mute the audio output.
- **Voice:** Press to start a voice session. Press again and hold to end a voice session.

- **SEEK and PHONE ACCEPT:**

- While in radio mode, press to seek between memory presets or press and hold to seek between stations.
- While in USB or CD mode, press to seek between stations or press and hold to fast seek.
- While in phone mode, press to answer a call, or to switch between calls.

- **SEEK and PHONE REJECT:**

- While in radio mode, press to seek between memory presets or press and hold to seek between stations.
- While in USB or CD mode, press to seek between stations or press and hold to fast seek.
- While in phone mode, press to end a call, or to reject an incoming call.

See **Steering Wheel** (page 78).

## Cleaning the Touchscreen Display

Use a clean, soft cloth such as one used for cleaning glasses. If dirt or fingerprints are still visible, apply a small amount of alcohol to the cloth. Do not pour or spray alcohol onto the display. Do not use detergent or any type of solvent to clean the display.

## Support

The SYNC support team is available to help you with any questions you are not able to answer on your own.

Monday-Saturday, 8:30am-9:00pm EST.

Sunday, 10:30am-7:30pm EST.

In the United States, call: 1-800-392-3673.

In Canada, call: 1-800-565-3673.

Times are subject to change due to holidays.

# MyLincoln Touch™

## Safety Information

### WARNING



Driving while distracted can result in loss of vehicle control, crash and injury. We strongly recommend that you use extreme caution when using any device that may take your focus off the road. Your primary responsibility is the safe operation of your vehicle. We recommend against the use of any hand-held device while driving and encourage the use of voice-operated systems when possible. Make sure you are aware of all applicable local laws that may affect the use of electronic devices while driving.

- Do not attempt to service or repair the system. See an authorized dealer.
- Do not operate playing devices if the power cords or cables are broken, split or damaged. Place cords and cables out of the way, so they do not interfere with the operation of pedals, seats, compartments or safe driving abilities.
- Do not leave playing devices in your vehicle during extreme conditions as it could cause them damage. See your device's user guide for further information.
- For your safety, some SYNC functions are speed-dependent. Their use is limited to when your vehicle is traveling at speeds under 3 mph (5 km/h).

Make sure that you review your device's manual before using it with SYNC.

## Speed-restricted Features

Some features of this system may be too difficult to use while your vehicle is moving so they are restricted from use unless your vehicle is stationary.

- Screens crowded with information, such as Point of Interest reviews and ratings, SIRIUS Travel Link sports scores, movie times or ski conditions.
- Any action that requires you to use a keyboard is restricted, such as entering a navigation destination or editing information.
- All lists are limited so the user can view fewer entries (such as phone contacts or recent phone call entries).

See the following chart for more specific examples.

Restricted Features	
Cellular Phone	Pairing a Bluetooth phone
	Adding phonebook contacts or uploading phonebook contacts (from a USB)
	List entries are limited for phone contacts and recent phone call entries

# MyLincoln Touch™

<b>Restricted Features</b>	
System Functionality	Editing the keypad code
	Enabling Valet Mode
	Editing settings while the rear view camera or active park assist are active
Wi-Fi and Wireless	Editing wireless settings
	Editing the list of wireless networks
Videos, Photos and Graphics	Playing video
	Editing the screen's wallpaper or adding new wallpaper
Text Messages	Composing text messages
	Viewing received text messages
	Editing preset text messages
Navigation	Using the keyboard to enter a destination
	Demo navigation route
	Adding or editing Address Book entries or Avoid Areas

## Privacy Information

When you connect a cellular phone to SYNC, the system creates a profile within your vehicle that links to that cellular phone. This profile helps in offering you more cellular features and operating more efficiently. Among other things, this profile may contain data about your cellular phone book, text messages (read and unread), and call history, including history of calls when your cell phone was not connected to the system. In addition, if you connect a media device, the system creates and retains an index of

supported media content. The system also records a short development log of approximately 10 minutes of all recent system activity. The log profile and other system data may be used to improve the system and help diagnose any problems that may occur.

The cellular profile, media device index, and development log remain in your vehicle unless you delete them and are generally accessible only in your vehicle when the cellular phone or media player is connected. If you no longer plan to use the system or your vehicle, we recommend you perform a Master Reset to erase all stored information.

System data cannot be accessed without special equipment and access to your vehicle's SYNC module. Ford Motor Company and Ford of Canada do not access the system data for any purpose other than as described absent consent, a court order, or where required by law enforcement, other government authorities, or other third parties acting with lawful authority. Other parties may seek to access the information independently of Ford Motor Company and Ford of Canada. For further privacy information, see the sections on 911 Assist, Vehicle Health Report, and Traffic, Directions and Information.

# MyLincoln Touch™

## Accessing and Adjusting Modes Through Your Right Vehicle Information Display (If Equipped)

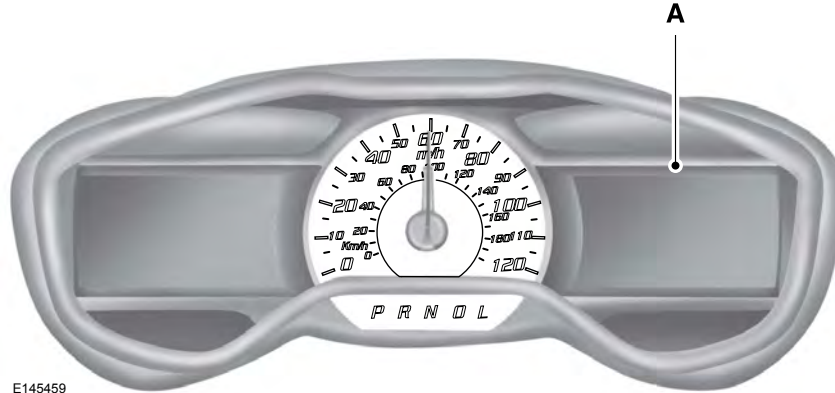

E145459

# MyLincoln Touch™

The display is located on the right side of your instrument cluster (A). You can use your steering wheel controls to view and make minor adjustments to active modes without taking your hands off the wheel. For example:

- In Entertainment mode, you can view what is now playing, change the audio source, select memory presets and make some adjustments.
- In Phone mode, you can accept or reject an incoming call.
- If your vehicle is equipped with Navigation, you can view the current route or activate a route.
- In Efficiency Leaves mode, you can learn how your vehicle informs you of your driving efficiency. Press **OK** to exit the menu.



E145982

Use the **OK** and arrow buttons on the right side of your steering wheel to scroll through the available modes:

The selection menu expands and different options appear.

- Press the up and down arrows to scroll through the modes.
- Press the right arrow to enter the mode.
- Press the left or right arrows to make adjustments within the chosen mode.
- Press **OK** to confirm your selection.

**Note:** If your vehicle is not equipped with Navigation, Compass appears in the display instead of Navigation. If you press the right arrow to go into the Compass menu, you can see the compass graphic. The compass displays the direction in which the vehicle is traveling, not true direction (for example, if the vehicle is traveling west, the middle of the compass graphic displays west; north displays to the left of west though its true direction is to the right of west).

## Using Voice Recognition

This system helps you control many features using voice commands. This allows you to keep your hands on the wheel and focus on what is in front of you. The system provides feedback through audible tones, prompts, questions and spoken confirmations depending on the situation and the chosen level of interaction (voice settings).

The system also asks short questions (confirmation prompts) when it is not sure of your request or when there are multiple possible responses to your request.

When using voice commands, words and icons may appear in the lower left status bar indicating the status of the voice session (such as Listening, Success, Failed, Paused or Try Again).

## How to Use Voice Commands with Your System



Press the voice icon. After the tone, speak your command clearly.

These commands can be said at any time during a voice session
"Cancel"
"Exit"
"Go back"
"List of commands"
"Main menu"
"Next page"

These commands can be said at any time during a voice session
"Previous page"
"What can I say?"
"Help"

## What Can I Say?

To access the available voice commands for the current session, do one of the following:

- During a voice session, press the help icon (?) in the lower left status bar of the screen.
- Say, "What can I say?" for an on-screen listing of the possible voice commands associated with your current voice session.
- Press the voice icon. After the tone, say, "Help" for an audible list of possible voice commands.

## Helpful Hints

- Make sure the interior of your vehicle is as quiet as possible. Wind noise from open windows and road vibrations may prevent the system from correctly recognizing spoken commands.
- After pressing the voice icon, wait until after the tone sounds and Listening appears before saying a command. Any command spoken before this does not register with the system.
- Speak naturally, without long pauses between words.
- At any time, you can interrupt the system while it is speaking by pressing the voice icon.

## Accessing a List of Available Commands

- If you use the touchscreen, press the Settings icon > **Help** > **Voice Command List**.
- If you use the steering wheel control, press the voice icon. After the tone, speak your command clearly.

# MyLincoln Touch™

Available voice commands
"Audio list of commands"
"Bluetooth audio list of commands"
"Browse list of commands"
"CD list of commands"
"Climate control list of commands"
"List of commands"
"Navigation list of commands"
"Phone list of commands"
"Radio list of commands"
"SD card list of commands"
"Sirius satellite list of commands"
"Travel link list of commands"
"USB list of commands"
"Voice instructions list of commands"

Available voice commands
"Voice settings list of commands"
"Help"

This command is only available when your vehicle is equipped with the navigation system, and the navigation system SD card is in the card slot.

This command is only available when you have an active SIRIUS satellite radio subscription.

## Voice Settings

Voice settings allow you to customize the level of system interaction, help and feedback. The system defaults to standard interaction that uses candidate lists and confirmation prompts as these provide the highest level of guidance and feedback.

- **Interaction Mode:** Novice mode provides detailed interaction and guidance while the advanced mode has less audible interaction and more tone prompts.
- **Confirmation Prompts:** The system uses these short questions to confirm your voice request. If turned off, the system simply makes a best guess as to what you requested. The system may still occasionally ask you to confirm settings.
- **Phone and Media Candidate Lists:** Candidate lists are lists of possible results from your voice commands. The system creates these lists when it has the same confidence level of several options based on your voice command.

To access these settings using the touchscreen:

1. Press the Settings icon > **Settings** > then **Voice Control**.
2. Select from the following:
  - Interaction Mode
  - Confirmation Prompts
  - Media Candidate Lists

- Phone Candidate Lists
- Voice Control Volume.

To access these settings using voice commands:

1. Press the voice icon. Wait for the prompt "Please say a command". Another tone sounds to let you know the system is listening.
2. Say any of the following commands:

<b>Voice settings using voice commands</b>
"Confirmation prompts off"
"Confirmation prompts on"
"Interaction mode advanced"
"Interaction mode novice"
"Media candidate lists off"
"Media candidate lists on"
"Phone candidate lists off"
"Phone candidate lists on"
"Help"

### ***Using Voice Commands with the Touchscreen Options***

Your voice system has a dual mode feature which allows you to switch between using voice commands and making on-screen selections. This is available only when the system displays a list of candidates generated during a voice session. For example, when entering in a street address or trying to call a contact from the phone you paired to the system.

## SETTINGS



- A Clock
- B Display
- C Sound
- D Vehicle
- E Settings
- F Help



Under this menu, you can set your clock, access and adjust the display, sound and vehicle settings as well as access settings for specific modes or the help feature.

## Clock

**Note:** *You cannot manually set the date. Your vehicle's GPS does this for you.*

**Note:** *If the battery has been disconnected, your vehicle needs to acquire a GPS signal to update the clock. Once your vehicle acquires the signal, it may take a few minutes for the update to display the correct time.*



1. Press the Settings icon > **Clock**.
2. Press + and - to adjust the time.

From this screen, you can also make other adjustments such as 12-hour or 24-hour mode, activate GPS time synchronization and have the system automatically update new time zones.

You can also turn the outside air temperature display off and on. It appears at the top center of the touchscreen, next to the time and date.

The system automatically saves any updates you make to the settings.

## Display

You can adjust the touchscreen display through the touchscreen or by pressing the voice button on your steering wheel controls and when prompted, say, "Display settings".



Press the Settings icon > **Display**, to access and make adjustments using the touchscreen.

- **Brightness** allows you to make the screen display brighter or dimmer.
- **Auto DIM**, when set to **On**, lets you use the Auto Dim Manual Offset feature. When set to **Off**, screen brightness does not change.

- **Mode** allows you to set the screen to a certain brightness or have the system automatically change based on the outside light level, or turn the display off.
  - If you select **AUTO** or **NIGHT**, you have the options of turning the display's Auto Dim feature on or off and changing the Auto Dim Manual Offset feature.
- **Auto Dim Manual Offset** allows you to adjust screen dimming as the outside lighting conditions change from day to night. This feature also allows you to adjust screen brightness using the instrument panel dimming control.
- **Edit Wallpaper**
  - You can have your touchscreen display the default photo or upload your own.

## Uploading Photos for Your Home Screen Wallpaper

**Note:** *You cannot load photos directly from your camera. You must access the photos either from your USB mass storage device or from an SD card.*

# MyLincoln Touch™

**Note:** Photographs with extremely large dimensions (such as 2048 x 1536) may not be compatible and appear as a blank (black) image on the display.

Your system allows you to upload and view up to 32 photos.



To access, press the Settings icon > **Display** > **Edit Wallpaper**, and then follow the system prompts to upload your photographs.

Only the photograph(s), which meets the following conditions, display:

- Compatible file formats are as follows: .jpg, .gif, .png, .bmp
- Each file must be 1.5 MB or less.
- Recommended dimensions: 800 x 384

## Sound



Press the **Settings** icon > **Sound**, then select from the following:

<b>Sound</b>
Bass
Midrange
Treble
Set Balance and Fade
DSP
THX Deep Note Demo
Occupancy Mode
Speed Compensated Volume

Your vehicle may not have these sound settings.

## Vehicle



Press the Settings icon > **Vehicle**, then select from the following:

- Ambient Lighting.
- Vehicle Health Report.

- Camera Settings.
- Enable Valet Mode.

## Ambient Lighting (If Equipped)

When you turn this feature on, ambient lighting illuminates footwells and cupholders with a choice of colors. To access and make adjustments:



1. Press the Settings icon > **Vehicle** > **Ambient Lighting**.
2. Touch the desired color.
3. Use the scroll bar to increase or decrease the intensity.

To turn the feature on or off, press the power button.

## Vehicle Health Report

Turn **Automatic Reminders** on and off and set the mileage interval at which you would like to receive the reports. Press ? for more information on these selections.

When done making your selections, press **Run Vehicle Health Report Now** if you want your report.

You can find more information on Vehicle Health Report in this chapter. See **Information** (page 419).

## Camera Settings

This menu allows you to access settings for your rear view camera.



Press the Settings icon > **Vehicle** > **Camera Settings**, then select from the following settings:

- Enhanced Park Aids.
- Rear Camera Delay.

You can find more information on the rear view camera in another chapter. See **Rear View Camera** (page 208).

## Enable Valet Mode

Valet mode allows you to lock the system. No information is accessible until the system is unlocked with the correct PIN. You can create your own four-digit PIN to lock and unlock the system.



1. Press the Settings icon > **Vehicle** > **Enable Valet Mode**.
2. Enter a four-digit pin twice, as prompted.

After you press **Continue**, the system locks until you enter the PIN again.

**Note:** *If the system locks, and you need to reset the PIN, enter 3681 and the system unlocks.*

## Settings

Access and adjust system settings, voice features, as well as phone, navigation and wireless settings.

## System



Press the Settings icon > **Settings** > **System**, then select from the following:

System	
Language	Select to have the touchscreen display in English, Spanish or French.
Distance	Select to display units in kilometers or miles.
Temperature	Select to display units in Celsius or Fahrenheit.
System Prompt Volume	Adjust the volume of voice prompts from the system.
Touch Screen Button Beep	Select to have the system beep to confirm choices made through the touchscreen.

# MyLincoln Touch™

System	
Touch Panel Button Beep	Select to have the system beep to confirm button choices made through the climate or audio system.
Keyboard Layout	Have the touchscreen keyboard display in QWERTY or ABC format.
Install Applications	Install any downloaded applications or view the current software licenses.
Master Reset	Select to restore factory defaults. This erases all personal settings and personal data.

## Voice Control



Press the Settings icon > **Settings**  
> **Voice Control**, then select from  
the following:

Voice control	
Interaction Mode	Standard interaction mode provides more detailed interaction and guidance. Advanced mode has less audible interaction and more tone prompts.
Confirmation Prompts	Have the system ask you short questions if it has not clearly heard or understood your request.
Media Candidate Lists	Candidate lists are possible results from your voice commands. The system simply makes a best guess at your request with these turned off.

# MyLincoln Touch™

Voice control	
Phone Candidate Lists	Candidate lists are possible results from your voice commands. The system simply makes a best guess at your request with these turned off.
Voice Control Volume	This allows you to adjust the system's voice volume level.

Even with confirmation prompts turned off, the system may occasionally ask you to confirm settings

## Media Player



Press the Settings icon > **Settings**  
> **Media Player**, then select from  
the following:

Media player	
Autoplay	When this feature is on, the system automatically switches to the media source upon initial connection. This allows you to listen to music during the indexing process. When this feature is off, the system does not automatically switch to the inserted media source.
Bluetooth Devices	Select to connect, disconnect, add or delete a device. You can also set a device as your favorite so that the system automatically attempts to connect to that device at every ignition cycle.
Index Bluetooth Audio Devices	When this feature is on, the system automatically indexes media on your connected Bluetooth device.

# MyLincoln Touch™

Media player	
Gracenote Database Info	This allows you to view the version level of the Gracenote Database.
Gracenote Management	With this feature on, the Gracenote Database supplies metadata information for your music files. This overrides information from your device. This feature defaults to off.
Cover Art Priority	With this feature on, the Gracenote Database supplied cover art for your music files. This overrides any art from your device. This feature defaults to Media Player.

## Navigation



Press the Settings icon > **Settings**  
> **Navigation**, then select from the following:

Navigation	
Map Preferences	Switch breadcrumbs on and off.
	Have the system display your turn list top to bottom or bottom to top.
	Switch the Parking POI notification on and off.

# MyLincoln Touch™

Navigation	
Route Preferences	Choose to have the system display the Shortest, Fastest or most Ecological route first. If you set <b>Always Use Preferred Route to Yes</b> , the system uses the selected route type to calculate only one route to the desired destination. <b>Always Use Preferred Route</b> bypasses route selection in destination programming. The system only calculates one route based on the preferred route setting. <b>Eco Time Penalty</b> allows you to select a low, medium or high cost for the calculated Eco Route. The higher the setting, the longer the time allotment is for the route.
	Have the system avoid freeways.
	Have the system avoid tollroads.
	Have the system avoid ferries or car trains.
	Have the system use HOV (high-occupancy vehicle) lanes.
Navigation Preferences	Have the system use guidance prompts.
	Have the system automatically fill-in State/Province information.
Traffic Preferences	Have the system display areas where roadwork occurs.
	Have the system display incident icons.
	Have the system display areas where difficult driving conditions may occur.
	Have the system display areas where snow and ice on the road may occur.
	Have the system display any smog alerts.
	Have the system display weather warnings.

# MyLincoln Touch™

Navigation	
	Have the system display where there may be reduced visibility.
	Have the system turn on your radio for traffic announcements.
	Have the system avoid traffic problems automatically.
	Switch traffic alert notifications on and off.
	Have the system display accident icons.
	Have the system display traffic jam icons.
	Have the system display closed roads.
Avoid Areas	Enter specific areas that you would like to avoid on planned navigation routes.

## Phone



Press the Settings icon > **Settings**  
> **Phone**, then select from the  
following:

# MyLincoln Touch™

Phone	
Bluetooth Devices	Connect, disconnect, add or delete a device, as well as save it as a favorite.
Bluetooth	Turn Bluetooth on and off.
Do Not Disturb	Have all calls go directly to your voice mail and not ring inside your vehicle. With this feature turned on, text message notifications are also suppressed and do not ring inside your vehicle.
911 Assist	Turn on or turn off the 911 Assist feature. See <b>Information</b> (page 419).
Phone Ringer	Select the type of notification for phone calls - ring tone, beep, text to speech, or have it be silent.
Text Message Notification	Select the type of notification for text messages - alert tone, beep, text to speech, or have it be silent.
Internet Data Connection	If compatible with your phone, you can adjust your internet data connection. Select to make your connection profile with the personal area network or to turn off your connection. You can also choose to adjust your settings or have the system always connect, never connect when roaming or query on connect. Press <b>?</b> for more information.
Manage Phonebook	Access features, such as automatic phonebook download, re-download your phonebook, add contacts from your phone as well as delete or upload your phonebook.
Roaming Warning	Have the system alert you when in Roaming mode.

# MyLincoln Touch™

## Wireless & Internet

Your system has a Wi-Fi feature that creates a wireless network within your vehicle, thereby allowing other devices (such as personal computers or phones) in your vehicle to speak to each other, share files or

play games. Using this Wi-Fi feature, everyone in your vehicle can also gain access the internet if you have a USB mobile broadband connection inside your vehicle, your phone supports personal area networking and if you park outside a wireless hotspot.



Press the Settings icon > **Settings** > **Wireless & Internet**, then select from the following:

Wi-fi	
Wi-Fi Settings	<b>Wi-Fi Network (Client) Mode</b> turns the Wi-Fi feature on and off in your vehicle. Make sure you turn it on for connectivity purposes.
	<b>Choose a Wireless Network</b> allows you to use a previously stored wireless network. You can categorize by alphabetical listing, priority and signal strength. You can also choose to search for a network, connect to a network, disconnect from a network, receive more information, prioritize a network or delete a network.
	<b>Gateway (Access Point) Mode</b> makes SYNC an access point for a phone or a computer when turned on. This forms the local area network within your vehicle for things, such as game playing, file transfer and internet browsing. Press ? for more information.
	<b>Gateway (Access Point) Settings</b> allows you to view and change settings for using SYNC as the internet gateway.
	<b>Gateway (Access Point) Device List</b> allows you to view recent connections to your Wi-Fi system.

# MyLincoln Touch™

Wi-fi	
USB Mobile Broadband	Instead of using Wi-Fi, your system can also use a USB mobile broadband connection to access the internet. (You must turn on your mobile broadband device on your personal computer before connecting it to the system.) This screen allows you to set up what is your typical area for your USB mobile broadband connection. (USB mobile broadband settings may not display if the device is already on.) You can select the following: Country, Carrier, Phone Number, User Name and Password.
Bluetooth Settings	Shows you the currently paired devices as well as giving you your typical Bluetooth options to connect, disconnect, set as favorite, delete and add device. Bluetooth is a registered trademark of the Bluetooth SIG.
Prioritize Connection Methods	Choose your connection methods and change them as needed. You can select to Change Order and have the system either always attempt to connect using a USB mobile broadband or using Wi-Fi.



The Wi-Fi  
CERTIFIED  
Logo is a

## Help



Press the Settings icon > **Help**,  
then select from the following:

E142626

certification mark of the Wi-Fi Alliance.

# MyLincoln Touch™

Help	
Where Am I?	View your vehicle's current location, if your vehicle is equipped with navigation. If your vehicle is not equipped with navigation, you do not see this button.
System Information	Touchscreen system serial number
	Your vehicle identification number (VIN)
	Touchscreen system software version
	Navigation system version
	Map database version
	Sirius satellite radio ESN
	Gracenote Database Information and Library version
Software Licenses	View the licenses for any software and applications installed on your system.
Driving Restrictions	Certain features are not accessible when your vehicle is moving.
911 Assist	Turn on and turn off the 911 Assist feature. See <b>Information</b> (page 419). <b>In Case of Emergency (ICE) Quick Dial:</b> allows you to save up to two numbers as ICE contacts for quick access if there is an emergency. Select <b>Edit</b> to access your phonebook and then select the desired contacts. The numbers then appear as options on this screen for the ICE 1 and ICE 2 buttons. The ICE contacts you select appear at the end of the 911 Assist call process.
Voice Command List	View categorized lists of voice commands.

# MyLincoln Touch™

To access Help using the voice commands, press the voice button, then, after the tone,

say "Help". The system provides allowable voice commands for the current mode.

## ENTERTAINMENT

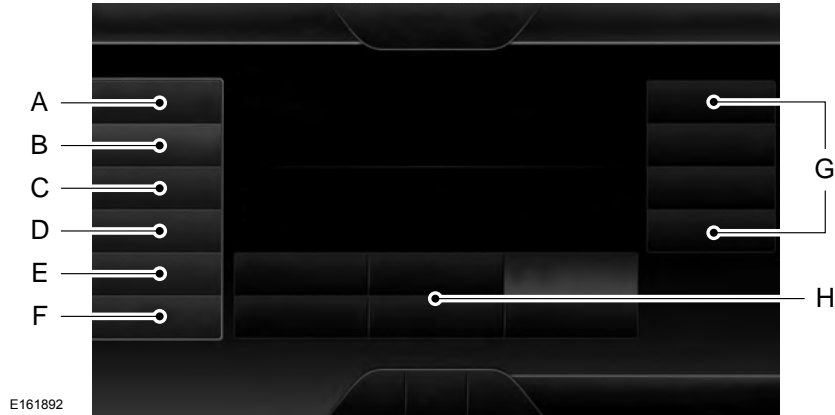

- A AM 1 and AM AST
- B FM 1, FM 2 and FM AST
- C SIRIUS

# MyLincoln Touch™

- D CD
- E USB
- F Touch this button to scroll down for more options, such as SD Card, BT Stereo and A/V In
- G These buttons change with the media mode you are in.
- H Radio memory presets and CD controls.

**Note:** Some features may not be available in your area. Contact an authorized dealer for more information.

You can access these options using the touchscreen or voice commands.

## Browsing Device Content

When listening to audio on a device, you can browse through other devices without having to change sources. For example, if you are currently listening to audio on an SD card, you can browse all the artists that are stored on your USB device.



Press the voice icon on the steering wheel. When prompted, you can say:

" <b>BROWSE</b> " within devices
"Browse"
"Browse <league> games"
"Browse <Sirius category> channels"
"Browse SD card"
"Browse Sirius channel guide"

" <b>BROWSE</b> " within devices
"Browse USB"
"Help"

If you only say, "Browse", you can then say any commands in the following chart.

This command is only usable if you have an active subscription to Sirius satellite radio.

" <b>BROWSE</b> "
"<League> Games"
"<Sirius category> channels"
"SD card"

# MyLincoln Touch™

<b>"BROWSE"</b>
"Sirius Channel Guide"
"USB"
"Help"

This command is only usable if you have an active subscription to Sirius satellite radio.

For more commands in SD card or USB mode, see the "SD Card and USB Port" section of this chapter.

Your voice system allows you to change audio sources with a simple voice command. For example, if you are listening to music on a USB device, then want to switch to a satellite radio channel, simply press the voice button on the steering wheel controls and say the name of the Sirius station (such as, "the Highway"). The following voice commands are available at the top level of the voice session no matter which current audio source you are listening to (such as a USB device or Sirius satellite radio).

**Note:** *This is only available when your MyLincoln Touch system language is set to North American English.*

Sample commands
"<87.9-107.9>"
"<530-1710>"
"<Channel name>".
"AM <530-1710>"
"FM <87.9-107.9>"
"Play [album] <name>".
"Play [artist] <name>".
"Play [genre] <name>".
"Play [playlist] <name>".
"Play [song] <name>".
"Play <name>"

Sample commands
"Play <name (song or album)> by <artist name>"
"Sirius <0-223>".
"Sports games".

This command is only usable if you have an active subscription to Sirius satellite radio.

The commands that have [ ] around the word means that the word is optional. For example, if you say, "Play Metallica", this is the same as the voice command, "Play [artist] <name>".

## AM/FM Radio



Touch the **AM** or **FM** tab to listen to the radio.

To change between AM and FM presets, just touch the **AM** or **FM** tab.

## Memory Presets

Save a station by pressing and holding one of the memory preset areas. There is a brief mute while the radio saves the station. Sound returns when finished.

## HD Radio

Touch this button to turn HD Radio on. The light on the button illuminates when the feature is on. HD Radio allows you to receive radio broadcasts digitally, where available, providing free, crystal-clear sound. See HD Radio information later in this chapter.

## Scan

Touch this button to go to the next strong AM or FM radio station. The light on the button illuminates when the feature is on.

## Options

### Sound Settings

Touch this button to adjust settings for:

- Bass
- Midrange

- Treble
- Balance and Fade
- THX Deep Note Demo
- DSP (Digital Signal processing)
- Occupancy Mode
- Speed Compensated Volume.

**Note:** *Your vehicle may not have all these sound settings.*

### Set PTY for Seek/Scan

This allows you to select a category of music you would like to search for. You can then choose to either seek or scan for the stations playing that category.

### RDS Text Display

This allows you to view the information broadcast by FM stations.

### AST

AST (Autostore) allows you to have the system automatically store the six strongest stations in your current location.

## TAG Button

This feature is available when HD Radio is on, and allows you to tag a song to download later. When you select On, **TAG** appears on-screen when HD Radio is active. You can touch **TAG** to save the information of the song that is playing. When you plug in your portable music player, the information transfers, if supported by your device. When you are connected to iTunes®, the tags appear to remind you of the songs you would like to download. See HD Radio information later in this chapter.

## Direct Tune

Touch this button to enter the desired station number manually. Touch **Enter** when you are done.

## HD Radio™ Information (If Available)

**Note:** *HD Radio broadcasts are not available in all markets.*

HD Radio technology is the digital evolution of analog AM/FM radio. Your system has a special receiver that allows it to receive digital broadcasts (where available) in addition to the analog broadcasts, it already receives. Digital broadcasts provide a better sound quality than analog broadcasts with free, crystal-clear audio and no static or distortion. For more information, and a guide to available stations and programming, please visit [www.hdradio.com](http://www.hdradio.com).

When HD Radio is on and you tune to a station broadcasting HD Radio technology, you may notice the following indicators on your screen:



E142616

The HD Radio logo either blinks when acquiring a digital station, and then stays solid when digital audio is playing, or is grey when acquiring a digital station, and then changes to orange when digital audio is playing. When this logo is available, you may also see Title and Artist fields on-screen.

The multicast indicator appears in FM mode (only) if the current station is broadcasting multiple digital broadcasts. The highlighted numbers signify available digital channels where new or different content is available. HD1 signifies the main programming status and is available in analog and digital broadcasts. Other multicast stations (HD2 through HD7) are only available digitally.

**TAG** allows you to save a song to download later when you are on an acquired HD Radio station and the feature is on. To turn the feature on and use it:

1. Press **AM** or **FM** > **Options** > **TAG Button** > **On**.
2. When you hear a song you like, touch **TAG**.
3. The system automatically saves the song's information and transfers it to your portable music player (if supported) when you connect it to the system. The system automatically transfers the tag to your player (if already connected) and a pop-up confirms the transfer.
4. When you access iTunes with your portable music player, the tags appear to you as a reminder. The system allows you to tag up to approximately 100 songs. For a list of devices that support tagging, see [www.SYNCMYRide.com](http://www.SYNCMYRide.com), [www.SYNCMYRide.ca](http://www.SYNCMYRide.ca) or [www.syncmaroute.ca](http://www.syncmaroute.ca).

# MyLincoln Touch™

When HD Radio broadcasts are active, you can access the following functions:

- **Scan** allows you to hear a brief sampling of all available stations. This feature still works when HD Radio reception is on, although it does not scan for HD2-HD7 channels. You may see the HD logo appear if the station has a digital broadcast.

- **Memory presets** allow you to save an active channel as a memory preset. Touch and hold a memory preset slot until the sound returns. There is a brief mute while the radio saves the station. Sound returns when finished. When switching to an HD2 or HD3 memory preset, the sound mutes before the digital audio plays, because the system has to reacquire the digital signal.

**Note:** *As with any saved radio station, you cannot access the saved station if your vehicle is outside the station's reception area.*

## **HD Radio Reception and Station Troubleshooting**

<b>Potential reception issues</b>	
Reception area	If you are listening to a multicast station and you are on the fringe of the reception area, the station may mute due to weak signal strength.
	If you are listening to HD1, the system switches back to the analog broadcast until the digital broadcast is available again. However, if you are listening to any of the possible HD2-HD7 multicast channels, the station mutes and stays muted unless it is able to connect to the digital signal again.
Station blending	When the system first receives a station (aside from HD2-HD7 multicast stations), it first plays the station in the analog version. Once the receiver verifies the station is an HD Radio station, it shifts to the digital version. Depending on the station quality, you may hear a slight sound change when the station changes from analog to digital. Blending is the shift from analog to digital sound or digital back to analog sound.

# MyLincoln Touch™

In order to provide the best possible experience, use the contact form to report any station issues found while listening to a station broadcasting with HD Radio

technology. Independent entities own and operate each station. These stations are responsible for ensuring all audio streams and data fields are accurate.

Potential station issues		
Issues	Cause	Action
Echo, stutter, skip or repeat in audio. Increase or decrease in audio volume.	This is poor time alignment by the radio broadcaster.	No action required. This is a broadcast issue.
Sound fading or blending in and out.	The radio is shifting between analog and digital audio.	No action required. The reception issue may clear up as you continue to drive.
There is an audio mute delay when selecting HD2 or HD3, multicast preset or <b>Direct Tune</b> .	The digital multicast is not available until the HD Radio broadcast is decoded. Once decoded, the audio is available.	No action required. This is normal behavior. Wait until the audio is available.
Cannot access HD2 or HD3 multicast channel when recalling a preset or from a direct tune.	The previously stored multicast preset or direct tune is not available in your current reception area.	No action required. The station is not available in your current location.
Text information does not match currently playing audio.	Data service issue by the radio broadcaster.	Fill out the station issue form at website listed below.

# MyLincoln Touch™

Potential station issues		
Issues	Cause	Action
There is no text information shown for currently selected frequency.	Data service issue by the radio broadcaster.	Fill out the station issue form at website listed below.
HD2-HD7 stations not found when <b>Scan</b> is pressed.	Pressing <b>Scan</b> disables HD2-HD7 channel search.	No action required. This is normal behavior.

[http://www.ibiquity.com/automotive/report\\_radio\\_station\\_experiences](http://www.ibiquity.com/automotive/report_radio_station_experiences)

HD Radio Technology manufactured under license from iBiquity Digital Corp. U.S. and foreign patents. HD Radio and the HD and HD Radio logos are proprietary trademarks of iBiquity Digital Corp. Ford Motor Company and iBiquity Digital Corp. are not responsible for the content sent using HD Radio technology. Content may be changed, added or deleted at any time at the station owner's discretion.

## Radio Voice Commands



If you are listening to the radio, press the voice button on the steering wheel controls. When prompted, say any of the following commands.

If you are not listening to the radio, press the voice button and, after the tone, say "Radio", then any of the following commands.

" <b>RADIO</b> "
"<87.9-107.9>"
"<87.9-107.9> HD" <sup>1</sup>
"<530-1710>"
"AM"
"AM <530-1710>"
"AM autoselect"
"AM autoselect preset <#>"
"AM preset <#>"

# MyLincoln Touch™

<b>"RADIO"</b>
"Browse" <sup>2</sup>
"FM"
"FM <87.9-107.9>"
"FM <87.9-107.9> HD <#>" <sup>1</sup>
"FM autosest"
"FM autosest preset <#>"
"FM preset <#>"
"FM 1"
"FM 1 preset <#>"
"FM 2"
"FM 2 preset <#>"
"HD <#>" <sup>1</sup>
"Preset <#>"
"Radio off"
"Radio on"

<b>"RADIO"</b>
"Set PTY"
"Tune" <sup>3</sup>
"Help"

<sup>1</sup> If available.

<sup>2</sup> If you have said "Browse", see the "Browse" chart later in this section.

<sup>3</sup> If you have said "Tune", see the following "Tune" chart.

<b>"TUNE"</b>
"<530-1710>"
"<87.9-107.9>"
"<87.9-107.9> HD <#>" <sup>1</sup>
"AM"
"AM <530-1710>"
"AM autosest"

<b>"TUNE"</b>
"AM autosest preset <#>"
"AM preset <#>"
"FM"
"FM <87.9-107.9>"
"FM <87.9-107.9> HD <#>" <sup>1</sup>
"FM autosest"
"FM autosest preset <#>"
"FM preset <#>"
"FM 1"
"FM 1 preset <#>"
"FM 2"
"FM 2 preset <#>"
"HD <#>" <sup>1</sup>

# MyLincoln Touch™

"TUNE"
"Preset <#>"
"Help"

If available.

## Sirius® Satellite Radio (If Activated)



Press the lower left corner of the touchscreen, and then select the **SIRIUS** tab.

## Memory Presets

Save a channel by pressing and holding one of the memory preset areas. There is a brief mute while the radio saves the channel. Sound returns when finished.

## ALERT

Save the current song, artist, or team as a favorite. The system alerts you when it plays again on any channel.

## Replay

Replay audio on the current channel. You can replay approximately 45 minutes of audio as long as you have remained tuned to the current station. Changing stations erases the previous audio.

While in replay mode:

- Press and release the seek buttons to hear the previous or next song.
- Press and hold the seek buttons to reverse or fast forward in the current track.
- Press play or pause to play or pause the audio.
- Press **Replay** to return to live audio if you have been using the feature to replay audio.

## Scan

Touch this button to hear a brief sampling of channels.

## Options

Touch this button to view and adjust various media settings.

## Sound Settings

Touch this button to adjust settings for:

- Bass
- Midrange
- Treble
- Balance and Fade
- THX Deep Note Demo
- DSP (Digital Signal processing)
- Occupancy Mode
- Speed Compensated Volume.

**Note:** *Your vehicle may not have all these sound settings.*

## Set Category for Seek/Scan

This allows you to select a category of music you would like to search for. You can then choose to either seek or scan for the stations playing that category.

## Parental Lockout

This allows you to lock and unlock channels, change or reset your PIN or unlock all channels. To use this feature, you need your initial PIN, which is 1234.

## Artist/Title/Team Alerts

This feature allows you to select Artists, Titles and Teams that you would like the system to alert you to when they are playing on other channels. Press Edit Alerts to delete or turn off alerts. You can also set all alerts to on or off. When an alert appears on the screen, you can choose to Tune to the channel, to Cancel the alert or to Disable Alerts. If you are listening to a sporting event, you can save your favorite teams so that the system can alert you when they are playing on a satellite radio channel.

**Note:** *Sirius does not support the Alert feature on all channels. Ford Motor Company shall not be responsible for Alert feature variation.*

## Electronic Serial Number (ESN)

Sirius requires this number when communicating with you about your account.

## Direct Tune

Touch this button to enter the desired satellite channel number manually. Touch **Enter** when you are done.

## Browse

Touch this button to view a list of all available stations. Scroll to see more categories. Touch the station you want to listen to.

Touch **Skip** if you want to skip this channel.

Touch **Lock** if you do not want anyone to listen to this channel.

Touch **Title** or **Artist** to see song and artists on other stations.

## Sirius Satellite Radio Information

**Note:** *Sirius reserves the unrestricted right to change, rearrange, add or delete programming including canceling, moving or adding particular channels, and its prices, at any time, with or without notice to you. Ford Motor Company shall not be responsible for any such programming changes.*



E142593

Sirius satellite radio is a subscription-based satellite radio service that broadcasts a variety of music, sports, news, weather, traffic and entertainment programming. Your factory-installed Sirius satellite radio system includes hardware and a limited subscription term that begins on the date of sale or lease of your vehicle. See an authorized dealer for availability.

For more information on extended subscription terms (a service fee is required), the online media player and a list of Sirius satellite radio channels, and other features, please visit [www.siriusxm.com](http://www.siriusxm.com) in the United States, [www.sirius.ca](http://www.sirius.ca) in Canada, or call Sirius at 1-888-539-7474.

**Note:** *This receiver includes the eCos real-time operating system. eCos is published under the eCos License.*

# MyLincoln Touch™

## **Satellite Radio Electronic Serial Number (ESN)**

You need your ESN to activate, modify or track your satellite radio account. The ESN

is on the System Information Screen (SR ESN:XXXXXXXXXXXX). To access your ESN, touch the bottom left corner of the touchscreen. Touch **SIRIUS > Options**.

## **Sirius Satellite Radio Reception Factors and Troubleshooting**

<b>Potential reception issues</b>	
Antenna obstructions	For optimal reception performance, keep the antenna clear of snow and ice build-up and keep luggage and other materials as far away from the antenna as possible.
Terrain	Hills, mountains, tall buildings, bridges, tunnels, freeway overpasses, parking garages, dense tree foliage and thunderstorms can interfere with your reception.
Station overload	When you pass a ground-based broadcast-repeating tower, a stronger signal may overtake a weaker one and the audio system may mute.
Satellite radio signal interference	Your display may show ACQUIRING... to indicate the interference and the audio system may mute.

# MyLincoln Touch™

<b>Troubleshooting tips</b>		
<b>Radio display</b>	<b>Cause</b>	<b>Action</b>
Acquiring...	Radio requires more than two seconds to produce audio for the selected channel.	No action required. This message should disappear shortly.
Sat Fault/Sirius System Failure.	There is an internal module or system failure present.	If this message does not clear shortly, or with an ignition key cycle, your receiver may have a fault. See an authorized dealer for service.
Invalid Channel.	The channel is no longer available.	Tune to another channel or choose another preset.
Unsubscribed Channel.	Your subscription does not include this channel.	Contact Sirius at 1-888-539-7474 to subscribe to the channel, or tune to another channel.
No Signal.	The signal is lost from the Sirius satellite or Sirius tower to your vehicle antenna.	The signal is blocked. When you move into an open area, the signal should return.
Updating.	Update of channel programming in progress.	No action required. The process may take up to three minutes.

# MyLincoln Touch™

Troubleshooting tips		
Radio display	Cause	Action
Call Sirius 1-888-539-7474.	Your satellite service is no longer available.	Contact Sirius at 1-888-539-7474 to resolve subscription issues.
None found. Check Channel Guide.	All the channels in the selected category are either skipped or locked.	Use the channel guide to turn off the Lock or Skip function on that station.
Subscription Updated.	Sirius has updated the channels available for your vehicle.	No action required.

## Sirius Satellite Radio Voice Commands



If you are listening to Sirius satellite radio, press the voice button on the steering wheel controls. When prompted, say any of the following commands.

If you are not listening to Sirius satellite radio, press the voice button and, after the tone, say "Sirius", then any of the following commands.

"SIRIUS"
"<Channel name>"
"Preset <#>"
"SAT"
"SAT preset <#>"
"SAT 1"
"SAT 1 Preset <#>"
"SAT 2"
"SAT 2 preset <#>"

"SIRIUS"
"SAT 3"
"SAT 3 preset <#>"
"Sirius <0-223>"
"Sirius off"
"Sirius on"
"Sports game"

<b>"SIRIUS"</b>
"Tune"
"Help"

If you have said "Sports game", see the following "Sports game" chart.

If you have said "Tune", see the following "Tune" chart.

<b>"SPORTS GAME"</b>
"Tune to the <college name> game"
"Tune to the <team city> game"
"Tune to the <team city> <team name> game"
"Tune to the <team name> game"
"Help"

<b>"TUNE"</b>
"<Channel Name>"
"Preset <#>"
"SAT"
"SAT 1"
"SAT 1 preset <#>"
"SAT 2"
"SAT 2 preset <#>"
"SAT 3"
"SAT 3 preset <#>"
"Sirius <0-223>"
"Help"

## CD



Press the lower left corner of the touchscreen, and then select the **CD** tab.

You can also advance and reverse the current track or current folder, if applicable.

## Repeat

Touch this button to repeat the currently playing track, all tracks on the disc or turn the feature off if already on.

## Shuffle

Touch this button to play the tracks or entire albums in random order, or turn the feature off if already on.

## Scan

Touch this button to hear a brief sampling of all available tracks.

## More Info

Touch this button to see disc information.

## Options

### Sound Settings

Touch this button to adjust settings for:

# MyLincoln Touch™

- Bass
- Midrange
- Treble
- Balance and Fade
- THX Deep Note Demo
- DSP (Digital Signal processing)
- Occupancy Mode
- Speed Compensated Volume.

**Note:** Your vehicle may not have all these sound settings.

## Compression

Touch this button to turn the compression feature off and on.

## Browse

Touch this button to look through all available CD tracks.

## CD Voice Commands



If you are listening to a CD, press the voice button on the steering wheel controls. When prompted, say any of the following commands.

If you are not listening to a CD, press the voice button and, after the tone, say "CD", then any of the following commands.

"CD"
"Pause"
"Play"
"Play next track"
"Play previous track"
"Play track <1-512>"
"Repeat"
"Repeat folder"
"Repeat off"
"Repeat track"
"Shuffle"
"Shuffle CD"
"Shuffle folder"

"CD"
"Shuffle off"
"Help"

This applies to WMA or MP3 files only.

## SD Card Slot and USB Port

### SD Card

**Note:** Your SD card slot is spring-loaded. To remove the SD card, press the card in and the system ejects it. Do not attempt to pull the card to remove it as this could cause damage.

**Note:** The navigation system also uses this card slot. See **Navigation** (page 435).

# MyLincoln Touch™

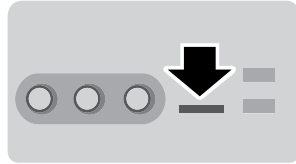

E142619

The SD card slot is located either in the center console or behind a small access door in the instrument panel. To access and play music from your device, press the lower left corner of the touchscreen.

SD



E142620

logo is a trademark of SD-3C, LLC.

## USB Port

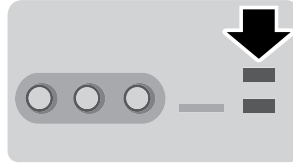

E142621

The USB ports are located either in the center console or behind a small access door in the instrument panel. To access and play music from your device, press the lower left corner of the touchscreen.

This feature allows you to plug in media playing devices, memory sticks, flash drives or thumb drives, and charge devices if they support this feature.

In order to playback video from your iPod or iPhone, you must have a special combination USB/RCA composite video cable (which you can buy from Apple). When you connect the cable to your iPod or iPhone, plug the other end into both the RCA jacks and the USB port.

## Playing Music from Your Device

**Note:** *The system is capable of indexing up to 30,000 songs.*



Insert your device and select the **SD Card** or **USB** tab once the system recognizes it. You can then select from the following options:

### Repeat

This feature replays the currently playing song or album.

### Shuffle

Touch this button to play music on the selected album or folder in random order.

# MyLincoln Touch™

## Similar Music

This feature allows you to choose music similar to what is currently playing.

## More Info

Touch this button to see disc information such as current track, artist name, album and genre.

## Options

Touch this button to view and adjust various media settings.

**Sound Settings** allows you to adjust settings for:

- Bass
- Midrange
- Treble
- Balance and Fade
- THX Deep Note Demo
- DSP (Digital Signal processing)
- Occupancy Mode
- Speed Compensated Volume.

**Note:** *Your vehicle may not have all these sound settings.*

**Media Player Settings** allows you to select more settings, which is under Media Player. See **Settings** (page 372).

**Device Information** displays software and firmware information about the currently connected media device.

**Update Media Index** indexes your device when you connect it for the first time and each time the content changes (such as adding or removing tracks) to make sure you have the latest voice commands available for all media on the device.

## Browse

This feature allows you to view the contents of the device. It also allows you to search by categories, such as genre, artist or album.

If you want to view song information such as Title, Artist, File, Folder, Album, and Genre, touch the on-screen album art.

You can also touch **What's Playing** to hear how the system pronounces the current band and song. This can be helpful when using voice commands to make sure the system correctly plays your request.

## Playing Video from Your Device

To access and play video from your device, your vehicle's transmission must be in position **P** with the ignition in accessory mode. See **Starting and Stopping the Engine** (page 163).

## SD Card and USB Voice Commands



If you are listening to a USB device or an SD card, press the voice button on the steering wheel controls. When prompted, say any of the following commands.

If you are not listening to a USB device or an SD card, press the voice button and, after the tone, say "USB" or "SD card", then any of the following commands.

# MyLincoln Touch™

"USB" or "SD CARD"
"Browse"
"Next"
"Pause"
"Play"
"Play album <name>"
"Play all"
"Play artist <name>"
"Play audiobook <name>"
"Play author <name>"
"Play composer <name>"
"Play folder <name>"
"Play genre <name>"
"Play movie <name>" <sup>**</sup>
"Play music video <name>" <sup>**</sup>

"USB" or "SD CARD"
"Play playlist <name>"
"Play podcast <name>"
"Play podcast episode <name>"
"Play similar music"
"Play song <name>"
"Play TV show <name>" <sup>**</sup>
"Play TV show episode <name>" <sup>**</sup>
"Play video <name>" <sup>**</sup>
"Play video podcast <name>" <sup>**</sup>
"Play video podcast episode <name>" <sup>**</sup>
"Play video playlist <name>" <sup>**</sup>
"Previous"
"Repeat all"
"Repeat off"

"USB" or "SD CARD"
"Repeat one"
"Shuffle"
"Shuffle album"
"Shuffle off"
"What's this?"
"Help"

If you have said you would like to browse your USB or SD card, the system prompts you to specify what you would like to browse. When prompted, see the following "Browse" chart.

<sup>\*\*</sup> These commands are only available in USB mode and are device-dependent.

"BROWSE"
"Album <name>"
"All albums"
"All artists"

# MyLincoln Touch™

"BROWSE"
"All audiobooks"
"All authors"
"All composers"
"All folders"
"All genres"
"All movies"
"All music videos"
"All playlists"
"All podcasts"
"All songs"
"All TV shows"
"All video playlists"
"All video podcasts"
"All videos"

"BROWSE"
"Artist <name>"
"Audiobook <name>"
"Author <name>"
"Composer <name>"
"Folder <name>"
"Genre <name>"
"Playlist <name>"
"Podcast <name>"
"TV show <name>"
"Video <name>"
"Video playlist <name>"
"Video podcast <name>"
"Help"

This command is only available in USB mode and is device-dependent.

## Supported Media Players, Formats and Metadata Information

SYNC is capable of hosting nearly any digital media player, including iPod, Zune™, plays from device players, and most USB drives. Supported audio formats include MP3, WMA, WAV and AAC.

It is also able to organize your indexed media from your playing device by metadata tags. Metadata tags, which are descriptive software identifiers embedded in the media files, provide information about the file.

If your indexed media files contain no information embedded in these metadata tags, SYNC may classify the empty metadata tags as **Unknown**.

In order to playback video from your iPod or iPhone, you must have a special combination USB/RCA composite video cable (which you can buy from Apple). When you connect the cable to your iPod or iPhone, plug the other end into both the RCA jacks and the USB port.

## Bluetooth Audio

Your system allows you to stream audio over your vehicle's speakers from your connected, Bluetooth-enabled cellular phone.



To access, press the lower left corner on the touchscreen, then select the **BT Stereo** tab.

## Bluetooth Audio Voice Commands



If you are listening to a Bluetooth audio device, press the voice button on the steering wheel control. When prompted, say "Next song", "Pause", "Play" or "Previous song".

If you are not listening to a Bluetooth audio device, press the voice button and, after the tone, say "Next song", "Pause", "Play" or "Previous song".

## A/V Inputs

### WARNINGS



Driving while distracted can result in loss of vehicle control, crash and injury. We strongly recommend that you use extreme caution when using any device that may take your focus off the road. Your primary responsibility is the safe operation of your vehicle. We recommend against the use of any handheld device while driving and encourage the use of voice-operated systems when possible. Make sure you are aware of all applicable local laws that may affect the use of electronic devices while driving.



For safety reasons, do not connect or adjust the settings on your portable music player while your vehicle is moving.

### WARNINGS



Store the portable music player in a secure location, such as the center console or the glove box, when your vehicle is moving. Hard objects may become projectiles in a crash or sudden stop, which may increase the risk of serious injury. The audio extension cable must be long enough to allow the portable music player to be safely stored while your vehicle is moving.

# MyLincoln Touch™

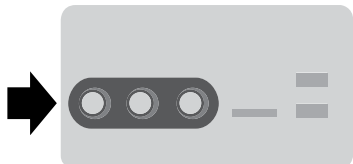

E142622

Your A/V inputs allow you to connect an auxiliary audio/video source (such as a gaming systems or a personal camcorder) by connecting RCA cords (not included) to these input jacks. The jacks are yellow, red and white and are located either behind a small access door on the instrument panel or in your center console.

You can also use the A/V inputs as an auxiliary input jack to play music from your portable music player over your vehicle's speakers. Plug in your 1/8 inch (3.5 millimeter) RCA adapter into the two left A/V input jacks (red and white).

Press the lower left corner of the touchscreen, and then select **A/V In**.

To use the auxiliary input jack feature, make sure that your portable music player is designed for use with headphones and that it is fully charged. You also need an audio extension cable with stereo male 1/8-inch (3.5 millimeter) connectors at one end and a RCA jack at the other.

1. Switch off the engine, radio and portable music player. Set the parking brake and put the transmission in position **P**.
2. Attach one end of the audio extension cable to the headphone output of your player and the other end into the adapter in one of the two left A/V input jacks (white or red) inside the center console.
3. Press the lower left corner on the touchscreen. Select either a tuned FM station or a CD (if there is a CD already loaded into the system).
4. Adjust the volume as desired.
5. Turn the portable music player on and adjust the volume to ½ the maximum.
6. Press the lower left corner on the touchscreen. Select the **A/V In** tab. (You should hear audio from your portable music player although it may be low.)

7. Adjust the sound on your portable music player until it reaches the level of the FM station or CD by switching back and forth between the controls.

In order to playback video from your iPod or iPhone, you must have a special combination USB/RCA composite video cable (which you can buy from Apple). When you connect the cable to your iPod or iPhone, plug the other end into both the RCA jacks and the USB port.

## Troubleshooting

- Do not connect the audio input jack to a line level output. The jack only works correctly with devices that have a headphone output with a volume control.
- Do not set the portable music player's volume level higher than is necessary to match the volume of the CD or FM radio as this causes distortion and reduces sound quality.

# MyLincoln Touch™

- If the music sounds distorted at lower listening levels, turn the portable music player volume down. If the problem persists, replace or recharge the batteries in the portable media player.
- Control the portable media player in the same manner when used with headphones, as the auxiliary input jack does not provide control (such as Play or Pause) over the attached portable media player.

## PHONE

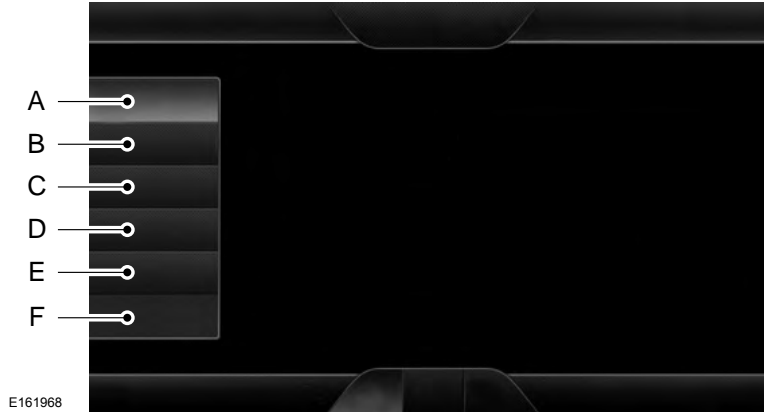

- A Phone
- B Quick Dial
- C Phonebook
- D History
- E Messaging
- F Settings

Hands-free calling is one of the main features of SYNC. Once you pair your phone, you can access many options using the touchscreen or voice commands. While the system supports a variety of features, many are dependent on your cellular phone's functionality.

At a minimum, most cellular phones with Bluetooth wireless technology support the following functions:

- Answering an incoming call.
- Ending a call.
- Using privacy mode.
- Dialing a number.
- Redialing.

- Call waiting notification.
- Caller ID.

Other features, such as text messaging using Bluetooth and automatic phonebook download, are phone-dependent features. To check your phone's compatibility, see your device's manual and visit [www.SYNCMYRide.com](http://www.SYNCMYRide.com), [www.SYNCMYRide.ca](http://www.SYNCMYRide.ca) or [www.syncmaroute.ca](http://www.syncmaroute.ca).

## Pairing Your Phone for the First Time

### WARNING



Driving while distracted can result in loss of vehicle control, crash and injury. We strongly recommend that you use extreme caution when using any device that may take your focus off the road. Your primary responsibility is the safe operation of your vehicle. We recommend against the use of any hand-held device while driving and encourage the use of voice-operated systems when possible. Make sure you are aware of all applicable local laws that may affect the use of electronic devices while driving

---

# MyLincoln Touch™

The first thing you must do to use the phone features of SYNC is to pair your Bluetooth-enabled cellular phone with SYNC. This allows you to use your phone in a hands-free manner.

**Note:** Put the transmission in park (P). Switch on your vehicle ignition and the radio.

1. Touch **Add Phone** in the upper left corner of the touchscreen. **Find SYNC** appears on the screen, and instructs you to begin the pairing process from your device.
2. Make sure that Bluetooth is set to **On** and that your cellular phone is in the proper mode. See your device's manual if necessary.

**Note:** Select **SYNC**, and a six-digit PIN appears on your device.

3. If prompted to enter a PIN on your device, it does not support Secure Simple Pairing. To pair, enter the PIN displayed on the touchscreen. Skip the next step.

4. When prompted on your phone's display, confirm that the PIN provided by SYNC matches the PIN displayed on your cellular phone.
5. The display indicates when the pairing is successful.

SYNC may prompt you with more phone options. For more information on your phone's capability, see your device's manual and visit the website.

## Pairing Subsequent Phones

**Note:** Put the transmission in park (P). Switch on your vehicle ignition and the radio.

1. Press the **Phone** corner of the touchscreen > **Settings** > **BT Devices** > **Add Device**.
2. Make sure that Bluetooth is set to **On** and that your cellular phone is in the proper mode. See your device's manual if necessary.

**Note:** Select **SYNC**, and a six-digit PIN appears on your device.

3. If prompted to enter a PIN on your device, it does not support Secure Simple Pairing. To pair, enter the PIN displayed on the touchscreen. Skip the next step.
4. When prompted on your phone's display, confirm that the PIN provided by SYNC matches the PIN displayed on your cellular phone.
5. The display indicates when the pairing is successful.

SYNC may prompt you with more phone options. For more information on your phone's capability, see your device's manual and visit the website.

## Making Calls



Press the voice button on your steering wheel controls. When prompted, say, "Call <name>" or say "Dial", then the desired number.



To end the call or exit phone mode, press and hold this phone button on your steering wheel controls.

## Receiving Calls

During an incoming call, an audible tone sounds. Call information appears in the display if it is available.



Accept the call by pressing **Accept** on the touchscreen or by pressing this phone button on your steering wheel controls.



Reject the call by pressing **Reject** on the touchscreen or by pressing and holding this phone button on your steering wheel controls.

Ignore the call by doing nothing. SYNC logs it as a missed call.

## Phone Menu Options

Press the top left corner on your touchscreen to select from the following options:

## Phone

Touch this button to access the on-screen numerical pad to enter a number and place a call. During an active call, you can also choose to:

- Mute the call.
- Put the call on hold.
- Turn on the privacy feature.
- Join two calls.
- End the call.

## Quick Dial

Set up favorite contacts from your phonebook or history folder.

## Phonebook

Touch this button to access and call any contacts in your previously downloaded phone book. The system places the entries in alphabetical categories summarized at the top of the screen.

To switch on contact picture settings, if your device supports this feature, press **Phone > Settings > Manage Phonebook > Download photos from Phonebook > On**.

## History

After you connect your Bluetooth-enabled phone to SYNC, you can access any previously dialed, received or missed calls. You can also choose to save these to your Favorites or to Quick Dial.

**Note:** *This is a phone-dependent feature. If your phone does not support downloading call history using Bluetooth, SYNC keeps track of calls made with the SYNC system.*

## Messaging

Send text messages using your touchscreen. See **Text messaging** later in this section.

## Settings

Touch this button to access various phone settings, such as turning Bluetooth on and off, managing your phonebook and more. See **Phone settings** later in this section.

## Text Messaging

**Note:** Downloading and sending text messages using Bluetooth are phone-dependent features.

**Note:** Certain features in text messaging are speed-dependent and not available when your vehicle is traveling at speeds over 3 mph (5 km/h).

**Note:** SYNC does not download read text messages from your phone.

You can send and receive text messages using Bluetooth, read them aloud and translate text messaging acronyms, such as LOL.

1. Touch the top left corner of the display to access the **Phone** menu.
2. Select **Messaging**.
3. Choose from the following:
  - Listen (speaker icon).
  - Dial.
  - Send Text.
  - View.
  - Delete.

## Composing a Text Message

**Note:** This is a speed-dependent feature. It is unavailable when your vehicle is traveling at speeds over 3 mph (5 km/h).

**Note:** Downloading and sending text messages using Bluetooth are phone-dependent features.

1. Touch the top left corner of the display to access the **Phone** menu.
2. Touch **Messaging > Send Text**.
3. Enter a phone number or choose from your phonebook.
4. You can select from the following options:
  - **Send**, which sends the message as it is.
  - **Edit Text**, which allows you to customize the pre-defined message or create a message on your own.

You can then preview the message, verify the recipient as well as update the message list.

Text message options
I'll call you back in a few minutes.
I just left, I'll be there soon.
Can you give me a call?
I'm on my way.
I'm running a few minutes late.
I'm ahead of schedule, so I'll be there early.
I'm outside.
I'll call you when I get there.
OK
Yes
No
Thanks
Stuck in traffic.
Call me later.
LOL

## Receiving a Text Message

**Note:** *If you select View and your vehicle is traveling over 3 mph (5 km/h), the system offers to read the message to you instead of allowing you to view it while driving.*

When a new message arrives, an audible tone sounds and the screen displays a pop-up with the caller name and ID, if supported by your phone. You can press:

- **View** to view the text message.
- **Listen** for SYNC to read the message to you.
- **Dial** to call the contact.
- **Ignore** to exit the screen.

## Phone Settings

Press **Phone > Settings**.

## Bluetooth Devices

Touch this tab to connect, disconnect, add or delete a device, as well as save it as a favorite.

## Bluetooth

Touch this tab to turn Bluetooth off or on.

## Do Not Disturb

Touch this tab if you want all calls to go directly to your voice mail and not ring in the vehicle. When this feature is on, text message notifications do not ring inside the cabin either.

## 911 Assist

Switch on or switch off the 911 Assist feature. See **Information** (page 419).

## Phone Ringer

Select the ring tone you want to hear when you receive a call. Choose from possible system ring tones, your currently paired phone's ring tone, a beep, text-to-speech or a silent notification.

## Text Message Notification

Select a text message notification, if supported by your phone. Choose from possible system alert tones, text-to-speech or silent.

## Internet Data Connection

If your phone is compatible, use this screen to adjust your internet data connection. Select to make your connection profile with the personal area network or to switch off your connection. You can also choose to adjust your settings or have the system always connect, never connect when roaming or query on connect. Press **?** for more information.

## Manage Phonebook

Touch this button to access features such as automatic phonebook download, re-download your phonebook, add contacts from your phone as well as delete or upload your phonebook.

## Roaming Warning

Touch this button to have the system alert you when your phone is in roaming mode.

## Phone Voice Commands



Press the voice button on the steering wheel controls. When prompted, say any of the following commands:

<b>"PHONE"</b>
"Call"
"Call <name>"
"Call <name> at home"
"Call <name> at work"
"Call <name> on cell"
"Call <name> on other"
"Call voicemail"
"Dial"
"Do not disturb off"

<b>"PHONE"</b>
"Do not disturb on"
"Forward text messages"
"Go to hands free"
"Hold call off"
"Hold on"
"Join calls"
"Listen to text message <#>"
"Listen to text messages"
"Messages"
"Mute call"
"Pair phone"
"Privacy on"
"Read text message"

<b>"PHONE"</b>
"Reply to text messages"
"Turn ringer off"
"Turn ringer on"
"Unmute call"
"Help"

This command is only available during an active call.

If you say "Messages", see the following "Messages" chart for additional commands.

<b>"MESSAGES"</b>
"Call"
"Forward text messages"
"Listen to text message <#>"
"Listen to text messages"
"Reply to text messages"
"Help"

# MyLincoln Touch™

## ELECTRIC VEHICLE INFORMATION



Your system has special electric vehicle screens, which display power flow and charge settings. To access these screens, press the EV Info button.



E163044

A Power

## Power

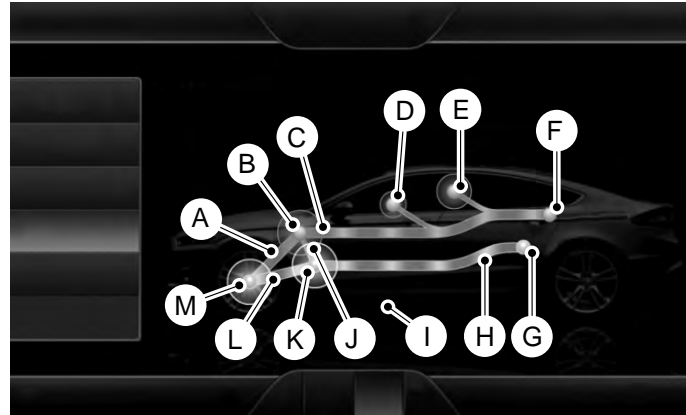

E163015

- A **Motor-to-wheel flow** shows the direction of power flow between the wheels and the electric motor.
- B **Electric Motor** represents the hybrid electric motor. The higher the motor power is, the larger the circle around this node. Any time the vehicle is ready to be driven, the motor node illuminates.
- C **Battery-to-motor flow** shows the direction of power flow between the high-voltage battery and the electric motor. Flow toward the motor indicates the battery is providing power to accelerate the vehicle (discharging the battery). Flow toward the battery indicates the electric motor is providing power to the battery (charging the battery).

# MyLincoln Touch™

---

- D **Other**<sup>2</sup> includes all power usage from the low voltage accessories such as the climate control fan, headlights and heated seats. The higher the power usage is from these accessories, the larger the circle around the node. This node illuminates anytime the vehicle is on since there is always some low level power in use.
- E **Climate**<sup>2,3</sup> includes the power usage from the high-voltage climate control components such as the electric A/C compressor. The higher the power usage is from these components, the larger the circle around this node.
- F **High voltage battery power** represents your high-voltage battery. A circle illuminates around the node when the high-voltage battery is receiving power from regenerative braking or engine charging. The higher the power going into the high-voltage battery, the larger the circle around this node.
- G **Fuel** represents the fuel tank in the vehicle.
- H **Fuel-to-engine flow** shows flow from the fuel tank to the engine when the engine is on and using fuel (there are some cases where the engine is on, but not using any fuel). When the engine is on, but not using fuel, the engine node is active, but the fuel flow path is off. An example of this is when your foot is off the accelerator pedal and the vehicle is traveling at a high speed.
- I **Engine On due to** provides you with the reason(s) the gasoline engine is on. When the gasoline engine is off, this display does not appear. **Engine On due to** reasons displayed by the system are in a chart following this list.
- J **Motor-to-engine flow** shows the direction of power flow between the engine and the electric motor. The direction indicates if the engine is providing power to the high-voltage electrical system, or if the high-voltage electrical system is providing power to control or start the engine.
- K **Engine power** represents the gasoline engine. It illuminates only when the gasoline engine is on. The higher the engine power is, the larger the circle around this node.
- L **Engine-to-wheels flow** shows the direction of the power flow between the engine and the wheels.
- M **Drive power** represents the power going to the wheels. The higher the wheel power is, the larger the circle around this node. When the engine is off, drive power is shown in blue. When the engine is on, drive power is shown in grey.

# MyLincoln Touch™

<sup>1</sup>The battery-to-motor flow includes battery power the vehicle is using for acceleration. It does not include energy the vehicle is using for accessories (such as air conditioning, headlights and radio). This screen displays accessories and climate usage separately.

<sup>2</sup>**Accessories** indicates electrical power demands from your vehicle's accessory systems. Accessories use power but do not contribute to making the vehicle move. The power flow displays power usage from the climate control system and other accessories separately.

<sup>3</sup>The climate control system may determine A/C is necessary even when you turn it off. In this case, you may see some climate power when the A/C is off.

Engine On due to	
Heater Setting	The engine is on because of the heater setting. Reduce or turn off the heater setting to return to electric mode.
High Speed	The engine is on because the vehicle speed exceeds the level for electric mode operation. Reduce the speed to return to electric mode.
Acceleration	The engine is on when applying pressure to the accelerator pedal or switching on the speed control. Reduce pressure on the accelerator pedal or switch off the speed control to return to full electric mode.
Neutral Gear	The engine is on because the vehicle is in neutral gear. Shift out of neutral gear to return to electric mode.

# MyLincoln Touch™

Engine On due to	
Low Gear	The engine is on because the vehicle is in low gear. Shift out of low gear to return to electric mode.
Battery Charging	The engine is on to charge the high-voltage battery. The vehicle returns to electric mode once the battery is charged.
Normal Operation	The engine is on to optimize vehicle operation. The vehicle returns to electric mode when possible.

## Status

This indicates which mode is active within the vehicle system.

### **Hybrid Drive**

The electric motor and gasoline engine are powering vehicle.

### **Charging HV Battery**

The hybrid system is storing power in the high-voltage battery.

### **Idle**

The vehicle is either at rest, or sharing very little power between the electric system parts.

### **Electric Drive**

The vehicle is driving in electric mode (the power is coming from the electric motor). The gasoline engine is off in this mode.

## INFORMATION

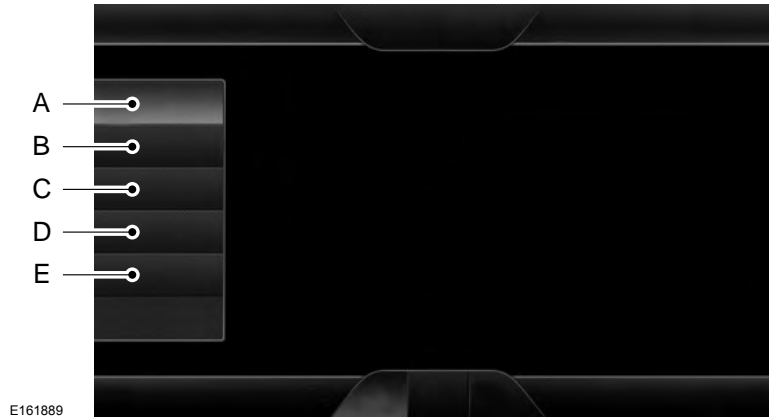

- A SYNC Services
- B Sirius Travel Link
- C Alerts
- D Calendar
- E SYNC Applications

Under the Information menu, you can access features such as:

- SYNC Services
- Sirius Travel Link
- Alerts
- Calendar
- SYNC Applications



If your vehicle is equipped with Navigation, press the **Information** button to access these features. If your vehicle is not equipped with Navigation, press the corner of the touchscreen with the green tab.

## **SYNC Services (If Equipped, United States Only)**

**Note:** SYNC Services varies by trim level and model year and may require a subscription. Traffic alerts and turn-by-turn directions available in select markets. Message and data rates may apply. Ford Motor Company reserves the right to change or discontinue this product service at any time without prior notification or incurring any future obligation.

**Note:** SYNC Services requires activation before use. Visit [www.SYNCMyRide.com](http://www.SYNCMyRide.com) to register and check your eligibility for complimentary services. Standard phone and message rates may apply. Subscription may be required. You must also have the active SYNC Services Bluetooth-enabled cellular phone paired and connected to the system in order to connect to, and use, SYNC Services. See **Phone** (page 407).

**Note:** This feature does not function properly if you have enabled caller ID blocking on your cellular phone. Make sure your cellular phone is not blocking caller ID before using SYNC Services.

**Note:** The driver is ultimately responsible for the safe operation of the vehicle, and therefore, must evaluate whether it is safe to follow the suggested directions. Any navigation features provided are only an aid. Make your driving decisions based on your observations of local conditions and existing traffic regulations. Do not follow the route suggestions if doing so would result in an unsafe or illegal maneuver, if you would be placed in an unsafe situation, or if you would be directed into an area that you consider unsafe. Maps used by this system may be inaccurate because of errors, changes in roads, traffic conditions or driving conditions.

**Note:** When you connect, the service uses GPS technology and advanced vehicle sensors to collect your vehicle's current location, travel direction and speed to help provide you with the directions, traffic reports, or business searches you request. Further, to provide the services you request, for continuous improvement, the service may collect and record call details and voice communications. For more information, see *SYNC Services Terms and Conditions* at [www.SYNCMyRide.com](http://www.SYNCMyRide.com). If you do not want Ford or its service providers to collect your vehicle travel information or other information identified in the *Terms and Conditions*, do not subscribe or use the service.

SYNC Services uses advanced vehicle sensors, integrated GPS technology and comprehensive map and traffic data, to give you personalized traffic reports, precise turn-by-turn directions, business search, news, sports, weather and more. For a complete list of services, or to learn more, please visit [www.SYNCMyRide.com](http://www.SYNCMyRide.com).

## Connecting to SYNC Services Using Voice Commands



1. Press the voice button.
2. When prompted, say "Services". This initiates an outgoing call to SYNC Services using your paired and connected Bluetooth-enabled cellular phone.
3. Once you connect to the service, follow the voice prompts to request the desired service, such as "Traffic" or "Directions". You can also say, "What are my choices?" to receive a list of available services from which to choose.
4. Say, "Services" to return to the Services main menu or for help, say, "Help".

## Connecting to SYNC Services Using the Touchscreen



If your vehicle is equipped with Navigation, press the **Information** button.

If your vehicle is not equipped with Navigation, press the green tab on your touchscreen.

1. Select **Connect to Services** to initiate an outgoing call to SYNC Services using your phone.
2. Once connected, follow the voice prompts to request your desired Service, such as "Traffic" or "Directions". You can also say, "What are my choices?" to receive a list of available services from which to choose.
3. Say, "Services" to return to the Services main menu or for help, say, "Help".

## Receiving Turn-by-Turn Directions

1. When connected to SYNC Services, say "Directions" or "Business search". To find the closest business or type of business to your current location, just say "Business search" and then "Search near me". If you need further assistance in finding a location you can say "Operator" at any time within a Directions or Business search to speak with a live operator. The system may prompt you to

Speak with an operator when it has difficulty matching your voice request.

The live operator can assist you by searching for businesses by name or by category, residential addresses by street address or by name or specific street intersections. Operator Assist is a feature of your SYNC Services subscription. For more information on Operator Assist, visit [www.SYNCMyRide.com/support](http://www.SYNCMyRide.com/support).

2. Follow the voice prompts to select your Destination. After the route download is finished, the phone call automatically ends.

If your vehicle is not equipped with Navigation:

- Turn-by-turn directions appear in the information display, in the status bar of your touchscreen system and on the SYNC Services screen. You also receive driving instructions from audible prompts.
- When on an active route, you can select **Route Summary** or **Route Status** using the touchscreen controls or voice commands to view the **Route Summary Turn List** or the **Route Status ETA**. You can also turn voice guidance on or off, cancel the route or update the route.

If you miss a turn, SYNC automatically asks if you want the route updated. Just say, "Yes" when prompted and the system delivers a new route to your vehicle.

If your vehicle is equipped with Navigation, SYNC Services downloads your requested destination to the navigation system. The navigation system then calculates the route and provides driving instructions. See **Navigation** (page 435).

### Disconnecting from SYNC Services

1. Press and hold the hang-up phone button on the steering wheel.
2. Say "Good-bye" from the SYNC Services main menu.

# MyLincoln Touch™

SYNC Services quick tips	
Personalizing	You can personalize your Services feature to provide quicker access to your most used or favorite information. You can save address points, such as work or home. You can also save favorite information like sports teams, such as Detroit Lions, or a news category. You can learn more about personalization by logging onto <a href="http://www.SYNCMyRide.com">www.SYNCMyRide.com</a> .
Push to interrupt	Press the voice button at any time (while connected to SYNC Services) to interrupt a voice prompt or an audio clip (such as a sports report) and say your voice command.
Portable	Your subscription is associated with your Bluetooth-enabled cellular phone number, not your VIN (Vehicle Identification Number). You can pair and connect your phone to any vehicle equipped with SYNC Services and continue enjoying your personalized services.

## SYNC Services Voice Commands



When a route has been downloaded (non-navigation systems), press the voice button on the steering wheel controls. When prompted, say any of the following commands:

"SERVICES"
"Cancel route"
"Navigation voice off"
"Navigation voice on"
"Next turn"
"Route status"
"Route summary"

"SERVICES"
"Services"
"Update route"
"Help"

# MyLincoln Touch™

## Sirius Travel Link (If Equipped)

### WARNING

 Driving while distracted can result in loss of vehicle control, crash and injury. We strongly recommend that you use extreme caution when using any device that may take your focus off the road. Your primary responsibility is the safe operation of your vehicle. We recommend against the use of any handheld device while driving and encourage the use of voice-operated systems when possible. Make sure you are aware of all applicable local laws that may affect the use of electronic devices while driving.

**Note:** *In order to use Sirius Travel Link, your vehicle must be equipped with navigation and your navigation SD card must be in the SD card slot.*

**Note:** *A paid subscription is required to access and use these features. Go to [www.siriusxm.com/travellink](http://www.siriusxm.com/travellink) for more information.*

**Note:** *Visit [www.siriusxm.com/traffic/#](http://www.siriusxm.com/traffic/#) and click on Coverage map and details for a complete listing of all traffic areas covered by Sirius Travel Link.*

**Note:** *Neither Sirius nor Ford is responsible for any errors or inaccuracies in the Sirius Travel Link services or its use in vehicles.*

When you subscribe to Sirius Travel Link, it can help you locate the best gas prices, find movie listings, get current traffic alerts, view the current weather map, get accurate ski conditions and see scores to current sports games.



If your vehicle is equipped with Navigation, touch the **i** (Information) button to access these features. If your vehicle is not equipped with Navigation, touch the corner of the touchscreen with the green tab.

## Traffic On Route and Traffic Nearby

Touch these buttons to identify traffic incidents on your route, nearby your vehicle's current location or near any of your favorite places, if programmed.

## Fuel Prices

Touch this button to view fuel prices at stations close to your vehicle's location or on an active navigation route.

## Movie Listings

Touch this button to view nearby movie theaters and their show times, if available.

## Weather

Touch this button to view the nearby weather, current weather, or the five day forecast for the chosen area. Select **Map** to see the weather map, which can show storms, radar information, charts and winds. Select **Area** to select from a listing of weather locations.

## Sports Info

Touch this button to view scores and schedules from a variety of sports. You can also save up to 10 favorite teams for easier access. The score automatically refreshes when a game is in progress.

## Ski Conditions

Touch this button to view ski conditions for a specific area.

## Sirius Travel Link Voice Commands



Press the voice button on the steering wheel controls. When prompted, say any of the following commands:

<b>"SIRIUS TRAVEL LINK"</b>
"5-day weather forecast"
"Fuel prices"
"Movie listings"
"Sports headlines"
"Sports schedules"
"Sports scores"
"Traffic"
"Weather"

<b>"SIRIUS TRAVEL LINK"</b>
"Weather map"
"Help"

If you say "Sports headlines", "Sports schedules" or "Sports scores", you can then say any of the commands in the following chart.

<b>Sports-related Commands</b>
"Baseball"
"College basketball"
"College football"
"Golf"
"MLS"
"My teams"
"NBA"
"NFL"
"NHL"

<b>Sports-related Commands</b>
"WNBA"
"Help"

If you want to hear headlines, schedules or scores from a particular sport, or your favorite team(s), say the sport (or team), then "headlines", "schedules" or "scores".

<b>Additional sports-related voice commands</b>
"Baseball headlines"
"Baseball schedule"
"Baseball scores"
"College basketball headlines"
"College basketball schedule"
"College basketball scores"
"College football headlines"
"College football schedule"
"College football scores"

# MyLincoln Touch™

Additional sports-related voice commands
"Golf headlines"
"Golf leaderboard"
"Golf schedule"
"MLS headlines"
"MLS schedule"
"MLS scores"
"Motor sports headlines"
"Motor sports order"
"Motor sports schedule"
"My team headlines"
"My teams schedule"
"My teams scores"
"NBA headlines"
"NBA schedule"
"NBA scores"
"NFL headlines"

Additional sports-related voice commands
"NFL schedule"
"NFL scores"
"NHL headlines"
"NHL schedule"
"NHL scores"
"WNBA headlines"
"WNBA schedule"
"WNBA scores"
"Help"

## Alerts

 If your vehicle is equipped with Navigation, touch the **i** (Information) button to access these features. If your vehicle is not equipped with Navigation, touch the corner of the touchscreen with the green tab.

Press **Alerts**, and then choose from any of the following services:

- **View** the complete message
- **Delete** the message
- **Delete All** messages

This screen displays any system messages (such as an SD card fault).

**Note:** *The system alerts you to any messages by turning the information icon yellow. After you read or delete the messages, the icon returns to white.*

## Calendar



If your vehicle is equipped with Navigation, touch the **i** (Information) button to access these features. If your vehicle is not equipped with Navigation, touch the corner of the touchscreen with the green tab.

Press **Calendar**. You can view the current calendar by day, week or month.

## 911 Assist (If Equipped)

### WARNINGS



Unless the 911 Assist setting is set on before a crash, the system will not dial for help, which could delay response time, potentially increasing the risk of serious injury or death after a crash.



Do not wait for 911 Assist to make an emergency call if you can do it yourself. Dial emergency services immediately to avoid delayed response time, which could increase the risk of serious injury or death after a crash. If you do not hear 911 Assist within five seconds of the crash, the system or phone may be damaged or non-functional.



Always place your phone in a secure location in your vehicle so it does not become a projectile or damaged in a crash. Failure to do so may cause serious injury to someone or damage the phone, which could prevent 911 Assist from working properly.

**Note:** *The SYNC 911 Assist feature must be set on prior to the incident.*

**Note:** *Before setting this feature on, make sure that you read the 911 Assist Privacy Notice later in this section for important information.*

**Note:** *If any user turns 911 Assist on or off, that setting applies for all paired phones. If 911 Assist is turned off, either a voice message plays or a display message (or icon) comes on (or both) when your vehicle is started after a previously paired phone connects.*

**Note:** *Every phone operates differently. While SYNC 911 Assist works with most cellular phones, some may have trouble using this feature.*

If a crash deploys an airbag (excludes knee airbags and rear inflatable safety belts [if equipped]) or activates the fuel pump shut-off, your SYNC-equipped vehicle may be able to contact emergency services by dialing 911 through a paired and connected Bluetooth-enabled phone. You can learn more about the 911 Assist feature, visit [www.SYNCMYRide.com](http://www.SYNCMYRide.com), [www.SYNCMYRide.ca](http://www.SYNCMYRide.ca) or [www.syncmaroute.ca](http://www.syncmaroute.ca).

See **Supplementary Restraints System** (page 43). Important information regarding airbag deployment is in this chapter.

See **Roadside Emergencies** (page 252). Important information regarding the fuel pump shut-off is in this chapter.

### Setting 911 Assist On



If your vehicle is equipped with Navigation, touch the **i** (Information) button to access these features. If your vehicle is not equipped with Navigation, touch the corner of the touchscreen with the green tab.

Touch **Apps > 911 Assist**, then select **On**.



You can also access 911 Assist by:

- Pressing the Settings icon > **Settings > Phone > 911 Assist**, or
- Pressing the Settings icon > **Help > 911 Assist**.

# MyLincoln Touch™

---

To make sure that 911 Assist works properly:

- SYNC must be powered and working properly at the time of the incident and throughout feature activation and use.
- The 911 Assist feature must be set on prior to the incident.
- You must pair and connect a Bluetooth-enabled and compatible phone to SYNC.
- A connected Bluetooth-enabled phone must have the ability to make and maintain an outgoing call at the time of the incident.
- A connected Bluetooth-enabled phone must have adequate network coverage, battery power and signal strength.
- The vehicle must have battery power and be located in the United States, Canada or in a territory in which 911 is the emergency number.

## In the Event of a Crash

Not all crashes deploy an airbag or activate the fuel pump shut-off (which would trigger 911 Assist); however, SYNC tries to contact emergency services if 911 Assist triggers. If a connected phone sustains damage or loses connection to SYNC, SYNC searches for, and tries to connect to, any available previously paired phone and tries to make the call to 911.

Before making the call:

- SYNC provides a short window of time (about 10 seconds) to cancel the call. If you fail to cancel the call, SYNC attempts to dial 911.
- SYNC says the following, or a similar message: "SYNC will attempt to call 911, to cancel the call, press Cancel on your screen or press and hold the phone button on your steering wheel."

If you do not cancel the call, and SYNC makes a successful call, a pre-recorded message plays for the 911 operator, and then the occupant(s) in your vehicle is able to talk with the operator. Be prepared to provide your name, phone number and location immediately, because not all 911 systems are capable of receiving this information electronically.

## 911 Assist May Not Work If

- Your cellular phone or 911 Assist hardware sustains damage in a crash.
- The vehicle's battery or the SYNC system has no power.
- The phones(s) previously paired or connected to the system are thrown from the vehicle.

## 911 Assist Privacy Notice

When you turn on 911 Assist, it may disclose to emergency services that your vehicle has been in a crash involving the deployment of an airbag or activation of the fuel pump shut-off. Certain versions or updates to 911 Assist may also be capable of electronically

or verbally disclosing to 911 operators your vehicle location or other details about your vehicle or crash to assist 911 operators to provide the most appropriate emergency services. If you do not want to disclose this information, do not turn the feature on.

## Vehicle Health Report (If Equipped)

### WARNING



Always follow scheduled maintenance instructions, regularly inspect your vehicle, and seek repair for any damage or problem you suspect. Vehicle Health Report supplements, but cannot replace, normal maintenance and vehicle inspection. Vehicle Health Report only monitors certain systems electronically monitored by your vehicle and will not monitor or report the status of any other system, (such as brake lining wear). Failure to perform scheduled maintenance and regularly inspect your vehicle may result in vehicle damage and serious injury.

**Note:** *This feature is only available in the United States.*

**Note:** *Your Vehicle Health Report feature requires activation prior to use. Visit [www.SYNCMYRide.com](http://www.SYNCMYRide.com) to register. There is no fee or subscription associated with Vehicle Health Report, but you must register to use this feature.*

**Note:** *This feature may not function properly if you have enabled caller ID blocking on your cellular phone. Before running a report, review the Vehicle Health Report Privacy Notice.*

**Note:** *In order to allow a break-in period for your vehicle, you may not be able to create a Vehicle Health Report until your vehicle odometer has reached 200 miles.*

**Note:** *Cellular phone and SMS charges may apply when making a report.*

Register for Vehicle Health Report and set your report preferences at [www.SYNCMYRide.com](http://www.SYNCMYRide.com). After registering, you can request a Vehicle Health Report (inside your vehicle). Return to your account at [www.SYNCMYRide.com](http://www.SYNCMYRide.com) to view your report. You can also choose for SYNC to remind you automatically to run reports at specific mileage intervals. Cellular phone airtime usage may apply when reporting.

The system allows you to check your vehicle's overall health in the form of a diagnostic report card. The Vehicle Health Report contains valuable information, such as:

- Vehicle diagnostic information
- Scheduled maintenance
- Open recalls and Field Service Actions
- Items noted during vehicle inspections by your authorized dealer that still need servicing.

## Making a Report



If you want to run a report by using the touchscreen, touch **Apps** > **Vehicle Health Report**.



To run a report by voice command, press the voice button on the steering wheel and, when prompted, say "Vehicle health report".

## Vehicle Health Report Privacy Notice

When you create a Vehicle Health Report, Ford Motor Company may collect your cellular phone number (to process your report request) and diagnostic information about your vehicle. Certain versions or updates to Vehicle Health Report may also

collect more vehicle information. Ford may use your vehicle information it collects for any purpose. If you do not want to disclose your cellular phone number or vehicle information, do not run the feature or set up your Vehicle Health Report profile at [www.SYNCMYRide.com](http://www.SYNCMYRide.com). See [www.SYNCMYRide.com](http://www.SYNCMYRide.com) (Vehicle Health Report Terms and Conditions, and Privacy Statement) for more information.

## CLIMATE

Touch the lower right corner on the touchscreen to access your climate control features. Depending on your vehicle line and option package, your climate screen may look different from this screen.

**Note:** *You can switch temperature units between Fahrenheit and Celsius. See **Settings** (page 372).*

# MyLincoln Touch™

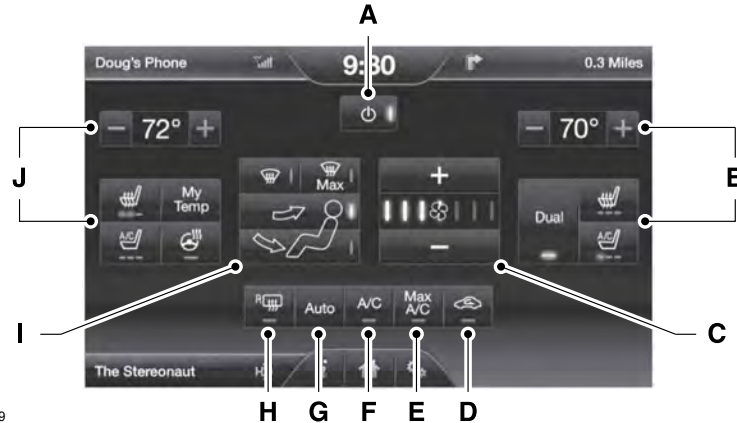

E148839

- A **Power:** Touch the button to switch the system on and off. Switching off the climate control system prevents outside air from entering the vehicle.
- B **Passenger settings:**
  - Touch the + or – to increase or decrease the air temperature on the passenger side of the vehicle.
  - Touch the heated seat icon to switch the heated seat off and on (if equipped).
  - Touch the climate-controlled seat icon to switch the climate-controlled seat off and on (if equipped).
  - Touch **DUAL** to switch separate passenger side temperature controls off and on. When you switch off DUAL, the passenger side temperature changes to match the driver side temperature.

# MyLincoln Touch™

---

**Note:** The passenger side temperature and the **DUAL** indicator automatically turn on when the passenger is adjusting their temperature control.

**Note:** See the following Smart Zone Feature section for more information on the **DUAL** button.

- C **Fan speed:** Touch + or - to increase or decrease the volume of air circulated in your vehicle.  
**Note:** When the system is controlling the fan speed automatically, all the fan speed indicators turn off.
- D **Recirculated air:** Touch the button to switch between outside air and recirculated air. When you select recirculated air, the air currently in the passenger compartment recirculates. This may reduce the time needed to cool the interior (when used with **A/C**) and may reduce unwanted odors from entering your vehicle.  
**Note:** Recirculated air may turn off automatically (or be prevented from turning on) in all airflow modes except **MAX A/C** to reduce risk of fogging. Recirculated air may also turn on and off automatically in **Panel** or **Panel and Floor** airflow modes during hot weather in order to improve cooling efficiency.
- E **MAX A/C:** Touch the button to maximize cooling. Recirculated air flows through the instrument panel vents, air conditioning automatically turns on, and the fan automatically adjusts to the highest speed.
- F **A/C:** Touch the button to switch the air conditioning compressor on or off. Use air conditioning with recirculated air to improve cooling performance and efficiency.  
**Note:** In certain conditions (such as when using Max Defrost), the air conditioning compressor may continue to operate even after you switch off the air conditioning with the **A/C** button.
- G **AUTO:** Touch the button to switch on automatic operation. Select the desired temperature using the temperature control. The system adjusts fan speed, air distribution, air conditioning operation, and selects outside air or recirculated air to heat or cool the vehicle in order to maintain the desired temperature. You can also use the **AUTO** button to switch off dual zone operation by touching and holding the button for more than two seconds.
- H **Heated rear window:** Turns the heated rear window on and off. See **Heated Windows and Mirrors** (page 142).

# MyLincoln Touch™

---

- I **Air distribution control:** Touch these buttons to switch airflow from the windshield, instrument panel, or footwell vents on or off. The system can distribute air through any combination of these vents.

**MAX Defrost:** Touch the button to maximize defrosting. Outside air flows through the windshield vents, fan automatically adjusts to the highest speed and the temperature dial returns to the full heat position. You can use this setting to defog or clear a thin covering of ice from the windshield. The heated rear window also automatically turns on when you select MAX Defrost.

**Note:** To prevent window fogging, you cannot select recirculated air when MAX Defrost is on.

- J **Driver settings:**

Touch the + or – to increase or decrease the air temperature on the passenger side of the vehicle.

Touch the heated seat icon to switch the heated seat off and on (if equipped).

Touch the climate-controlled seat icon to switch the climate-controlled seat off and on (if equipped).

Touch **MyTemp** to select your preset temperature setpoint. Touch and hold **MyTemp** to save a new preset temperature setpoint.

Touch the heated steering wheel icon to switch the heated steering wheel on and off (if equipped).

**Note:** *If your vehicle is equipped with a wood-trimmed steering wheel, it does not heat between the 10 o'clock and 2 o'clock positions.*

## Smart Zone Feature

Each time you start your vehicle and drive without an occupant in the front passenger seat, the climate control system may automatically switch to single zone mode (if it was previously in dual zone mode) in order to improve fuel economy. When this occurs, the **DUAL** button turns off and the passenger temperature changes to agree with the driver's temperature.

Press the **DUAL** button or adjust the passenger temperature to start dual zone mode without a passenger present. The system remains in dual zone mode until the start your vehicle again.

## Turning the Feature On

Press and hold the **DUAL** button for more than four seconds. Only the driver's temperature display flashes to signify that the feature is on.

# MyLincoln Touch™

## Turning the Feature Off

Press and hold the **DUAL** button for more than four seconds. Both temperature displays flash to signify that the feature is off.

## Climate Control Voice Commands



Press the voice button on the steering wheel controls. When prompted, say any of the following commands:

Climate control commands
"Climate automatic"
"Climate my temperature"
"Climate off"
"Climate on"
"Climate temperature <15.5-29.5> degrees"
"Climate temperature <60-85> degrees"
"Help"

There are additional climate control commands but in order to access them, you have to say "Climate" first. When the system is ready to listen, you may say any of the following commands:

"CLIMATE"
"A/C off"
"A/C on"
"Automatic"
"Defrost off"
"Defrost on"
"Dual off"
"Floor on"
"Fan decrease"
"Fan increase"
"MAX A/C off"
"MAX A/C on"
"My temp"

"CLIMATE"
"Off"
"On"
"Panel floor on"
"Panel on"
"Rear defrost off"
"Rear defrost on"
"Recirc off"
"Recirc on"
"Temperature"
"Temperature <15.5-29.5> degrees"
"Temperature <60-85> degrees"
"Temperature decrease"
"Temperature high"
"Temperature increase"
"Temperature low"

# MyLincoln Touch™

<b>"CLIMATE"</b>
"Windshield floor on"
"Help"

If you say "Temperature", you can then say any of the commands in the following chart.

<b>"TEMPERATURE"</b>
"<15.5-29.5> degrees"
"<60-85> degrees"
"High"
"Low"
"Help"

## NAVIGATION (If Equipped)

**Note:** *The navigation SD card must be in the SD card slot to operate the navigation system. If you need a replacement SD card, see an authorized dealer.*

**Note:** *The SD card slot is spring-loaded. To remove the SD card, just push the card in and release it. Do not attempt to pull the card out to remove it; this could cause damage.*

Your navigation system is comprised of two main features, destination mode and map mode.

To set a destination, press the green corner of your touchscreen, then the **Dest** button when it appears. See **Setting a destination** later in this chapter.

To view the navigation map and your vehicle's current location, touch the green bar in the upper right-hand corner of the touchscreen, or, press **Dest**, then **Map**. See **Map mode** later in this chapter.

## Setting a Destination

Press the green corner of your touchscreen, then the **Dest** button when it appears. Choose any of the following:

<b>Destination</b>
My Home
Favorites
Previous Destinations
Point of Interest
Emergency
Street Address
Intersection
City Center
Map
Edit Route Cancel Route

1. Enter the necessary information into the highlighted text fields (in any order). For address destination entry, the **Go!** button appears once you enter all the necessary information. Pressing the **Go!** button makes the address location appear on the map. If you choose **Previous Destination**, the last 20 destinations you have selected appear.
2. Select **Set as Dest** to make this your destination. You can also choose to set this as a waypoint (have the system route to this point on the way to your current destination) or save it as a favorite. The system considers any **Avoid Areas** selections in its route calculation.
3. Choose from up to three different types of routes, and then select **Start Route**.
  - Fastest: Uses the fastest moving roads possible.
  - Shortest: Uses the shortest distance possible.
  - Eco Route: Uses the most fuel-efficient route.

You can cancel the route or have the system demo the route for you. Select **Route Prefs** to set route preferences like avoiding freeways, tollroads, ferries and car trains as well as to use or not use high-occupancy vehicle lanes. (High-occupancy vehicle lanes are also known as carpool or diamond lanes. People who ride in buses, vanpools or carpools use these lanes.)

**Note:** *If your vehicle is on a recognized road and you do not press the **Start Route** button, the system defaults to the Fastest Route option and begins guidance.*

During route guidance, you can press the talking bubble icon that appears in the upper right navigation corner (green bar) if you want the system to repeat route guidance information. When the system repeats the last guidance instruction, it updates the distance to the next guidance instruction, since it detects when the vehicle is moving.

## Point of Interest (POI) Categories

Main categories
Food/Drink & Dining
Travel & Transportation
Financial
Emergency
Community
Health & Medicine
Automotive
Shopping
Entertainment & Arts
Recreation & Sports
Government
Domestic Services

Subcategories
Restaurant
Golf
Parking
Home & Garden
Personal Care Services
Auto Dealership
Govt Office
Public Transit
Education

To expand these listings, press the + in front of the listing.

The system also allows you to sort alphabetically, by distance or by cityseekr listings (if available).

## cityseekr

**Note:** *cityseekr point of interest (POI) information is limited to approximately 912 cities (881 in the United States, 20 in Canada and 11 in Mexico).*



E142634

cityseekr, when available, is a service that provides more information about certain points of interest such as restaurants, hotels and attractions.

When you have selected a point of interest, the location and information appear, such as address and phone number. If cityseekr lists the point of interest, more information is available, such as a brief description, check-in and checkout times or restaurant hours.

Press **More Information** for a longer review, a list of services and facilities, the average room or meal price as well as the website. This screen displays the point of interest icon such as:



Hotel



Coffeeshouse



Food & Drink



Nightlife



Attraction

# MyLincoln Touch™



This icon appears when your selection exists in multiple categories within the system.

When you are viewing more information for hotels, cityseekr also tells you if the hotel has certain services and facilities using icons, such as:

- Restaurant.
- Business center.
- Handicap facilities.
- Laundry.
- Refrigerator.
- 24 hour room service.
- Fitness center.
- Internet access.
- Pool.
- Wi-fi.

For restaurants, cityseekr can provide information such as star rating, average cost, review, handicap access, hours of operation, and website address.

For hotels, cityseekr can provide information such as star rating, price category, review, check-in and checkout times, hotel service icons and website address.

## Setting Your Navigation Preferences

Select settings for the system to take into account when planning your route.



Press the Settings icon > **Settings** > **Navigation**.

## Map Preferences

### *Breadcrumbs*

Display your vehicle's previously traveled route with white dots. Switch this feature **ON** or **OFF**.

### *Turn List Format*

Have the system display your turn list **Top to Bottom** or **Bottom to Top**.

## *Parking POI Notification*

Set the automatic parking point of interest notification. Switch this feature **ON** or **OFF**. When parking point of interest notification is on, the icons display on the map when you get close to your destination. This may not be very useful in dense areas, and may clutter the map when other points of interest display.

## Route Preferences

### *Preferred Route*

Choose to have the system display the Shortest, Fastest or most Ecological route first. If you set **Always Use Preferred Route** to **Yes**, the system uses the selected route type to calculate only one route to the desired destination.

### *Always Use Preferred Route*

Bypass route selection in destination programming. The system only calculates one route based on preferred route setting.

## **Eco Time Penalty**

Select a low, medium or high cost for the calculated Eco Route. The higher the setting, the longer the time allotment is for the route.

## **Avoid**

These features allow you to choose to have the system avoid freeways, toll roads, ferries and car trains when planning your route. Switch these features **ON** or **OFF**.

## **Use HOV Lanes**

Have the system use high-occupancy vehicle lanes, if available, when planning your route.

## **Navigation Preferences**

### **Guidance Prompts**

Have the system use **Voice & Tones** or **Tone Only** on your programmed route.

### **Auto - Fill State/Province**

Have the system automatically fill in the state and province based on the information already entered into the system. Switch this feature **ON** or **OFF**.

## **Traffic Preferences**

### **Avoid Traffic Problems**

Choose how you want the system to handle traffic problems along your route.

- **Automatic:** Have the system reroute you to avoid traffic incidents that develop and impact the current route. The system does not provide a traffic alert notification.
- **Manual:** Have the system always provide a traffic alert notification for traffic incidents along the planned route. You have a choice to accept or ignore the notification before making the route deviation.

### **Traffic Alert Notification**

Have the system display traffic alert notifications.

Other traffic alert features allows you to turn on certain, or all, traffic icons on the map such as road work, incident, accidents and closed roads. Scroll down to view all the different types of alerts. Switch these features **ON** or **OFF**.

## **Avoid Areas**

Choose areas which you want the system to avoid when calculating a route for you.

Press **Add** to program an entry. Once you make a selection, the system tries to avoid the area(s) if possible for all routes. To delete a selection, choose the listing on the screen. When the screen changes to **Avoid Areas Edit**, you can press **Delete** at the bottom right of the screen.

## **Map Mode**

Press the green bar in the upper right area of the touchscreen to view map mode. Map mode shows advanced viewing comprised of both 2D city maps as well as 3D landmarks (when available).

2D city maps show detailed outlines of buildings, visible land use and land elements and detailed railway infrastructure for the most essential cities around the globe. These maps also contain features, such as town blocks, building footprints and railways.

# MyLincoln Touch™

3D landmarks appear as clear, visible objects that are typically recognizable and have a certain tourist value. The 3D landmarks appear in 3D map mode only. Coverage varies and improves with updated map releases.



E174016

Change the appearance of the map display by repeatedly pressing the arrow button in the upper left corner of the screen. It toggles between three different map modes: Heading up, North up and 3D.



**Heading up (2D map)** always shows the direction of forward travel to be upward on the screen. This view is available for map scales up to 2.5 miles (4 kilometers). The system remembers this setting for larger map scales, but shows the map in North up only. If the scale returns below this level, the system restores Heading up.



**North up (2D map)** always shows the northern direction to be upward on the screen.



**3D map mode** provides an elevated perspective of the map. This viewing angle can be adjusted and the map can be rotated 180 degrees by touching the map twice, and then dragging your finger along the shaded bar with arrows at the bottom of the map.

**View** switches between full map, street list and exit view in route guidance.

**Menu** displays a pop-up box that allows direct access to navigation settings, View/Edit Route, SIRIUS Travel Link, Guidance Mute and Cancel Route.



Press the speaker button on the map to mute route guidance. When the light on the button illuminates, the feature is on. The speaker button appears on the map only when route guidance is active.



Re-center the map by pressing this icon whenever you scroll the map away from your vehicle's current location.

## Auto Zoom

Press the green bar to access map mode, then select the + or - zoom button to bring up the zoom level and Auto buttons on the touchscreen. When you press **Auto**, Auto Zoom turns on and **Auto** displays in the bottom left corner of the screen in the map scale. The map zoom level then synchronizes with vehicle speed. The slower your vehicle is traveling, the farther in the map zooms in; the faster your vehicle is traveling, the farther the map zooms out. To switch off the feature, just press the + or - button again.

In 3D mode, rotate the map view by swiping your finger across the shaded bar with the arrows.

The ETA box under the zoom buttons appears when a route is active and displays the distance and time to your destination. If the button is pressed, a pop up appears with the destination listed (and waypoint if applicable) along with mileage and time to destination. You may also select to have either the estimated time to reach your destination or your estimated arrival time.

## Map Icons



**Vehicle mark** shows the current location of your vehicle. It stays in the center of the map display, except when in scroll mode.



**Scroll cursor** allows you to scroll the map; the fixed icon is in the center of the screen. The map position closest to the cursor is in a window on the top center part of the screen.



**Address book entry default icon(s)** indicates the location on the map of an address book entry. This is the default symbol shown after the entry has been stored to the Address Book by any method other than the map. You can select from any of the 22 icons available. You can use each icon more than once.



**Home** indicates the location on the map currently stored as the home position. You can only save one address from the Address Book as your Home entry. You cannot change this icon.



**POI (Point Of Interest) icons** indicate locations of any point of interest categories you choose to display on the map. You can choose to display three point of interest categories on the map at one time.



**Starting point** indicates the starting point of a planned route.



**Waypoint** indicates the location of a waypoint on the map. The number inside the circle is different for each waypoint and represents the position of the waypoint in the route list.



**Destination symbol** indicates the ending point of a planned route.



**Next maneuver point** indicates the location of the next turn on the planned route.



**No GPS symbol** indicates that insufficient GPS satellite signals are available for accurate map positioning. This icon may display under normal operation in an area with poor GPS access.

## Quick-touch Buttons

When in map mode, touch anywhere on the map display to access the following options:

# MyLincoln Touch™

## Set as Dest

Touch this button to select a scrolled location on the map as your destination. You may scroll the map by pressing your index finger on the map display. When you reach the desired location, simply let go and then touch **Set as Dest**.

## Set as Waypoint

Touch this button to set the current location as a waypoint.

## Save to Favorites

Touch this button to save the current location to your favorites.

## POI Icons

Touch this button to select icons to display on the map. You can select up to three icons to display on the map at the same time. Turn these **ON** or **OFF**.

## Cancel Route

Touch this button to cancel the active route.

## View/Edit Route

Access these features when a route is active:

- View Route
- Edit Destination/Waypoints
- Edit Turn List
- Detour
- Edit Route Preferences
- Edit Traffic Preferences
- Cancel Route.

Nokia is the digital map provider for the navigation application. If you find map data errors, you may report them directly to Nokia by going to <http://mapreporter.navteq.com>. Nokia evaluates all reported map errors and responds with the result of their investigation by e-mail.

## Navigation Map Updates

Annual navigation map updates are available for purchase through your dealership, by calling 1-866-4NAVTEQ (1-866-462-8837) (in Mexico, call 01-800-557-5539) or going to [www.navigation.com/sync](http://www.navigation.com/sync). You need to specify the make and model of your vehicle to determine if there is an update available.

## Navigation Voice Commands



When in navigation mode, press the voice button on the steering wheel controls. After the tone, say any of the following commands:

Navigation system voice commands
"Cancel next waypoint" <sup>1</sup>
"Cancel route" <sup>1</sup>
"Destination" <sup>2</sup>
"Destination <nametag>"
"Destination <POI category>"

Navigation system voice commands
"Destination favorites"
"Destination home"
"Destination intersection"
"Destination nearest <POI category>"
"Destination nearest POI"
"Destination play nametags"
"Destination POI"
"Destination POI category"
"Destination previous destination"
"Destination street address"
"Detour" <sup>1</sup>
"Navigation" <sup>3</sup>
"Navigation voice volume decrease"
"Navigation voice volume increase"
"Repeat instruction" <sup>1</sup>

Navigation system voice commands
"Show 3D"
"Show heading up"
"Show map"
"Show north up"
"Show route" <sup>1</sup>
"Show turn list" <sup>1</sup>
"Voice guidance off"
"Voice guidance on"
"Where am I?"
"Zoom in"

Navigation system voice commands
"Zoom out"
"Help"

<sup>1</sup> These commands are only available when a navigation route is active.

<sup>2</sup> If you say "Destination", you can then say any command in the following "Destination" chart.

<sup>3</sup> If you say "Navigation", you can then say any command in the following "Navigation" chart.

<b>"DESTINATION"</b>
"<nametag>"
"<POI category>"
"Favorites"
"Home"
"Intersection"
"Nearest <POI category>"

# MyLincoln Touch™

<b>"DESTINATION"</b>
"Nearest POI"
"Play nametags"
"POI category"
"Previous destination"
"Street address"
"Help"

<b>"NAVIGATION"</b>
"Destination"
"Zoom city"
"Zoom country"
"Zoom minimum"
"Zoom maximum"
"Zoom province"
"Zoom state"
"Zoom street"

<b>"NAVIGATION"</b>
"Zoom to <distance>"
"Help"

If you say "Destination", you can then say any command in the "Destination" chart.

## **One-shot Destination Street Address**

When you say either "Navigation destination street address" or "Destination street address", the system asks you to say the full address. The system displays an example on-screen. You can then speak the address naturally, such as "One two three four Main Street, Anytown".

# Accessories

---

For a complete listing of the accessories that are available for your vehicle, please contact an authorized dealer or visit our online store at [www.Accessories.Lincoln.com](http://www.Accessories.Lincoln.com) (United States only).

Lincoln Custom Accessories are available for your vehicle through an authorized Lincoln dealer. Lincoln Motor Company will repair or replace any properly authorized dealer-installed Lincoln Genuine Accessory found to be defective in factory-supplied materials or workmanship during the warranty period, as well as any component damaged by the defective accessories.

Lincoln Motor Company will warrant your Lincoln Genuine Accessory through the warranty that provides the greatest benefit:

- 24 months, unlimited mileage.
- The remainder of your new vehicle limited warranty.

Contact an authorized dealer for details and a copy of the warranty.

## Exterior style

- Side-window deflectors.
- Wheels.
- Bumper protectors.

## Interior style

- All-weather floor mats.
- Rear seat entertainment\*.
- Premium carpeted floor mats.

## Lifestyle

- Ash cup (smoker's packages).
- Cargo area protector.
- Cargo net.
- Cargo organizer.

## Peace of mind

- Car cover\*.
- Wheel locks.

\*Lincoln Licensed Accessory. The accessory manufacturer designs, develops and therefore warrants Lincoln Licensed Accessories, and does not design or test these accessories to Lincoln Motor Company engineering requirements. Contact an authorized Lincoln dealer for the manufacturer's limited warranty details and request a copy of the Lincoln Licensed Accessories product limited warranty from the accessory manufacturer.

## Accessories

---

For maximum vehicle performance, keep the following information in mind when adding accessories or equipment to your vehicle:

- When adding accessories, equipment, passengers and luggage to your vehicle, do not exceed the total weight capacity of the vehicle or of the front or rear axle (GVWR or GAWR as indicated on the Safety Compliance Certification label). Consult an authorized dealer for specific weight information.
- The Federal Communications Commission (FCC) and Canadian Radio Telecommunications Commission (CRTC) regulate the use of mobile communications systems that are equipped with radio transmitters, for example, two-way radios, telephones and theft alarms. Any such equipment installed in your vehicle should comply with the Federal Communications Commission (FCC) and Canadian Radio Telecommunications Commission (CRTC) regulations and should be installed only by an authorized dealer.
- Mobile communications systems may harm the operation of your vehicle, particularly if their manufacturer did not design them specifically for automotive use.
- If you or an authorized Lincoln dealer add any non-Lincoln electrical or electronic accessories or components to your vehicle, you may adversely affect battery performance and durability. In addition, you may also adversely affect the performance of other electrical systems in the vehicle.

# Appendices

---

## END USER LICENSE AGREEMENT

### SYNC End User License Agreement (EULA)

- You have acquired a device ("DEVICE") that includes software licensed by Ford Motor Company and its affiliates ("FORD MOTOR COMPANY") from an affiliate of Microsoft Corporation ("MS"). Those installed software products of MS origin, as well as associated media, printed

materials, and "online" or electronic documentation ("MS SOFTWARE") are protected by international intellectual property laws and treaties. The MS SOFTWARE is licensed, not sold. All rights reserved.

- The MS SOFTWARE may interface with and/or communicate with, or may be later upgraded to interface with and/or communicate with additional software and/or systems provided by FORD MOTOR COMPANY. The additional software and systems of FORD MOTOR COMPANY origin, as well as associated media, printed materials, and "online" or electronic documentation ("FORD SOFTWARE") are protected by international intellectual property laws and treaties. The FORD SOFTWARE is licensed, not sold. All rights reserved.

- The MS SOFTWARE and/or FORD SOFTWARE may interface with and/or communicate with, or may be later upgraded to interface with and/or communicate with additional software and/or systems provided by third party software and service suppliers. The additional software and services of third party origin, as well as associated media, printed materials, and "online" or electronic documentation ("THIRD PARTY SOFTWARE") are protected by international intellectual property laws and treaties. The THIRD PARTY SOFTWARE is licensed, not sold. All rights reserved.
- The MS SOFTWARE, FORD SOFTWARE and THIRD PARTY SOFTWARE hereinafter collectively and individually will be referred to as "SOFTWARE".

# Appendices

---

**IF YOU DO NOT AGREE TO THIS END USER LICENSE AGREEMENT ("EULA") DO NOT USE THE DEVICE OR COPY THE SOFTWARE. ANY USE OF THE SOFTWARE, INCLUDING BUT NOT LIMITED TO USE ON THE DEVICE, WILL CONSTITUTE YOUR AGREEMENT TO THIS EULA (OR RATIFICATION OF ANY PREVIOUS CONSENT).**

**GRANT OF SOFTWARE LICENSE:** This EULA grants you the following license:

- You may use the SOFTWARE as installed on the DEVICE and as otherwise interfacing with systems and/or services provide by or through FORD MOTOR COMPANY or its third party software and service providers.

## Description of Other Rights and Limitations

- **Speech Recognition:** If the SOFTWARE includes speech recognition component(s), you should understand that speech recognition is an inherently statistical process and that recognition errors are inherent in the process. Neither FORD MOTOR COMPANY nor its suppliers shall be liable for any damages arising out of errors in the speech recognition process.
- **Limitations on Reverse Engineering, Decompilation and Disassembly:** You may not reverse engineer, decompile, or disassemble nor permit others to reverse engineer, decompile or disassemble the SOFTWARE, except and only to the extent that such activity is expressly permitted by applicable law notwithstanding this limitation.
- **Limitations on Distributing, Copying, Modifying and Creating Derivative Works:** You may not distribute, copy, make modifications to or create derivative works based on the SOFTWARE, except and only to the extent that such activity is expressly permitted by applicable law notwithstanding this limitation.
- **Single EULA:** The end user documentation for the DEVICE and related systems and services may contain multiple EULAs, such as multiple translations and/or multiple media versions (e.g., in the user documentation and in the software). Even if you receive multiple EULAs, you are licensed to use only one (1) copy of the SOFTWARE.
- **SOFTWARE Transfer:** You may permanently transfer your rights under this EULA only as part of a sale or transfer of the DEVICE, provided you retain no copies, you transfer all of the SOFTWARE (including all component parts, the media

# Appendices

---

and printed materials, any upgrades, and, if applicable, the Certificate(s) of Authenticity), and the recipient agrees to the terms of this EULA. If the SOFTWARE is an upgrade, any transfer must include all prior versions of the SOFTWARE.

- **Termination:** Without prejudice to any other rights, FORD MOTOR COMPANY or MS may terminate this EULA if you fail to comply with the terms and conditions of this EULA.
- **Security Updates/Digital Rights Management:** Content owners use the WMDRM technology included in your DEVICE to protect their intellectual property, included copyrighted content. Portions of the SOFTWARE on your DEVICE use WMDRM software to access WMDRM-protected content. If the WMDRM software fails to protect the content, content owners may ask Microsoft to revoke the SOFTWARE's ability to use WMDRM to play or copy protected content. This action does not affect unprotected content. When your DEVICE downloads licenses for protected content, you agree that Microsoft may

include a revocation list with the licenses. Content owners may require you to upgrade the SOFTWARE on your DEVICE to access their content. If you decline an upgrade, you will not be able to access content that requires the upgrade.

- **Consent to Use of Data:** You agree that MS, Microsoft Corporation, FORD MOTOR COMPANY, third party software and systems suppliers, their affiliates and/or their designated agent may collect and use technical information gathered in any manner as part of product support services related to the SOFTWARE or related services. MS, Microsoft Corporation, FORD MOTOR COMPANY, third party software and services suppliers, their affiliates and/or their designated agent may use this information solely to improve their products or to provide customized services or technologies to you. MS, Microsoft Corporation, FORD MOTOR COMPANY, third party software and systems suppliers, their affiliates and/or their designated agent may disclose this information to others, but not in a form that personally identifies you.

- **Internet-Based Services Components:** The SOFTWARE may contain components that enable and facilitate the use of certain Internet-based services. You acknowledge and agree that MS, Microsoft Corporation, FORD MOTOR COMPANY, third party software and service suppliers, their affiliates and/or their designated agent may automatically check the version of the SOFTWARE and/or its components that you are utilizing and may provide upgrades or supplements to the SOFTWARE that may be automatically downloaded to your DEVICE.
- **Additional Software/Services:** The SOFTWARE may permit FORD MOTOR COMPANY, third party software and service suppliers, MS, Microsoft Corporation, their affiliates and/or their designated agent to provide or make available to you SOFTWARE updates, supplements, add-on components, or Internet-based services components of the SOFTWARE after the date you obtain your initial copy of the SOFTWARE ("Supplemental Components").

# Appendices

---

If FORD MOTOR COMPANY or third party software and services suppliers provide or make available to you Supplemental Components and no other EULA terms are provided along with the Supplemental Components, then the terms of this EULA shall apply.

If MS, Microsoft Corporation, their affiliates and/or their designated agent make available Supplemental Components, and no other EULA terms are provided, then the terms of this EULA shall apply, except that the MS, Microsoft Corporation or affiliate entity providing the Supplemental Component(s) shall be the licensor of the Supplemental Component(s).

FORD MOTOR COMPANY, MS, Microsoft Corporation, their affiliates and/or their designated agent reserve the right to discontinue without liability any Internet-based services provided to you or made available to you through the use of the SOFTWARE.

# Appendices

---

- **Links to Third Party Sites:** The MS SOFTWARE may provide you with the ability to link to third party sites through the use of the SOFTWARE. The third party sites are not under the control of MS, Microsoft Corporation, their affiliates and/or their designated agent. Neither MS nor Microsoft Corporation nor their affiliates nor their designated agent are responsible for (i) the contents of any third party sites, any links contained in third party sites, or any changes or updates to third party sites, or (ii) webcasting or any other form of transmission received from any third party sites. If the SOFTWARE provides links to third party sites, those links are provided to you only as a convenience, and the inclusion of any link does not imply an endorsement of the third party site by MS, Microsoft Corporation, their affiliates and/or their designated agent.

- **Obligation to Drive Responsibly:** You recognize your obligation to drive responsibly and keep attention on the road. You will read and abide with the DEVICE operating instructions particularly as they pertain to safety and assumes any risk associated with the use of the DEVICE.

**UPGRADES AND RECOVERY MEDIA:** If the SOFTWARE is provided by FORD MOTOR COMPANY separate from the DEVICE on media such as a ROM chip, CD ROM disk(s) or via web download or other means, and is labeled "For Upgrade Purposes Only" or "For Recovery Purposes Only" you may install one (1) copy of such SOFTWARE onto the DEVICE as a replacement copy for the existing SOFTWARE, and use it in accordance with this EULA, including any additional EULA terms accompanying the upgrade SOFTWARE.

**INTELLECTUAL PROPERTY RIGHTS:** All title and intellectual property rights in and to the SOFTWARE (including but not limited to any images, photographs, animations, video, audio, music, text and "applets" incorporated into the SOFTWARE), the accompanying

printed materials, and any copies of the SOFTWARE, are owned by MS, Microsoft Corporation, FORD MOTOR COMPANY, or their affiliates or suppliers. The SOFTWARE is licensed, not sold. You may not copy the printed materials accompanying the SOFTWARE. All title and intellectual property rights in and to the content which may be accessed through use of the SOFTWARE is the property of the respective content owner and may be protected by applicable copyright or other intellectual property laws and treaties. This EULA grants you no rights to use such content. All rights not specifically granted under this EULA are reserved by MS, Microsoft Corporation, FORD MOTOR COMPANY, third party software and service providers, their affiliates and suppliers. Use of any on-line services which may be accessed through the SOFTWARE may be governed by the respective terms of use relating to such services. If this SOFTWARE contains documentation that is provided only in electronic form, you may print one copy of such electronic documentation.

# Appendices

---

**EXPORT RESTRICTIONS:** You acknowledge that the SOFTWARE is subject to U.S. and European Union export jurisdiction. You agree to comply with all applicable international and national laws that apply to the SOFTWARE, including the U.S. Export Administration Regulations, as well as end-user, end-use and destination restrictions issued by U.S. and other governments. For additional information, see <http://www.microsoft.com/exporting/>.

**TRADEMARKS:** This EULA does not grant you any rights in connection with any trademarks or service marks of FORD MOTOR COMPANY, MS, Microsoft Corporation, third party software or service providers, their affiliates or suppliers.

**PRODUCT SUPPORT:** Product support for the SOFTWARE is not provided by MS, its parent corporation Microsoft Corporation, or their affiliates or subsidiaries. For product support, please refer to FORD MOTOR COMPANY instructions provided in the

documentation for the DEVICE. Should you have any questions concerning this EULA, or if you desire to contact FORD MOTOR COMPANY for any other reason, please refer to the address provided in the documentation for the DEVICE.

**No Liability for Certain Damages:** EXCEPT AS PROHIBITED BY LAW, FORD MOTOR COMPANY, ANY THIRD PARTY SOFTWARE OR SERVICES SUPPLIERS, MS, MICROSOFT CORPORATION AND THEIR AFFILIATES SHALL HAVE NO LIABILITY FOR ANY INDIRECT, SPECIAL, CONSEQUENTIAL OR INCIDENTAL DAMAGES ARISING FROM OR IN CONNECTION WITH THE USE OR PERFORMANCE OF THE SOFTWARE. THIS LIMITATION SHALL APPLY EVEN IF ANY REMEDY FAILS OF ITS ESSENTIAL PURPOSE. IN NO EVENT SHALL MS, MICROSOFT CORPORATION AND/OR THEIR AFFILIATES BE LIABLE FOR ANY AMOUNT IN EXCESS OF U.S. TWO HUNDRED FIFTY DOLLARS (U.S. \$250.00).

- THERE ARE NO WARRANTIES OTHER THAN THOSE THAT MAY EXPRESSLY BE PROVIDED FOR YOUR NEW VEHICLE.

## **Adobe**

Contains Adobe® [Flash® Player] or [AIR®] technology by Adobe Systems Incorporated. This [Licensee Product] contains [Adobe® Flash® Player][Adobe® AIR®] software under license from Adobe Systems Incorporated, Copyright ©1995-2009 Adobe Macromedia Software LLC. All rights reserved. Adobe, Flash and AIR are trademarks of Adobe Systems Incorporated.

## **End User Notice**

### ***Microsoft® Windows® Mobile for Automotive Important Safety Information***

This system Ford SYNC contains software that is licensed to Manufacturer FORD MOTOR COMPANY by an affiliate of Microsoft Corporation pursuant to a license agreement. Any removal, reproduction, reverse engineering or other unauthorized use of the software from this system in violation of the license agreement is strictly prohibited and may subject you to legal action.

# Appendices

---

**Read and follow instructions:** Before using your Windows Automotive- based system, read and follow all instructions and safety information provided in this end user manual ("User's Guide"). Not following precautions found in this User's Guide can lead to an accident or other serious consequences.

**Keep User's Guide in vehicle:** When kept in the vehicle, the User's Guide will be a ready reference for you and other users unfamiliar with the Windows Automotive-based system. Please make certain that before using the system for the first time, all persons have access to the User's Guide and read its instructions and safety information carefully.

## WARNING



Operating certain parts of this system while driving can distract your attention away from the road, and possibly cause an accident or other serious consequences. Do not change system settings or enter data non-verbally (using your hands) while driving. Stop the vehicle in a safe and legal manner before attempting these operations. This is important since while setting up or changing some functions you might be required to distract your attention away from the road and remove your hands from the wheel.

### *General Operation*

**Voice Command Control:** Functions within the Windows Automotive-based system may be accomplished using only voice commands. Using voice commands while driving allows you to operate the system without removing your hands from the wheel.

**Prolonged Views of Screen:** Do not access any function requiring a prolonged view of the screen while you are driving. Pull over in a safe and legal manner before attempting to access a function of the system requiring prolonged attention. Even occasional short scans to the screen may be hazardous if your attention has been diverted away from your driving task at a critical time.

**Volume Setting:** Do not raise the volume excessively. Keep the volume at a level where you can still hear outside traffic and emergency signals while driving. Driving while unable to hear these sounds could cause an accident.

**Use of Speech Recognition Functions:** Speech recognition software is inherently a statistical process which is subject to errors. It is your responsibility to monitor any speech recognition functions included in the system and address any errors.

# Appendices

---

**Navigation Features:** Any navigation features included in the system are intended to provide turn by turn instructions to get you to a desired destination. Please make certain all persons using this system carefully read and follow instructions and safety information fully.

**Distraction Hazard:** Any navigation features may require manual (non-verbal) setup. Attempting to perform such set-up or insert data while driving can seriously distract your attention and could cause an accident or other serious consequences. Stop the vehicle in a safe and legal manner before attempting these operations.

**Let Your Judgment Prevail:** Any navigation features are provided only as an aid. Make your driving decisions based on your observations of local conditions and existing traffic regulations. Any such feature is not a substitute for your personal judgment. Any route suggestions made by this system should never replace any local traffic regulations or your personal judgment or knowledge of safe driving practices.

**Route Safety:** Do not follow the route suggestions if doing so would result in an unsafe or illegal maneuver, if you would be placed in an unsafe situation, or if you would be directed into an area that you consider unsafe. The driver is ultimately responsible for the safe operation of the vehicle and therefore, must evaluate whether it is safe to follow the suggested directions.

**Potential Map Inaccuracy:** Maps used by this system may be inaccurate because of changes in roads, traffic controls or driving conditions. Always use good judgment and common sense when following the suggested routes.

**Emergency Services:** Do not rely on any navigation features included in the system to route you to emergency services. Ask local authorities or an emergency services operator for these locations. Not all emergency services such as police, fire stations, hospitals and clinics are likely to be contained in the map database for such navigation features.

## **TeleNav Software End User License Agreement**

Please read these terms and conditions carefully before you use the Telenav Software. Your use of the Telenav Software indicates that you accept these terms and conditions. If you do not accept these terms and conditions, do not break the seal of the package, launch, or otherwise use the Telenav Software.

These terms and conditions represent the agreement (“Agreement”) between you and Telenav, Inc. (“Telenav”) with respect to the Telenav Software (including upgrades, modifications, or additions thereto) (collectively “Telenav Software”). All references herein to “you” and “your” means you, your employees, agents, and contractors, and any other entity on whose behalf you accept these terms and conditions, all of whom shall also be bound by this Agreement. Additionally, all of your

# Appendices

---

account information, as well as other payment and personal information provided by you to Telenav (directly or through the use of the Telenav Software, is subject to Telenav's privacy policy located at <http://www.telenav.com>.

Telenav may revise this Agreement and the privacy policy at any time, with or without notice to you. You agree to visit <http://www.telenav.com> from time to time to review the then current version of this Agreement and of the privacy policy.

## **1. Safe and Lawful Use**

You acknowledge that devoting attention to the Telenav Software may pose a risk of injury or death to you and others in situations that otherwise require your undivided attention, and you therefore agree to comply with the following when using the Telenav Software: (a) observe all traffic laws and otherwise drive safely; (b) use your own personal judgment while driving. If you feel that a route suggested by the Telenav Software instructs you to perform an unsafe or illegal maneuver, places you in an unsafe situation, or directs you into an area that you

consider to be unsafe, do not follow such instructions; (c) do not input destinations, or otherwise manipulate the Telenav Software, unless your vehicle is stationary and parked; (d) do not use the Telenav Software for any illegal, unauthorized, unintended, unsafe, hazardous, or unlawful purposes, or in any manner inconsistent with this Agreement; (e) arrange all GPS and wireless devices and cables necessary for use of the Telenav Software in a secure manner in your vehicle so that they will not interfere with your driving and will not prevent the operation of any safety device (such as an airbag).

You agree to indemnify and hold Telenav harmless against all claims resulting from any dangerous or otherwise inappropriate use of the Telenav Software in any moving vehicle, including as a result of your failure to comply with the directions above.

## **2. Account Information**

You agree: (a) when registering the Telenav Software, to provide Telenav with true, accurate, current, and complete information about yourself, and (b) to inform Telenav promptly of any changes to such information, and to keep it true, accurate, current and complete.

## **3. Software License**

Subject to your compliance with the terms of this Agreement, Telenav hereby grants to you a personal, non-exclusive, non-transferable license (except as expressly permitted below in connection with your permanent transfer of the Telenav Software license), without the right to sublicense, to use the Telenav Software (in object code form only) in order to access and use the Telenav Software. This license shall terminate upon any termination or expiration of this Agreement. You agree that you will use the Telenav Software only for your personal business or leisure purposes, and not to provide commercial navigation services to other parties.

# Appendices

---

## **3.1 License Limitations**

You agree not to do any of the following: (a) reverse engineer, decompile, disassemble, translate, modify, alter or otherwise change the Telenav Software or any part thereof; (b) attempt to derive the source code, audio library or structure of the Telenav Software without the prior express written consent of Telenav; (c) remove from the Telenav Software, or alter, any of Telenav's or its suppliers' trademarks, trade names, logos, patent or copyright notices, or other notices or markings; (d) distribute, sublicense or otherwise transfer the Telenav Software to others, except as part of your permanent transfer of the Telenav Software; or (e) use the Telenav Software in any manner that (i) infringes the intellectual property or proprietary rights, rights of publicity or privacy or other rights of any party, (ii) violates any law, statute, ordinance or regulation, including but not limited to laws and regulations related to spamming, privacy, consumer and child protection, obscenity or defamation, or (iii) is harmful, threatening,

abusive, harassing, tortuous, defamatory, vulgar, obscene, libelous, or otherwise objectionable; and (f) lease, rent out, or otherwise permit unauthorized access by third parties to the Telenav Software without advanced written permission of Telenav.

## **4. Disclaimers**

To the fullest extent permissible pursuant to applicable law, in no event will Telenav, its licensors and suppliers, or agents or employees of any of the foregoing, be liable for any decision made or action taken by you or anyone else in reliance on the information provided by the Telenav Software. Telenav also does not warrant the accuracy of the map or other data used for the Telenav Software. Such data may not always reflect reality due to, among other things, road closures, construction, weather, new roads and other changing conditions. You are responsible for the entire risk arising out of your use of the Telenav Software. For example but without limitation, you agree not to rely on the Telenav Software for critical navigation in areas where the well-being or

survival of you or others is dependent on the accuracy of navigation, as the maps or functionality of the Telenav Software are not intended to support such high risk applications, especially in more remote geographical areas.

TELENAV EXPRESSLY DISCLAIMS AND EXCLUDES ALL WARRANTIES IN CONNECTION WITH THE TELENNAV SOFTWARE, WHETHER STATUTORY, EXPRESS OR IMPLIED, INCLUDING ALL WARRANTIES WHICH MAY ARISE FROM COURSE OF DEALING, CUSTOM OR TRADE AND INCLUDING, BUT NOT LIMITED TO, THE IMPLIED WARRANTIES OF MERCHANTABILITY, FITNESS FOR A PARTICULAR PURPOSE AND NON-INFRINGEMENT OF THIRD PARTY RIGHTS WITH RESPECT TO THE TELENNAV SOFTWARE. Certain jurisdictions do not permit the disclaimer of certain warranties, so this limitation may not apply to you.

# Appendices

---

## **5. Limitation of Liability**

TO THE EXTENT PERMITTED UNDER APPLICABLE LAW, UNDER NO CIRCUMSTANCES SHALL TELENAV OR ITS LICENSORS AND SUPPLIERS BE LIABLE TO YOU OR TO ANY THIRD PARTY FOR ANY INDIRECT, INCIDENTAL, CONSEQUENTIAL, SPECIAL OR EXEMPLARY DAMAGES (INCLUDING IN EACH CASE, BUT NOT LIMITED TO, DAMAGES FOR THE INABILITY TO USE THE EQUIPMENT OR ACCESS DATA, LOSS OF DATA, LOSS OF BUSINESS, LOSS OF PROFITS, BUSINESS INTERRUPTION OR THE LIKE) ARISING OUT OF THE USE OF OR INABILITY TO USE THE TELENAV SOFTWARE, EVEN IF TELENAV HAS BEEN ADVISED OF THE POSSIBILITY OF SUCH DAMAGES.

NOTWITHSTANDING ANY DAMAGES THAT YOU MIGHT INCUR FOR ANY REASON WHATSOEVER (INCLUDING, WITHOUT LIMITATION, ALL DAMAGES REFERENCED HEREIN AND ALL DIRECT OR GENERAL DAMAGES IN CONTRACT, TORT (INCLUDING NEGLIGENCE) OR OTHERWISE), THE ENTIRE LIABILITY OF TELENAV AND OF ALL OF TELENAV'S SUPPLIERS SHALL

BE LIMITED TO THE AMOUNT ACTUALLY PAID BY YOU FOR THE TELENAV SOFTWARE. SOME STATES AND/OR JURISDICTIONS DO NOT ALLOW THE EXCLUSION OR LIMITATION OF INCIDENTAL OR CONSEQUENTIAL DAMAGES, SO THE ABOVE LIMITATIONS OR EXCLUSIONS MAY NOT APPLY TO YOU.

## **6. Arbitration and Governing Law**

You agree that any dispute, claim or controversy arising out of or relating to this Agreement or the Telenav Software shall be settled by independent arbitration involving a neutral arbitrator and administered by the American Arbitration Association in the County of Santa Clara, California. The arbitrator shall apply the Commercial Arbitration Rules of the American Arbitration Association, and the judgment upon the award rendered by the arbitrator may be entered by any court having jurisdiction. Note that there is no judge or jury in an arbitration proceeding and the decision of the arbitrator shall be binding upon both parties. You expressly agree to waive your right to a jury trial.

This Agreement and performance hereunder will be governed by and construed in accordance with the laws of the State of California, without giving effect to its conflict of laws provisions. To the extent judicial action is necessary in connection with the binding arbitration, both Telenav and you agree to submit to the exclusive jurisdiction of the courts of the County of Santa Clara, California. The United Nations Convention on Contracts for the International Sale of Goods shall not apply.

## **7. Assignment**

You may not resell, assign, or transfer this Agreement or any of your rights or obligations, except in totality, in connection with your permanent transfer of the Telenav Software, and expressly conditioned upon the new user of the Telenav Software agreeing to be bound by the terms and conditions of this Agreement. Any such sale, assignment or transfer that is not expressly permitted under this paragraph will result in immediate termination of this Agreement, without liability to Telenav, in which case you

# Appendices

---

and all other parties shall immediately cease all use of the Telenav Software.

Notwithstanding the foregoing, Telenav may assign this Agreement to any other party at any time without notice, provided the assignee remains bound by this Agreement.

## **8. Miscellaneous**

### **8.1**

This Agreement constitutes the entire agreement between Telenav and you with respect to the subject matter hereof.

### **8.2**

Except for the limited licenses expressly granted in this Agreement, Telenav retains all right, title and interest in and to the Telenav Software, including without limitation all related intellectual property rights. No licenses or other rights which are not expressly granted in this Agreement are

intended to, or shall be, granted or conferred by implication, statute, inducement, estoppel or otherwise, and Telenav and its suppliers and licensors hereby reserve all of their respective rights other than the licenses explicitly granted in this Agreement.

### **8.3**

By using the Telenav Software, you consent to receive from Telenav all communications, including notices, agreements, legally required disclosures or other information in connection with the Telenav Software (collectively, “Notices”) electronically. Telenav may provide such Notices by posting them on Telenav’s Website or by downloading such Notices to your wireless device. If you desire to withdraw your consent to receive Notices electronically, you must discontinue your use of the Telenav Software.

### **8.4**

Telenav’s or your failure to require performance of any provision shall not affect that party’s right to require performance at any time thereafter, nor shall a waiver of any breach or default of this Agreement constitute a waiver of any subsequent breach or default or a waiver of the provision itself.

### **8.5**

If any provision herein is held unenforceable, then such provision will be modified to reflect the intention of the parties, and the remaining provisions of this Agreement will remain in full force and effect.

# Appendices

---

## 8.6

The headings in this Agreement are for convenience of reference only, will not be deemed to be a part of this Agreement, and will not be referred to in connection with the construction or interpretation of this Agreement. As used in this Agreement, the words “include” and “including,” and variations thereof, will not be deemed to be terms of limitation, but rather will be deemed to be followed by the words “without limitation”.

## 9. Other Vendors Terms and Conditions

The Telenav Software utilizes map and other data licensed to Telenav by third party vendors for the benefit of you and other end users. This Agreement includes end-user terms applicable to these companies (included at the end of this Agreement), and thus your use of the Telenav Software is also subject to such terms. You agree to comply with the following additional terms and conditions, which are applicable to Telenav’s third party vendor licensors:

### End User License Agreement For Distribution By HERE For North America/APAC

The content provided (“Data”) is licensed, not sold. By opening this package, or installing, copying, or otherwise using the Data, you agree to be bound by the terms of this agreement. If you do not agree to the terms of this agreement, you are not permitted to install, copy, use, resell or transfer the Data. If you wish to reject the terms of this agreement, and have not installed, copied, or used the Data, you must contact your retailer or HERE North America, LLC (as defined below) within thirty (30) days of purchase for a refund of your purchase price. To contact HERE, please visit [www.here.com](http://www.here.com).

The Data is provided for your personal, internal use only and may not be resold. It is protected by copyright, and is subject to the following terms (this “End User License Agreement”) and conditions which are agreed to by you, on the one hand, and HERE and its licensors (including their licensors and suppliers) on the other hand.

For purposes of these terms, “HERE” shall mean (a) HERE North America, LLC with respect to Data for the Americas and/or the Asia Pacific region and (b) HERE Europe B.V. for Data for Europe, the Middle East and/or Africa.

The Data includes certain information and related content provided under license to HERE from third parties and is subject to the applicable supplier terms and copyright notices set forth at the following URL: [http://corporate.navteq.com/supplier\\_terms.html](http://corporate.navteq.com/supplier_terms.html).

### TERMS AND CONDITIONS

#### License Limitations on Use:

You agree that your license to use this Data is limited to and conditioned on use for solely personal, noncommercial purposes, and not for service bureau, timesharing or other similar purposes. Except as otherwise set forth herein, you agree not to otherwise reproduce, copy, modify, decompile, disassemble or reverse engineer any portion of this Data, and may not transfer or distribute it in any form, for any purpose, except to the extent permitted by mandatory laws.

# Appendices

---

## **License Limitations on Transfer:**

Your limited license does not allow transfer or resale of the Data, except on the condition that you may transfer the Data and all accompanying materials on a permanent basis if: (a) you retain no copies of the Data; (b) the recipient agrees to the terms of this End-User License Agreement; and (c) you transfer the Data in the exact same form as you purchased it by physically transferring the original media (e.g., the CD-ROM or DVD you purchased), all original packaging, all Manuals and other documentation. Specifically, Multi-disc sets may only be transferred or sold as a complete set as provided to you and not as a subset thereof.

## **Additional License Limitations:**

Except where you have been specifically licensed to do so by HERE in a separate written agreement, and without limiting the preceding paragraph, your license is conditioned on use of the Data as prescribed in this agreement, and you may not (a) use this Data with any products, systems, or applications installed or otherwise connected to or in communication with vehicles capable

of vehicle navigation, positioning, dispatch, real time route guidance, fleet management or similar applications; or (b) with, or in communication with, including without limitation, cellular phones, palmtop and handheld computers, pagers, and personal digital -assistants or PDAs.

**Note:** *This Data may contain inaccurate or incomplete information due to the passage of time, changing circum-stances, sources used and the nature of collecting comprehensive geographic Data, any of which may lead to incorrect results.*

## **No Warranty:**

This Data is provided to you “as is”, and you agree to use it at your own risk. HERE and its licensors (and their licensors and suppliers) make no guarantees, representations or warranties of any kind, express or implied, arising by law or otherwise, including but not limited to,

content, quality, accuracy, completeness, effectiveness, reliability, fitness for a particular purpose, usefulness, use or results to be obtained from this Data, or that the Data or server will be uninterrupted or error -free.

## **Disclaimer of Warranty:**

HERE AND ITS LICENSORS (INCLUDING THEIR LICENSORS AND SUPPLIERS) DISCLAIM ANY WARRANTIES, EXPRESS OR IMPLIED, OF QUALITY, PERFORMANCE, MERCHANTABILITY, FITNESS FOR A PARTICULAR PURPOSE OR NON-INFRINGEMENT. Some States, Territories and Countries do not allow certain warranty exclusions, so to that extent the above exclusion may not apply to you.

## **Disclaimer of Liability:**

HERE AND ITS LICENSORS (INCLUDING THEIR LICENSORS AND SUPPLIERS) SHALL NOT BE LIABLE TO YOU IN RESPECT OF ANY CLAIM, DEMAND OR ACTION, IRRESPECTIVE OF THE NATURE OF THE CAUSE OF THE CLAIM, DEMAND OR ACTION ALLEGING ANY LOSS, INJURY OR

# Appendices

---

DAMAGES, DIRECT OR INDIRECT, WHICH MAY RESULT FROM THE USE OR POSSESSION OF THIS DATA; OR FOR ANY LOSS OF PROFIT, REVENUE, CONTRACTS OR SAVINGS, OR ANY OTHER DIRECT, INDIRECT, INCIDENTAL, SPECIAL OR CONSEQUENTIAL DAMAGES ARISING OUT OF YOUR USE OF OR INABILITY TO USE THIS DATA, ANY DEFECT IN THIS DATA, OR THE BREACH OF THESE TERMS OR CONDITIONS, WHETHER IN AN ACTION IN CONTRACT OR TORT OR BASED ON A WARRANTY, EVEN IF HERE OR ITS LICENSORS HAVE BEEN ADVISED OF THE POSSIBILITY OF SUCH DAMAGES. Some States, Territories and Countries do not allow certain liability exclusions or damages limitations, so to that extent the above may not apply to you.

### **Export Control:**

You agree not to export from anywhere any part of the Data or any direct product thereof except in compliance with, and with all licenses and approvals required under, applicable export laws, rules and regulations, including but not limited to the laws, rules

and regulations administered by the Office of Foreign Assets Control of the U.S. Department of Commerce and the Bureau of Industry and Security of the U.S. Department of Commerce. To the extent that any such export laws, rules or regulations prohibit HERE from complying with any of its obligations hereunder to deliver or distribute Data, such failure shall be excused and shall not constitute a breach of this Agreement.

### **Entire Agreement:**

These terms and conditions constitute the entire agreement between HERE (and its licensors, including their licensors and suppliers) and you pertaining to the subject matter hereof, and supersedes in their entirety any and all written or oral agreements previously existing between us with respect to such subject matter.

### **Severability:**

You and HERE agree that if any portion of this agreement is found illegal or unenforceable, that portion shall be severed and the remainder of the Agreement shall be given full force and effect.

### **Severability:**

You and HERE agree that if any portion of this agreement is found illegal or unenforceable, that portion shall be severed and the remainder of the Agreement shall be given full force and effect.

### **Governing Law:**

The above terms and conditions shall be governed by the laws of the State of Illinois (for Data for the Americas and/or the Asia Pacific region) or The Netherlands (for Data for Europe, the Middle East and Africa), without giving effect to (i) its conflict of laws provisions, or (ii) the United Nations Convention for Contracts for the International Sale of Goods, which is explicitly excluded. For any and all disputes, claims and actions arising from or in connection with the Data (“Claims”), you agree to submit to the personal jurisdiction of (a) the State of Illinois for Claims related to Data for the Americas and/or the Asia Pacific region provided to you hereunder, and (b) The Netherlands for Data for Europe, the Middle East and/or Africa provided to you hereunder.

# Appendices

## **Government End Users:**

If the Data is being acquired by or on behalf of the United States government or any other entity seeking or applying rights similar to those customarily claimed by the United States government, this Data is a “commercial item” as that term is defined at 48 C.F.R. (“FAR”) 2.101, is licensed in accordance with this End User License Agreement, and each copy of Data delivered or otherwise furnished shall be marked and embedded as appropriate with the following “Notice of Use”, and be treated in accordance with such Notice:

### **NOTICE OF USE**

CONTRACTOR (MANUFACTURER/SUPPLIER)

NAME:

### **HERE**

CONTRACTOR (MANUFACTURER/SUPPLIER)

ADDRESS:

**425 West Randolph Street, Chicago, IL  
60606.**

This Data is a commercial item as defined in FAR 2.101

and is subject to the End User License Agreement under

which this Data was provided.

© 1987-2013 HERE. All rights reserved.

If the Contracting Officer, federal government agency, or any federal official refuses to use the legend provided herein, the Contracting Officer, federal government agency, or any federal official must notify HERE prior to seeking additional or alternative rights in the Data.

### **Gracenote® Copyright**

CD and music-related data from Gracenote, Inc., copyright© 2000-2007 Gracenote. Gracenote Software, copyright © 2000-2007 Gracenote. This product and service may practice one or more of the following U.S. Patents #5,987,525, #6,061,680, #6,154,773, #6,161,132, #6,230,192, #6,230,207, #6,240,459, #6,330,593 and other patents issued or pending. Some services supplied under license from Open Globe, Inc. for U.S. Patent: #6,304,523.

Gracenote and CDDB are registered trademarks of Gracenote. The Gracenote logo and logotype, and the "Powered by Gracenote™" logo are trademarks of Gracenote.

### **Gracenote® End User License Agreement (EULA)**

This device contains software from Gracenote, Inc. of 2000 Powell Street Emeryville, California 94608 ("Gracenote").

The software from Gracenote (the "Gracenote Software") enables this device to do disc and music file identification and obtain music-related information, including name, artist, track, and title information ("Gracenote Data") from online servers ("Gracenote Servers"), and to perform other functions. You may use Gracenote Data only by means of the intended End User functions of this device.

# Appendices

---

This device may contain content belonging to Gracenote's providers. If so, all of the restrictions set forth herein with respect to Gracenote Data shall also apply to such content and such content providers shall be entitled to all of the benefits and protections set forth herein that are available to Gracenote.

You agree that you will use the content from Gracenote ("Gracenote Content"), Gracenote Data, the Gracenote Software, and Gracenote Servers for your own personal, non-commercial use only. You agree not to assign, copy, transfer or transmit the Gracenote Content, Gracenote Software or any Gracenote Data (except in a Tag associated with a music file) to any third party. **YOU AGREE NOT TO USE OR EXPLOIT GRACENOTE CONTENT, GRACENOTE DATA, THE GRACENOTE SOFTWARE, OR GRACENOTE SERVERS, EXCEPT AS EXPRESSLY PERMITTED HEREIN.**

You agree that your non-exclusive licenses to use the Gracenote Content, Gracenote Data, the Gracenote Software, and Gracenote Servers will terminate if you violate these restrictions. If your licenses terminate, you agree to cease any and all use of the Gracenote Content, Gracenote Data, the Gracenote Software, and Gracenote Servers. Gracenote, respectively, reserve all rights in Gracenote Data, the Gracenote Software, and the Gracenote Servers and Gracenote Content, including all ownership rights. Under no circumstances will either Gracenote become liable for any payment to you for any information that you provide, including any copyrighted material or music file information. You agree that Gracenote may enforce its respective rights, collectively or separately, under this agreement against you, directly in each company's own name.

Gracenote uses a unique identifier to track queries for statistical purposes. The purpose of a randomly assigned numeric identifier is to allow Gracenote to count queries without knowing anything about who you are. For more information, see the web page at [www.gracenote.com](http://www.gracenote.com) for the Gracenote Privacy Policy.

**THE GRACENOTE SOFTWARE, EACH ITEM OF GRACENOTE DATA AND THE GRACENOTE CONTENT ARE LICENSED TO YOU "AS IS". NEITHER GRACENOTE MAKES ANY REPRESENTATIONS OR WARRANTIES, EXPRESS OR IMPLIED, REGARDING THE ACCURACY OF ANY GRACENOTE DATA FROM THE GRACENOTE SERVERS OR GRACENOTE CONTENT. GRACENOTE COLLECTIVELY AND SEPARATELY RESERVE THE RIGHT TO DELETE DATA AND/OR CONTENT FROM THE COMPANIES' RESPECTIVE SERVERS OR, IN THE CASE OF GRACENOTE, CHANGE DATA CATEGORIES FOR ANY CAUSE THAT GRACENOTE DEEMS SUFFICIENT. NO WARRANTY IS MADE THAT EITHER GRACENOTE CONTENT OR THE GRACENOTE SOFTWARE OR GRACENOTE SERVERS ARE**

# Appendices

---

ERROR-FREE OR THAT THE FUNCTIONING OF THE GRACENOTE SOFTWARE OR GRACENOTE SERVERS WILL BE UNINTERRUPTED. GRACENOTE IS NOT OBLIGATED TO PROVIDE YOU WITH ANY ENHANCED OR ADDITIONAL DATA TYPES THAT GRACENOTE MAY CHOOSE TO PROVIDE IN THE FUTURE AND IS FREE TO DISCONTINUE ITS ONLINE SERVICES AT ANY TIME. GRACENOTE DISCLAIMS ALL WARRANTIES EXPRESS OR IMPLIED, INCLUDING, BUT NOT LIMITED TO, IMPLIED WARRANTIES OF MERCHANTABILITY, FITNESS FOR A PARTICULAR PURPOSE, TITLE, AND NON-INFRINGEMENT. NEITHER GRACENOTE WARRANTS THE RESULTS THAT WILL BE OBTAINED BY YOUR USE OF THE GRACENOTE SOFTWARE OR ANY GRACENOTE SERVER. IN NO CASE WILL GRACENOTE BE LIABLE FOR ANY CONSEQUENTIAL OR INCIDENTAL DAMAGES OR FOR ANY LOST PROFITS OR LOST REVENUES FOR ANY REASON WHATSOEVER.

© Gracenote 2007.

**Vehicle with SYNC only**

FCC ID: KMHSG1G1

IC: 1422A-SG1G1

**Vehicle with SYNC and MyFord Touch or MyLincoln Touch**

FCC ID: KMHSYNG2

IC: 1422A-SYNG2

This device complies with Part 15 of the FCC Rules and with RSS-210 of Industry Canada. Operation is subject to the following two conditions: (1) This device may not cause harmful interference, and (2) this device must accept any interference received, including interference that may cause undesired operation.

## WARNING



Changes or modifications not expressly approved by the party responsible for compliance could void the user's authority to operate the equipment. The term "IC" before the radio certification number only signifies that Industry Canada technical specifications were met.

---

The antenna used for this transmitter must not be co-located or operating in conjunction with any other antenna or transmitter.

# Extended Service Plan (ESP)

---

PROTECT YOURSELF FROM THE RISING COST OF VEHICLE REPAIRS WITH A LINCOLN EXTENDED SERVICE PLAN.

## SERVICE PLANS (U.S. Only)

Lincoln owners have discovered the powerful protection of Lincoln Extended Service Plan. It is the only extended service plan backed by Lincoln Motor Company, and provides peace of mind protection beyond the New Vehicle Limited Warranty coverage.

### Lincoln ESP Can Quickly Pay for Itself

One service bill – the cost of parts and labor – can easily exceed the price of your Lincoln Extended Service Plan. With Lincoln ESP, you minimize your risk for unexpected repair bills and rising repair costs.

### Up to 1000+ Covered Vehicle Components

There are four Extended Service Plans with different levels of coverage. Ask your authorized dealer for details.

1. PremiumCARE - Our most comprehensive coverage. With over 1000 covered components, this plan is so complete that we generally only discuss what's not covered.
2. ExtraCARE - Covers 113 components, and includes many high-tech items.
3. BaseCARE - Covers 84 components.
4. PowertrainCARE - Covers 29 critical components.

Lincoln Extended Service Plan is honored by all authorized Lincoln and Ford dealers in the U.S. and Canada. It is the only extended service plan authorized and backed by Lincoln Motor Company.

That means you get:

- Reliable, quality service at any Lincoln or Ford dealership.
- Repairs performed by factory trained technicians, using genuine parts.

## Rental Car Reimbursement

### *1st day Rental Benefit*

You take advantage of replacement transportation if your vehicle is at your authorized dealer for same day covered repairs.

### *Extended Rental Benefits*

If your vehicle is kept overnight for covered repairs, you are eligible for rental car coverage, including bumper to bumper warranty repairs, and Field Service Actions.

## Roadside Assistance

Exclusive 24/7 roadside assistance, including:

- Towing, flat-tire change and battery jump starts.
- Out of fuel and lock-out assistance.
- Travel expense reimbursement for lodging, meals and rental car.
- Destination assistance for taxi, shuttle, rental car coverage and emergency transportation.

# Extended Service Plan (ESP)

---

## Transferable Coverage

If you sell your vehicle before your Lincoln Extended Service Plan coverage expires, you can transfer any remaining coverage to the new owner. Whenever you sell your vehicle, prospective buyers may have a higher degree of confidence that vehicle was properly maintained with Lincoln ESP, thereby improving resale value.

## Avoid the Rising Cost of Properly Maintaining Your Vehicle!

Lincoln Extended Service Plan also offers a Premium Maintenance Plan that covers all scheduled maintenance, and select items that routinely wear out. The coverage is prepaid, so you never have to worry about affording your vehicle maintenance. It covers regular checkups, routine inspections, preventive care and replacement of select items that require periodic attention for normal wear:

- Windshield wiper blades.
- Spark plugs (except in California).
- The clutch disc.

- Brake pads and linings.
- Shock absorbers.
- Belts and hoses.
- Diesel exhaust fluid replenishment.

## Interest Free Finance Options Available

Take advantage of our interest free installment payment plan. Just a 10% down payment will provide you with an affordable, no interest, no fee payment program allowing you all the security and benefits Lincoln ESP has to offer while paying over time. You are pre-approved with no credit checks, no hassles! To learn more, call our Lincoln ESP specialists at 800-367-3377.

Complete the information below and mail to:

Ford ESP  
P.O. Box 8072  
Royal Oak, MI 48068-0039

## SERVICE PLANS (CANADA ONLY)

You can get more protection for your vehicle by purchasing a Lincoln Extended Service Plan. Lincoln Extended Service Plan is the only service contract backed by Lincoln Motor Company of Canada, Limited. Depending on the plan you purchase, Lincoln Extended Service Plan provides benefits such as:

- Rental reimbursement.
- Coverage for certain maintenance and wear items.
- Protection against repair costs after your New Vehicle Limited Warranty Coverage expires.
- Roadside Assistance benefits.

## Extended Service Plan (ESP)

---

There are several Lincoln Extended Service Plans available in various time, distance and deductible combinations. Each plan is tailored to fit your own driving needs, including reimbursement for towing and rental. When you purchase Lincoln Extended Service Plan, you receive added peace-of-mind protection throughout Canada and the United States, provided by a network of participating authorized Lincoln Motor Company dealers.

**Note:** *Repairs performed outside of Canada and the United States are not eligible for Lincoln Extended Service Plan coverage.*

This information is subject to change. For more information, visit your local Lincoln of Canada dealer or [www.Lincoln.ca](http://www.Lincoln.ca) to find the Lincoln Extended Service Plan that is right for you.

# Scheduled Maintenance

---

## GENERAL MAINTENANCE INFORMATION

### Why Maintain Your Vehicle?

Carefully following the maintenance schedule helps protect against major repair expenses resulting from neglect or inadequate maintenance and may help to increase the value of your vehicle when you sell or trade it. Keep all receipts for completed maintenance with your vehicle.

We have established regular maintenance intervals for your vehicle based upon rigorous testing. It is important that you have your vehicle serviced at the proper times. These intervals serve two purposes; one is to maintain the reliability of your vehicle and the second is to keep your cost of owning your vehicle down.

It is your responsibility to have all scheduled maintenance performed and to make sure that the materials used meet the specifications identified in this owner's manual. See **Capacities and Specifications** (page 346).

Failure to perform scheduled maintenance invalidates warranty coverage on parts affected by the lack of maintenance.

### Why Maintain Your Vehicle at Your Dealership?

#### Factory-Trained Technicians

Service technicians participate in extensive factory-sponsored certification training to help them become experts on the operation of your vehicle. Ask your dealership about the training and certification their technicians have received.

#### Genuine Ford and Motorcraft® Replacement Parts

Dealerships stock Ford, Motorcraft and Ford-authorized branded re-manufactured replacement parts. These parts meet or exceed our specifications. Parts installed at your dealership carry a nationwide 24-month or unlimited mile (kilometer) parts and labor limited warranty.

If you do not use Ford authorized parts they may not meet our specifications and depending on the part, it could affect emissions compliance.

#### Convenience

Many dealerships have extended evening and Saturday hours to make your service visit more convenient and they offer one stop shopping. They can perform any services that are required on your vehicle, from general maintenance to collision repairs.

**Note:** *Not all dealers have extended hours or body shops. Please contact your dealer for details.*

#### Protecting Your Investment

Maintenance is an investment that pays dividends in the form of improved reliability, durability and resale value. To maintain the proper performance of your vehicle and its emission control systems, make sure you have scheduled maintenance performed at the designated intervals.

# Scheduled Maintenance

---

Your vehicle is equipped with an information display, which indicates the proper oil change interval. This interval may be up to one year or 10000 miles (16000 kilometers).

When **ENGINE OIL CHANGE DUE** or **OIL CHANGE REQUIRED** appears in the information display, it is time for an oil change. Make sure you perform the oil change within two weeks or 500 miles (800 kilometers) of the **ENGINE OIL CHANGE DUE** or **OIL CHANGE REQUIRED** message appearing. Make sure you reset the oil monitoring system after each oil change. See **Engine Oil Check** (page 288).

If your information display resets prematurely, becomes inoperative or the vehicle battery becomes discharged or disconnected, the oil monitoring system resets to 100% oil life. You should change your engine oil one year or 10000 miles (16000 kilometers) from the previous oil change. Never exceed one year or 10000 miles (16000 kilometers) between oil change intervals.

Your vehicle is very sophisticated and built with multiple, complex, performance systems. Every manufacturer develops these systems using different specifications and performance features. That is why it is important to rely upon your dealership to properly diagnose and repair your vehicle.

Ford Motor Company has recommended maintenance intervals for various parts and component systems based upon engineering testing. Ford Motor Company relies upon this testing to determine the most appropriate mileage for replacement of oils and fluids to protect your vehicle at the lowest overall cost to you and recommends against maintenance schedules that deviate from the scheduled maintenance information.

We strongly recommend the use of only genuine Ford, Motorcraft or Ford-authorized re-manufactured replacement parts engineered for your vehicle.

## Additives and Chemicals

This owner's manual and the Ford Workshop Manual list the recommended additives and chemicals for your vehicle. We do not recommend using chemicals or additives not approved by us as part of your vehicle's normal maintenance. Please consult your warranty information.

## Oils, Fluids and Flushing

In many cases, fluid discoloration is a normal operating characteristic and, by itself, does not necessarily indicate a concern or that the fluid needs to be changed. However, a qualified expert, such as the factory-trained technicians at your dealership, should inspect discolored fluids that also show signs of overheating or foreign material contamination immediately.

# Scheduled Maintenance

Make sure to change your vehicle's oils and fluids at the specified intervals or in conjunction with a repair. Flushing is a viable way to change fluid for many vehicle sub-systems during scheduled maintenance.

It is critical that systems are flushed only with new fluid that is the same as that required to fill and operate the system or using a Ford-approved flushing chemical.

## Owner Checks and Services

Make sure you perform the following basic maintenance checks and inspections every month or at six-month intervals.

<b>Check every month</b>
Engine oil level.
Function of all interior and exterior lights.
Tires (including spare) for wear and proper pressure.
Windshield washer fluid level.

<b>Check every six months</b>
Battery connections. Clean if necessary.
Body and door drain holes for obstructions. Clean if necessary.
Cooling system fluid level and coolant strength.
Door weatherstrips for wear. Lubricate if necessary.
Hinges, latches and outside locks for proper operation. Lubricate if necessary.
Parking brake for proper operation.

## Scheduled Maintenance

Check every six months
Safety belts and seat latches for wear and function.
Safety warning lamps (brake, ABS, airbag and safety belt) for operation.
Washer spray and wiper operation. Clean or replace blades as necessary.

### Multi-point Inspection

In order to keep your vehicle running right, it is important to have the systems on your vehicle checked regularly. This can help identify potential issues and prevent major problems. We recommend having the following multi-point inspection performed at every scheduled maintenance interval to help make sure your vehicle keeps running great.

Multi-point inspection	
Accessory drive belt(s)	Hazard warning system operation
Battery performance	Horn operation
Engine air filter	Radiator, cooler, heater and A/C hoses
Exhaust system	Suspension components for leaks or damage

# Scheduled Maintenance

Multi-point inspection	
Exterior lamps operation	Steering and linkage
Fluid levels ; fill if necessary	Tires for wear and proper pressure**
For oil and fluid leaks	Windshield for cracks, chips or pits
Half-shaft dust boots	Washer spray and wiper operation

Brake, coolant recovery reservoir, automatic transmission and window washer

\*\* If your vehicle is equipped with a temporary mobility kit, check the tire sealant expiration Use By date on the canister. Replace as needed.

Be sure to ask your dealership service advisor or technician about the multi-point vehicle inspection. It is a comprehensive way to perform a thorough inspection of your vehicle. Your checklist gives you immediate feedback on the overall condition of your vehicle.

# Scheduled Maintenance

## NORMAL SCHEDULED MAINTENANCE

Normal scheduled maintenance <sup>1,2</sup>	
Every 12 months or 10000 miles (16000 km). The oil monitoring system displays a message in the information display.	Change engine oil and filter. <sup>3</sup>
	Rotate tires, inspect tire wear and measure tread depth.
	Inspect automatic transmission fluid level. Consult dealer for requirements.
	Inspect brake pads, shoes, rotors, drums, brake linings, hoses and parking brake.
	Inspect engine cooling system and motor/electronics cooling system strength and hoses.
	Inspect exhaust system and heat shields.
	Inspect half-shaft boots.
	Inspect steering linkage, ball joints, suspension and tie-rod ends.
Inspect wheels and related components for abnormal noise, wear, looseness or drag.	

<sup>1</sup> Do not exceed one year or 10000 miles (16000 kilometers) between service intervals.

<sup>2</sup> Perform multi-point inspection (recommended).

<sup>3</sup> Reset the oil monitoring system after engine oil and filter changes. See **Engine Oil Check** (page 288).

## Scheduled Maintenance

---

Other maintenance items	
Every 20000 miles (32000 km)	Replace cabin air filter.
Every 30000 miles (48000 km)	Replace engine air filter.
At 100000 miles (160000 km)	Change engine coolant and motor/electronics coolant.**
Every 100000 miles (160000 km)	Replace spark plugs.
Every 150000 miles (240000 km)	Change automatic transmission fluid.

Perform these maintenance items within 3000 miles (4800 kilometers) of the last engine oil and filter change. Do not exceed the designated distance for the interval.

\*\* Initial replacement at six years or 100000 miles (160000 kilometers), then every three years or 50000 miles (80000 kilometers).

## Scheduled Maintenance

### SPECIAL OPERATING CONDITIONS SCHEDULED MAINTENANCE

If you operate your vehicle **primarily** in any of the following conditions, you need to

perform extra maintenance as indicated. If you operate your vehicle **occasionally** under any of these conditions, it is not necessary to perform the extra maintenance. For specific recommendations, see your dealership service advisor or technician.

<b>Extensive idling or low-speed driving for long distances, as in heavy commercial use (such as delivery, taxi, patrol car or livery)</b>	
As required	Change engine oil and filter every 12 months or 10000 miles (16000 km). The oil monitoring system displays a message in the information display. Perform services listed in the Normal Scheduled Maintenance chart.
Inspect frequently, service as required	Replace cabin air filter.
	Replace engine air filter.
Every 60000 miles (96000 km)	Replace spark plugs.

<b>Operating in dusty or sandy conditions (such as unpaved or dusty roads)</b>	
Inspect frequently, service as required	Replace cabin air filter.
	Replace engine air filter.
Every 5000 miles (8000 km)	Inspect the wheels and related components for abnormal noise, wear, looseness or drag.

# Scheduled Maintenance

Operating in dusty or sandy conditions (such as unpaved or dusty roads)	
	Rotate tires, inspect tires for wear and measure tread depth.
Every 5000 miles (8000 km) or six months	Change engine oil and filter.
	Perform multi-point inspection.

## Exceptions

There are several exceptions to the Normal Schedule:

### Axle Maintenance

Change the axle fluid anytime an axle is submerged in water.

### California Fuel Filter Replacement

If you register your vehicle in California, the California Air Resources Board has determined that the failure to perform this maintenance item does not nullify the emission warranty or limit recall liability before the completion of your vehicle's useful life. Ford Motor Company, however, urges you to have all recommended maintenance services performed at the specified intervals and to record all vehicle service.

### Hot Climate Oil Change Intervals

Vehicles operating in the Middle East, North Africa, Sub-Saharan Africa or locations with similar climates using an American Petroleum Institute (API) Certified for Gasoline Engines (Certification mark) oil of SM or SN quality, the normal oil change interval is 3000 miles (5000 kilometers).

If the available API SM or SN oils are not available, then the oil change interval is 1800 miles (3000 kilometers).

# Scheduled Maintenance

---

## Engine Air Filter and Cabin Air Filter Replacement

The life of the engine air filter and cabin air filter is dependent on exposure to dusty and

dirty conditions. Vehicles operated in these conditions require frequent inspection and replacement of the engine air filter and cabin air filter.

## SCHEDULED MAINTENANCE RECORD

<input type="radio"/> Repair Order #:	<p>Dealer stamp</p>
<input type="radio"/> Distance:	
<input type="radio"/> Engine hours (optional):	
<input type="radio"/> Multi-point inspection (recommended): <input type="checkbox"/>	
<input type="radio"/> Signature:	

# Scheduled Maintenance

---

<input type="radio"/> Repair Order #:	<p>Dealer stamp</p>
<input type="radio"/> Distance:	
<input type="radio"/> Engine hours (optional):	
<input type="radio"/> Multi-point inspection (recommended): <input type="checkbox"/>	
<input type="radio"/> Signature:	

<input type="radio"/> Repair Order #:	<p>Dealer stamp</p>
<input type="radio"/> Distance:	
<input type="radio"/> Engine hours (optional):	
<input type="radio"/> Multi-point inspection (recommended): <input type="checkbox"/>	
<input type="radio"/> Signature:	

# Scheduled Maintenance

---

<input type="radio"/> Repair Order #:	<p>Dealer stamp</p>
<input type="radio"/> Distance:	
<input type="radio"/> Engine hours (optional):	
<input type="radio"/> Multi-point inspection (recommended): <input type="checkbox"/>	
<input type="radio"/> Signature:	

<input type="radio"/> Repair Order #:	<p>Dealer stamp</p>
<input type="radio"/> Distance:	
<input type="radio"/> Engine hours (optional):	
<input type="radio"/> Multi-point inspection (recommended): <input type="checkbox"/>	
<input type="radio"/> Signature:	

# Scheduled Maintenance

---

<input type="radio"/> Repair Order #:	<p>Dealer stamp</p>
<input type="radio"/> Distance:	
<input type="radio"/> Engine hours (optional):	
<input type="radio"/> Multi-point inspection (recommended): <input type="checkbox"/>	
<input type="radio"/> Signature:	

<input type="radio"/> Repair Order #:	<p>Dealer stamp</p>
<input type="radio"/> Distance:	
<input type="radio"/> Engine hours (optional):	
<input type="radio"/> Multi-point inspection (recommended): <input type="checkbox"/>	
<input type="radio"/> Signature:	

# Scheduled Maintenance

---

<input type="radio"/> Repair Order #:	<p>Dealer stamp</p>
<input type="radio"/> Distance:	
<input type="radio"/> Engine hours (optional):	
<input type="radio"/> Multi-point inspection (recommended): <input type="checkbox"/>	
<input type="radio"/> Signature:	

<input type="radio"/> Repair Order #:	<p>Dealer stamp</p>
<input type="radio"/> Distance:	
<input type="radio"/> Engine hours (optional):	
<input type="radio"/> Multi-point inspection (recommended): <input type="checkbox"/>	
<input type="radio"/> Signature:	

# Scheduled Maintenance

<input type="radio"/> Repair Order #:	<p>Dealer stamp</p>
<input type="radio"/> Distance:	
<input type="radio"/> Engine hours (optional):	
<input type="radio"/> Multi-point inspection (recommended): <input type="checkbox"/>	
<input type="radio"/> Signature:	

<input type="radio"/> Repair Order #:	<p>Dealer stamp</p>
<input type="radio"/> Distance:	
<input type="radio"/> Engine hours (optional):	
<input type="radio"/> Multi-point inspection (recommended): <input type="checkbox"/>	
<input type="radio"/> Signature:	

# Scheduled Maintenance

---

<input type="radio"/> Repair Order #:	<p>Dealer stamp</p>
<input type="radio"/> Distance:	
<input type="radio"/> Engine hours (optional):	
<input type="radio"/> Multi-point inspection (recommended): <input type="checkbox"/>	
<input type="radio"/> Signature:	

<input type="radio"/> Repair Order #:	<p>Dealer stamp</p>
<input type="radio"/> Distance:	
<input type="radio"/> Engine hours (optional):	
<input type="radio"/> Multi-point inspection (recommended): <input type="checkbox"/>	
<input type="radio"/> Signature:	

# Scheduled Maintenance

---

<input type="radio"/> Repair Order #:	<p>Dealer stamp</p>
<input type="radio"/> Distance:	
<input type="radio"/> Engine hours (optional):	
<input type="radio"/> Multi-point inspection (recommended): <input type="checkbox"/>	
<input type="radio"/> Signature:	

<input type="radio"/> Repair Order #:	<p>Dealer stamp</p>
<input type="radio"/> Distance:	
<input type="radio"/> Engine hours (optional):	
<input type="radio"/> Multi-point inspection (recommended): <input type="checkbox"/>	
<input type="radio"/> Signature:	

# Scheduled Maintenance

---

<input type="radio"/> Repair Order #:	<p>Dealer stamp</p>
<input type="radio"/> Distance:	
<input type="radio"/> Engine hours (optional):	
<input type="radio"/> Multi-point inspection (recommended): <input type="checkbox"/>	
<input type="radio"/> Signature:	

<input type="radio"/> Repair Order #:	<p>Dealer stamp</p>
<input type="radio"/> Distance:	
<input type="radio"/> Engine hours (optional):	
<input type="radio"/> Multi-point inspection (recommended): <input type="checkbox"/>	
<input type="radio"/> Signature:	

# Scheduled Maintenance

<input type="radio"/> Repair Order #:	<p>Dealer stamp</p>
<input type="radio"/> Distance:	
<input type="radio"/> Engine hours (optional):	
<input type="radio"/> Multi-point inspection (recommended): <input type="checkbox"/>	
<input type="radio"/> Signature:	

<input type="radio"/> Repair Order #:	<p>Dealer stamp</p>
<input type="radio"/> Distance:	
<input type="radio"/> Engine hours (optional):	
<input type="radio"/> Multi-point inspection (recommended): <input type="checkbox"/>	
<input type="radio"/> Signature:	

# Scheduled Maintenance

---

<input type="radio"/> Repair Order #:	<p>Dealer stamp</p>
<input type="radio"/> Distance:	
<input type="radio"/> Engine hours (optional):	
<input type="radio"/> Multi-point inspection (recommended): <input type="checkbox"/>	
<input type="radio"/> Signature:	



# Index

<b>A</b>	
A/C	
See: Climate Control.....	139
About This Manual.....	7
Protecting the Environment.....	7
ABS	
See: Brakes.....	192
ABS driving hints	
See: Hints on Driving With Anti-Lock Brakes.....	193
Accessories.....	445
Exterior style.....	445
Interior style.....	445
Lifestyle.....	445
Peace of mind.....	445
Accessories	
See: Replacement Parts Recommendation.....	12
ACC	
See: Using Adaptive Cruise Control.....	213
Active Park Assist.....	203
Automatic Steering into Parking Space.....	205
Deactivating the Park Assist Feature.....	206
Troubleshooting the System.....	206
Using Active Park Assist.....	204
Adaptive Headlamps.....	89
Adjusting the Headlamps.....	297
Horizontal Aim Adjustment.....	299
Vertical Aim Adjustment.....	297
Adjusting the Steering Wheel.....	78
Power Tilt and Telescope Steering Column.....	78
AFS	
See: Adaptive Headlamps.....	89
Airbag Disposal.....	52
Air Conditioning	
See: Climate Control.....	139
Alarm	
See: Anti-Theft Alarm.....	76
Anti-Theft Alarm.....	76
Arming the Alarm.....	77
Disarming the Alarm.....	77
Appendices.....	447
Audible Warnings and Indicators.....	107
Headlamps On Warning Chime.....	107
Key in Ignition Warning Chime.....	107
Keyless Warning Alert.....	107
Parking Brake On Warning Chime.....	108
Audio Control.....	79
Seek, Next or Previous.....	79
Audio System.....	355
General Information.....	355
Audio Unit - Vehicles With: Premium AM/ FM/CD.....	356
Autolamps.....	86
Windshield Wiper Activated Headlamps.....	86
Automatic Climate Control.....	139
Automatic High Beam Control.....	88
Activating the System.....	89
Manually Overriding the System.....	89
Automatic Transmission.....	187
Brake-Shift Interlock Override.....	190
If Your Vehicle Gets Stuck In Mud or Snow.....	190
Push Button Shift Transmission.....	187
Automatic Transmission Fluid	
Check.....	294
Autowipers.....	83
Auxiliary Power Points.....	160
110 Volt AC Power Point.....	160
12 Volt DC Power Point.....	160
Locations.....	160
<b>B</b>	
Blind Spot Information System.....	227
Blind Spot Information System (BLIS®) with Cross Traffic Alert.....	227
Bonnet Lock	
See: Opening and Closing the Hood.....	286
Booster Seats.....	26
Types of Booster Seats.....	26

# Index

Brake Fluid Check.....	294	Child Restraint and Safety Belt Maintenance.....	40	Climate Control.....	139
Brakes.....	192	Child Safety.....	15	Climate Controlled Seats.....	153
General Information.....	192	General Information.....	15	Cooled Seats.....	153
Breaking-In.....	249	Child Safety Locks.....	30	Collision, Damage or Fire Event.....	257
Bulb Specification Chart.....	299	Left-Hand Side.....	31	Guidance for Ford Motor Company Electric and Hybrid-Electric Vehicles Equipped With High Voltage Batteries.....	257
<b>C</b>		Right-Hand Side.....	31	Collision Warning System.....	233
Cabin Air Filter.....	142	Child Seat Positioning.....	28	PRINCIPLE OF OPERATION.....	233
California Proposition 65.....	11	Cleaning Leather Seats.....	307	Coolant Check	
Capacities and Specifications - 2.0L		Cleaning Products.....	302	See: Engine Coolant Check.....	289
Hybrid.....	350	Cleaning the Alloy Wheels.....	308	Crash Sensors and Airbag Indicator.....	51
Specifications.....	351	Cleaning the Engine.....	304	Creating a MyKey.....	60
Capacities and Specifications.....	346	Cleaning the Exterior.....	302	Programming/Changing Configurable Settings.....	60
Car Wash		Cleaning Plastic Exterior Parts.....	303	Cruise Control.....	80
See: Cleaning the Exterior.....	302	Exterior Chrome.....	303	Principle of Operation.....	212
Center Console.....	162	Stripes or Graphics (if equipped).....	303	Type 1.....	80
Changing a Bulb.....	299	Underbody.....	303	Type 2.....	80
Lamp Assembly Condensation.....	299	Cleaning the Instrument Panel and Instrument Cluster Lens.....	306	Cruise control	
Replacing Bulbs.....	299	Cleaning the Interior.....	305	See: Using Cruise Control.....	212
Changing a Fuse.....	284	Cleaning Black Label Interior (If Equipped).....	305	Customer Assistance.....	260
Fuses.....	284	Cleaning the Windows and Wiper Blades.....	304	<b>D</b>	
Changing the 12V Battery.....	295	Clearing All MyKeys.....	60	Data Recording.....	9
Changing the Engine Air Filter.....	301	Climate.....	430	Event Data Recording.....	10
Changing the Wiper Blades.....	297	Climate Control Voice Commands.....	434	Service Data Recording.....	9
Checking MyKey System Status.....	62	Smart Zone Feature.....	433		
Checking the Wiper Blades.....	297				

# Index

Daytime Running Lamps.....87	Electric Parking Brake.....193	Engine Coolant Check.....289
Type 1 - Conventional	Applying the electric parking brake.....193	Adding Coolant.....290
(Non-Configurable).....87	Applying the electric parking brake when the	Adding Engine Coolant.....291
Type 2 - Configurable.....88	vehicle is moving.....194	Adding Inverter System Controller
Direction Indicators.....90	Battery With No Charge.....195	Coolant.....292
Drive Control.....236	Releasing the electric parking brake.....194	Checking the Engine Coolant.....289
LINCOLN DRIVE CONTROL.....236	Electric Vehicle Information.....414	Checking the Inverter System Controller
Driver Alert.....221	Power.....415	Coolant.....290
Using Driver Alert.....221	Emission Control System.....181	Engine Coolant and Inverter System
Driver and Passenger Airbags.....44	On-Board Diagnostics (OBD-II).....182	Controller Coolant.....289
Children and Airbags.....45	Readiness for Inspection/Maintenance (I/M)	Recycled Engine Coolant.....292
Proper Driver and Front Passenger Seating	Testing.....182	Severe Climates.....292
Adjustment.....45	End User License Agreement.....447	What You Should Know About Fail-Safe
Driver and Passenger Knee Airbags.....49	SYNC End User License Agreement	Cooling.....293
Driving Aids.....221	(EULA).....447	Engine Immobilizer
Driving Hints.....249	Engine Block Heater.....166	See: Passive Anti-Theft System.....75
Driving Through Water.....249	Using the Engine Block Heater.....167	Engine Oil Check.....288
DRL		Adding Engine Oil.....288
See: Daytime Running Lamps.....87		Engine Oil Dipstick.....288
<b>E</b>		Engine Specifications.....346
Economical Driving.....249		

# Index

Entertainment.....	385
A/V Inputs.....	405
AM/FM Radio.....	387
Bluetooth Audio.....	405
Browsing Device Content.....	386
CD.....	399
SD Card Slot and USB Port.....	400
Sirius® Satellite Radio (If Activated).....	394
Supported Media Players, Formats and Metadata Information.....	404
EPB	
See: Electric Parking Brake.....	193
Event Data Recording	
See: Data Recording.....	9
Export Unique Options.....	14
Extended Service Plan (ESP).....	465
SERVICE PLANS (CANADA ONLY).....	466
SERVICE PLANS (U.S. Only).....	465
Exterior Mirrors.....	94
Auto-Dimming Feature.....	95
Blind Spot Monitor.....	96
Fold-Away Exterior Mirrors.....	95
Heated Exterior Mirrors.....	95
Integrated Blind Spot Mirrors.....	96
Memory Mirrors.....	95
Power Exterior Mirrors.....	94
Power-Folding Mirrors.....	95
Signal Indicator Mirrors.....	95

## F

Fastening the Safety Belts.....	33
Rear Inflatable Safety Belt.....	35
Safety Belt Extension Assembly.....	36
Safety Belt Locking Modes.....	34
Using Safety Belts During Pregnancy.....	33
Flat Tire Inflation	
See: Temporary Mobility Kit.....	311
Floor Mats.....	250
Front Passenger Sensing System.....	45
Fuel and Refueling.....	174
Fuel Consumption.....	180
Calculating Fuel Economy.....	180
Filling the Tank.....	180
Fuel Filter.....	295
Fuel Quality.....	175
Choosing the Right Fuel.....	175
Octane Recommendations.....	175
Fuel Shutoff.....	253
Fuses.....	267
Fuse Specification Chart.....	267
Passenger Compartment Fuse Panel.....	278
Power Distribution Box.....	267

## G

Garage Door Opener	
See: Universal Garage Door Opener.....	155
Gauges.....	100
Left Information Display.....	101
Right Information Display.....	103
General Information on Radio	
Frequencies.....	53
Intelligent Access.....	53
General Maintenance Information.....	468
Multi-point Inspection.....	471
Owner Checks and Services.....	470
Protecting Your Investment.....	468
Why Maintain Your Vehicle?.....	468
Why Maintain Your Vehicle at Your Dealership?.....	468
Getting Assistance Outside the U.S. and Canada.....	263
Getting the Services You Need.....	260
Away From Home.....	260
Global Opening and Closing.....	94
Closing the Windows.....	94
Opening the Windows.....	94

## H

Hazard Warning Flashers.....	253
------------------------------	-----

# Index

---

Headlamp Exit Delay.....	87
Head Restraints.....	144
Adjusting the Head Restraint.....	145
Tilting Head Restraints .....	146
Heated Seats.....	151
Rear Heated Seats.....	152
Heated Steering Wheel.....	81
Heated Windows and Mirrors.....	142
Heated Exterior Mirror.....	142
Heated Rear Window.....	142
Heating	
See: Climate Control.....	139
HEV	
See: Hybrid Electric Vehicle.....	168
High Voltage Battery Cut-Off Switch.....	185
High Voltage Battery.....	184
General Information.....	184
Hill Start Assist.....	195
Using Hill Start Assist.....	196
Hints on Controlling the Interior	
Climate.....	141
Cooling the Interior Quickly.....	141
General Hints.....	141
Heating the Interior Quickly.....	141
Recommended Settings for Cooling .....	141
Recommended Settings for Heating.....	141
Side Window Defogging in Cold Weather.....	141
Hints on Driving With Anti-Lock Brakes.....	193
Hood Lock	
See: Opening and Closing the Hood.....	286
Hybrid Electric Vehicle.....	168
<b>I</b>	
In California (U.S. Only).....	261
Information Display Control.....	80
Cluster Display Control Features.....	80
Information Displays.....	109
General Information.....	109
Information.....	419
911 Assist.....	427
Alerts.....	426
Calendar.....	426
Sirius Travel Link.....	424
SYNC Services (If Equipped, United States Only).....	420
Vehicle Health Report.....	429

# Index

Information Messages.....	120
Active Park.....	121
Adaptive Cruise Control.....	121
AdvanceTrac™.....	122
Airbag.....	122
Alarm.....	123
Automatic Engine Shutdown.....	123
Battery and Charging System (12 volt).....	124
Battery and Charging System (High Voltage).....	124
Blind Spot Information and Cross Traffic Alert System.....	125
Doors and Locks.....	125
Driver Alert.....	126
Fuel.....	126
Hill Start Assist.....	127
Keys and Intelligent Access.....	127
Lane Keeping System.....	128
Maintenance.....	129
MyKey.....	130
Park Aid.....	131
Park Brake.....	132
Power Steering.....	133
Pre-Collision Assist.....	133
Remote Start.....	134
Seats.....	134
Starting System.....	134
Tire Pressure Monitoring System.....	135

Traction Control.....	135
Transmission.....	136
Installing Child Seats.....	17
Child Seats.....	17
Using Lap and Shoulder Belts.....	17
Using Lower Anchors and Tethers for Children (LATCH).....	23
Using Tether Straps.....	24
Instrument Cluster.....	100
Instrument Lighting Dimmer.....	86
Interior Lamps.....	90
Front Interior Lamp.....	91
Rear Interior Lamp.....	91
Rear Interior Lamp (If Equipped).....	92
Interior Luggage Compartment Release.....	73
Interior Mirror.....	96
Auto-Dimming Mirror.....	97
Introduction.....	7

## J

Jump Starting the Vehicle.....	254
Connecting the Jumper Cables.....	254
Jump Starting.....	256
Preparing Your Vehicle.....	254
Removing the Jumper Cables.....	256

## K

Keyless Entry.....	70
SECURICODE™ KEYLESS ENTRY KEYPAD.....	70
Keyless Starting.....	163
Ignition Modes.....	163
Keys and Remote Controls.....	53

## L

Lane Keeping System.....	222
Switching the System On and Off.....	222
Lighting Control.....	85
Headlamp Flasher.....	85
High Beams.....	85
Lighting.....	85
Lincoln Automotive Financial Services.....	12
Load Carrying.....	238
Load Limit.....	238
Vehicle Loading - with and without a Trailer.....	238

# Index

Locking and Unlocking.....	65
Activating Intelligent Access .....	66
Autolock Feature.....	67
Auto Relock.....	67
Battery Saver.....	68
Illuminated Entry.....	68
Illuminated Exit.....	68
Luggage Compartment.....	68
Power Decklid (If Equipped).....	69
Power Door Locks.....	65
Remote Control.....	65
Smart Unlocks .....	67
Locks.....	65

## M

Maintenance.....	285
General Information.....	285
Media Hub.....	358
Memory Function.....	149
Easy Entry and Exit Feature.....	150
Linking a PreSet Position to your Remote Control or Intelligent Access Key Fob.....	150
Saving a PreSet Position.....	149
Message Center	
See: Information Displays.....	109

Mirrors	
See: Heated Windows and Mirrors.....	142
See: Windows and Mirrors.....	93
Mobile Communications Equipment.....	13
Moonroof.....	98
Bounce-Back.....	99
Opening and Closing the Moonroof.....	98
Retractable Panoramic Roof.....	99
Venting the Moonroof.....	99
Motorcraft Parts.....	347
MyKey Troubleshooting.....	63
MyKey™ .....	59
Principle of Operation.....	59
MyLincoln Touch™ .....	359
General Information.....	359

## N

Navigation.....	435
cityseekr.....	437
Map Mode.....	439
Navigation Map Updates.....	442
Navigation Voice Commands.....	442
Point of Interest (POI) Categories.....	436
Quick-touch Buttons.....	441
Setting a Destination.....	435
Setting Your Navigation Preferences.....	438
Normal Scheduled Maintenance.....	473

## O

Oil Check	
See: Engine Oil Check.....	288
Opening and Closing the Hood.....	286
Ordering Additional Owner's Literature.....	265
Obtaining a French Owner's Manual.....	265
Overhead Console.....	162

## P

Parking Aid.....	201
Front Sensing System.....	202
Rear Sensing System.....	202
Parking Aids.....	201
Passive Anti-Theft System.....	75
SecuriLock.....	75
PATS	
See: Passive Anti-Theft System.....	75
Perchlorate.....	12
Personal Safety System™ .....	42
How Does the Personal Safety System Work?.....	42

# Index

Phone.....	407
Making Calls.....	409
Pairing Subsequent Phones.....	409
Pairing Your Phone for the First Time.....	408
Phone Menu Options.....	410
Phone Settings.....	412
Phone Voice Commands.....	413
Receiving Calls.....	410
Text Messaging.....	411
Post-Crash Alert System.....	259
Spinout Detection.....	259
Power Door Locks	
See: Locking and Unlocking.....	65
Power Seats.....	146
Multi-Contour Front Seats With Active Motion	
.....	148
Power Lumbar.....	148
Power Steering Fluid Check.....	294
Power Windows.....	93
Accessory Delay.....	94
Bounce-Back.....	93
One-Touch Down.....	93
One-Touch Up.....	93
Window Lock.....	94

## R

Rear Seat Armrest.....	154
Armrest pass-through.....	154
Rear Seats.....	150
Rear View Camera.....	208
Using the Rear View Camera System.....	209
Rear View Camera	
See: Rear View Camera.....	208
Refueling.....	178
Easy Fuel™ Capless Fuel System.....	178
Remote Control.....	54
Car Finder.....	56
Intelligent Access Key.....	54
Remote Start.....	56
Replacing the Battery.....	55
Sounding a Panic Alarm.....	56
Remote Start.....	143
Automatic Settings.....	143
Repairing Minor Paint Damage.....	308
Replacement Parts Recommendation.....	12
Collision Repairs.....	12
Scheduled Maintenance and Mechanical	
Repairs.....	12
Warranty on Replacement Parts.....	13
Replacing a Lost Key or Remote	
Control.....	58

Reporting Safety Defects (Canada	
Only).....	266
Reporting Safety Defects (U.S. Only).....	265
Roadside Assistance.....	252
Vehicles Sold In Canada: Getting Roadside	
Assistance.....	253
Vehicles Sold In Canada: Using Roadside	
Assistance.....	253
Vehicles Sold In the United States: Getting	
Roadside Assistance.....	252
Vehicles Sold In the United States: Using	
Roadside Assistance.....	252
Roadside Emergencies.....	252
Running-In	
See: Breaking-In.....	249
Running Out of Fuel.....	175
Refilling With a Portable Fuel Container.....	176

## S

Safety Belt Height Adjustment.....	37
Safety Belt Minder.....	38
Belt-Minder™.....	38
Safety Belts.....	32
Principle of Operation.....	32
Safety Belt Warning Lamp and Indicator	
Chime.....	37
Conditions of operation.....	38

# Index

Safety Precautions.....	174	Starting a Gasoline Engine.....	164	Temporary Mobility Kit.....	311
Scheduled Maintenance Record.....	477	Automatic Shutdown.....	165	First Stage: Reinflating the Tire with Sealing Compound and Air.....	313
Scheduled Maintenance.....	468	Fast Restart.....	165	General Information.....	311
Seats.....	144	Guarding Against Exhaust Fumes.....	166	Second Stage: Checking Tire Pressure.....	314
Security.....	75	Important Ventilating Information.....	166	Tips for Use of the Kit.....	312
Settings.....	372	Switching Off the Vehicle When It Is Moving.....	166	Type 1.....	311
Clock.....	373	Switching Off the Vehicle When It Is Stationary.....	166	Type 2.....	317
Display.....	373	Starting and Stopping the Engine.....	163	What to do after the Tire has been Sealed.....	315
Settings.....	375	General Information.....	163	What to do when a Tire Is Punctured.....	313
Sound.....	374	Steering.....	232	The Better Business Bureau (BBB) Auto Line Program (U.S. Only).....	262
Vehicle.....	374	Electric Power Steering.....	232	Tire Care.....	324
Side Airbags.....	48	Steering Wheel.....	78	Glossary of Tire Terminology.....	326
Side Curtain Airbags.....	49	Storage Compartments.....	162	Information About Uniform Tire Quality Grading.....	324
Sitting in the Correct Position.....	144	Sunroof		Information Contained on the Tire	
Snow Chains		See: Moonroof.....	98	Sidewall.....	327
See: Using Snow Chains.....	338	Sun Shades.....	97	Temperature A B C.....	325
Special Notices.....	13	Sun Visors.....	97	Traction AA A B C.....	325
New Vehicle Limited Warranty.....	13	Illuminated Vanity Mirror.....	97	Treadwear.....	325
Special Instructions.....	13	Supplementary Restraints System.....	43	Tire Inflation When Punctured	
Special Operating Conditions Scheduled Maintenance.....	475	Principle of Operation.....	43	See: Temporary Mobility Kit.....	311
Exceptions.....	476	Symbols Glossary.....	7		
Speed Control					
See: Cruise Control.....	212				
Stability Control.....	199				
Principle of Operation.....	199				

## T

### Technical Specifications

  See: Capacities and Specifications.....346

# Index

Tire Pressure Monitoring System.....	339	Using Adaptive Cruise Control.....	213	Using Traction Control.....	197
Changing Tires with a Tire Pressure		Blocked Sensor.....	218	Switching the System Off Using a	
Monitoring System.....	340	Changing the Set Speed.....	217	Switch.....	197
Understanding Your Tire Pressure Monitoring		Detection Issues.....	217	Switching the System Off Using the	
System .....	340	Disengaging the System.....	216	Information Display Controls.....	197
Tire Repair Kit		ECO Cruise Control.....	220	System Indicator Lights and Messages.....	197
See: Temporary Mobility Kit.....	311	Following a Vehicle.....	214	Utilizing the Mediation/Arbitration Program	
Tires		Hilly Condition Usage.....	217	(Canada Only).....	263
See: Wheels and Tires.....	311	Low Speed Automatic Cancellation.....	217	<b>V</b>	
Towing a Trailer.....	247	Overriding the System.....	216	Vehicle Care.....	302
Towing the Vehicle on Four Wheels.....	248	Resuming the Set Speed.....	217	General Information.....	302
Emergency Towing.....	248	Setting a Speed.....	214	Vehicle Certification Label.....	348
Recreational Towing.....	248	Setting the Gap Distance.....	215	Vehicle Identification Number.....	348
Towing.....	247	Switching the System Off.....	217	Vehicle Storage.....	308
Traction Control.....	197	Switching the System On.....	214	Battery.....	309
Principle of Operation.....	197	Switching to Normal Cruise Control.....	220	Body.....	309
Transmission Code Designation.....	349	System Not Available.....	218	Brakes.....	309
Transmission.....	187	Using Cruise Control.....	212	Cooling system.....	309
Transmission		ECO Cruise Control.....	213	Engine.....	309
See: Transmission.....	187	Switching Cruise Control Off.....	213	Fuel system.....	309
Transporting the Vehicle.....	247	Switching Cruise Control On.....	212	General.....	309
<b>U</b>		Using MyKey With Remote Start		Miscellaneous.....	310
Under Hood Overview.....	286	Systems.....	63	Removing Vehicle From Storage.....	310
Unique Driving Characteristics.....	168	Using Snow Chains.....	338	Tires.....	309
Universal Garage Door Opener.....	155	Using Stability Control.....	200	Ventilation	
HomeLink Wireless Control System.....	155	AdvanceTrac® .....	200	See: Climate Control.....	139

# Index

---

## VIN

See: Vehicle Identification Number.....348

Voice Control.....80

# Index

---

## W

Warning Lamps and Indicators.....	103
Adaptive Cruise Control.....	103
Anti-Lock Braking System.....	104
Battery.....	104
Blind Spot Monitor.....	104
Brake System.....	104
Cruise Control.....	104
Direction Indicator.....	104
Door Ajar.....	105
Electric Park Brake.....	105
Engine Oil.....	105
Engine or Motor Coolant Temperature.....	105
Fasten Safety Belt.....	105
Front Airbag.....	105
Grade Assist.....	105
Heads Up Display.....	105
High Beam.....	105
Hood Ajar.....	105
Lane Keeping Aid.....	105
Low Fuel Level.....	106
Low Tire Pressure Warning.....	106
Low Washer Fluid.....	106
Parking Lamps.....	106
Powertrain Fault.....	106
Ready to Drive.....	106
Service Engine Soon.....	106
Stability Control.....	107
Stability Control Off.....	107
Stop Safely.....	107
Trunk Ajar.....	107
Washer Fluid Check.....	294
Washers	
See: Cleaning the Exterior.....	302
See: Wipers and Washers.....	82
Waxing.....	303
Wheels and Tires.....	311
Technical Specifications.....	344
Windows and Mirrors.....	93
Windshield Washers.....	84
Windshield Wipers.....	82
Intermittent Wipe.....	82
Speed Dependent Wipers.....	82
Wipers and Washers.....	82

