



LCD TV

OWNER'S MANUAL

MODEL: 20HIZ20
20LS1R*



Please read **Information Manual** included together before reading this manual and operating your set.

Retain it for future reference.

Record model number and serial number of the set.

See the label attached on the back cover and quote this information to your dealer when you require service.

Contents

Installation	3
Location and function of controls	7
Remote control handset	
Battery installation / Front / Rear	
Basic operation	11
On and off	
On-Screen Menu Language/Country Selection	
On screen menus	12
Menu selection / Programme selection	
Volume adjustment	
Setting up TV stations	13
Auto programme tuning	
Manual programme tuning	
Programme edit / Favourite programme	
Calling the programme table	
Picture adjustment	18
PSM (Picture Status Memory)	
Picture adjustment	
CSM (Colour Status Memory)	
XD function / Cinema / Reset	
Sound adjustment	22
SSM (Sound Status Memory)	
Sound adjustment / Stereo/Dual reception	
NICAM reception / Sound output selection	
Time Menu	24
Clock / On/Off time	
Auto sleep / Sleep timer	
Other functions	26
Child lock / XD Demo	
TV, AV and PC modes / Auto AV switching	
Teletext	29
Switch on/off	
SIMPLE text / TOP text	
FASTEXT / Special teletext functions	
Connection of external equipment	31
Aerial socket / Euro scart socket (VCR)	
Audio/Video in sockets	
S-Video/Audio in sockets (S-Video)	
DVD input sockets / DTV in sockets	
Headphone socket	
Picture format	33
External Control Device Setup ; RS-232C	34
Troubleshooting checklist	42
Product Specifications	44

Installation

Stand Installation

1. Assemble parts of stand body with cover base of the stand. Insert stand body into a cover base until clicking sound.
2. Carefully place the product screen side down on a cushioned surface that will protect product and screen from damage.
3. Place the product stand on the product as shown.

Note: Here shown may be somewhat different from your set.

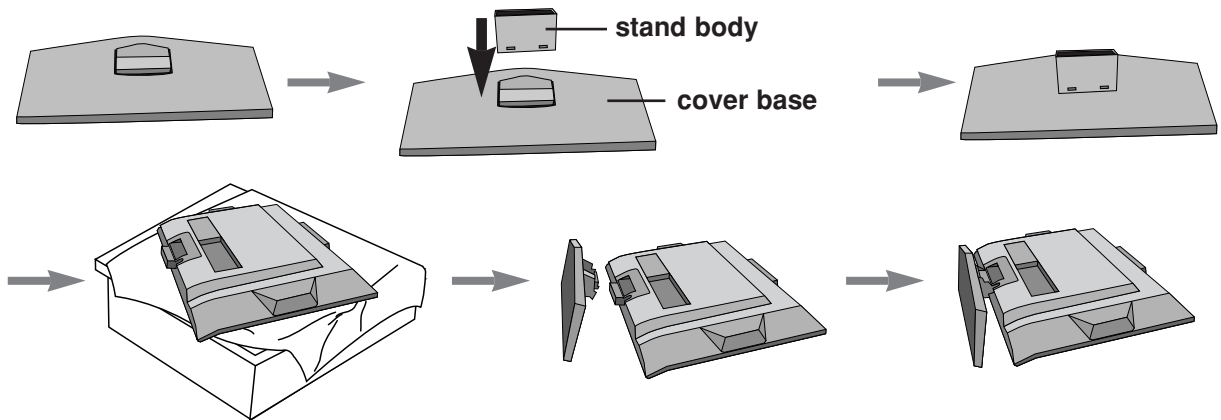

Detaching stand

1. Place the set with its front facing downward on a cushion or soft cloth.
2. Hold the stand with both hands and bend it upward.
3. Pull each side of cover base backward during pressing latch upward.
4. Hold cover base and pull with shake it backward to separate from stand body.
5. Pull stand body to separate from set during pressing 2 latches.

Note: Here shown may be somewhat different from your set.

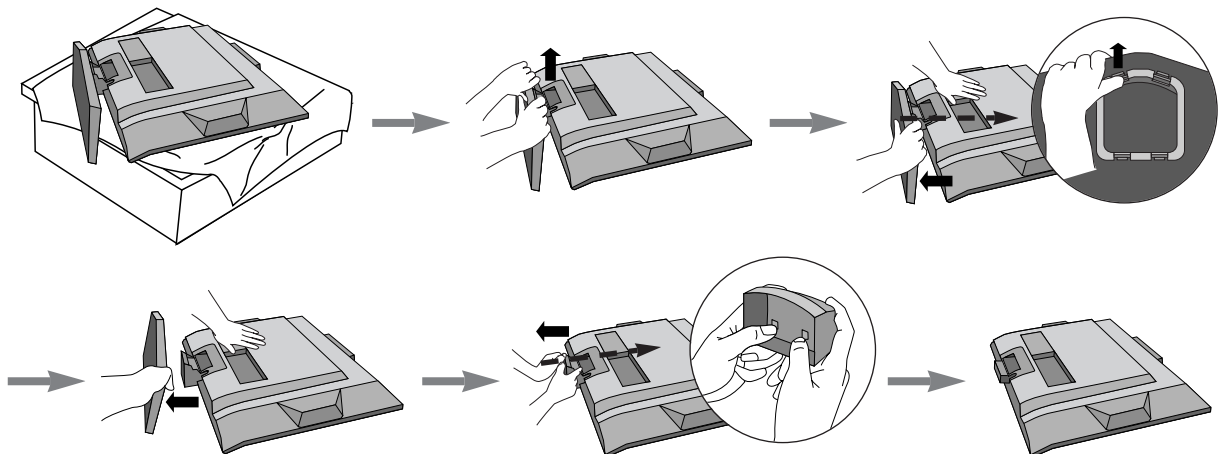

Installation

Connection of TV

1. Connect the aerial cable to the socket marked **ANTENNA IN** on the back. For the best reception an outdoor aerial should be used.
2. To connect an additional equipment, see the **Connection of external equipment** section.
3. Connect the power cord.

Note: Here shown may be somewhat different from your set.

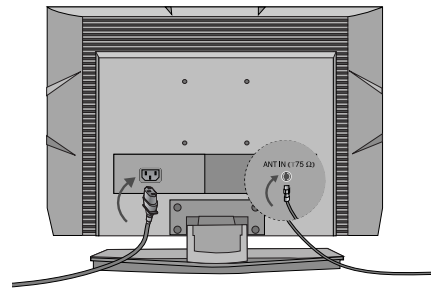

Basic connection

1. Connect the cables as necessary.
To connect an additional equipment, see the **Connection of external equipment** section.
2. Install the **Cable management** as shown.

Note: Here shown may be somewhat different from your set.

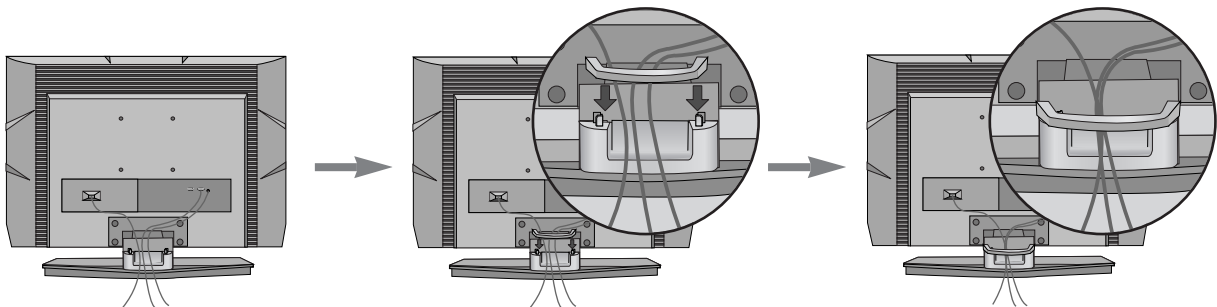

How to remove the Cable management

First, press the cable management.

Hold the **Cable management** with both hands and pull it upward.

Note: Do not hold the **CABLE MANAGEMENT** when moving the product. (If the product is dropped, you may be injured or the product may be broken.)

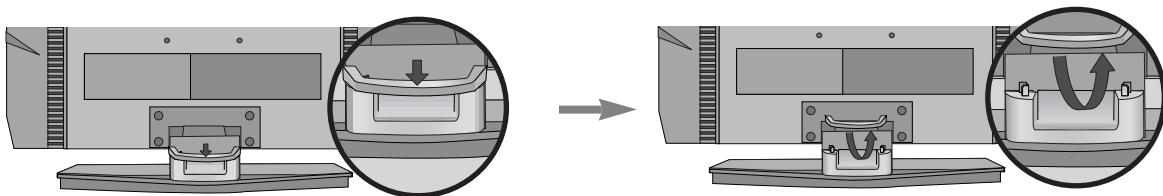

Installation

Wall Mount: Horizontal installation

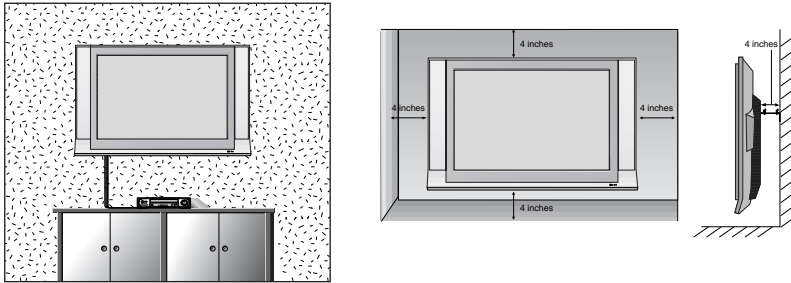

For proper ventilation, allow a clearance of 4" on each side and from the wall. Detailed installation instructions are available from your dealer, see the optional Tilt Wall Mounting Bracket Installation and Setup Guide.

Desktop Pedestal Installation

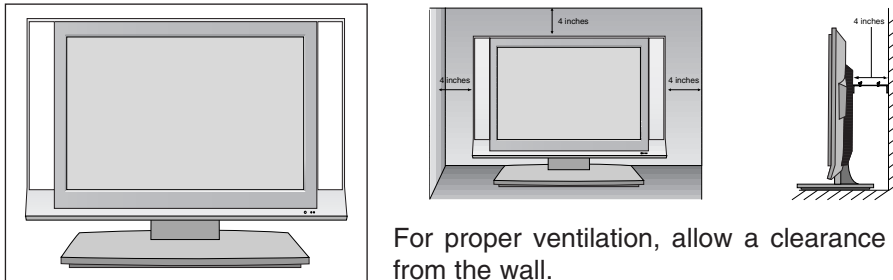

For proper ventilation, allow a clearance of 4" on each side and from the wall.

Installation

Positioning your display

Adjust the position of the panel in various ways for maximum comfort.

• Tilt range

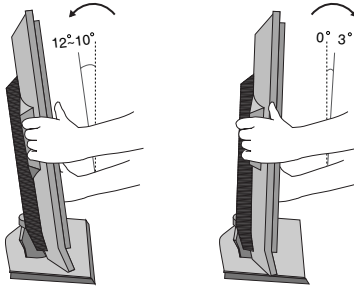

Location

Position your set so that no bright light or sunlight falls directly onto the screen. Care should be taken not to expose the set to any unnecessary vibration, moisture, dust or heat. Also ensure that the set is placed in a position to allow a free flow of air. Do not cover the ventilation openings on the back cover. If you intend to mount the TV to a wall, attach VESA standard mounting interface (optional parts) to the back of the TV.

When you install the set to use the wall mounting bracket (optional parts), fix it carefully so as not to drop.

Kensington Security System

- The TV is equipped with a Kensington Security System connector on the back panel. Connect the Kensington Security System cable as shown below.
- For the detailed installation and use of the Kensington Security System, refer to the user's guide provided with the Kensington Security System.
For further information, contact <http://www.kensington.com>, the internet homepage of the Kensington company. Kensington sells security systems for expensive electronic equipment such as notebook PCs and LCD projectors.

Note:

- *The Kensington Security System is an optional accessory.*

Note:

- If the TV feels cold to the touch, there may be a small "flicker" when when it is turned on. This is normal, there is nothing wrong with TV.*
- Some minute dot defects may be visible on the screen, appearing as tiny red, green, or blue spots. However, they have no adverse effect on the monitor's performance.*
- Avoid touching the LCD screen or holding your finger(s) against it for long periods of time. Doing so may produce some temporary distortion effects on the screen.*

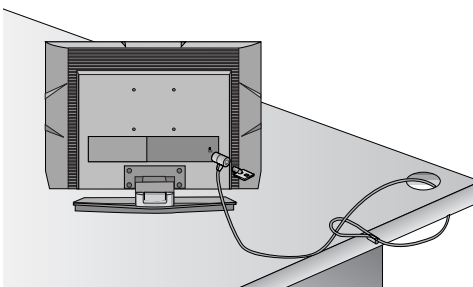

Location and function of controls

All the functions can be controlled with the remote control handset. Some functions can also be adjusted with the buttons on the top panel of the set. Only the remote control handset supplied will operate this set.

Remote control handset

Before you use the remote control handset, please install the batteries. See the next page.

1. **POWER**
switches the set on from standby or off to standby.
2. **NUMBER BUTTONS**
switches the set on from standby and selects a programme.
3. **LIST**
displays the programme table.
4. **PSM (Picture Status Memory)**
recalls your preferred picture setting.
5. **MUTE**
switches the sound on or off.
Press the **MUTE** button. The sound is switched off and the display  appears.
You can cancel it by pressing the **MUTE**, **◀ / ▶**, **I/II**, or **SSM** button.
6. **▲ / ▼ (Programme Up/Down)**
selects a programme or a menu item.
switches the set on from standby.
◀ / ▶ (Volume Down/Up)
adjusts the volume.
adjusts menu settings.
OK
accepts your selection or displays the current mode.
7. **MENU**
selects a menu.
8. **SLEEP**
sets the sleep timer.

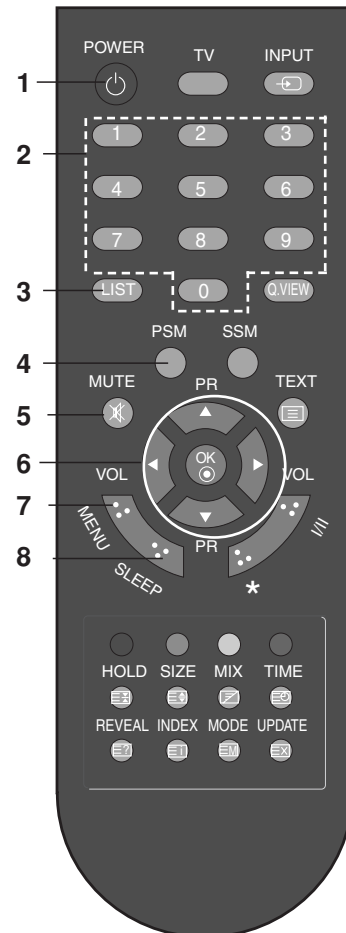

Location and function of controls

- 9. **TV**
returns to the TV mode.
switches the set on from standby.
- 10. **INPUT**
selects the remote operating mode.
switches the set on from standby.
- 11. **Q.VIEW**
returns to the previously viewed programme.
Press the **Q.VIEW** button to view the last programme you were watching.
- 12. **SSM (Sound Status Memory)**
recalls your preferred sound setting.
- 13. **TELETEXT BUTTONS**
These buttons are used for teletext.
For further details, see the 'Teletext' section.
- 14. **I/II**
selects the language during dual language broadcast.
- 15. **COLOURED BUTTONS** : These buttons are used for teletext (only TELETEXT models) or programme edit.

* : No function

Battery installation

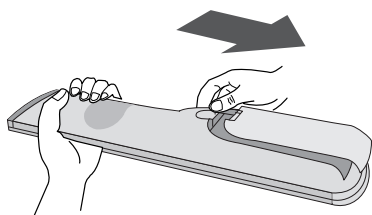

The remote control handset is powered by two AAA batteries. To load the batteries, turn the remote control handset over and open the battery compartment. Install two batteries as indicated by the polarity symbols (+ and -) marked inside the compartment.

Note : To avoid damage from possible battery leakage, remove the batteries if you do not plan to use the remote control handset for an extended period of time.

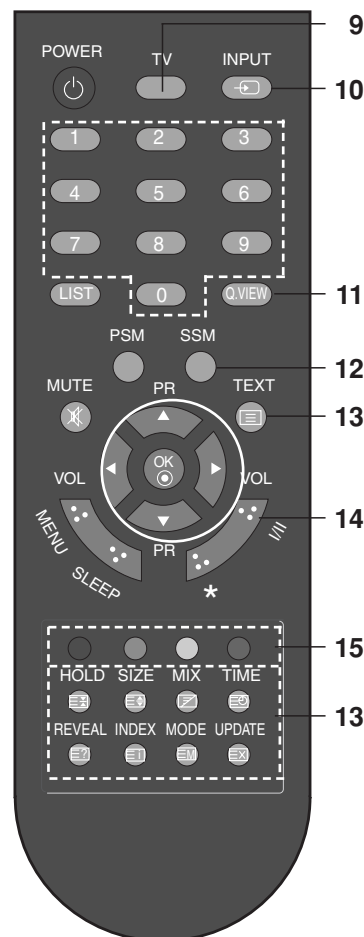

Location and function of controls

Front

Top panel

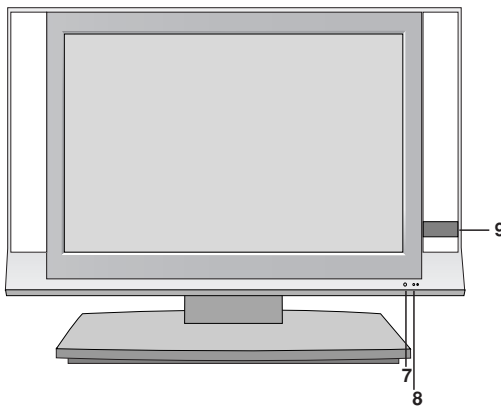
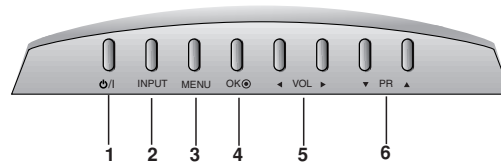

1. **ON/OFF (⏻ / I)**
switches the set on from standby or off to standby.
2. **INPUT**
selects the remote operating mode.
switches the set on from standby.
3. **MENU**
selects a menu.
4. **OK**
accepts your selection or displays the current mode.
5. **◀ / ▶ (Volume Down/Up)**
adjusts the volume.
adjusts menu settings.
6. **▼ / ▲ (Programme Down/Up)**
selects a programme or a menu item.
switches the set on from standby.
7. **REMOTE CONTROL SENSOR**
8. **POWER/STANDBY INDICATOR**
illuminates red in standby mode.
illuminates green when the set is switched on.
9. **Clock**
displays the clock.

Location and function of controls

Rear

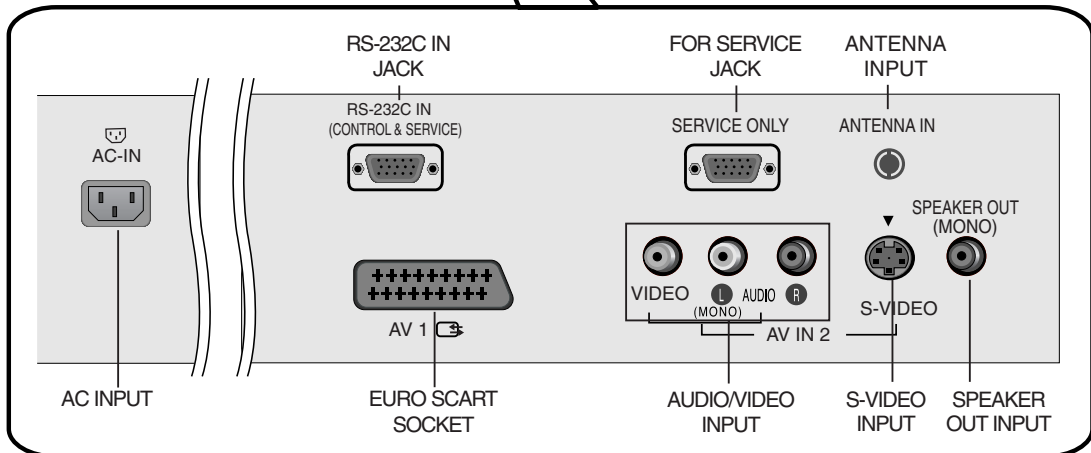
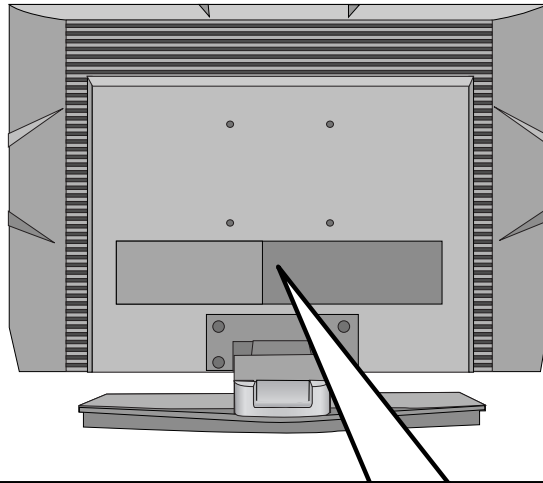

Basic operation

On and off

1. Press the **POWER**, **▲ / ▼**, **TV**, **INPUT** or **NUMBER** buttons to switch it on fully.
2. Press the **POWER** button. The set reverts to standby mode.
3. Pull out mains plugs to switch the set off.

Note : If, while the set is switched on, the mains plug is disconnected the set will switch to standby or power on when the mains plug is replaced in the mains power socket.

On-Screen Menu Language / Country Selection

Installation guide menu appears on TV screen when it is turned on for the first time.

1. Press the **▲ / ▼ / ◀ / ▶** button and then, **OK** button to select your desired language.
2. Press the **▲ / ▼ / ◀ / ▶** button and then, **OK** button to select your country.

* If you want to change Language/ Country selection

1. Press the **MENU** button and then **▲ / ▼** button to select the **SPECIAL** menu.
2. Press the **▶** button and then **▲ / ▼** button to select **Language**.
The menus can be shown on the screen in the selected language.
Or, Press the **▶** button and then **▲ / ▼** button to select **Country**.
3. Press the **▶** button and then **▲ / ▼ / ◀ / ▶** button to select your desired language or country.
4. Press the **OK** button.
5. Repeatedly press the **MENU** button to return to normal TV viewing.

Note:

- a. If you don't finish set up **Installation Guide** by pressing **MENU** button or time out of **OSD (On Screen Display)** display, it will continuously appear until completing set up whenever the set is turned on.
- b. If you select wrong local country, the teletext may not appear correctly on the screen and some problem may happen during teletext operation.
- c. Hebrew is added to **Country of Installation Guide** according to the countries which using Hebrew languages.

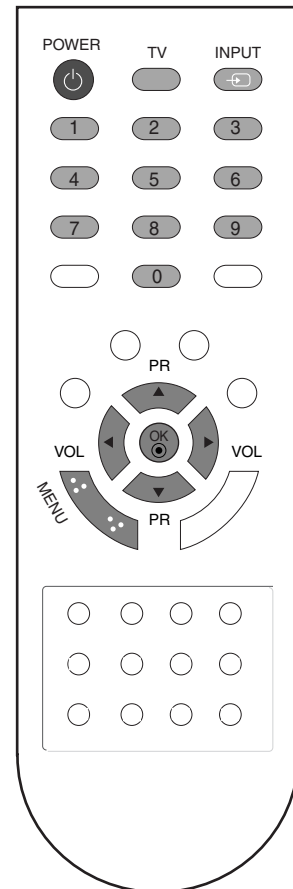

On screen menus

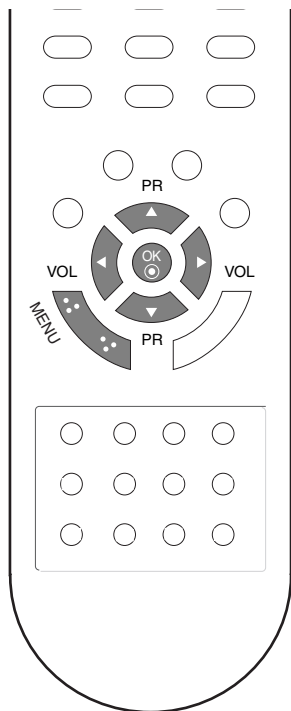

Menu selection

1. Press the **MENU** button and then **▲ / ▼** button to display each menu.
2. Press the **▶** button and then **▲ / ▼** button to select a menu item.
3. Change the setting of an item in the sub or pull-down menu with **◀ / ▶** button.

You can move to the higher level menu by pressing the **OK** button and to move to the lower level menu by pressing the **MENU** button.

Note :

- a. In the teletext mode, menus are not displayed.

Programme selection

You can select a programme number with the **▲ / ▼** or **NUMBER** buttons.

Volume adjustment

Press the **◀ / ▶** button to adjust the volume.



STATION menu

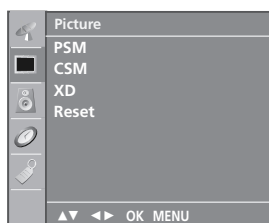

PICTURE menu



SOUND menu



SPECIAL menu

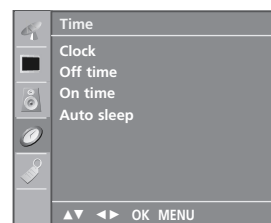

TIME menu

Setting up TV stations

Up to 100 TV stations can be stored by programme numbers (0 to 99). Once you have preset the stations, you will be able to use the ▲ / ▼ or NUMBER buttons to scan the stations you have programmed. Stations can be tuned using automatic or manual modes.

Auto programme tuning

All stations that can be received are stored by this method. It is recommended that you use auto programme during installation of this set.

1. Press the **MENU** button and then ▲ / ▼ button to select the **Station** menu.
2. Press the ► button and then ▲ / ▼ button to select **Auto programme**.



3. Press the ► button. Select a TV system with the ► button and then ▲ / ▼ button on the **System** menu;
 - BG** : PAL B/G, SECAM B/G (Europe/East Europe)
 - I** : PAL I/II (U.K./Ireland)
 - DK** : PAL D/K, SECAM D/K (East Europe)
 - L** : SECAM L/L' (France)
4. Press the **OK** button.
5. Press the ▲ / ▼ button to select **Storage from**.
6. Select the beginning programme number with the ◀ / ▶ button or NUMBER buttons on the **Storage from** pull-down menu. Any number under 10 is entered with a numeric '0' in front of it, i.e. '05' for 5.
7. Press the **OK** button.
8. Press the ▲ / ▼ button to select **Search**.

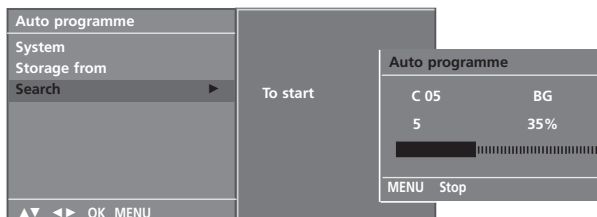

9. Press the ► button to begin auto programming. All receivable stations are stored. To stop auto programming, press the **MENU** button. When auto programming is completed, the **Programme edit** menu appears on the screen. See the 'Programme edit' section to edit the stored programme.
10. Repeatedly press the **MENU** button to return to normal TV viewing.

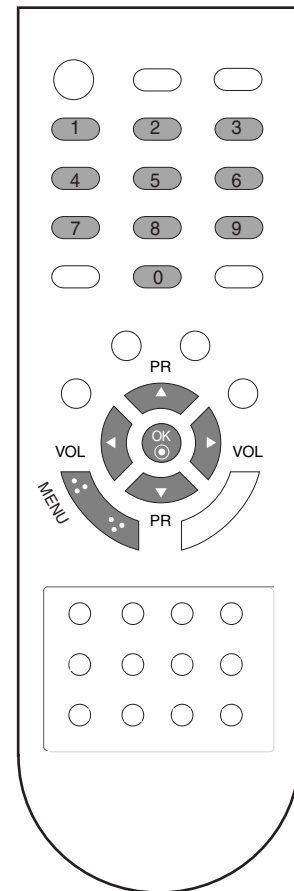

Setting up TV stations



Manual programme tuning

Manual programme lets you manually tune and arrange the stations in whatever order you desire. Also you can assign a station name with five characters to each programme number.

1. Press the **MENU** button and then **▲ / ▼** button to select the **Station** menu.
2. Press the **▶** button and then **▲ / ▼** button to select **Manual programme**.
3. Press the **▶** button and then **▲ / ▼** button to select **Storage**.

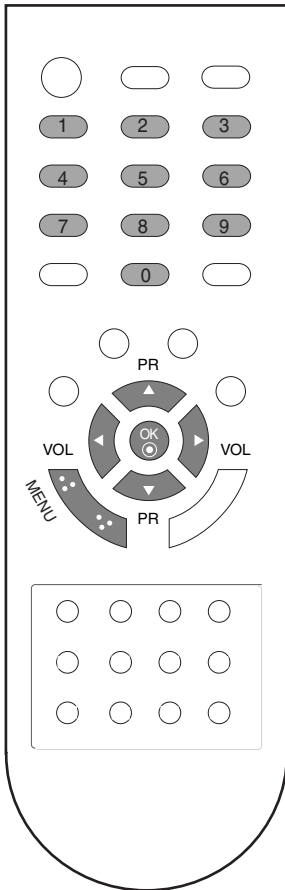

4. Select the desired programme number (0 to 99) with the **◀ / ▶** button or **NUMBER** buttons on the **Storage** menu. Any number under 10 is entered with a numeric '0' in front of it, i.e. '05' for 5.
5. Press the **OK** button.
6. Press the **▲ / ▼** button to select **System**.
7. Select a TV system with the **▶** button and then **◀ / ▶** button on the **System** menu;
 - BG** : PAL B/G, SECAM B/G (Europe/East Europe)
 - I** : PAL I/II (U.K./Ireland)
 - DK** : PAL D/K, SECAM D/K (East Europe)
 - L** : SECAM L/L' (France)
8. Press the **OK** button.
9. Press the **▲ / ▼** button to select **Band**.
10. Press the **▶** button and then **▲ / ▼** button to select **VHF/UHF** or **Cable** on the **Band** menu.
11. Press the **OK** button.
12. Press the **▲ / ▼** button to select **Channel**.
13. Select the desired programme with **◀ / ▶** button or **NUMBER** buttons.
14. Press the **OK** button.
15. Press the **▲ / ▼** button to select **Search**.
16. Press the **▶** button and then **◀ / ▶** button to commence searching on the **Search** pull-down menu. If a station is found the search will stop.
17. Press the **OK** button to store it.
18. To store another station, repeat steps 3 to 17.



19. Repeatedly press the **MENU** button to return to normal TV viewing.

Setting up TV stations

Assigning a station name

1. Repeat the 'Manual programme tuning' steps 1 to 2.
2. Press the ► button and then ▲ / ▼ button to select **Name**.
3. Press the ► button and then use the ▲ / ▼. You can use a blank, +, -, the number 0 to 9 and the alphabet A to Z. It can be saved 5 digits for name.
With the ◀ button you can select in the opposite direction.
4. Select the position by pressing the ◀ / ► button and then make your choice of the second character, and so on.
5. Press the **OK** button to store it.
6. Repeatedly press the **MENU** button to return to normal TV viewing.



Fine tuning

Normally fine tuning is only necessary if reception is poor.

1. Repeat the 'Manual programme tuning' steps 1 to 2.
2. Press the ► button and then ▲ / ▼ button to select **Fine**.
3. Press the ► button
4. Press the ◀ / ► button to fine tune for the best picture and sound on the **Fine** pull-down menu.
5. Press the **OK** button.
6. Repeatedly press the **MENU** button to return to normal TV viewing.

The finely tuned programme will be indicated by orange number during programme selection.

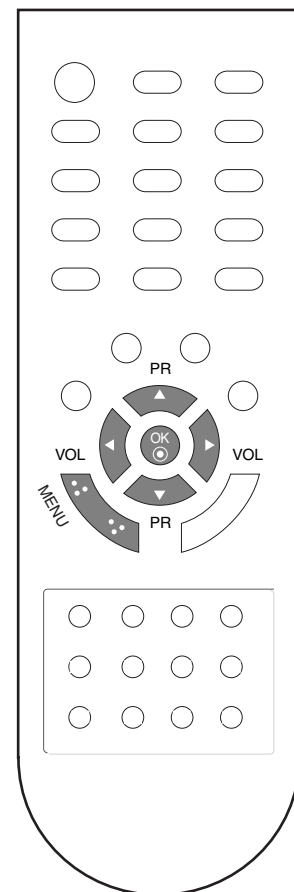

Setting up TV stations

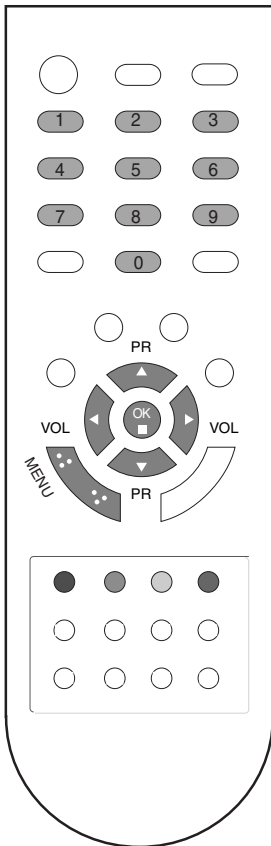

Programme edit

This function enables you to delete or skip the stored programmes. Also you can move some stations to other programme numbers or insert a blank station data into the selected programme number.

1. Press the **MENU** button and then **▲ / ▼** button to select the **Station** menu.
2. Press the **▶** button and then **▲ / ▼** button to select **Programme edit**.
3. Press the **▶** button to display the **Programme edit** menu.

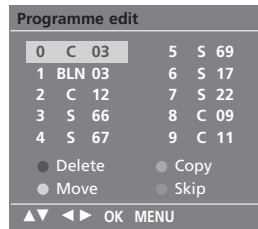

Deleting a programme

1. Select a programme to be deleted with the **▲ / ▼** or **◀ / ▶** button.
2. Press the **RED** button twice.

The selected programme is deleted, all the following programmes are shifted up one position.

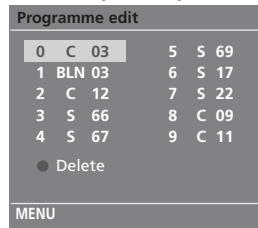

Copying a programme

1. Select a programme to be copied with the **▲ / ▼** or **◀ / ▶** button.
2. Press the **GREEN** button.

All the following programmes are shifted down one position.

Moving a programme

1. Select a programme to be moved with the **▲ / ▼** or **◀ / ▶** button.
2. Press the **YELLOW** button.
3. Move the programme to the desired programme number with the **▲ / ▼** or **◀ / ▶** button.
4. Press the **YELLOW** button again to release this function.

Skipping a programme number

1. Select a programme number to be skipped with the **▲ / ▼** or **◀ / ▶** button.
2. Press the **BLUE** button. The skipped programme turns to blue.
3. Press the **BLUE** button again to release the skipped programme. When a programme number is skipped it means that you will be unable to select it using the **▲ / ▼** button during normal TV viewing. If you want to select the skipped programme, directly enter the programme number with the **NUMBER** buttons or select it in the programme edit or table menu.

Repeatedly press the **MENU** button to return to normal TV viewing.

Setting up TV stations

Favourite programme

This function lets you select your favourite programmes directly.

1. Press the **MENU** button and then **▲ / ▼** button to select the **Station** menu.
2. Press the **▶** button and then **▲ / ▼** to select **Favourite programme**.



3. Press the **▶** button and then **◀ / ▶** button to select **On** or **Off**.
4. Press the **▲ / ▼** button to select -- -----.
5. Select a desired programme with the **◀ / ▶** button.
6. To store another programme, repeat steps 4 to 5. You can store up to 8 programmes.
7. Repeatedly press the **MENU** button to return to normal TV viewing.

Repeatedly press the **YELLOW** button to select stored favourite programmes while it is selected **On**. Repeatedly press the **YELLOW** button to select previous programmes while it is selected **Off**.

Calling the programme table

You can check the programmes stored in the memory by displaying the programme table.

Displaying programme table

Press the **LIST** button to display the **Programme table** menu. The programme table appears on the screen. One programme table contains ten programmes as below.

0	C	03	5	S	69
1	BLN	03	6	S	17
2	C	12	7	S	22
3	S	66	8	C	09
4	S	67	9	C	11

Note :

- a. You may find some blue programmes. They have been set up to be skipped by auto programming or in the programme edit mode.
- b. Some programmes with the channel shown in the programme table indicate there is no station name assigned.

Selecting a programme in the programme table

Select a programme with the **▲ / ▼** or **◀ / ▶** button. Then press the **OK** button. The set switches to the chosen programme number.

Paging through a programme table

There are 10 programme table pages in which contain 100 programmes. Pressing the **▲ / ▼** or **◀ / ▶** button repeatedly turns the pages. Press the **MENU** button to return to normal TV viewing.

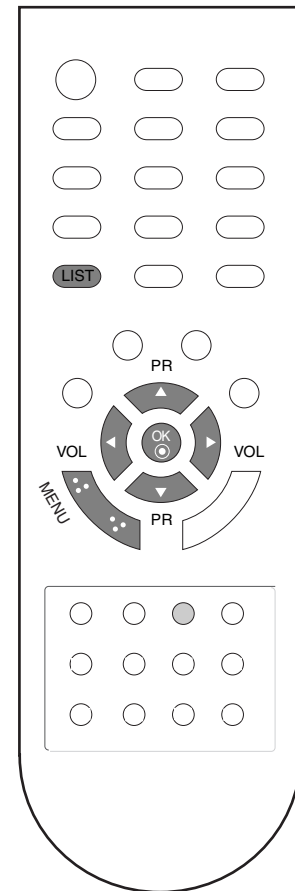

Picture adjustment

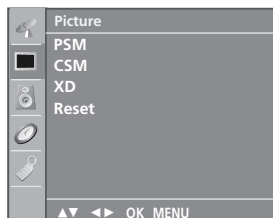

PSM (Picture Status Memory)

1. Press the **MENU** button and then ▲ / ▼ button to select the **Picture** menu.
2. Press the ▶ button and then ▲ / ▼ button to select **PSM**.
3. Press the ▶ button and then ▲ / ▼ button to select a picture setting on the **PSM** menu.
4. Press the **OK** button.

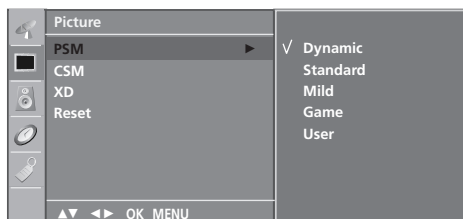

5. Repeatedly press the **MENU** button to return to normal TV viewing.

You can also recall a desired picture (**Dynamic**, **Standard**, **Mild**, **Game** or **User**) with **PSM** button on the remote control. The picture **Dynamic**, **Standard**, **Mild** and **Game** are programmed for optimum picture reproduction at the factory and cannot be changed.

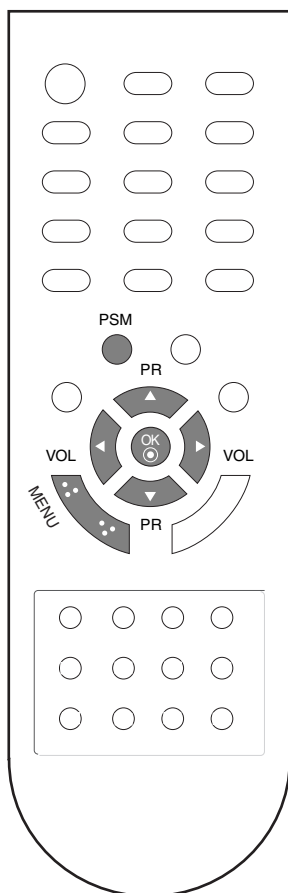

Picture adjustment

You can adjust picture contrast, brightness, colour intensity, sharpness, tint to the levels you prefer.

1. Press the **MENU** button and then ▲ / ▼ button to select the **Picture** menu.
2. Press the ▶ button and then ▲ / ▼ button to select **PSM**.
3. Press the ▶ button and then ▲ / ▼ button to select **User**.
4. Press the ▶ button and then ▲ / ▼ button to select the desired picture item.
5. Press the ▶ button and then ◀ / ▶ button to make appropriate adjustments.

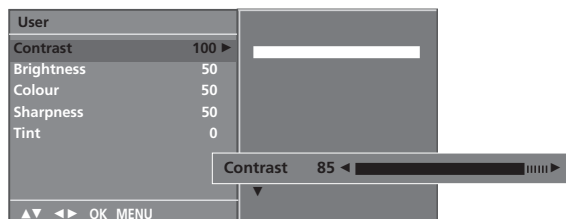

6. Repeatedly press the **MENU** button to return to normal TV viewing.

Picture adjustment

CSM (Colour Status Memory)

Selecting a factory setting colour set.

1. Press the **MENU** button and then ▲ / ▼ button to select the **Picture** menu.
2. Press the ► button and then ▲ / ▼ button to select **CSM**.

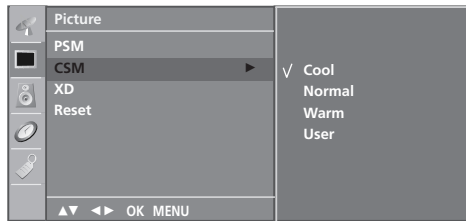

3. Press the ► button and then ▲ / ▼ button to select a color setting on the **CSM** menu: **Cool**, **Normal**, **Warm** or **User (Red, Green, Blue)**.
4. Press the **OK** button.
5. Repeatedly press the **MENU** button to return to normal TV viewing.

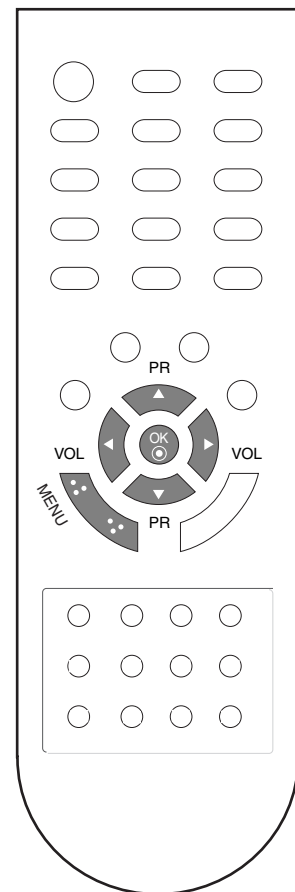
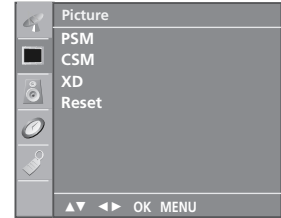

Picture adjustment

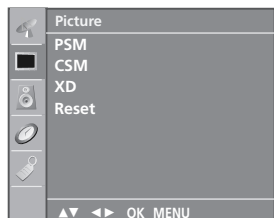

XD function

XD is LG electronic's unique picture improving technology to display a real HD source through an advanced digital signal processing algorithm.

1. Press the **MENU** button and then **▲ / ▼** button to select the **Picture** menu.
2. Press the **▶** button and then **▲ / ▼** button to select **XD**.
3. Press the **▶** button and then **▲ / ▼** button to select **Auto** or **Manual**.

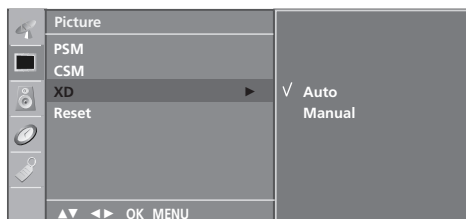

4. Press the **OK** button.
5. Repeatedly press the **MENU** button to return to normal TV viewing.

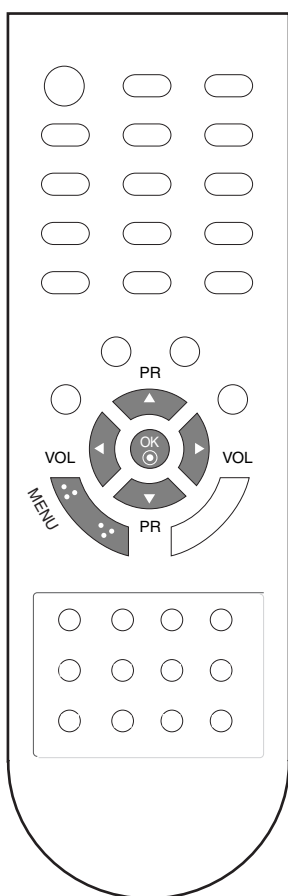

Selecting the Manual

This menu is activated after selecting the **User** of **PSM**.

1. Press the **▶** button and then **▲ / ▼** button to select **XD Contrast**, **XD Colour** or **XD NR**.
2. Press the **▶** button and then **▲ / ▼** button to select **On** or **Off**.
3. Repeatedly press the **MENU** button to return to normal TV viewing.

XD Contrast : Optimizing the contrast automatically according to the brightness of the reflection.

XD Colour : Adjusting the colors of the reflection automatically to reproduce as closely as possible to the natural colors.

XD NR : Removing the noise up to the point where it does not damage the original picture.

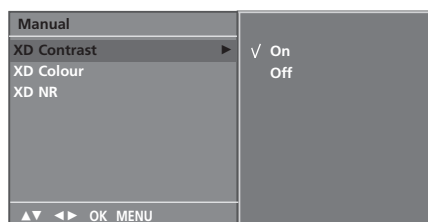

Picture adjustment

Reset

Returns to the default settings **PSM**, **CSM**, **XD**, **Cinema** at the factory.

1. Press the **MENU** button and then ▲ / ▼ button to select the **Picture** menu.
2. Press the ► button and then ▲ / ▼ button to select **Reset**.
3. Press the ► button to initialize the adjusted value.

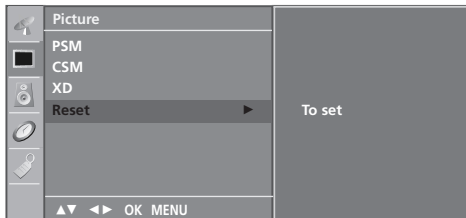

4. Repeatedly press the **MENU** button to return to normal TV viewing.

Note: This feature is not available for all models.

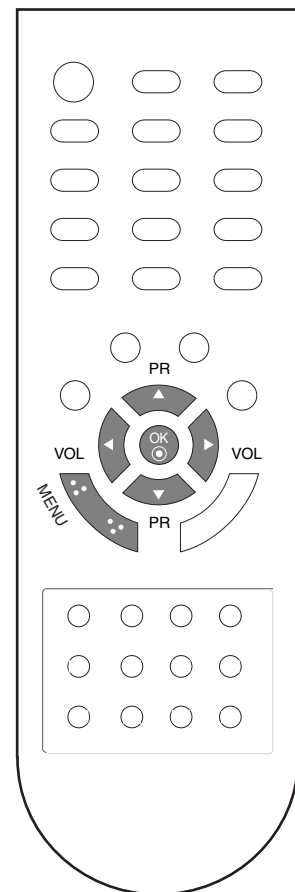
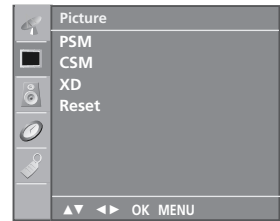

Sound adjustment

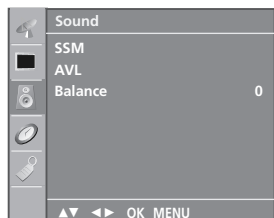

SSM (Sound Status Memory)

You can select your preferred sound setting; Flat, Music, Movie or Sports and you can also adjust the sound frequency of the equalizer.

1. Press the **MENU** button and then **▲ / ▼** button to select the **Sound** menu.

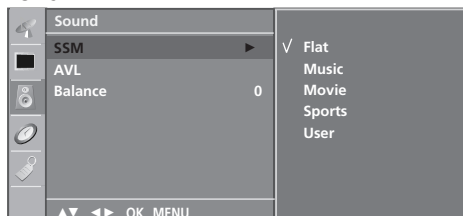

2. Press the **▶** button and then **▲ / ▼** button to select **SSM**.
3. Press the **▶** button and then **▲ / ▼** button to select a sound setting on the **SSM** menu.

Sound Frequency Adjustment

- a. Press the **OK** button in **User**.
- b. Select a sound band by pressing the **◀ / ▶** button.
- c. Make appropriate sound level with the **▲ / ▼** button.
- d. Press the **OK** button to store it for the sound **User**.

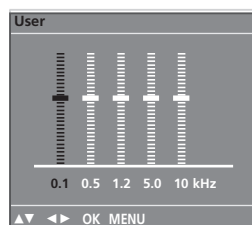

4. Repeatedly press the **MENU** button to return to normal TV viewing.

You can also recall a desired sound setting (**Flat**, **Music**, **Movie**, **Sports** or **User**) with **SSM** button on the remote control. The sound settings **Flat**, **Music**, **Movie** and **Sports** are programmed for optimum sound reproduction at the factory and cannot be changed.

Note : If you press the **SSM** button after making appropriate adjustment on the **User** sub menu, the display **User** automatically appears even though you have already set a factory preset setting; **Flat**, **Music**, **Movie** or **Sports**.

Sound adjustment

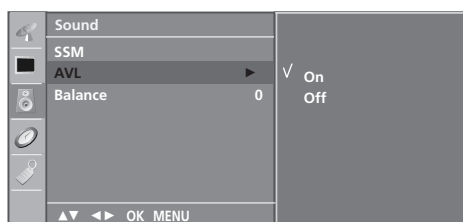

You can adjust balance, **AVL (Auto Volume Leveler)**.

AVL automatically keeps on an equal volume level even if you change programmes.

1. Press the **MENU** button and then **▲ / ▼** button to select the **Sound** menu.
2. Press the **▶** button and then **▲ / ▼** button to select the desired sound item; **AVL** or **Balance**.
3. Make desired adjustment with the **▲ / ▼**, **◀ / ▶** and then press the **OK** button.
4. Repeatedly press the **MENU** button to return to normal TV viewing.

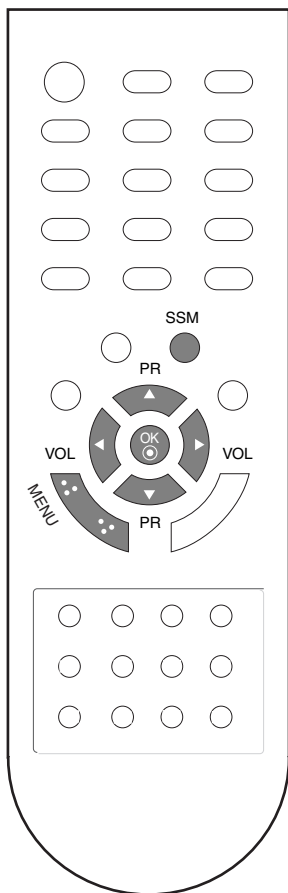

Sound adjustment

Stereo/Dual reception

When a programme is selected, the sound information for the station appears after the programme number and station name disappear.

Broadcast	On Screen Display
Mono	MONO
Stereo	STEREO
Dual	DUAL I

Mono sound selection

In stereo reception if the stereo signal is weak, you can switch to mono by pressing the **I/II** button twice. In mono reception the depth of sound is improved. To switch back to stereo, press the **I/II** button twice again.

Language selection for dual language broadcast

If a programme is received in two languages (dual language), you can switch to **DUAL I**, **DUAL II** or **DUAL I+II** by pressing the **I/II** button repeatedly.

DUAL I sends the primary broadcast language to the loudspeakers.

DUAL II sends the secondary broadcast language to the loudspeakers.

DUAL I+II sends a separate language to each loudspeaker.

NICAM reception

If your set is equipped with the receiver for NICAM reception, the high quality NICAM (Near Instantaneous Companding Audio Multiplex) digital sound can be received.

Sound output can be selected according to the type of received broadcast as follows by pressing the **I/II** button repeatedly.

1. When NICAM mono is received, you can select **NICAM MONO** or **FM MONO**.
2. When NICAM stereo is received, you can select **NICAM STEREO** or **FM MONO**. If the stereo signal is weak, switch to **FM mono**.
3. When NICAM dual is received, you can select **NICAM DUAL I**, **NICAM DUAL II** or **NICAM DUAL I+II** or **MONO**. When **FM mono** is selected the display **MONO** appears on the screen.

Sound output selection

In AV mode, you can select output sound for the left and right loudspeakers.

Repeatedly press the **I/II** button to select the sound output.

L+R : Audio signal from audio L input is sent to left loud-speaker and audio signal from audio R input is sent to right loud-speaker.

L+L : Audio signal from audio L input is sent to left and right loudspeakers.

R+R : Audio signal from audio R input is sent to left and right loudspeakers.

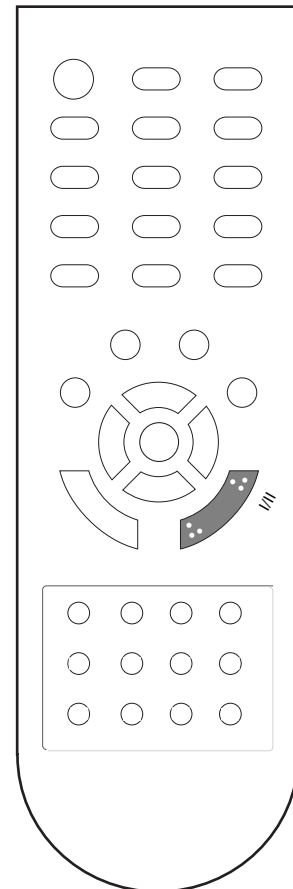

TIME Menu

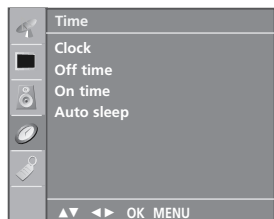

Clock

You must set the time correctly before using on/off time function.

1. Press the **MENU** button and then **▲ / ▼** button to select the **Time** menu.
2. Press the **▶** button and then **▲ / ▼** button to select **Clock**.



3. Press the **▶** button and then **▲ / ▼** button to adjust the hour.
4. Press the **▶** button and then **▲ / ▼** button to adjust the minute.
5. Press the **MENU** button to save.

On/Off time

The off timer automatically switches the set to standby at the preset time.

1. Press the **MENU** button and then **▲ / ▼** button to select the **Time** menu.
2. Press the **▶** button and then **▲ / ▼** button to select **Off time** or **On time**.
3. Press the **▶** button and then **▲ / ▼** button to select **On**.
To cancel **On/Off time** function, press the **▲ / ▼** button to select **Off**.

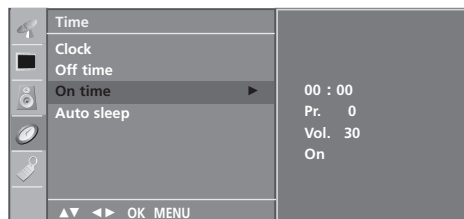

4. Press the **▶** button and then **▲ / ▼** button to adjust the hour.
5. Press the **▶** button and then **▲ / ▼** button to adjust the minute.
6. **Only On time function;** Press the **▶** button and then **▲ / ▼** button to adjust volume level and programme number.
7. Press the **MENU** button to save.

Note :

- a. In the event of power interruption (disconnection or power failure), the clock must be reset.
- b. Two hours after the set is switched on by the on time function it will automatically switch back to standby mode unless a button has been pressed.
- c. Once the on or off time is set, these functions operate daily at the preset time.
- d. Off Timer function overrides On Timer function if they are set to the same time.
- e. The set must be in standby mode for the On Timer to work.

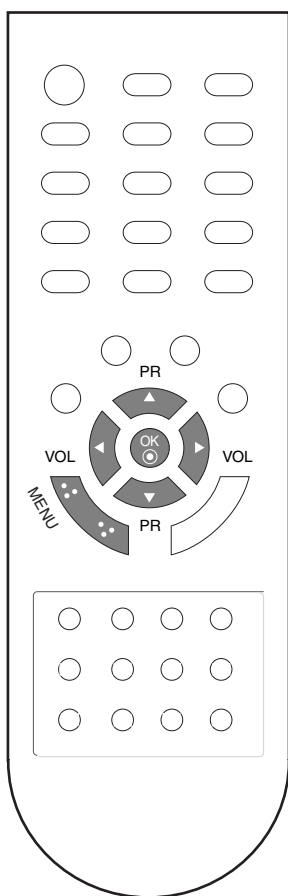

TIME Menu

Auto sleep

If you select **On** on the **Auto sleep** menu, the set will automatically switch itself to standby mode approximately ten minutes after a TV station stops broadcasting.

1. Press the **MENU** button and then **▲ / ▼** button to select the **Time** menu.
2. Press the **▶** button and then **▲ / ▼** button to select **Auto sleep**.
3. Press the **▶** button and then **▲ / ▼** button to select **On** or **Off**.



4. Press the **MENU** button to save.

Sleep timer

You don't have to remember to switch the set off before you go to sleep. The sleep timer automatically switches the set to standby after the preset time has elapsed.

Press the **SLEEP** button to select the number of minutes.

The display '**⌚ ---**' will appear on the screen, followed by **10, 20, 30, 60, 90, 120, 180** and **240**. The timer begins to count down from the number of minutes selected.

Note :

- a. To view the remaining sleep time, press the **SLEEP** button once.
- b. To cancel the sleep time, repeatedly press the **SLEEP** button until the display '**⌚ ---**' appears.
- c. When you switch the set off, the set releases the preset sleep time.

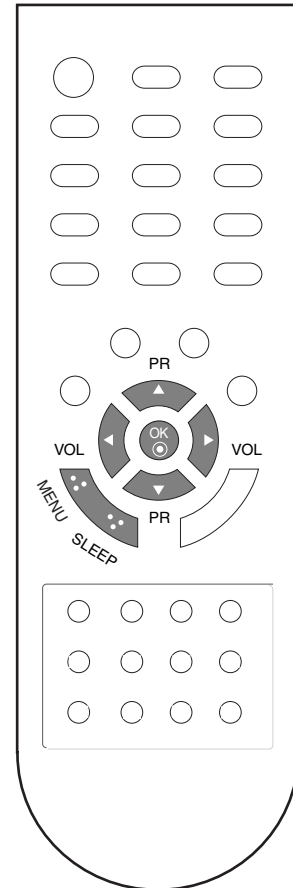
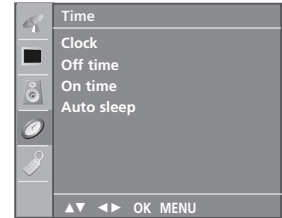

Other functions



Child lock

The TV can be set so that the remote control handset is needed to control it. This feature can be used to prevent unauthorized viewing.

1. Press the **MENU** button and then ▲ / ▼ button to select the **Special** menu.
2. Press the ► button and then ▲ / ▼ button to select **Child lock**.
3. Press the ► button and then ▲ / ▼ button to select **On** or **Off** on the **Child lock** menu.



4. Press the **MENU** button to save.
5. Repeatedly press the **MENU** button to return to normal TV viewing.

With the lock on, the display **Child lock on** appears on the screen if any button on the top panel is pressed while viewing the TV.

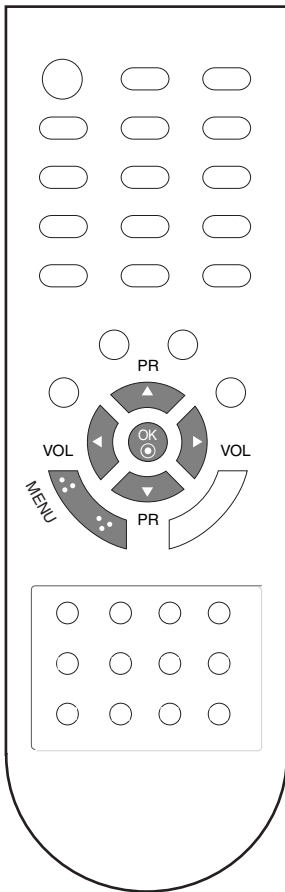

Other functions

XD Demo

Use it to see the difference between XD Demo on and XD Demo off.

1. Press the **MENU** button and then ▲ / ▼ button to select the **Special** menu.
2. Press the ► button and then ▲ / ▼ button to select **XD Demo**.
3. Press the ► button to begin XD Demo.



4. Press the **MENU** button to return to normal TV viewing.

• XD Demo

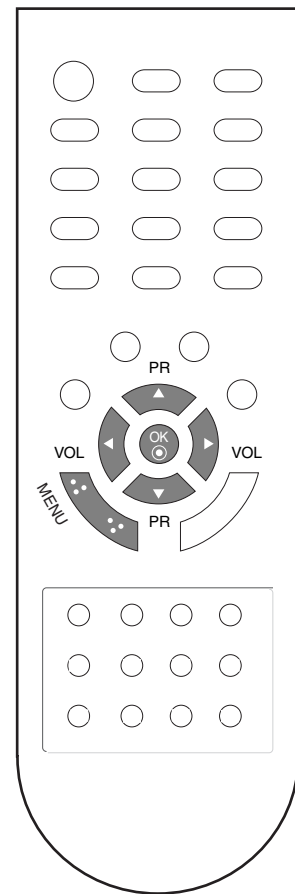

Other functions

TV, AV and PC modes

Press the **INPUT** button and then ▲ / ▼ button to select desired mode.

Inputs can be set for TV, AV mode. AV mode is used when a video cassette recorder (VCR), or other equipment is connected to the set.

Note : When a VCR is connected via the aerial socket the set is used in TV mode. See the 'Connection of external equipment' section.

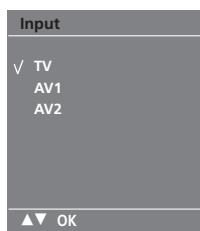
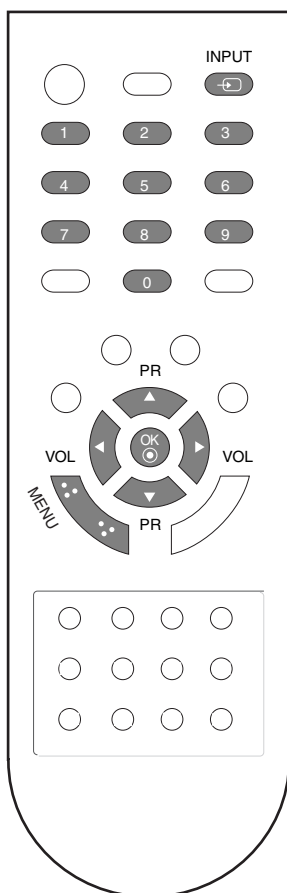

The AV modes are :

- AV 1 : VCR connected to the Euro scart socket of the set.
- AV 2 : VCR connected to the **AV IN 2** or **S-Video** of the set.

Auto AV switching

If your VCR outputs an AV switching voltage when connected to the Euro scart socket, the set will switch to **AV1** mode automatically. But if you want to keep on watching TV mode, press the ▲ / ▼ or NUMBER buttons.

Teletext

- This feature is not available in all countries.

Teletext (or TOP text) is an optional function, therefore only a set with the teletext system can receive the teletext broadcast.

Teletext is a free service broadcast by most TV stations which gives up-to-the-minute information on news, weather, television programmes, share prices and many other topics.

The teletext decoder of this TV can support the SIMPLE, TOP and FASTEXT systems. SIMPLE (standard teletext) consists of a number of pages which are selected by directly entering the corresponding page number. TOP and FASTEXT are more modern methods allowing quick and easy selection of teletext information.

Switch on/off

Press the **TEXT** button to switch to teletext. The initial page or last page appears on the screen.

Two page numbers, TV station name, date and time are displayed on the screen headline. The first page number indicates your selection, while the second shows the current page displayed. Press the **TEXT** button to switch off teletext. The previous mode reappears.

SIMPLE text

Page selection

1. Enter the desired page number as a three digit number with the **NUMBER** buttons. If during selection you press a wrong number, you must complete the three digit number and then re-enter the correct page number.
2. The **▲ / ▼** button can be used to select the preceding or following page.

Programming a colour button in LIST mode

If the TV is in SIMPLE text, TOP text or FASTEXT mode, press the **EM** button to switch to LIST mode.

Four teletext page numbers of your choice can be colour coded and easily selected by pressing the corresponding coloured button on the remote control handset.

1. Press a coloured button.
2. Using the **NUMBER** buttons, select the page you wish to programme.
3. Press the **OK** button. Then the selected page is stored as the selected page number by blinking once. From now on, you can select this page with the same coloured button.
4. The three other coloured buttons are programmed in this way.

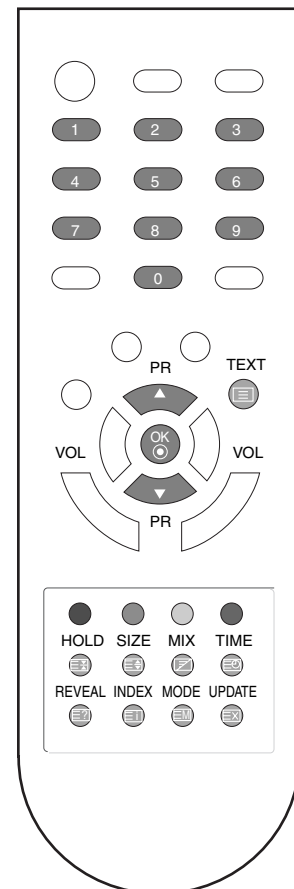

Teletext

TOP text

The user guide displays four fields-red, green, yellow and blue at the bottom of the screen. The yellow field denotes the next group and the blue field indicates the next block.

Block / group / page selection

1. With the blue button you can progress from block to block.
2. Use the yellow button to proceed to the next group with automatic overflow to the next block.
3. With the green button you can proceed to the next existing page with automatic overflow to the next group. Alternatively the ▲ button can be used.
4. The red button permits to return to previous selection. Alternatively the ▼ button can be used.

Direct page selection

Corresponding to the SIMPLE teletext mode, you can select a page by entering it as a three digit number using the NUMBER buttons in TOP mode.

FASTEXT

The teletext pages are colour coded along the bottom of the screen and are selected by pressing the corresponding coloured button.

Page selection

1. Press the  button to select the index page.
2. You can select the pages which are colour coded along the bottom line with the same coloured buttons.
3. Corresponding to the SIMPLE teletext mode, you can select a page by entering its three digit page number with the NUMBER buttons in FASTEXT mode.
4. The ▲ / ▼ button can be used to select the preceding or following page.

Special teletext functions



REVEAL

Press this button to display concealed information, such as solutions of riddles or puzzles. Press this button again to remove the information from the display.





SIZE

Selects double height text.
Press this button to enlarge the top half of the page.
Press this button again to enlarge the bottom half of the page.
Press this button again to return to the normal display.



UPDATE

Displays the TV picture on the screen while waiting for the new teletext page. The display  will appear at the top left hand corner of the screen. When the updated page is available then display  will change to the page number. Press this button to view the updated teletext page.



HOLD

Stops the automatic page change which will occur if a teletext page consists of 2 or more sub pages. The number of sub pages and the sub page displayed is, usually, shown on the screen below the time. When this button is pressed the stop symbol is displayed at the top left-hand corner of the screen and the automatic page change is inhibited. To continue press this button again.



MIX

Displays the teletext pages superimposed on the TV picture. To switch the TV picture off press this button again.



TIME

When viewing a TV programme, press this button to display the time at the top right hand corner of the screen. Press this button again to remove the display. In the teletext mode, press this button to select a sub page number. The sub page number is displayed at the top left hand corner of the screen. To hold or change the sub page, press the NUMBER buttons. Press again to exit this function.

Connection of external equipment

You can connect additional equipment, such as VCRs, camcorders etc. to your set. Examples are shown below.

Note: Here shown may be somewhat different from your set.

Aerial socket

1. Connect the RF out socket of the VCR to the aerial socket of the set.
2. Connect the aerial cable to the RF aerial in socket of the VCR.
3. Store the VCR channel on a desired programme number using the 'Manual programme tuning' section.
4. Select the programme number where the VCR channel is stored.
5. Press the **PLAY** button on the VCR.

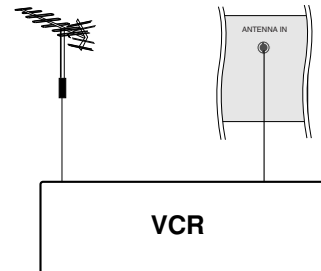

Euro scart socket (VCR)

1. Connect the Euro scart socket of the VCR to the Euro scart socket of the set.
2. Press the **PLAY** button on the VCR.
If your VCR outputs an AV switching signal via the Scart lead the set will auto switch to **AV 1** mode on start of playback, but if you want to keep on watching in TV mode, press the **▲ / ▼** or **NUMBER** buttons.

Otherwise press the **INPUT** button on the remote control handset to select **AV1**. The VCR play back picture appears on the screen.

You can also record programmes received by the TV on video tape.

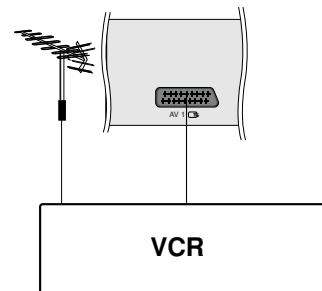

Note :

- a. Signal type RGB, i.e. the signals red, green and blue can only be selected for the Euro scart and the **AV1** can be received. These signals are transmitted, for example, by a pay TV decoder, game machine or photo CD unit, etc.
- b. Please use shielded scart cable.

Audio/Video in sockets

1. Connect the audio/video out sockets of the VCR to audio/video in sockets of the set.
2. Press the **INPUT** button to select **AV 2**.
3. Press the **PLAY** button on the VCR.
The VCR playback picture appears on the screen.

Note : If you have a mono VCR, connect the audio cable from the VCR to the **AUDIO L/MONO** socket of the set.

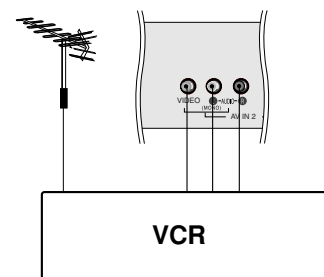

Connection of external equipment

S-Video/Audio in sockets (S-Video)

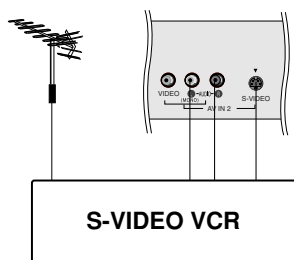

When connecting an S-VIDEO VCR to the **S-VIDEO** socket, the picture quality will be further improved.

1. Connect the S-Video socket of the VCR to the **S-VIDEO** socket of the set.
2. Connect the audio cable from the S-VIDEO VCR to the **AUDIO** sockets of the set.
3. Press the **INPUT** button to select **AV 2**.
4. Press the **PLAY** button on the VCR.
The VCR playback picture appears on the screen.

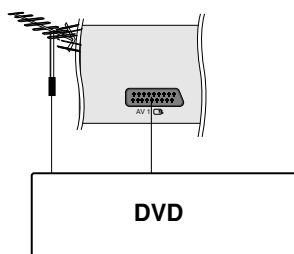

DVD input sockets

Euro scart socket

1. Connect the Euro scart socket of the DVD to the Euro scart socket of the set.
2. Press the **INPUT** button to select **AV1**.
3. Press the **PLAY** button on the DVD.
The DVD playback picture appears on the screen.

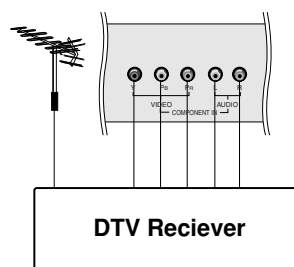
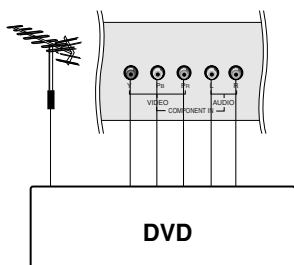

External Control Device Setup ; RS-232C

Connect the RS-232C input jack to an external control device (such as a computer or an A/V control system) and control the TV's functions externally.

Connect the serial port of the control device to the RS-232C jack on the TV back panel. RS-232C connection cables are not supplied with the TV.

RS-232C Setup

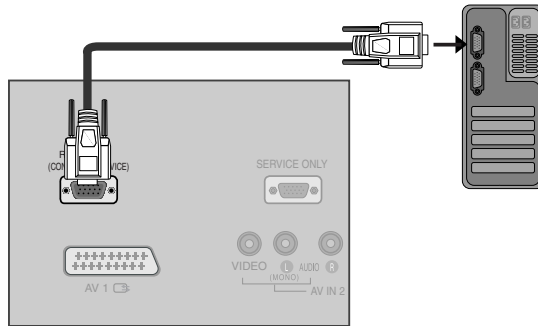

Type of Connector; D-Sub 9-Pin Male

No.	Pin Name
1	No connection
2	RX
3	TX
4	IR-Out
5	GND
6	No connection
7	Power Output (5V Standby output)
8	No connection
9	No Connection

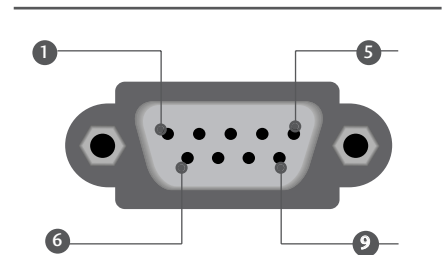

RS-232C Configurations

7-Wire Configurations (Standard RS-232C cable)

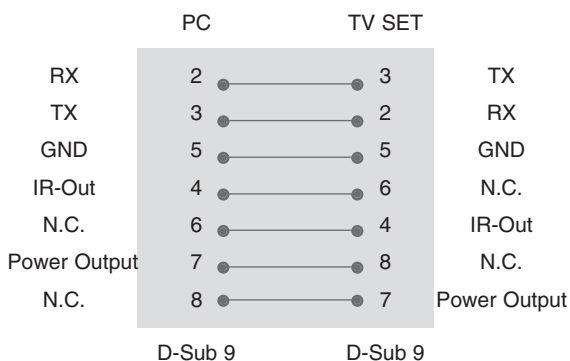

3-Wire Configurations (Non-interactive installation)

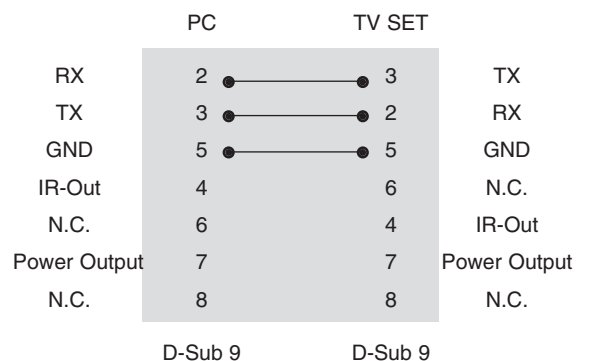

External Control Device Setup ; RS-232C

Set ID

- Use this function to specify a monitor ID number.
- Refer to 'Real Data Mapping 1'. See page 38.
- **Set ID Setup** is located in service menu. (ADJ => MENU => Set ID Setup)

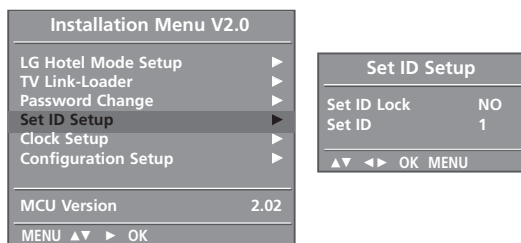

Communication Parameters

- Baud rate : 9600 bps (UART)
- Data length : 8 bits
- Parity : None
- Use a crossed (reverse) cable.
- Stop bit : 1 bit
- Communication code : ASCII code

Command Reference List

	COMMAND 1	COMMAND 2	DATA (Hexa)
01. Power	k	a	0 ~ 1
02. Aspect Ratio	k	c	*
03. Screen Mute	k	d	0 ~ 1
04. Volume Mute	k	e	0 ~ 1
05. Volume Control	k	f	0 ~ 64
06. Contrast	k	g	0 ~ 64
07. Brightness	k	h	0 ~ 64
08. Colour	k	i	0 ~ 64
09. Tint	k	j	0 ~ 64
10. Sharpness	k	k	0 ~ 64
11. OSD Select	k	l	0 ~ 1
12. Remote Control lock mode	k	m	0 ~ 1
13. PIP/DW	k	n	*
14. PIP Position	k	q	0 ~ 3
15. Balance	k	t	0 ~ 64
16. Colour Temperature	k	u	0 ~ 3
17. Red Adjustment	k	v	0 ~ 3C (or 50)
18. Green Adjustment	k	w	0 ~ 3C (or 50)
19. Blue Adjustment	k	\$	0 ~ 3C (or 50)
20. Abnormal Status	k	z	FF
21. ISM Method	j	p	0 ~ 3
22. Low Power	j	q	0 ~ 1
23. Orbiter Time Setting	j	r	1 ~ FE
24. Orbiter Pixel Setting	j	s	1 ~ 3
25. Auto Configure	j	u	1
26. Tune Command	m	a	*
27. Key	m	c	Key Code
28. Input select (Main)	x	b	*
29. Input select (PIP)x	x	y	*

Transmission / Receiving Protocol

Transmission

[Command1][Command2][][Set ID][][Data][Cr]

- * [Command 1] : First command to control the set.(j,k,mor x)
- * [Command 2] : Second command to control the set.
- * [Set ID] : You can adjust the selDtochoosedesired TV ID number in Setup menu. Adjustment range is 1~99. When selecting Set ID '0', every connected the TV is controlled. Set ID is indicated as decimal (1~99) on menu and as Hexa decimal (0x0~0x63) on transmission/receiving protocol.
- * [DATA] : To transmit command data.
Transmit 'FF' data to read status of comand.
- * [Cr] : Carriage Return
ASCII code '0x0D'
- * [] : ASCII code 'space (0x20)'

OK Acknowledgement

[Command2][][Set ID][][OK][Data][x]

- * The set transmits ACK (acknowledgement) based on this format when receiving normal data. At this time, if the data is data read mode, it indicates present status data. If the data is data write mode, it returns the data of the PC computer.

Error Acknowledgement

[Command2][][Set ID][][NG][Data][x]

- * The set transmits ACK (acknowledgement) based on this format when receiving abnormal data from non-viable functions or communication errors.
Data1: Illegal Code
Data2: Not supported function
Data3: Wait more time

External Control Device Setup ; RS-232C

01. Power (Command2:a)

To control Power On/Off of the TV.

Transmission [k][a][][Set ID][][Data][Cr]

Data 0 : Power Off Data 1 : Power On

Acknowledgement [a][][Set ID][][OK][Data][x]

To show Power On/Off.

Transmission [k][a][][Set ID][][FF][Cr]

Acknowledgement [a][][Set ID][][OK][Data][x]

* In a like manner, if other functions transmit 'FF' data based on this format, Acknowledgement data feedback presents status about each function.

* To change the Power on input the transmission more than twice.

02. Aspect Ratio (Command2:c) (Main picture size)

To adjust the screen format. (Main picture format)

You can also adjust the screen format using the ARC (Aspect Ratio Control) button on remote control or in the SCREEN menu.

Transmission [k][c][][Set ID][][Data][Cr]

Data 1: Normal screen (4:3)	Data 5: Full screen (Zoom2)
Data 2: Wide screen (16:9)	Data 6: Original
Data 3: Spectacle	Data 7: Wide screen (14:9)
Data 4: Full screen (Zoom1)	Data 8: Full (Option)

Acknowledgement [c][][Set ID][][OK][Data][x]

* Using the RGB-PC or Component input, you select either 16:9 or 4:3 screen aspect ratio.

03. Screen Mute (Command2:d)

To select screen mute on/off.

Transmission [k][d][][Set ID][][Data][Cr]

Data 0 : Screen mute off (Picture on)
Data 1 : Screen mute on (Picture off)

Acknowledgement [d][][Set ID][][OK][Data][x]

04. Volume Mute (Command2:e)

To control volume mute on/off.

You can also adjust mute using the MUTE button on remote control.

Transmission [k][e][][Set ID][][Data][Cr]

Data 0 : Volume mute off (Volume on)
Data 1 : Volume mute on (Volume off)

Acknowledgement [e][][Set ID][][OK][Data][x]

05. Volume Control (Command2:f)

To adjust volume.

You can also adjust volume with the volume buttons on remote control.

Transmission [k][f][][Set ID][][Data][Cr]

Data Min : 0 ~ Max : 64

Refer to 'Real data mapping 1'. See page 6.

Acknowledgement [f][][Set ID][][OK][Data][x]

06. Contrast (Command2:g)

To adjust screen contrast.

You can also adjust contrast in the PICTURE menu.

Transmission [k][g][][Set ID][][Data][Cr]

Data Min : 0 ~ Max : 64

Refer to 'Real data mapping 1'. See page 6.

Acknowledgement [g][][Set ID][][OK][Data][x]

07. Brightness (Command2:h)

To adjust screen brightness.

You can also adjust brightness in the PICTURE menu.

Transmission [k][h][][Set ID][][Data][Cr]

Data Min : 0 ~ Max : 64

Refer to 'Real data mapping 1'. See page 6.

Acknowledgement [h][][Set ID][][OK][Data][x]

08. Colour (Command2:i)

To adjust the screen colour.

You can also adjust colour in the PICTURE menu.

Transmission [k][i][][Set ID][][Data][Cr]

Data Min : 0 ~ Max : 64

Refer to 'Real data mapping 1'. See page 6.

Acknowledgement [i][][Set ID][][OK][Data][x]

09. Tint (Command2:j)

To adjust the screen tint.

You can also adjust tint in the PICTURE menu.

Transmission [k][j][][Set ID][][Data][Cr]

Data Red : 0 ~ Green : 64

Refer to 'Real data mapping 1'. See page 6.

Acknowledgement [j][][Set ID][][OK][Data][x]

External Control Device Setup ; RS-232C

10. Sharpness (Command2:k)

To adjust the screen sharpness.

You can also adjust sharpness in the PICTURE menu.

Transmission [k][k][][Set ID][][Data][Cr]

Data Min: 0 ~ Max: 64

Refer to 'Real data mapping 1'. See page 6.

Acknowledgement [k][][Set ID][][OK][Data][x]

11. OSD Select (Command2:l)

To select OSD (On Screen Display) on/off when controlling remotely.

Transmission [k][l][][Set ID][][Data][Cr]

Data 0: OSD off

Data 1: OSD on

Acknowledgement [l][][Set ID][][OK][Data][x]

12. Remote Control Lock Mode (Command2:m)

To lock the remote control and the front panel controls on the set.

Transmission [k][m][][Set ID][][Data][Cr]

Data 0: Lock off

Data 1: Lock on

Acknowledgement [m][][Set ID][][OK][Data][x]

If you're not using the remote control and front panel controls on the TV, use this mode. When main power is on/off, remote control lock is released.

13. PIP / DW (Command2:n)

To control the PIP (Picture In picture)/DW.

You can also control the PIP/DW using the PIP button on the remote control or in the PIP/DW menu.

Transmission [k][n][][Set ID][][Data][Cr]

Data 0: PIP/DW off

Data 1: PIP

Data2: DW1 (option)

Data3: DW2

Data5: POP (option)

Acknowledgement [n][][Set ID][][OK][Data][x]

14. PIP Position (Command2:q)

To select sub picture position for PIP.

You can also adjust the sub picture position using POSITION button on the remote control or in the PIP/DW menu.

Transmission [k][q][][Set ID][][Data][Cr]

Data 0: Right down on screen

Data 1: Left down on screen

Data 2: Left up on screen

Data 3: Right up on screen

Acknowledgement [q][][Set ID][][OK][Data][x]

15. Balance (Command2:t)

To adjust balance.

You can also adjust balance in the SOUND menu.

Transmission [k][t][][Set ID][][Data][Cr]

Data Min: 0 ~ Max: 64

Refer to 'Real data mapping 1'. See page 6.

Acknowledgement [t][][Set ID][][OK][Data][x]

16. Color Temperature (Command2:u)

To adjust color temperature.

You can also adjust CSM in the PICTURE menu.

Transmission [k][u][][Set ID][][Data][Cr]

Data 0: Cool 1: Normal 2: Warm 3: User

Acknowledgement [u][][Set ID][][OK][Data][x]

17. Red Adjustment (Command2:v)

To adjust red in colour temperature.

Transmission [k][v][][Set ID][][Data][Cr]

Data Min: 0 ~ Max: 3C (or 50)

Refer to 'Real data mapping 2'. See page 6.

Acknowledgement [v][][Set ID][][OK][Data][x]

18. Green Adjustment (Command2:w)

To adjust red in colour temperature.

Transmission [k][w][][Set ID][][Data][Cr]

Data Min: 0 ~ Max: 3C (or 50)

Refer to 'Real data mapping 2'. See page 6.

Acknowledgement [w][][Set ID][][OK][Data][x]

19. Blue Adjustment (Command2:\$)

To adjust red in colour temperature.

Transmission [k][\$][][Set ID][][Data][Cr]

Data Min: 0 ~ Max: 3C (or 50)

Refer to 'Real data mapping 2'. See page 6.

Acknowledgement [\$][][Set ID][][OK][Data][x]

External Control Device Setup ; RS-232C

20. Abnormal State (Command2:z)

To recognize an abnormal state.

This feature is not available for all models.

Transmission [k][z][][Set ID][][FF][][Cr]

Data FF: Read

Acknowledgement [z][][Set ID][][OK][Data][x]

Data 0: Normal (Power on and signal exist)

Data 1: No signal (Power on)

Data 2: Turn the TV off by remote control

Data 3: Turn the TV off by sleep time function

Data 4: Turn the TV off by RS-232C function

Data 5: 5V down

Data 6: AC down

Data 7: Turn the TV off by Fan Alarm function (option)

Data 8: Turn the TV off by Off time function

Data 9: Turn the TV off by Auto sleep function

* This function is "read only".

21. ISM Method (Command1:j, Command2:p)

To control the ISM method. You can also adjust ISM Method in SPECIAL menu.

This feature is not available for all models.

Transmission [j][p][][Set ID][][Data][Cr]

Data 0: Normal Mode Data 1: White Wash

Data 2: Orbiter Data 3: Inversion

Acknowledgement [p][][Set ID][][OK][Data][x]

22. Low Power (Command1:j, Command2:q)

To reduce the power consumption of the monitor. You can also adjust Low Power in SPECIAL menu.

This feature is not available for all models.

Transmission [j][q][][Set ID][][Data][][Cr]

Data 0: Off Data 1: On

Acknowledgement [q][][Set ID][][OK][Data][x]

23. Orbiter Time Setting (Command1:j, Command2:r)

To adjust orbiter operation time term.

This feature is not available for all models.

Transmission [j][r][][Set ID][][Data][][Cr]

Data Min: 1 ~ Max: FE

Refer to 'Real data mapping 1'.

Acknowledgement [r][][Set ID][][OK][Data][x]

24. Orbiter Pixel Setting (Command1:j, Command2:s)

To adjust pixel number in orbiter function.

This feature is not available for all models.

Transmission [j][s][][Set ID][][Data][Cr]

Data Min: 1 ~ Max: 3

Refer to 'Real data mapping 1'.

Acknowledgement [s][][Set ID][][OK][Data][x]

25. Auto Configure (Command1:j, Command2:u)

To adjust picture position and minimize image shaking automatically. It works only in RGB (PC) mode.

Transmission [j][u][][Set ID][][Data][Cr]

Data 1: To set

Acknowledgement [u][][Set ID][][OK][Data][x]

26. Programme selection (Command1:m, Command2:a)

To select a programme for the main picture.

Transmission [m][a][][Set ID][][Data0][][Data1][][Data2][Cr]

Data 0: Min: 0 ~ Max: 63 (0 ~ C7, 200 Pr is on)

Refer to 'Real data mapping 1'.

Data 1: Don't care

Data 2: 0 : Main

1 : Sub

Acknowledgement [a][][Set ID][][OK][Data0][x]

* Real data mapping 1

0 : Step 0
 ⋮
 A : Step 10 (Set ID 10)
 ⋮
 F : Step 15 (Set ID 15)
 10 : Step 16 (Set ID 16)
 ⋮
 64 : Step 100
 ⋮
 6E : Step 110
 ⋮
 73 : Step 115
 74 : Step 116
 ⋮
 C7 : Step 199
 ⋮
 FE : Step 254
 FF : Step 255

* Real data mapping 2

0 : -40
 1 : -39
 2 : -38
 ⋮
 28 : 0
 ⋮
 4E : +38
 4F : +39
 50 : +40

External Control Device Setup ; RS-232C

27. Key (Command1:m, Command2:c)

To send IR remote key code.

Transmission [m][c][][Set ID][][Data][Cr]

Data: Key code - Refer to page 9

Acknowledgement [c][][Set ID][][OK][Data][x]

28. Input select (Command1:x, Command2:b)

(Main Picture Input)

To select input source for TV

Transmission [x][b][][Set ID][][Data][Cr]

Data: Structure

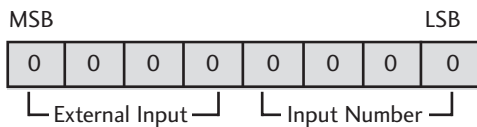

External Input				Data
0	0	0	1	Analog
0	0	1	0	AV
0	0	1	1	S-Video (option)
0	1	0	0	Component
0	1	0	1	RGB-DTV
0	1	1	0	RGB-PC
1	0	0	1	HDMI (option)

Input Number				Data
0	0	0	0	Input1
0	0	0	1	Input2
0	0	1	0	Input3
0	0	1	1	Input4
0	1	0	0	Input5
0	1	0	1	Input6

Acknowledgement [b][][Set ID][][OK][Data][x]

29. Input select (Command1:x, Command2:y)

To adjust input source for sub picture in PIP mode

Transmission [x][y][][Set ID][][Data][Cr]

Data: Structure

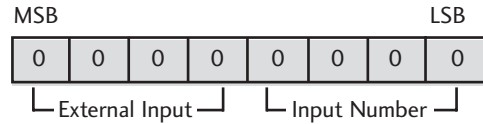

External Input				Data
0	0	0	1	Analog
0	0	1	0	AV
0	0	1	1	S-Video (option)

Input Number				Data
0	0	0	0	Input1
0	0	0	1	Input2
0	0	1	0	Input3
0	0	1	1	Input4
0	1	0	0	Input5
0	1	0	1	Input6

Acknowledgement [y][][Set ID][][OK][Data][x]

IR CODES

Remote Control IR Codes

Output waveform

Single pulse, modulated with 37.917KHz signal at 455KHz

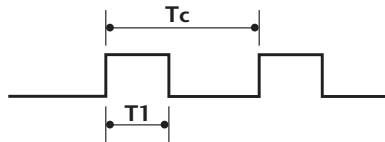

Carrier frequency
 $FCAR = 1/TC = fOSC/12$
 Duty ratio = $T1/TC = 1/3$

Configuration of frame

1st frame



Repeat frame



Lead code



Repeat code

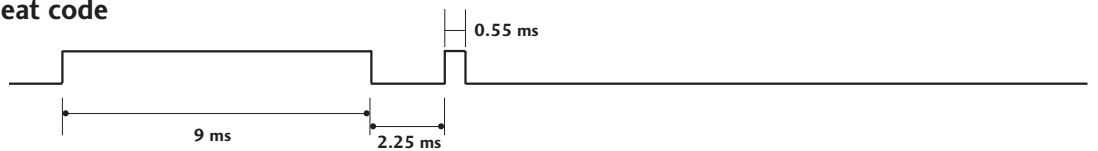

Bit description

Bit "0"

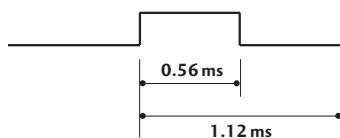

Bit "1"

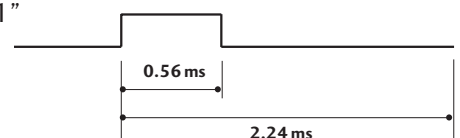

Frame interval: Tf

The waveform is transmitted as long as a key is depressed.

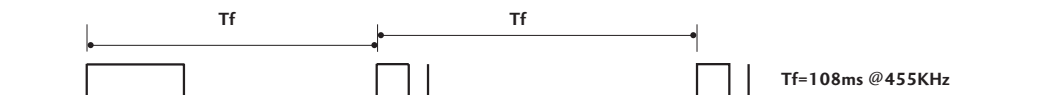

REMOTE CONTROL IR CODES

Code (Hexa)	Function	Note	Code (Hexa)	Function	Note
0F	TV	R/C Button	71	GREEN	R/C Button
0B	INPUT	R/C Button	63	YELLOW	R/C Button
08	POWER	R/C Button (Power On/Off)	61	BLUE	R/C Button
C4	POWER ON	Discrete IR Code (Only Power On)	02	VOL +	R/C Button
C5	POWER OFF	Discrete IR Code (Only Power OFF)	03	VOL -	R/C Button
0E	SLEEP	R/C Button	00	PR +	R/C Button
20	TEXT	R/C Button	01	PR -	R/C Button
0A	I/II	R/C Button	09	MUTE	R/C Button
43	MENU	R/C Button	53	LIST	R/C Button
07	◀	R/C Button	10 ~ 19	Number Key 0 ~ 9	R/C Button
06	▶	R/C Button	1A	Q.VIEW	R/C Button
40	▲	R/C Button	62	POSITION,	R/C Button
41	▼	R/C Button	70	INDEX	R/C Button
44	OK	R/C Button	26	TIME	R/C Button
72	RED	R/C Button	2A	REVEAL	R/C Button

Troubleshooting Checklist

The operation does not work normally.

The remote control doesn't work	<ul style="list-style-type: none"> • Check to see if there is any object between the product and the remote control causing obstruction. • Are batteries installed with correct polarity (+ to +, - to -)? • Correct remote operating mode set: TV, VCR etc.? • Install new batteries.
Power is suddenly turned off	<ul style="list-style-type: none"> • Is the sleep timer set? • Check the power control settings. Power interrupted • No broadcast on station tuned with Auto off activated.

The video function does not work.

No picture & No sound	<ul style="list-style-type: none"> • Check whether the product is turned on. • Try another channel. The problem may be with the broadcast. • Is the power cord inserted into wall power outlet? • Check your antenna direction and/or location. • Test the wall power outlet, plug another product's power cord into the outlet where the product's power cord was plugged in.
Picture appears slowly after switching on	<ul style="list-style-type: none"> • This is normal, the image is muted during the product startup process. Please contact your service center, if the picture has not appeared after five minutes.
No or poor color or poor picture	<ul style="list-style-type: none"> • Adjust Color in menu option. • Keep a sufficient distance between the product and the VCR. • Try another channel. The problem may be with the broadcast. • Are the video cables installed properly? • Activate any function to restore the brightness of the picture.
Horizontal/vertical bars or picture shaking	<ul style="list-style-type: none"> • Check for local interference such as an electrical appliance or power tool.
Poor reception on some channels	<ul style="list-style-type: none"> • Station or cable product experiencing problems, tune to another station. • Station signal is weak, reorient antenna to receive weaker station. • Check for sources of possible interference.
Lines or streaks in pictures	<ul style="list-style-type: none"> • Check antenna (Change the direction of the antenna).

Troubleshooting Checklist

The audio function does not work.	
Picture OK & No sound	<ul style="list-style-type: none"> • Press the VOL (or Volume) button. • Sound muted? Press MUTE button. • Try another channel. The problem may be with the broadcast. • Are the audio cables installed properly?
No output from one of the speakers	<ul style="list-style-type: none"> • Adjust Balance in menu option.
Unusual sound from inside the product	<ul style="list-style-type: none"> • A change in ambient humidity or temperature may result in an unusual noise when the product is turned on or off and does not indicate a fault with the product.

There is a problem in PC mode. (Only PC mode applied)	
The signal is out of range.	<ul style="list-style-type: none"> • Adjust resolution, horizontal frequency, or vertical frequency. • Check the input source.
Vertical bar or stripe on back- ground & Horizontal Noise & Incorrect position	<ul style="list-style-type: none"> • Work the Auto configure or adjust clock, phase, or H/V position.
Screen color is unstable or single color	<ul style="list-style-type: none"> • Check the signal cable. • Reinstall the PC video card.

Product Specifications

Power Requirement/ Power Consumption	20LS1R* : AC100-240V~ 50/60Hz 1.0A / 60W
Dimensions (Width x Depth x Height)	20LS1R* : 573.2mm x 189.7mm x 435.5mm 22.6inches x 7.5inches x 17.1inches
Weight (Net)	20LS1R* : 6.9kg (15.3lbs)
Television System Programme Coverage	PAL/SECAM B/G/D/K, PAL I/II, SECAM L/L' VHF: E2 ~ E12, UHF: E21 ~ E69, CATV: S1 ~ S20, HYPER: S21 ~ S47
External Antenna Impedance	75 Ω

* The specifications shown above may be changed without prior notice for quality improvement.





Installation menu

Installation Guide

**MODEL: 20HIZ20
20LS1R***



Contents

Location and function of controls	3-4
Installation Menu	
Introduction	5
LG Hotel Mode setup	6-10
TVLink-Loader	11
Password Change	12
Set ID Setup	12
Clock Setup	13
Configuration setup	14
External Speaker Interface	14

Location and function of controls

Front

Top panel

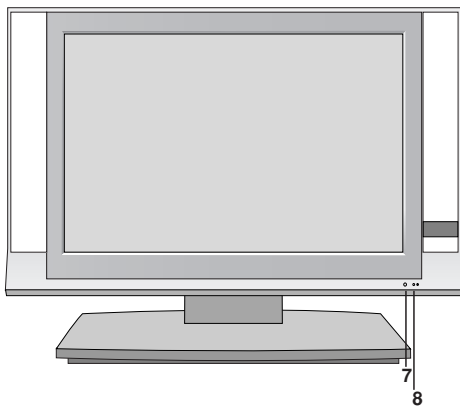
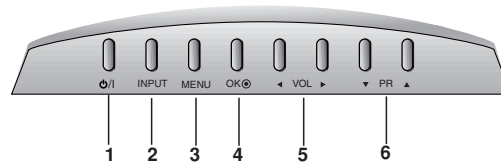

1. **ON/OFF (⏻ / I)**
switches the set on from standby or off to standby.
2. **INPUT**
selects the remote operating mode.
switches the set on from standby.
3. **MENU**
selects a menu.
4. **OK**
accepts your selection or displays the current mode.
5. **◀ / ▶ (Volume Down/Up)**
adjusts the volume.
adjusts menu settings.
6. **▼ / ▲ (Programme Down/Up)**
selects a programme or a menu item.
switches the set on from standby.
7. **REMOTE CONTROL SENSOR**
8. **POWER/STANDBY INDICATOR**
illuminates red in standby mode.
illuminates green when the set is switched on.

Location and function of controls

Rear

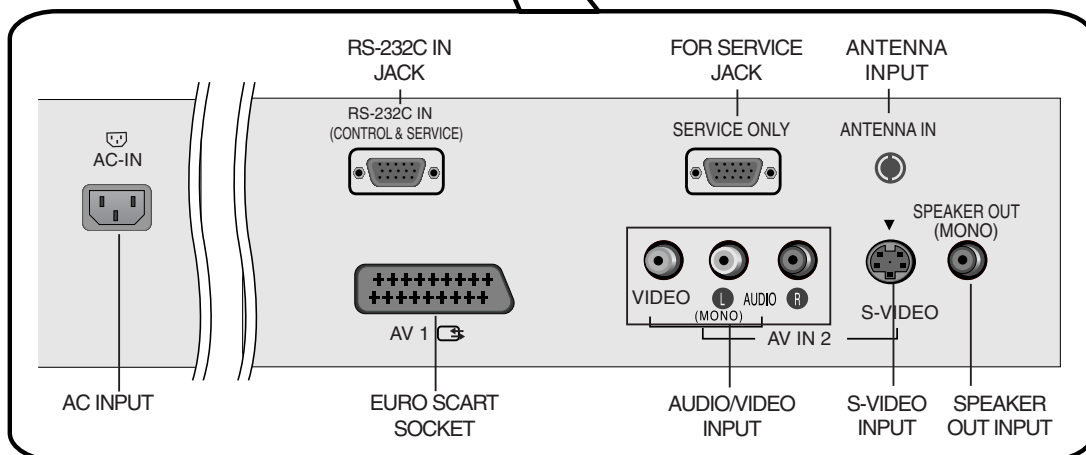
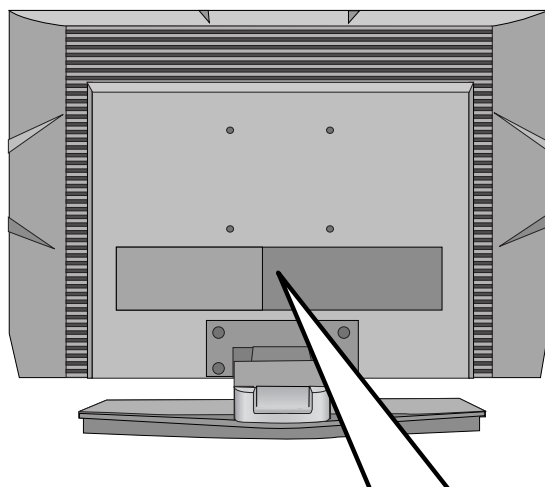

Installation Menu

Introduction

The abundant functions for Hotel TV linked with software installation can be projected on OSD as 'Installation Menu'.

The wide range of hotel features can be performed simply on additional window to enhance the LG hotel TV's easy installation and convenient operation for Hotelier and System Integrators.



- 1 Press the **MENU** button for more than 5 second using the user remote control, programme information will appear at top right on the screen.
- 2 Enter a four digit password.
 - The TV is set with the initial password "1-1-0-5" and then, **OK** button.
- 3 Use the **▲ / ▼** button to select the desired menu.

Installation Menu

LG Hotel Mode setup

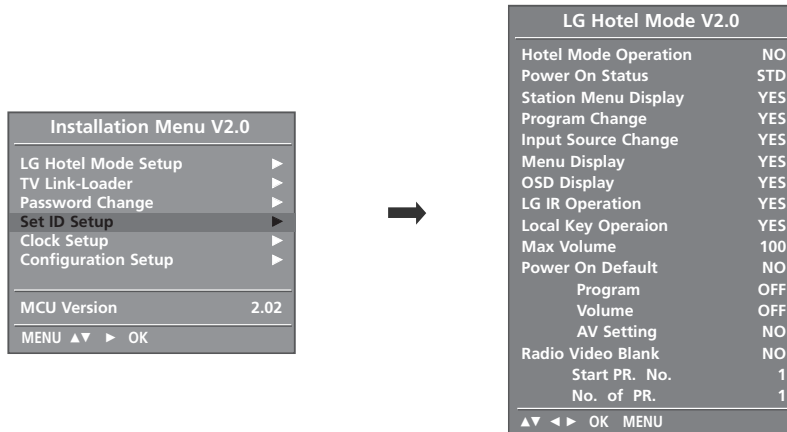

- 1 Use the ▲ / ▼ button to select the LG Hotel Mode setup.
- 2 Use the ▶ button and then ▲ / ▼ button to select Hotel Mode Operation.
*When 'Hotel Mode Operation' is set to Yes(Work), all functions of Hotel Mode apply.

(1) Hotel Mode Operation

- Decide to work all functions of 'Hotel Mode Operation' or not by setting 'Hotel Mode Operation' as Yes(Work) or No(Do Not Work)
- When 'Hotel Mode Operation' is set to Yes(Work), all functions of Hotel Mode apply.
- When 'Hotel Mode Operation' is set to No(Do Not Work), all functions of Hotel Mode Do Not apply.

(2) Power On Status

- Decide to select working status of TVSet when turn on main power.
- You can set with PWR, STD, LST.
- PWR always make set status On when turn on main power .
- STD make Stand-by status when turn on main power.
- LST make TVSet work like previous power status. As same concept as Power Backup mode; If main power were turned off in Power On status, TVSet would work in On status. If main power were turned off in Stand-by status, TVSet would work in Stand-by status.

Installation Menu

LG Hotel Mode setup

(3) Station Menu Display

- Decide to enter 'Station Menu Display' or not in the 'Main Menu' by setting 'Station Menu Display' as Yes(Enter Possible) or No(Enter Impossible) on the "LG Hotel Mode setup" OSD.

(4) Program Change

- Decide to change channel or not by setting 'Program Change' as Yes(Change Possible) or No(Change Impossible) when present source is TV.
- When 'Program Change' is set to No(Change Impossible), Program Key, Numeral Key, List Key, Q.View Key doesn't work and entering 'Channel Menu' in the Main Menu OSD is impossible.
- When 'Program Change' is set to Yes(Change Possible), Program Key, Numeral Key, List Key, Q.View Key does work and entering 'Channel Menu' in the Main Menu OSD is possible.
- When 'Program Change' is set to No(Change Impossible), 'Program' item in 'On Time' menu will be fixed.
- When 'Program Change' is set to No(Change Impossible), entering 'Station Menu' in the 'Main Menu' OSD is impossible regardless of 'Station Menu Display' item.

(5) Input Source Change

- Decide to change input source or not by setting 'Input Source Change' as Yes(Change possible) or No(Change impossible).
- When 'Input Source Change' is set to No(Change impossible), TV key and INPUT key doesn't work.
- When 'Input Source Change' is set to No(Change impossible), user's input (pressing Program key, numeral key, List key, Q.View key in all Input source except TV source) doesn't work and when entering 'Station Menu' item in the 'Main Menu OSD' except TV mode doesn't accepted.
Because entering 'Station Menu' item makes present mode as TV mode even though present mode is not TV mode. For the function that turns to TV mode doesn't work.
- When 'Input Source Change' is set to Yes(Change possible), then changing input source is available.
- When 'Input Source Change' is set to No(Change Impossible), TV set always turns on fixed input source and volume information regardless of already set Program information.
- When 'Input Source Change' is set to No(Change Impossible), entering 'Station Menu' except TV mode doesn't possible regardless of 'Program Change' or 'Station Menu Display' item.

(6) Menu Display

- Function to decide whether work with menu of local key or not.
- Set YES(Work) or NO(Do Not Work).
- Although select NO(Do Not Work), the action that press a Menu button for 5 seconds to enter Installation Menu is available.
- When select Yes(Work), Menu works.

(7) OSD Display

- Decide to display OSD or not by setting 'OSD Display' as Yes(Mark) or No(No Mark).
- When 'OSD Display' is set to No(No Mark), all OSD is not displayed except installaion menu.

Installation Menu

(8) LG IR Operation

- Decide whether work the LG remote control or not.
- Set to Yes(Work) or No(Do Not Work).
- When 'LG IR Operation' is set to NO(Not Work), all keys don't work.
- Although set to No, it can work in Service mode.
- Although set to No, Menu key action to enter the 'Installation Menu' and key action to enter Password are available.
- When 'LG IR Operation' is set to Yes(Work), all keys are available.

(9) Local Key Operation

- Decide to operate 'Local Key' or not by setting "Local Key Operation" as Yes(Work) or No(Do Not Work).
- When 'Local Key Operation' is set to No(Do Not Work), all Local Key doesn't work except volume up/down key and power key.
- When 'Local Key Operation' is set to No(Do Not Work), Local Key working in service mode is still available.
- When 'Local Key Operation' is set to Yes(Work), all Local Key working is available.
- When set both 'Local Key' and 'Remocon Operation' as No(Do Not Work), Power key of Remocon work as exceptional case.

(10) Max Volume

- Decide 'Max Volume' between changing range 0~100.
- When 'Max Volume' is set, user can change up to set volume value.
- When 'Max Volume' is set, volume just goes up to the 'Max Volume' value in 'On Time Menu'.

(11) Power On Default

- Set the channel to display and Volume Level, etc. when turn on power in AC Power On or Stand-by status.
- Set to Yes(Work) or No(Do Not Work).
- When 'Power On Default' is set to No, it is not applied to the subordinate Program, Volume, A/V Setting menu.
- When Power On Default is set to Yes, it can set by entering the subordinate menu.

(11-1) Program

- Decide to turn on TV as set Program or last memorized Program or not by setting 'Program' as On(Work) or Off(Do Not Work).
- If Program set to OFF,TV would be turned on the last input source when the TV turns off.And if the last input is RF,then TV would be turned on the last program No.
- The next value for the last program is OFF.And next it will be changed to 0.

Installation Menu

LG Hotel Mode setup

- If both 'Program' and 'On Time' is set, but just the value is different, then 'Program' value has priority.

(11-2) Volume

- Set OFF(Do Not Work)or the volume level to adjust designated volume level or last memorized volume level when the TV turns on.
- The next value for the max volume is OFF.And next it will be changed to 0.
- If both 'Volume'data and 'On Time'is set,but just the value is different,then 'Volume'has priority.

(11-3) A/V Setting

- Set to Yes(Work) or No(Do Not Work).
- If 'A/V Setting' is changed from No to Yes, parameters that are set before entering Installation Menu are applied whenever turn on power.
- Following Parameters are applied to basic.
 - Picture section - PSM mode, Picture Data (Contrast, Brightness, Color, Sharpness, Tint)
 - Sound section - SSM mode, Sound Data (Balance, Equalizer Data) and AVL and Language, Teletext language, ARC Data.

Except these, other Parameters are applied differently according to the TVSet.

(12) Radio Video Blank

- Set to Yes(Work) or No(Do Not Work).
- Program that is set to 'Radio Program' and only has Sound should decide whether to set 'Video Blank' or not.
- When 'Radio Video Blank' is set to Yes(Work), 'Video Blank' works only in case of Radio Program.
- Although set to Yes(Work), if there are Video signal, 'Video Blank' wouldn't work. In consideration of case that display background screen and broadcast only with Radio, 'Video Blank' works only when there is no Video signal.
- When set to No(Do Not Work), 'Video Blank' do not work although it is the Radio Program.

(12-1) Start PR. No.

- Item to set starting program of Radio Program.
- Available programs to set are 0~99(Chinese type: 0~199).

(12-2) No. of PR.

- Specify the number of program to set to Radio Program.
- The max value for the No. of PR is 10.
- Can not set more than maximum available program number. In other words if Start PR. are set to 95, number of program can not set more than 5.
- Radio Program should be in sequence with starting program.

Installation Menu

Initial Configuration and Configuration Detail

Item	Active	De-active	Initial
Hotel Mode Operation	Yes	No	No
Power On Status	-	-	STD
Station Menu	Yes	No	Yes
Program Change	Yes	No	Yes
Input Source Change	Yes	No	Yes
Menu Display	Yes	No	Yes
OSD Display	Yes	No	Yes
LG IR Operation	Yes	No	Yes
Local Key Operation	Yes	No	Yes
Max Volume	0~100		100
Power On Default	Yes	No	No
Program	0 ~ (Max PR. - 1)	Off	Off
Volume	0~100	Off	Off
A/V Setting	Yes	No	No
Radio Video Blank	Yes	No	No
Start PR. No.	0~99		1
No. of PR.	1~10		1

Installation Menu

TVLink-Loader

You can adjust TVLink-Loader menu by only TVLink Loader which is to be purchased additionally.

- TV sets for each single hotel rooms, providing 'TVLink-Loader' does maximise installers convenience. By copying all programming settings, picture setting, sound setting and installation menu setting, from a set as default and conveying into additional sets, which ensures uniformity between sets and significantly reduces unnecessary installation time via RS232.

In addition to this, TVLink-Loader enables to load program for menu installation with wireless basis.

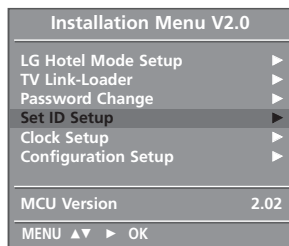

- 1 Press the **MODE** button until the display of TVLink Loader screen changes from "Ready" to "Mode in".
 - Be careful TVLink Loader doesn't move and point the TVLink Loader towards the below center on the set during this time.
- 2 Use the **UP/ DOWN** button to select the TVLink Loader .
- 3 Press the **MODE** button in order to change from \uparrow key to \leftrightarrow key and then press the **UP** button.

Ready to Download...

- 4 Press the **SEND** or **RECIEVE** button.
 - **RECIEVE**: RS232 is the main connection for receiving data.
 - **SEND**: For transmitting reserved data can be done by wireless IR Signal or RS232.
 1. Press SEND button to select "IR Send"(to send data through IR)or "RS Send"(to send data through RS232)for the download mode.
 2. Press ENTER button to start transmitting.
- 5 The procedure of Loading will be projected on OSD.

Downloading... 40

- 6 Disappearing OSD implies Completion of data recieving or TV turns off automatically after completion of data sending.

Installation Menu

Password Change

-To ensure more security, Password can be changed by installers' own design.

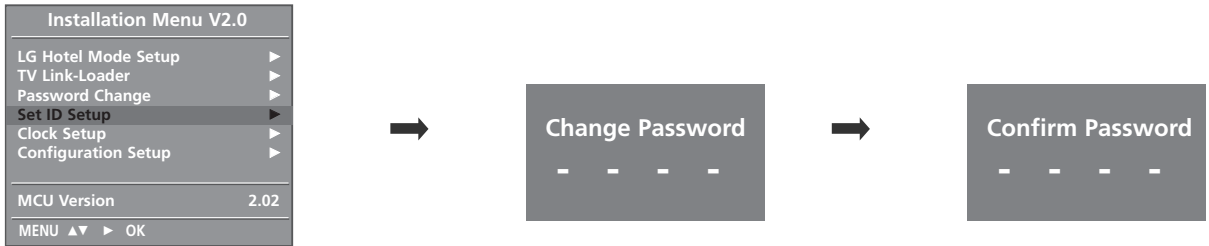

- 1 Use the ▲ / ▼ button to select the Password Change and then press the ► button.
- 2 Enter four digit password.
- 3 Input the password again for confirmation.

Set ID Setup

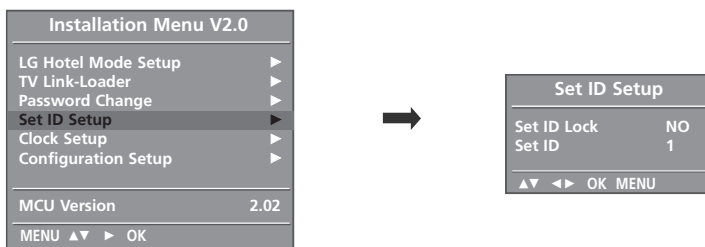

- 1 Use the ▲ / ▼ button to select the Set ID Setup.
 - **Set ID Lock**
 - Set the 'Set ID' item in 'Special' Menu whether to activate or not.
 - Set to Yes(Work) or No(Do Not Work).
 - **Set ID**
 - Set the 'Set ID' of TV Set with 1~99.

Installation Menu

Clock Setup

- To elaborate indoor condition in hotel rooms. The indicating luminous LED Clock helps guests to figure out time without turning on TV. Moreover, the level of luminance of LED Clock is adjustable according to each circumstances.

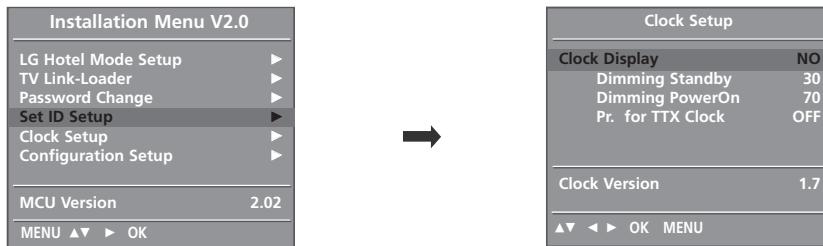

- 1 Press the ▲ / ▼ button to select the Clock Display.
- 2 You can select 'YES' or 'NO' by pressing ▶ button.
 - After selecting 'YES', you can adjust sub menu.
 - **Standby Dimming value** Range: 0~99
 - **Poweron Dimming value** Range: 0~99
- 3 PR. for TTX Clock.
You can adjust the Program to take clock information from Teletext when the AC Power is on. The default value is OFF. When the power is off. When you install in the Hotel you can adjust the Program according to the Hotel system.

! NOTE

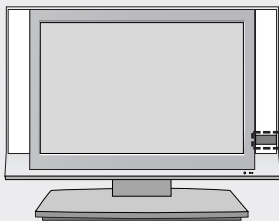

The indication of Front Clock LED Display is selectable.

Installation Menu

Configuration setup

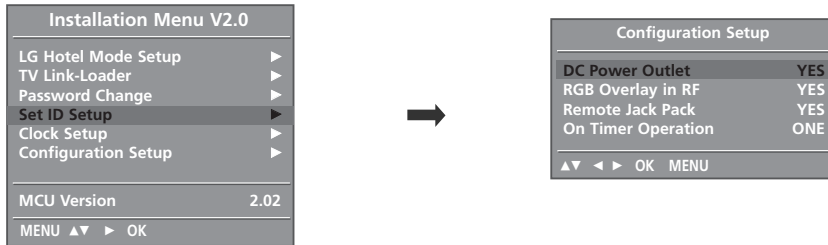

(1) DC Power Outlet

- It is a mode to decide whether to output DC or not for power supply to IB Box in Installation Menu. We offer a output terminal in one Pin of RS232C Jack for the use of communication.

- 1 You can select 'YES' or 'NO' by pressing ► button.
 - When select 'YES' the 5V is forwarded through the port, alternatively when select 'NO' the 5V is not transmitted.)

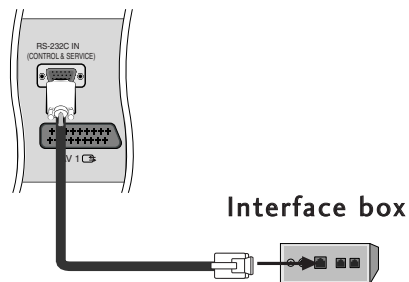

Type of Connector; D-Sub 9-Pin Male

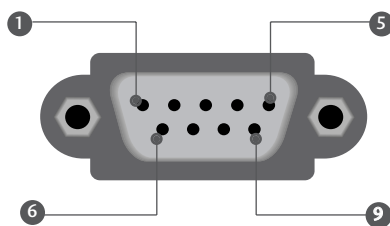

Male connector on box, viewed towards connector.

No.	Pin Name
1	No connection
2	RX
3	TX
4	IR-Out
5	GND
6	No connection
7	Power Output (5V Standby output)
8	No connection
9	No Connection

Installation Menu

(2) RGB Overlay In RF

- It is a mode to select whether to display RGB Data together on RF image or not. When 'RGB Overlay In RF' is set to 'Yes', Overlay Mode get to 'Enable' and you can see RGB Data signal as well as general RF Image.

(3) Remote Jack Pack

- It is a mode to set whether to use RJP(Remote Jack Pack) or not. When 'Remote Jack Pack' is set to 'Yes', the function to convert or separate Image and Sound automatically according to RJP Control signal is activated.

- This Function is available on *HIZ22 models.

(4) On Timer Operation

- The On Timer automatically switches the set to standby at the preset time.
- You can set the On Timer once or daily at the preset time.

External Speaker Interface

- Used for external speaker from "built-in audio-amp" of current input source (for bathroom speaker application).
Output power is 1W, 3.5mm phone-jack interface.