

 **FUJIFILM**

**digital**  
Tools for the imagination.

**xD**  
xD-Picture Card™

**Exif Print**

  
PictBridge



DIGITAL CAMERA  
***FinePix S3 Pro***

**OWNER'S MANUAL**

This manual will show you how to use your  
FUJIFILM DIGITAL CAMERA FinePix S3 Pro correctly.  
Please follow the instructions carefully.

**1** Getting Ready

**2** Basic  
Photography

**3** Advanced  
Photography

**4** Advanced  
Features Playback

**5** Settings

**6** Connection

## Warning

To prevent fire or shock hazard, do not expose the unit to rain or moisture.

### For customers in the U.S.A.

**Tested To Comply  
With FCC Standards  
FOR HOME OR OFFICE USE**

### FCC Statement

This device complies with part 15 of the FCC Rules. Operation is subject to the following two conditions: (1) This device may not cause harmful interference, and (2) this device must accept any interference received, including interference that may cause undesired operation.

### CAUTION

This equipment has been tested and found to comply with the limits for a Class B digital device, pursuant to Part 15 of the FCC Rules. These limits are designed to provide reasonable protection against harmful interference in a residential installation. This equipment generates, uses, and can radiate radio frequency energy and, if not installed and used in accordance with the instructions, may cause harmful interference to radio communications. However, there is no guarantee that interference will not occur in a particular installation. If this equipment does cause harmful interference to radio or television reception, which can be determined by turning the equipment off and on, the user is encouraged to try

to correct the interference by one or more of the following measures:

- Reorient or relocate the receiving antenna.
- Increase the separation between the equipment and receiver.
- Connect the equipment into an outlet on a circuit different from that to which the receiver is connected.
- Consult the dealer or an experienced radio/TV technician for help.

You are cautioned that any changes or modifications not expressly approved in this manual could void the user's authority to operate the equipment.

### Notes on the Grant:

To comply with Part 15 of the FCC rules, this product must be used with a Fujifilm-specified ferrite-core video cable, IEEE 1394 cable, USB cable and DC supply cord.

### For customers in Canada

### CAUTION

This Class B digital apparatus complies with Canadian ICES-003.

**Please read the Safety Notes (⇒P.141) and make sure you understand them before using the camera.**

## EC Declaration of Conformity

We

Name: Fuji Photo Film (Europe) G.m.b.H.  
Address: Heesenstrasse 31  
40549 Dusseldorf, Germany

declare that the product

Product Name: FUJIFILM DIGITAL CAMERA FinePix S3 Pro  
Manufacture's Name: Fuji Photo Film Co., Ltd.  
Manufacture's Address: 26-30, Nishiazabu 2-chome, Minato-ku,  
Tokyo 106-8620, Japan

is in conformity with the following Standards

Safety: EN60065  
EMC: EN55022: 1998 Classe B  
EN55024: 1998  
EN61000-3-2: 1995 + A1:1998 + A2:1998

following the provision of the EMC Directive (89/336/EEC, 92/31/EEC and 93/68/EEC) and Low Voltage Directive (73/23/EEC).

CE

Dusseldorf, Germany

November 1, 2004

Place

Date

Signature/Managing Director



Bij dit produkt zijn batterijen geleverd. Wanneer deze leeg zijn, moet u ze niet weggooien maar inleveren als KCA

# Contents

Warning .....	2	Top display panel .....	12
EC Declaration of Conformity .....	3	LCD monitor .....	12
Preface .....	7	Rear display panel .....	13
Accessories included .....	8	Viewfinder display .....	15
Camera parts and features .....	9		

## 1 Getting Ready

ATTACHING THE STRAP .....	16
MOUNTING THE CAMERA LENS .....	17
Using CPU Nikkor lenses other than G-type lenses .....	18
Lens compatibility .....	19
CHARGING THE BATTERIES .....	21
LOADING THE BATTERIES .....	22
INSERTING THE MEDIA .....	24
CHECKING THE BATTERY CHARGE .....	25
TURNING ON AND OFF / SETTING THE DATE AND TIME .....	26
CORRECTING THE DATE AND TIME / CHANGING THE DATE ORDER .....	27
SELECTING THE LANGUAGE .....	28
DIOPTRER ADJUSTMENT .....	29
LCD ILLUMINATOR .....	29

## 2 Basic Photography

BASIC OPERATION GUIDE .....	30
Command dials .....	33
TAKING PICTURES (P Auto-Multi Program) .....	34
Shooting with the camera held on end (vertically) .....	36
NUMBER OF AVAILABLE SHOTS .....	37
■ Standard number of shots for the media .....	37
AF-ASSIST ILLUMINATOR .....	38
SITUATIONS WHERE AUTOFOCUS MAY NOT WORK AS EXPECTED .....	39
USING AF LOCK .....	40
Ⓢ TAKING PICTURES WITH AE LOCK .....	41
DEPTH OF FIELD CHECK BUTTON .....	42
CCD PLANE INDICATOR .....	42

### PLAYBACK MODE

VIEWING THE IMAGES (L PLAYBACK) .....	43
Single-frame playback .....	43
Selecting images .....	43
Playback zoom .....	44

## 3 Advanced Photography

### FOCUS SETTINGS

FOCUS SETTINGS .....	45
■ Focus-related custom settings .....	45
SELECTING THE FOCUS MODE .....	46
■ Focus modes .....	46
SELECTING THE AF AREA MODE .....	47
■ The displays shown in the viewfinder and on the top display panel are shown below. ....	47
SELECTING THE FOCUS AREA .....	48
MANUAL FOCUS .....	49

### RELEASE MODES

S SINGLE-FRAME .....	50
----------------------	----

CONTINUOUS SHOOTING .....	50
SELF-TIMER PHOTOGRAPHY .....	51
MULTIPLE EXPOSURE .....	52
METERING SYSTEMS .....	54
Matrix (10-segment) metering .....	54
Center-weighted metering .....	54
Spot metering .....	54
ISO SENSITIVITY .....	55

### EXPOSURE MODES

P AUTO-MULTI PROGRAM .....	56
Program chart .....	57
S SHUTTER-PRIORITY AUTO .....	58
A APERTURE-PRIORITY AUTO .....	59
M MANUAL .....	60
Bulb photography ( <b>bulb</b> ) .....	61
EX EXPOSURE COMPENSATION .....	63
OKT AUTO EXPOSURE BRACKETING .....	64

### FLASH PHOTOGRAPHY

FLASH PHOTOGRAPHY .....	66
SETTINGS FOR FLASH PHOTOGRAPHY .....	66
BUILT-IN FLASH .....	67
■ Flash control modes that can be used with the built-in flash .....	67
SYNCHRO MODES AND THEIR FEATURES .....	68
⚡ FRONT SYNCHRO MODE .....	68
⚡ SLOW SLOW SYNCHRO MODE .....	68
⚡ REAR REAR SYNCHRO MODE .....	69
⚡ RED-EYE REDUCTION MODE .....	69
⚡ SLOW RED-EYE REDUCTION SLOW SYNCHRO MODE .....	69
TAKING PICTURES USING THE BUILT-IN FLASH .....	70
■ Effective range of the built-in flash .....	71
LENSES THAT CAN BE USED WITH THE BUILT-IN FLASH .....	72
FLASH EXPOSURE COMPENSATION .....	73
NIKON FLASH UNITS THAT CAN BE USED .....	74

### PHOTOGRAPHY FUNCTION MENU

USING THE FUNCTION MENU WHEN TAKING PICTURES .....	76
WHITE BALANCE .....	77
QUALITY .....	78
RECORDED PIXELS .....	79
FILM SIMULATION .....	79
DYNAMIC RANGE .....	80
COLOR .....	80
TONE .....	81
SHARPNESS .....	81
AF AREA .....	82
FUNCTION LOCK .....	82
FUNCTION RESET .....	83

## 4 Advanced Features Playback

### PLAYBACK FUNCTION MENU

USING THE FUNCTION MENU .....	84
HISTOGRAM .....	85
ERASING SINGLE-FRAME .....	86

## Contents

SINGLE-FRAME PROTECT .....	87
MULTI-FRAME PLAYBACK .....	88
<b>PLAYBACK MENU</b>	
ERASING ALL FRAMES .....	89
PROTECTING IMAGES: SET ALL / RESET ALL .....	91
HOW TO SPECIFY PRINT OPTIONS (DPOF) .....	93
DPOF SET FRAME .....	94
DPOF (RESET ALL) .....	96
AUTOMATIC PLAYBACK .....	97
TRIMMING .....	98
*± LCD BRIGHTNESS .....	100
<b>5 Settings</b>	
SET-UP .....	101
USING THE SET-UP SCREEN .....	101
■ SET-UP menu options .....	102
IMAGE DISPLAY .....	103
Procedure when "PREVIEW" is set .....	103
Preview zoom .....	103
Histogram .....	103
Brightness warning and standard chart .....	103
SETTING THE CUSTOM WB .....	104
■ When the exposure is not measured correctly .....	105
COLOR SPACES .....	105
D-RANGE .....	105
AUTO ROTATE .....	106
FORMAT .....	106
FRAME NO. .....	106
DISCHARGING RECHARGEABLE BATTERIES .....	107
LIVE IMAGE .....	108
TWO-BUTTON RESET .....	109
CUSTOM SETTING (CSM) .....	110
Cancelling custom settings .....	110
■ Custom settings list .....	111
<b>6 Connection</b>	
CONNECTING TO A TV .....	113
USING THE AC POWER ADAPTER .....	113
CONNECTING TO A COMPUTER .....	114
USE AT DSC MODE .....	115
Disconnecting the camera .....	116
CONNECTING THE CAMERA DIRECTLY TO THE PRINTER — PictBridge FUNCTION .....	117
Specifying images for printing on the camera .....	117
Specifying images for printing without using DPOF (single-frame printing) .....	118
Disconnecting the printer .....	120
System Expansion Options .....	121
Accessories Guide .....	122
Notes on Using Your Camera Correctly .....	124
Cleaning the CCD .....	125
Notes on the Power Supply .....	129
Applicable Batteries .....	129
Notes on the Batteries .....	129
Using the AA-size Ni-MH Batteries .....	129
Notes on Using the Battery Charger .....	130
AC Power Adapter .....	130
Notes on the Media .....	131
Warning Displays .....	132
Troubleshooting .....	136
Specifications .....	138
Explanation of Terms .....	140
Safety Notes .....	141

## Preface

### ■ Test Shots Prior to Photography

For particularly important photographs (such as weddings and overseas trips), always take a test photograph and view the image to make sure that the camera is functioning normally.

● Fuji Photo Film Co., Ltd. cannot accept liability for any incidental losses (such as the costs of photography or the loss of income from photography) incurred as a result of faults with this product.

### ■ Notes on Copyright

Images recorded using your digital camera system cannot be used in ways that infringe copyright laws without the consent of the owner, unless intended only for personal use. Note that some restrictions apply to the photographing of stage performances, entertainments and exhibits, even when intended purely for personal use. Users are also asked to note that the transfer of memory cards (xD-Picture Card or Microdrive) containing images or data protected under copyright laws is only permissible within the restrictions imposed by those copyright laws.

### ■ Liquid Crystal

If the LCD monitor is damaged, take particular care with the liquid crystal in the monitor. If any of the following situations arise, take the urgent action indicated.

- If liquid crystal comes in contact with your skin  
Wipe the area with a cloth and then wash thoroughly with soap and running water.
- If liquid crystal gets into your eye  
Flush the affected eye with clean water for at least 15 minutes and then seek medical assistance.
- If liquid crystal is swallowed  
Flush your mouth thoroughly with water. Drink large quantities of water and induce vomiting. Then seek medical assistance.

### ■ Notes on Electrical Interference

If the camera is to be used in hospitals or aircrafts, please note that this camera may cause interference

to other equipment in the hospital or aircraft. For details, please check with the applicable regulations.

### ■ Handling Your Digital Camera

This camera contains precision electronic components. To ensure that images are recorded correctly, do not subject the camera to impact or shock while an image is being recorded.

### ■ Trademark Information

- and xD-Picture Card™ are trademarks of Fuji Photo Film Co., Ltd.
- IBM PC/AT is a registered trademark of International Business Machines Corp. of the U.S.A.
- Macintosh, Power Macintosh, iMac, PowerBook, iBook and Mac OS are trademarks of Apple Computer, Inc., registered in the U.S. and other countries.
- Adobe Acrobat® Reader® is a trademark of Adobe Systems Incorporated of the U.S.
- Microsoft, Windows, and the Windows logo are trademarks, or registered trademarks of Microsoft Corporation in the United States and/or other countries. Windows is an abbreviated term referring to the Microsoft® Windows® Operating System.
- \* The "Designed for Microsoft® Windows® XP" logo refers to the camera and the driver only.
- Other company or product names are trademarks or registered trademarks of the respective companies.

### ■ Explanation of Color Television System

NTSC: National Television System Committee, color television telecasting specifications adopted mainly in the U.S.A., Canada and Japan.

PAL: Phase Alternation by Line, a color television system adopted mainly by European countries and China.

### ■ Exif Print (Exif ver. 2.2)

Exif Print Format is a newly revised digital camera file format that contains a variety of shooting information for optimal printing.

### ◆ LCD cover ◆

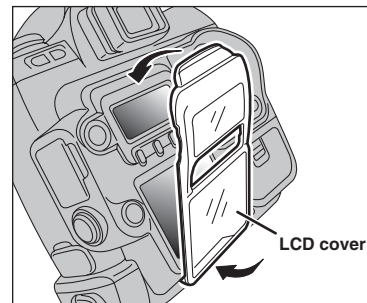

To prevent soiling or damage to the LCD monitor, attach the enclosed LCD cover to the camera when you are carrying or not using the camera. Attach the LCD cover by first fitting it into the grooves below the camera's LCD monitor.

## Accessories included

- **AA-size Ni-MH Batteries (HR-AA) (4)**

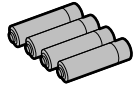

- **Battery charger BCH-NH2 (1)**

\*Plug-in and cord-attached types are provided depending on the intended country of use.

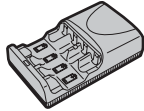

- **Strap (1)**



- **Accessory shoe cover (1)**

Fitted on the camera body

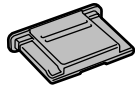

- **Eyepiece cap (1)**

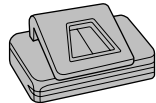

- **LCD cover (1)**

Fitted on the camera body



- **Camera body cap (1)**

Fitted on the camera body



- **Video cable (1)**

(approx. 1.5 m (4.9ft.), mini-plug (3.5 mm-dia.) to pin-plug cable)

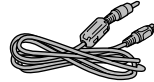

- **IEEE 1394 4-pin to 6-pin cable (1)**

(approx. 1.5 m (4.9ft.))

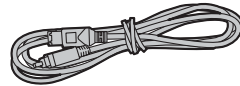

- **USB cable (mini-B) (1)**



- **Cable holder (1)**



- **Clamp filter (1)**

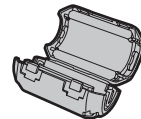

- **Synchronizing terminal cap (1)**

Fitted on the camera body

- **Remote release socket cap (1)**

Fitted on the camera body

- **Battery holder (1)**

Fitted on the camera body

- **CD-ROM: Software for FinePix AX (1)**

- **Owner's Manual (this manual) (1)**

- **Software Quick Start Guide (1)**

## Camera parts and features

\* Refer to the pages in parentheses for information on using the camera parts or features.

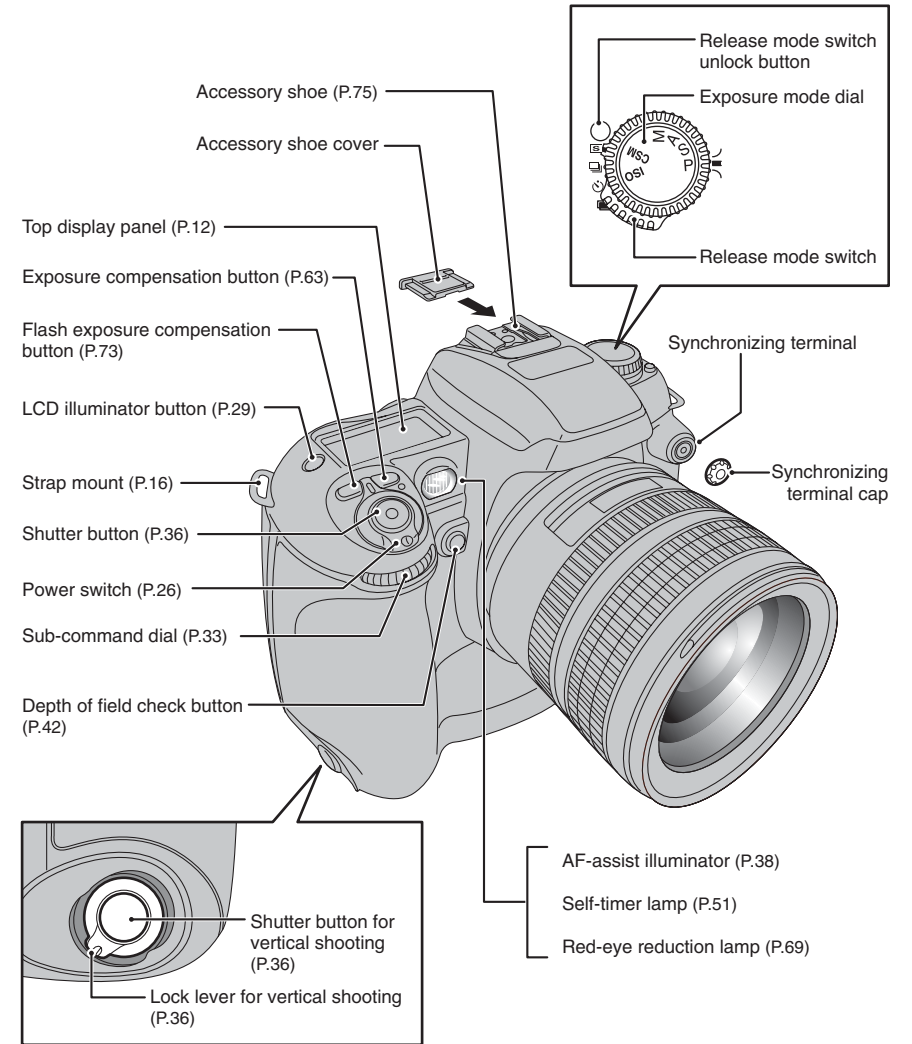

## Camera parts and features

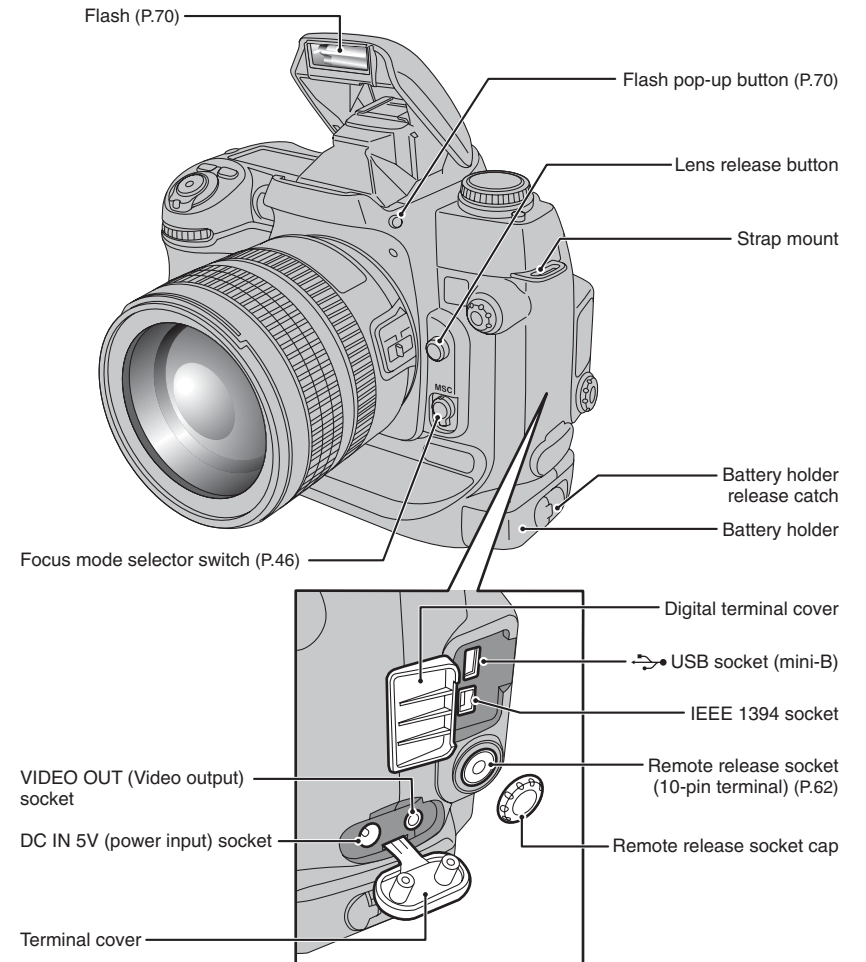
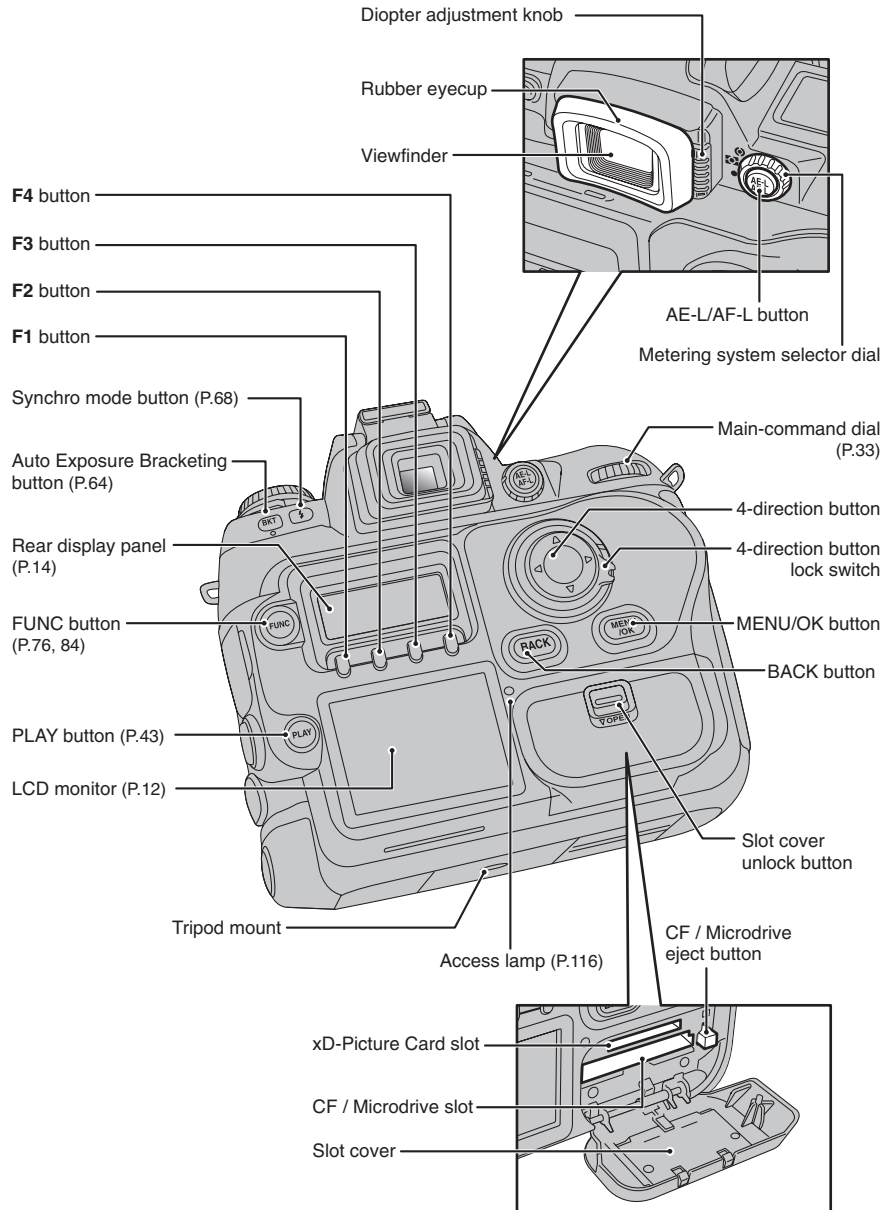

# Camera parts and features

## Top display panel

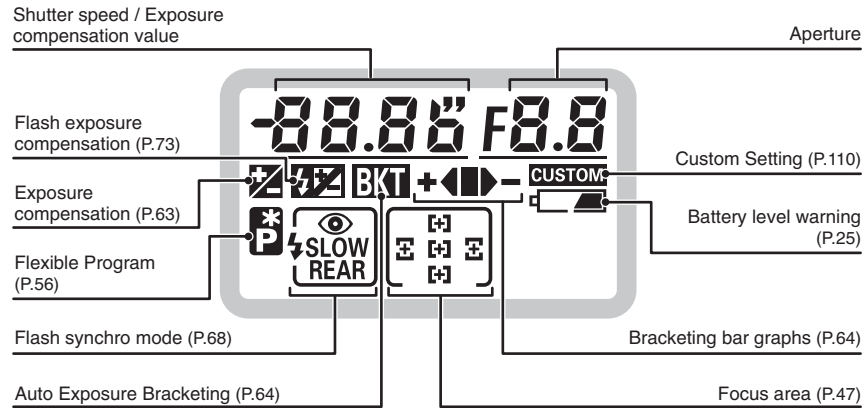

The LCD used in the top display panel will turn dark at high temperatures and will respond a little more slowly at low temperatures. However, it will operate normally again at normal temperatures.

## LCD monitor

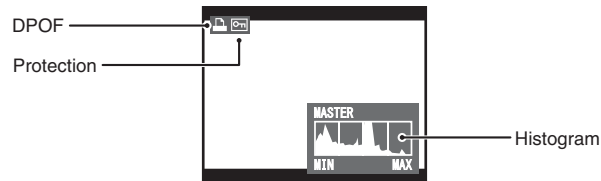

There may be some unevenness in the brightness at the bottom of the LCD monitor. This is due to variations in the lighting of the LCD itself and is not a fault.

## Rear display panel

### During shooting

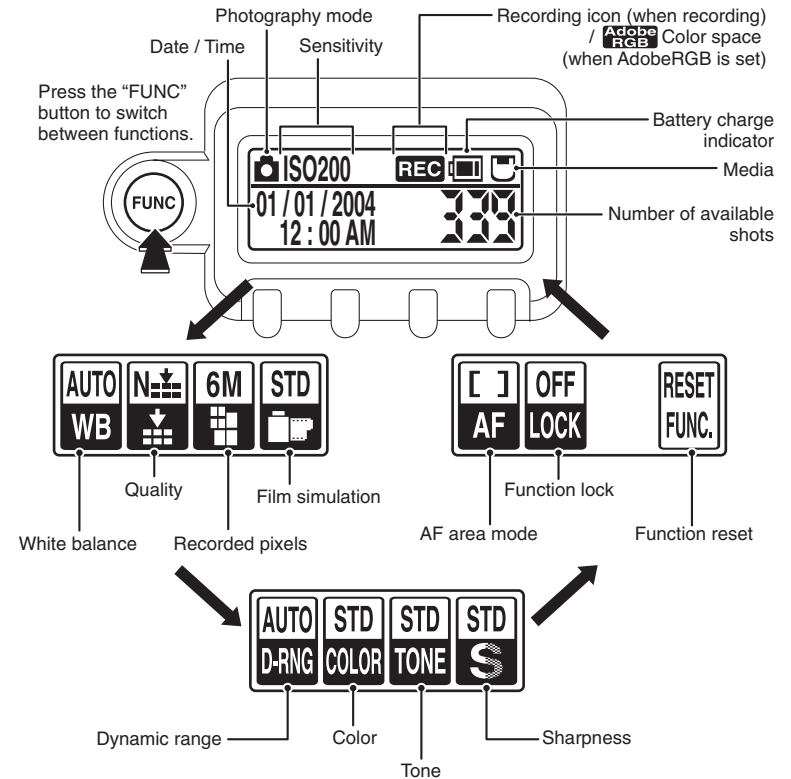

### Photographed image display: For checking

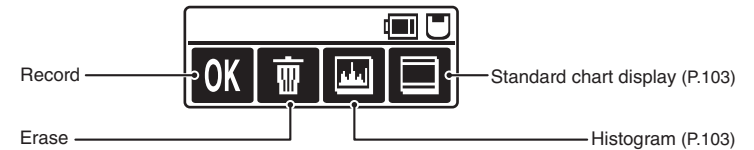

## Camera parts and features

### Rear display panel

#### ■ During playback

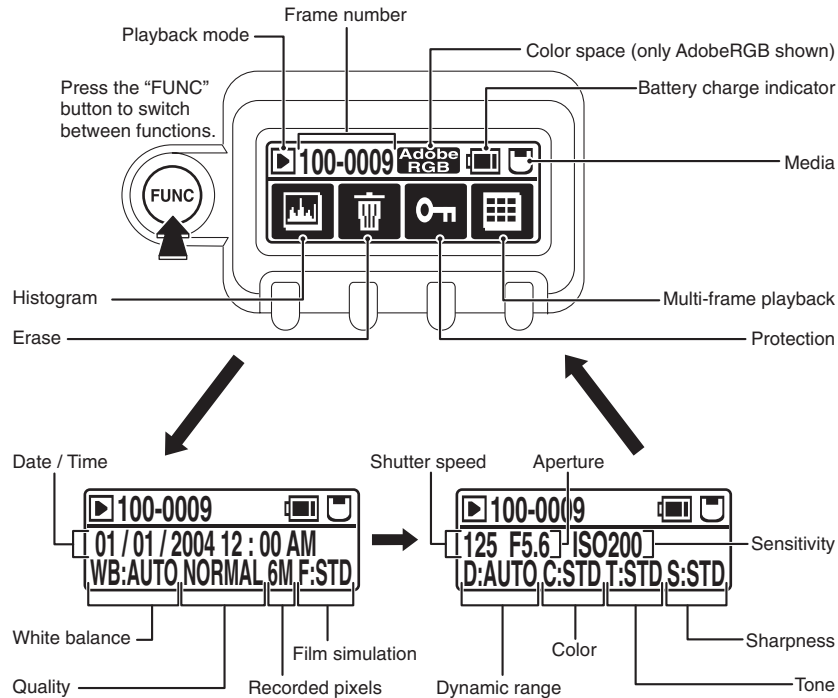

### Viewfinder display

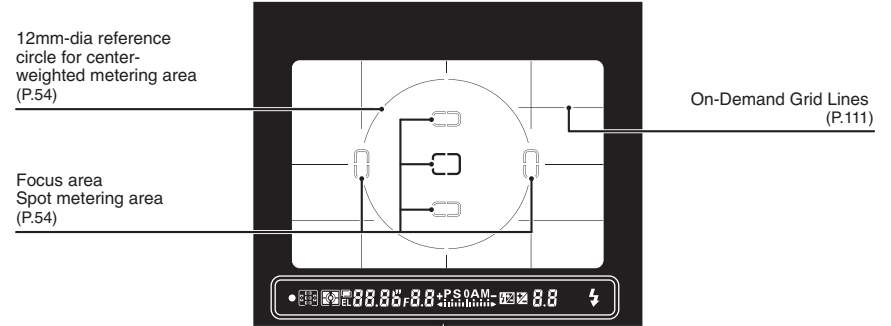

#### ● Viewfinder information display

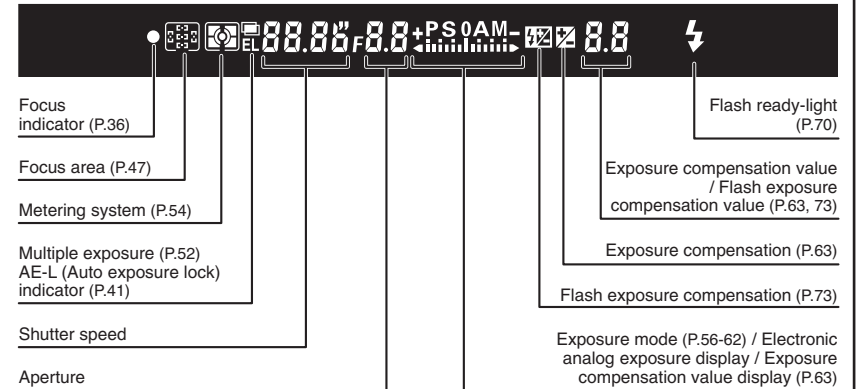

- ⚠ The viewfinder will be dark without battery power but brightens after installation of fresh batteries. This is not a malfunction.
- ⚠ The LCD panel in the upper part of the viewfinder (focus area and On-Demand Grid Lines) will become paler at high temperatures and will become darker and respond a little more slowly at low temperatures. However, it will operate normally again at normal temperatures.
- ⚠ The LCD panel in the viewfinder display (where the icons and numbers are displayed) will turn dark at high temperatures and will respond a little more slowly at low temperatures. However, it will operate normally again at normal temperatures.

#### ◆ About Advanced Focusing Screen Display ◆

The new Advanced Focusing Screen Display of the FinePix S3 Pro employs the convenient Vari-Brite Focus Area display system; it enables clear display of the focus brackets at the selected focus area in the viewfinder for easy identification. When the finder image is bright, the focus brackets are displayed in black and when the finder image is dark, the focus brackets are momentarily illuminated in red. The selected focus area can be identified easily in both bright and dark conditions with this function. Also, the new Advanced Focusing Screen Display allows the superimposition of On-Demand Grid Lines. The grid lines can be displayed by using Custom Setting Menu #2 (➔P.111). These grids assist you in composing the frame, in taking landscape pictures or in shifting/tilting PC-Nikkor lenses.

\* Due to characteristics of the LCD used in the Vari-Brite Focus Area display system, a thin line outside the selected focus area may also be displayed or the entire viewfinder may be illuminated in red under certain conditions. These are not malfunctions.



# 1 Getting Ready ATTACHING THE STRAP

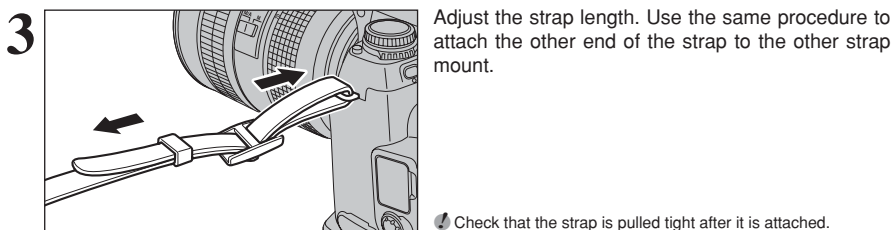
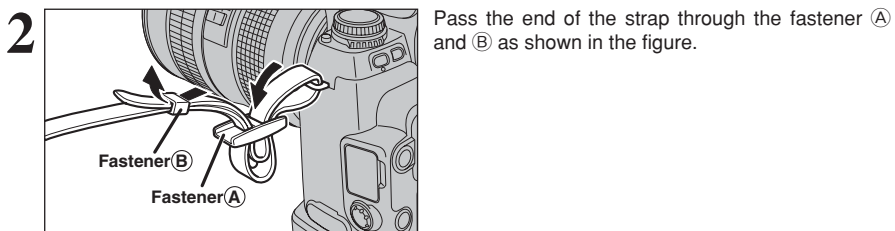
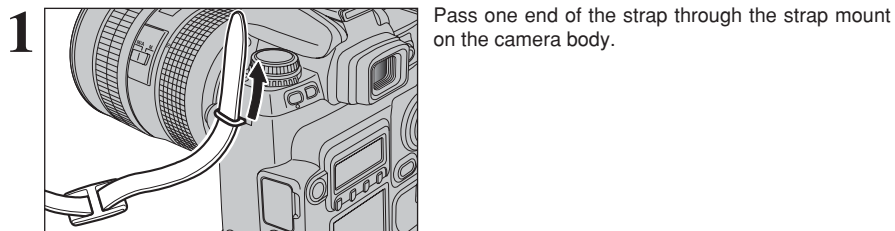

☛ Check that the strap is pulled tight after it is attached.

### ◆ Using the cable holder ◆

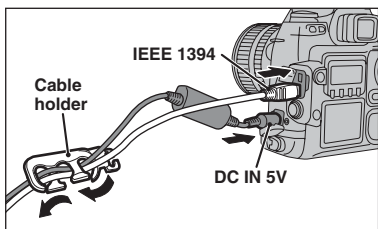

Feed the cables through the cable holder.

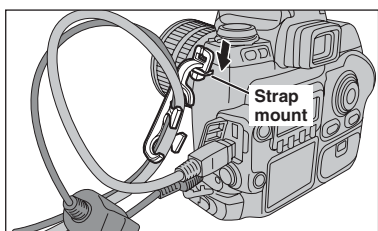

Attach the cable holder to the strap mount.

# MOUNTING THE CAMERA LENS

**1** Check the lens type.

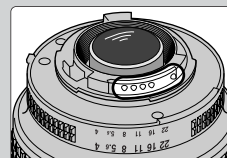

CPU contacts of CPU lens  
The lens is fitted with CPU  
signal contacts.

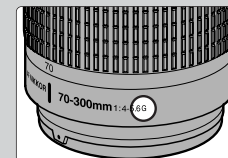

G-type Nikkor lens  
(without aperture ring)

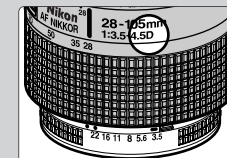

CPU Nikkor lens other  
than G-type  
(with aperture ring)

☛ See "Lens compatibility" (P.19) for details.

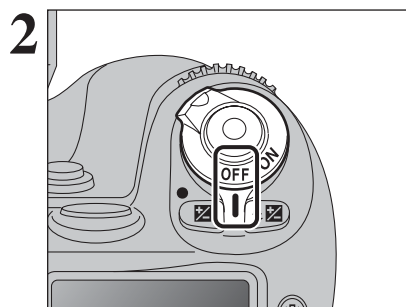

Set the Power switch to "OFF" to turn the camera off.

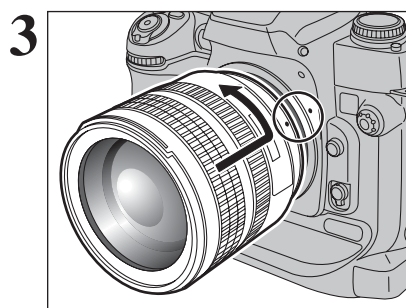

Position lens in the camera's bayonet mount so that the mounting indexes on lens and camera body are aligned, then twist lens counterclockwise until it locks into place.

- ☛ Always change the lens in an area free of dirt and dust.
- ☛ When attaching the lens, take care not to press the lens release button.
- ☛ When the lens is not attached or when a non-CPU Nikkor lens is attached and the power switch is turned on, "F- -" blinks in the top display panel and viewfinder, and the shutter cannot be released. See P.20 for a non-CPU lens.
- ☛ Take care not to mount the lens when it is at an angle to the camera as this can damage the lens mount on the camera.

## MOUNTING THE CAMERA LENS

### Using CPU Nikkor lenses other than G-type lenses

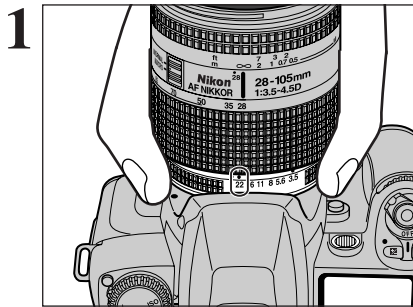

Set the aperture ring to the minimum aperture.

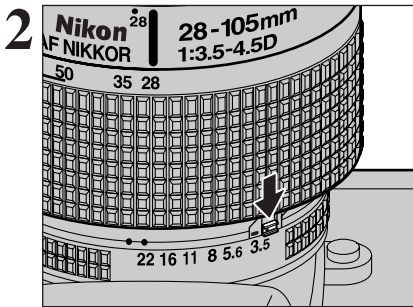

Lock the aperture ring. If you turn the camera on without first selecting the minimum aperture (the aperture setting with the largest number), "fE E" flashes on the top display panel and in the viewfinder, and the shutter will not operate.

#### ◆ Removing the lens ◆

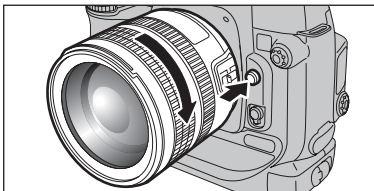

Push and hold the lens release button, then turn the lens clockwise.

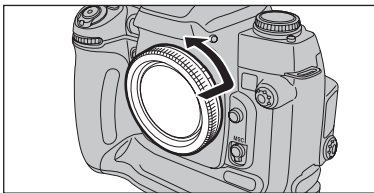

While the lens is removed from the camera, fit the camera body cap provided onto the camera to protect the inside of the camera and prevent soiling of the mirror and viewfinder screen. You can also use the Nikon BF-1A Body Cap.

### Lens compatibility

Use a CPU lens (except IX-Nikkor) with this camera. D- or G-type AF lenses give you access to all available functions (⇒P.17).

#### ■ Types of CPU lenses and other usable lenses/accessories

Lens/accessories	Mode			Focus mode		Exposure mode		Metering system		
	Autofocus	Manual with electronic rangefinder	Manual	Any mode other than M	M	Matrix		Center-Weighted, Spot*1		
						3D 10-segment	10-segment			
CPU Nikkor*2	D-type AF Nikkor*3, G-type AF Nikkor*3, AF-S, AF-I Nikkor	✓	✓	✓	✓	✓	✓	—	✓	
	PC Micro-Nikkor 85 mm f/2.8D*4	—	✓*5	✓	—	✓	✓	—	✓	
	AF-I/AF-S Teleconverter*6	✓*7	✓*7	✓	✓	✓	✓	—	✓	
	Non-D/G-type AF Nikkor (except AF Nikkor for F3AF)	✓	✓	✓	✓	✓	—	✓	✓	
	AI-P Nikkor	—	✓*8	✓	✓	✓	—	✓	✓	
Non-CPU Nikkor*9	AI-S or AI type Nikkor, Series-E, AI-modified Nikkor	—	✓*8	✓	—	✓*10	—	—	—	
	Medical-Nikkor 120 mm f/4	—	✓	✓	—	✓*11	—	—	—	
	Reflex-Nikkor	—	—	✓	—	✓*10	—	—	—	
	PC-Nikkor	—	✓*5	✓	—	✓*10	—	—	—	
	AI-S or AI type Teleconverters	—	✓*7	✓	—	✓*10	—	—	—	
	Bellows Focusing Attachment PB-6*12	—	✓*7	✓	—	✓*10	—	—	—	
Auto Extension Rings (PK-11A, PK-12, PK-13 and PN-11)	—	✓*7	✓	—	✓*10	—	—	—		

✓: Compatible, —: Incompatible

- \* 1 Spot metering area can be shifted with focus area selector (⇒P.54) with CPU Nikkor lens.
- \* 2 IX-Nikkor lenses cannot be attached.
- \* 3 This camera is compatible with the Vibration Reduction function of the VR Nikkor lens.
- \* 4 The camera's exposure metering and flash control system do not work properly when shifting and/or tilting the lens, or when using an aperture other than the maximum aperture.
- \* 5 Without shifting and/or tilting the lens.
- \* 6 Compatible with AF-S and AF-I Nikkor except AF-S 17-35 mm f/2.8D IF-ED, AF-S 28-70 mm f/2.8D IF-ED, AF-S 12-24mm f/4G, AF-S DX ED 17-55mm f/2.8G, AF-S DX ED 18-70mm f/3.5-4.5G, AF-S ED 24-85mm f/3.5-4.5G and AF-S VR ED 24-120mm f/3.5-5.6G.
- \* 7 With maximum effective aperture of f/5.6 or faster.
- \* 8 With maximum aperture of f/5.6 or faster.
- \* 9 Some lenses/accessories cannot be attached (⇒P.20).
- \* 10 With exposure mode set to Manual. The exposure meter cannot be used.
- \* 11 With exposure mode set to Manual and shutter speed set to 1/60 sec. or slower but the exposure meter cannot be used.
- \* 12 Can be mounted when used with the Nikon Auto extension ring.
  - Reprocopy Outfit PF-4 can be attached in combination with Nikon Camera Holder PA-4.

## MOUNTING THE CAMERA LENS

### ◆ G-type Nikkor and other CPU Nikkor lens ◆

- The G-type Nikkor lens has no aperture ring; aperture should be selected from camera body. Unlike other CPU Nikkor lenses, aperture does not need to be set to minimum (largest f-number).
- CPU Nikkor lenses other than G-type Nikkor lens have an aperture ring. Set the lens aperture to its minimum and lock. When the lens is not set to its minimum aperture setting and the power switch is turned on, "fE E" blinks in the top display panel and viewfinder and the shutter cannot be released.

### ◆ When a non-CPU lens is attached ◆

Set exposure mode to "M" Manual with a non-CPU lens (When other modes are selected, shutter cannot be released). The camera's exposure meter cannot be used and the aperture cannot be set using the Sub-command Dial when using non-CPU lenses. "F- -" appears in place of the aperture indication in the top display panel and viewfinder; set/confirm aperture using the lens aperture ring.

### ◆ Nikkor lenses/accessories that cannot be attached to the FinePix S3 Pro ◆

The following Nikkor lenses/accessories cannot be attached to the FinePix S3 Pro (otherwise camera body or lens may be damaged):

- TC-16A Teleconverter
- Non-AI lenses
- 400mm f/4.5, 600 mm f/5.6, 800 mm f/8 and 1200 mm f/11 with Focusing Unit AU-1
- Fisheye 6 mm f/5.6, 7.5 mm f/5.6, 8 mm f/8 and OP 10 mm f/5.6
- Old type 21 mm f/4
- K1, K2 ring, Auto Extension Ring PK-1, PK-11, Auto Ring BR-2, BR-4
- ED 180-600 mm f/8 (No. 174041-174180)
- ED 360-1200 mm f/11 (No. 174031-174127)
- 200-600 mm f/9.5 (No. 280001-300490)
- 80 mm f/2.8, 200 mm f/3.5 and TC-16 Teleconverter for F3AF
- PC 28 mm f/4 (No. 180900 or smaller)
- PC 35 mm f/2.8 (No. 851001-906200)
- Old type PC 35 mm f/3.5
- Old type Reflex 1000 mm f/6.3
- Reflex 1000 mm f/11 (No. 142361-143000)
- Reflex 2000 mm f/11 (No. 200111-200310)

## CHARGING THE BATTERIES

Charge the AA-size Ni-MH batteries (HR-AA).

### Batteries that can be charged

#### ● AA-size Ni-MH batteries (included)

- ⚠ Always use the battery charger BCH-NH2 bundled with the camera to charge Ni-MH batteries. Attempting to charge batteries other than those specified for use with the charger (such as manganese, alkaline or lithium batteries) can cause the batteries to burst or leak. This could result in a fire or injury and consequent damage to the surroundings.

1

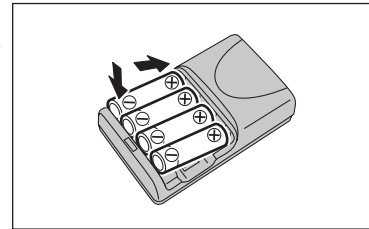

Load the Ni-MH batteries (included) into the battery charger BCH-NH2 bundled with the camera correctly as indicated by the polarity icons.

- ⚠ The Ni-MH batteries are not fully charged when purchased and must be fully charged before being used.
- ⚠ When first used after purchasing or when left unused for a long period, charge and discharge the battery using the camera's "Discharging rechargeable batteries" function and then recharge them (⇒P.107).
- ⚠ If the terminals of battery are soiled, it may not be possible to charge them. Clean the battery terminals and battery charger terminals with a clean, dry cloth.

2

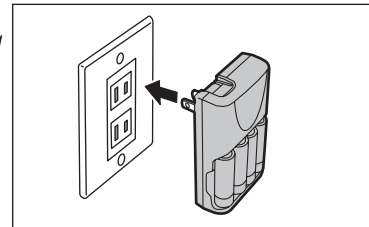

\*Plug-in and cord-attached types are provided depending on the intended country of use.

Plug the battery charger into a power outlet to begin charging. After completing the charging, the charging lamp turns off. Unplug the battery charger from the power outlet when it is not in use.

- ⚠ If Ni-MH batteries are charged repeatedly before they are fully discharged, the battery charge indicator will appear while there is still ample charge remaining in the batteries. At that time, discharge and recharge them several times using the camera's "Discharging rechargeable batteries" function (⇒P.107).
- ⚠ The socket-outlet shall be installed near the equipment and shall be easily accessible.
- ⚠ The shape of the plug and socket-outlet depends on the country of use.

# LOADING THE BATTERIES

## Compatible Batteries

- AA-size Ni-MH batteries (HR-AA) (4)

### ◆ How to use the battery ◆

- **Use only Ni-MH (nickel-metal hydride) batteries.**
- Never use the following types of batteries, as they could cause serious problems such as battery fluid leakage or overheating:
  1. Batteries with split or peeling outer casings
  2. Combinations of different types of batteries or new and used batteries together
- Soil (such as fingerprints) on the battery terminals makes the batteries charge less reducing the number of images they will allow you to take. Carefully wipe the battery terminals with a soft dry cloth before loading.
- See P.129 for other notes on using batteries.
- When first used after purchasing or left unused for a long period, the time for which AA-size Ni-MH rechargeable batteries can be used may be shorter. You are advised to check the detailed information provided on P.129 and then charge the batteries before using the camera (within 1 week).

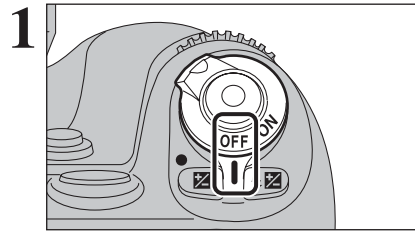
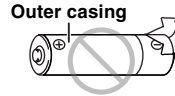

1 Set the Power switch to "OFF" to turn the camera off.

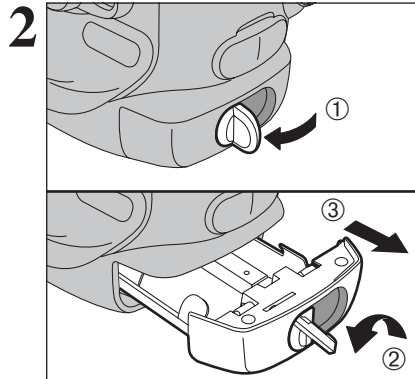

- ① Lift out the battery holder release catch.
- ② Turn the battery holder release catch counterclockwise to unlock the battery holder.
- ③ Pull the battery holder out.

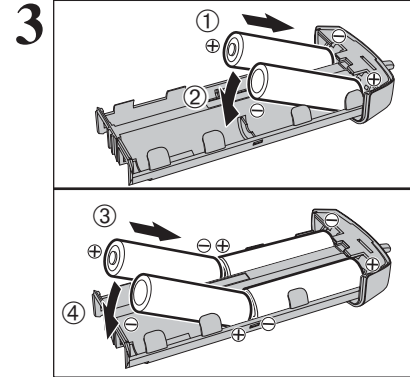

Load the AA-size Ni-MH rechargeable batteries in the direction indicated by the ⊕ and ⊖ labels on the holder. Align the battery ends with the terminals in the sequence shown in the figure and then slowly push them into the place.

- Remove the batteries more easily by pushing the batteries upwards from the gap at the opposite end from the battery holder release catch.

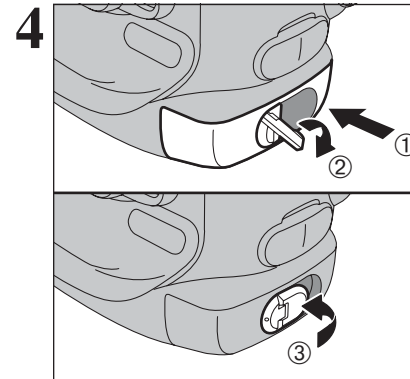

4 Push the battery holder in and hold it in place as you turn the battery holder release catch clockwise to securely lock the battery holder.

## INSERTING THE MEDIA

Use either **xD-Picture Card** or **CF/Microdrive** as recording media in the FinePix S3 Pro.

- If an **xD-Picture Card** and a **CF/Microdrive** are inserted at the same time, images will be recorded onto the media selected as the "MEDIA" (⇒P.102).
- Data cannot be copied between the two media types on the FinePix S3 Pro.

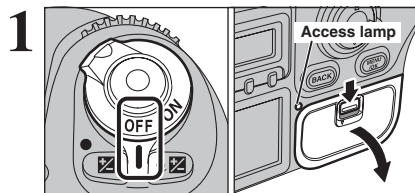

Set the Power switch to "OFF" and check that the access lamp is off. Then open the slot cover.

Never open the slot cover while the camera is on. This could destroy the image data or damage the media itself.

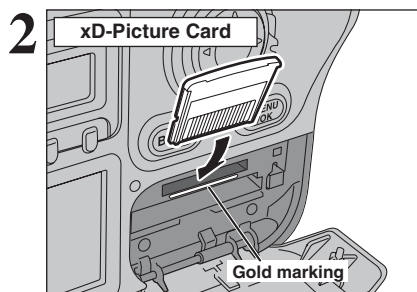

Align the gold marking on the **xD-Picture Card** slot with the gold contact area on the **xD-Picture Card** and push the card firmly all the way into the slot.

- ⚠ Insert only the appropriate media types into the **xD-Picture Card** and **CF/Microdrive** slots. Inserting the incorrect media will damage the camera or media.
- ⚠ If the media is oriented incorrectly, it will not go all the way into the slot. Do not apply force when inserting an **xD-Picture Card** or **CF/Microdrive**.
- ⚠ If the media is not fully inserted into the slot, "CARD ERROR" appears.

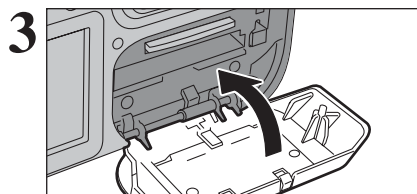

Close the slot cover.

### ◆ How to replace the xD-Picture Card ◆

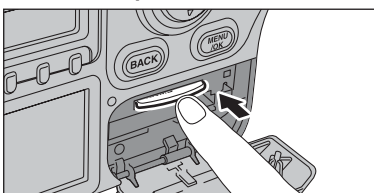

Push the **xD-Picture Card** into the slot and then slowly remove your finger. The lock is released and the **xD-Picture Card** is pushed out.

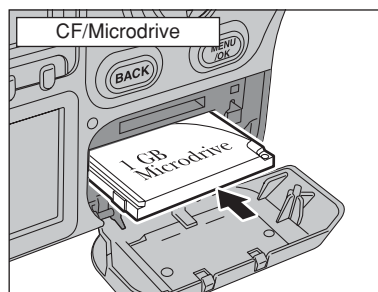

Push the **CF/Microdrive** firmly all the way into the **CF/Microdrive** slot. Compatibility is listed on Fujifilm website: <http://home.fujifilm.com/products/digital/>

### ◆ How to replace the CF/Microdrive ◆

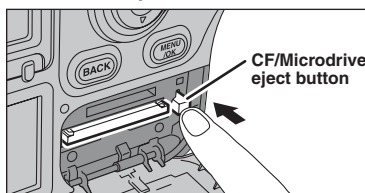

Open the slot cover, press the **CF/Microdrive eject button** and remove the **CF/Microdrive**.

- ⚠ When storing **CF/Microdrives**, always use the special protective case.

## CHECKING THE BATTERY CHARGE

Turn the camera on and check the battery charge indicator.

### Top display panel

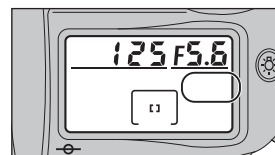

① No icon  
Batteries charged.

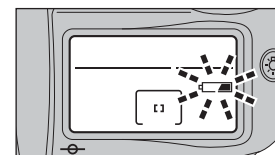

② Blinking  
No remaining battery charge.  
Camera shutting down.

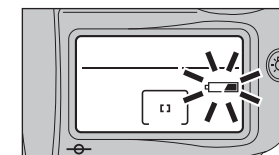

③ Lit  
Lights when there is no remaining battery charge and the camera shutdown procedure has been completed. The batteries must be replaced.

### Rear display panel

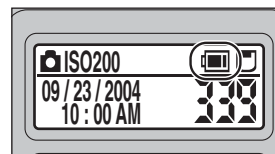

- ① Lit
- ② Lit
- ③ Blinking

- ① There is ample charge in the batteries.
- ② The batteries are flat. Have replacement batteries ready.
- ③ The batteries are fully depleted. You must replace the batteries.

- ⚠ If you turn the camera on again after the icon in ③ has been displayed, the icon in ① may reappear but there is actually no charge left in the batteries and they must be replaced.

- If the camera loses power while it is shooting or saving an image, it cannot save the photographed image. Note the battery level carefully when shooting long-exposure images (e.g. bulb photography) or when shooting images that will take some time to save (continuous shooting or shots with the quality set to "HIGH").
- Use the optional AC adapter (AC-5VX) when camera is used for long periods for indoor shots, etc. The camera displays no battery level icons when the AC adapter is used.

### ◆ Auto Power Off Function ◆

If you leave the camera turned on without using it, this function automatically turns the camera off (⇒P.112). When the Auto Power Off function has turned the camera off, restore power to the camera by pressing the shutter button on the top of the camera down halfway or by pressing the LCD illuminator button.

- ⚠ Auto Power Off cannot be cancelled using the shutter button for vertical shooting.

## TURNING ON AND OFF / SETTING THE DATE AND TIME

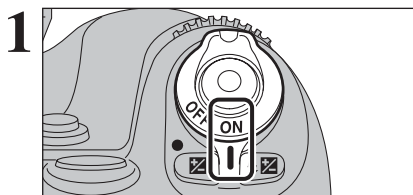

To turn the camera on, set the Power switch to "ON".  
To turn the camera off, set the Power switch to "OFF".

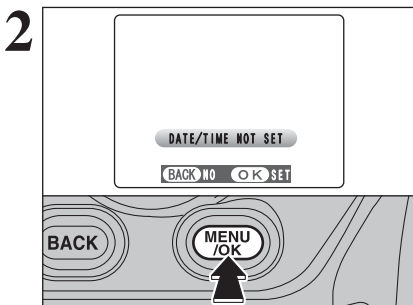

After purchasing the camera, first time when turning camera on, the date and time are cleared. Press the "MENU/OK" button to set the date and time.

- ④ If the message (see figure at left) does not appear, refer to "Correcting the date and time" (P.27) and check and correct the date and time settings.
- ④ The message also appears when the batteries have been removed and the camera has been left for a long period.
- ④ To set the date and time later, press the "BACK" button.
- ④ If you do not set the date and time, this message will appear each time you turn the camera on.

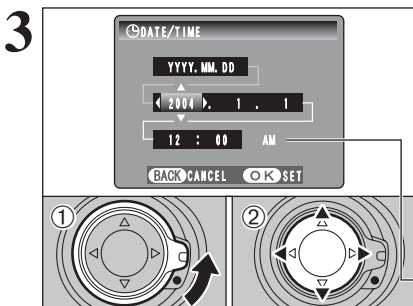

- ① Unlock the 4-direction button.
- ② Press "◀" or "▶" to select Year, Month, Day, Hour or Minute and then press "▲" or "▼" to adjust the selected setting.

- ④ Holding down "▲" or "▼" changes the numbers continuously.
- ④ When the time displayed passes "12:00", the AM/PM setting changes.

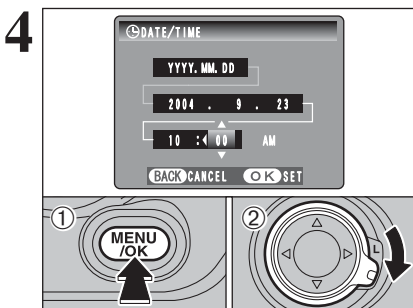

- ① Once you have set the date and time, press the "MENU/OK" button.
- ② When you have finished the procedure, lock the 4-direction button to prevent accidental improper use.

- ④ At the time of purchase and after leaving the camera for a long period with the batteries removed, settings such as the date and time are cleared. Once the AC power adapter has been connected or the batteries have been loaded for 2 days or more, the date and time settings will be retained for roughly 6 months even when the camera has no power (batteries removed and AC power adapter disconnected).

## CORRECTING THE DATE AND TIME / CHANGING THE DATE ORDER

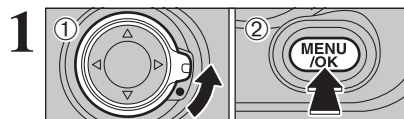

- ① Unlock the 4-direction button.
- ② Press the "MENU/OK" button.

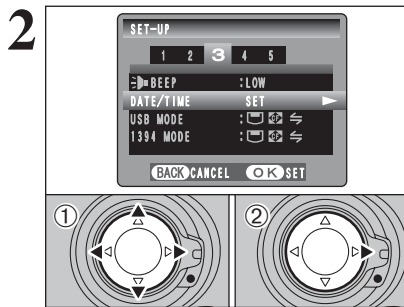

- ① Press "◀" or "▶" to move to option 3 and then press "▲" or "▼" to select "DATE/TIME".
- ② Press "▶".

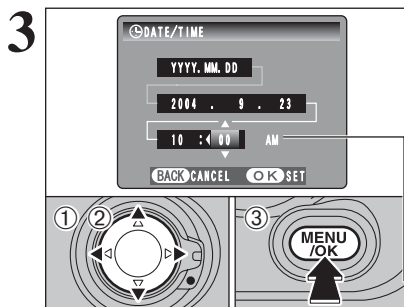

- ### Correcting the date and time
- ① Press "◀" or "▶" to select Year, Month, Day, Hour or Minute.
  - ② Press "▲" or "▼" to correct the setting.
  - ③ Always press the "MENU/OK" button after the settings are completed.

- ④ Holding down "▲" or "▼" changes the numbers continuously.
- ④ When the time displayed passes "12:00", the AM/PM setting changes.

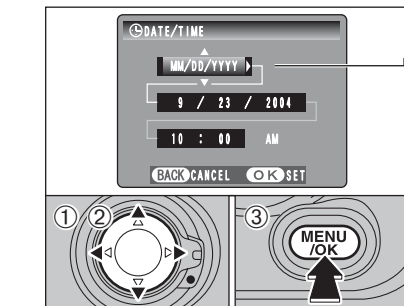

- ### Changing the date order
- ① Press "◀" or "▶" to select the date order.
  - ② Press "▲" or "▼" to set the order. Refer to the table below for details of the settings.
  - ③ Always press the "MENU/OK" button after the settings are completed.

Date order	Explanation
YYYY.MM.DD	Displays the date in the "year. month. day" format.
MM/DD/YYYY	Displays the date in the "month / day / year" format.
DD.MM.YYYY	Displays the date in the "day. month. year" format.

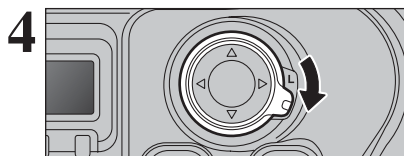

When you have finished the procedure, lock the 4-direction button to prevent accidental improper use.

## SELECTING THE LANGUAGE

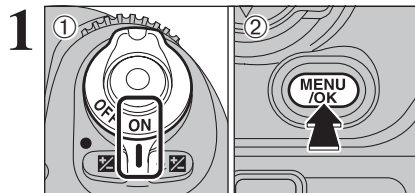

- ① Turn the camera on.
- ② Press the "MENU/OK" button to display the SET-UP screen.

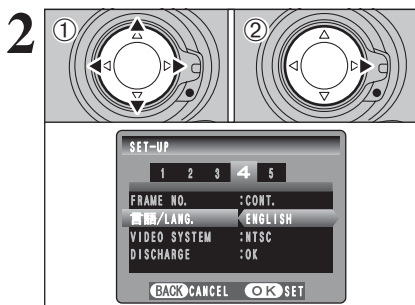

- ① The "SET-UP" screen appears. Press "◀" or "▶" to move to option 4 and then press "▲" or "▼" to select "言語/LANG."
- ② Press "▶" to select "ENGLISH", "FRANCAIS", "DEUTSCH", "ESPAÑOL", "ITALIANO", "中文" or "日本語". Press "▶" to cycle through the language settings.

- 🔧 The screens in this manual are shown in English.
- 🔧 See P.102 for more information on the "SET-UP" menu.

## DIOPTER ADJUSTMENT / LCD ILLUMINATOR

### DIOPTER ADJUSTMENT

The finder diopter enables near- or far-sighted photographers to adjust the eyepiece diopter to suit their vision.

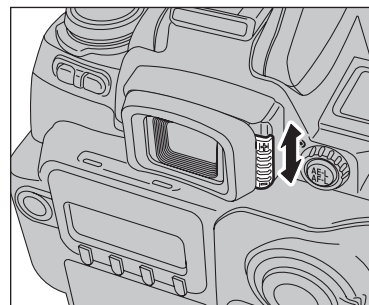

While looking through the viewfinder, adjust the position of the diopter adjustment knob until the focusing frame or the image in the viewfinder appears sharpest.

- The diopter setting can be adjusted from  $-2.0 \text{ m}^{-1}$  (shortsighted) to  $+1.0 \text{ m}^{-1}$  (farsighted). Nikon also provides 9 types of diopter adjustment lens ranging from  $-5 \text{ m}^{-1}$  to  $+3 \text{ m}^{-1}$ .

Since the diopter adjustment knob is located next to the viewfinder, be careful not to poke yourself in the eye with your finger or fingernail while sliding the knob.

### LCD ILLUMINATOR

Displays in the top and rear display panels can be confirmed in the dark with the LCD illuminator.

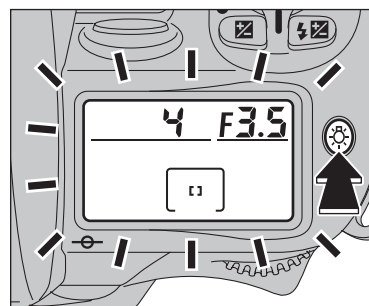

When you press the "☼" LCD illuminator button, the top and rear display panels light up.

- Display panel illumination turns off in the following situations:
  - When you press the "☼" LCD illumination button again
  - When you release the shutter
  - When the Auto Power Off function turns the camera off

- 🔧 Pressing the shutter button down halfway temporarily turns display panel illumination off.

CSM 14: The illuminator can be set to come on when any button is pressed (➡P.112).

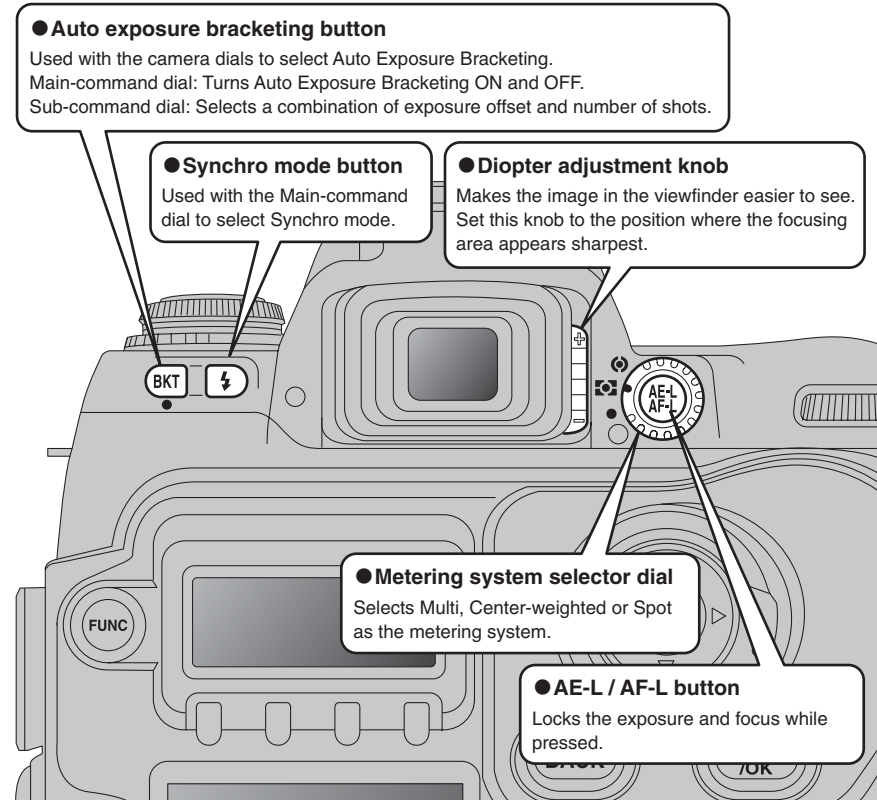
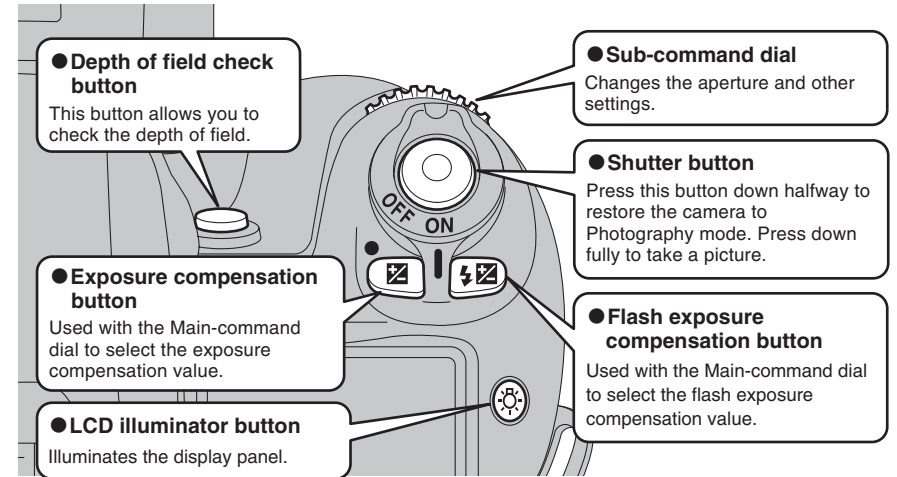
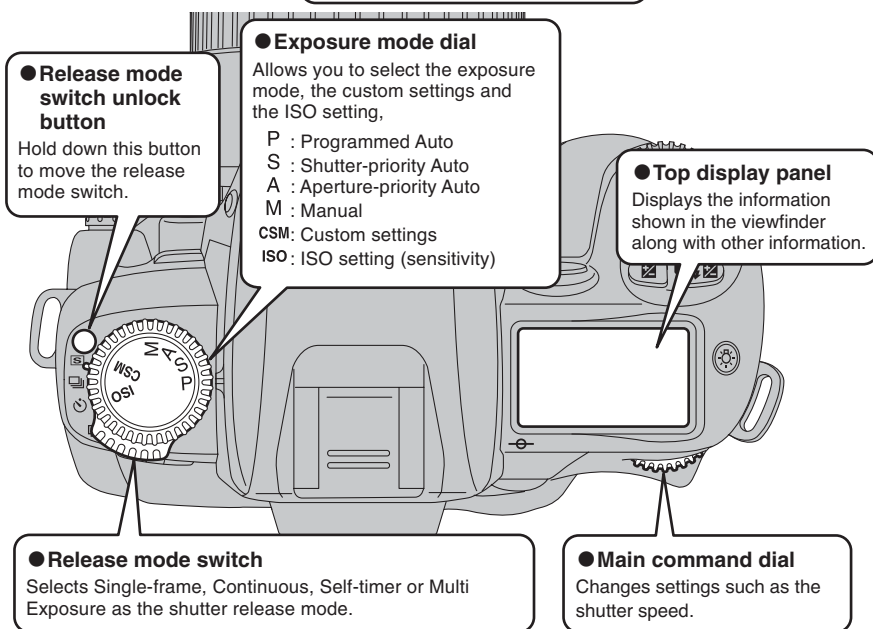
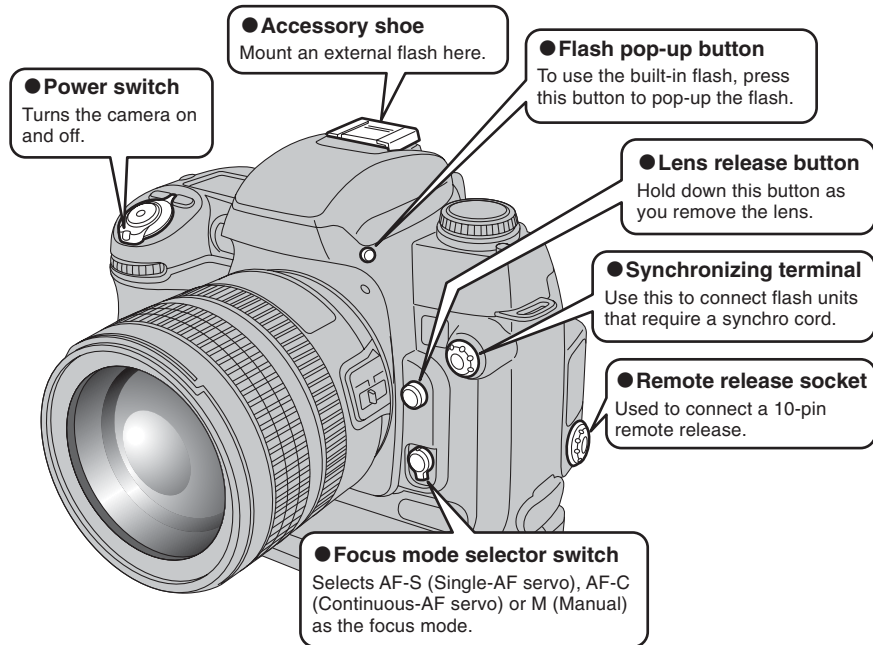



# BASIC OPERATION GUIDE

- FUNC button**  
Selects the information displayed on the rear display panel.
- F1 to F4 buttons**  
Use these buttons to select items in the rear display panel.
- Rear display panel**  
Displays information during shooting or playback.
- 4-direction button**  
Use this button to select menu options or the focus area.
- 4-direction button lock switch**  
Release this switch to use the 4-direction button.
- MENU/OK button**  
Press this button to confirm an action in the menu screen.
- BACK button**  
Press this button to cancel an action in the menu screen.
- PLAY button**  
Switches playback display on and off.
- Access lamp**  
Lights during media access.

### ● Playback, Menu and SET-UP Operations

```

    graph TD
        Photography --> LCD_monitor[LCD monitor OFF]
        LCD_monitor --> Shutter_halfway[Shutter button pressed halfway]
        Shutter_halfway --> Photography
        Shutter_halfway --> Playback
        Shutter_halfway --> Menu
        Shutter_halfway --> SET_UP
        Playback --> LCD_monitor
        Menu --> LCD_monitor
        SET_UP --> LCD_monitor
        LCD_monitor --> PLAY
        LCD_monitor --> MENU_OK
    
```

**Playback**  
 Frame advance : ◀▶  
 Playback zoom : ▲▼

**Menu**  
 ① Menu option selection : ◀▶  
 ② Setting selection : ▲▼  
 ③ Confirmation : MENU/OK  
 Cancel : BACK

**SET-UP**  
 ① Option selection : ▲▼  
 ② Setting selection : ◀▶

## Command dials

The FinePix S3 Pro's Main- and Sub-command dials are used alone or in combination with other buttons to select/set various functions or modes.

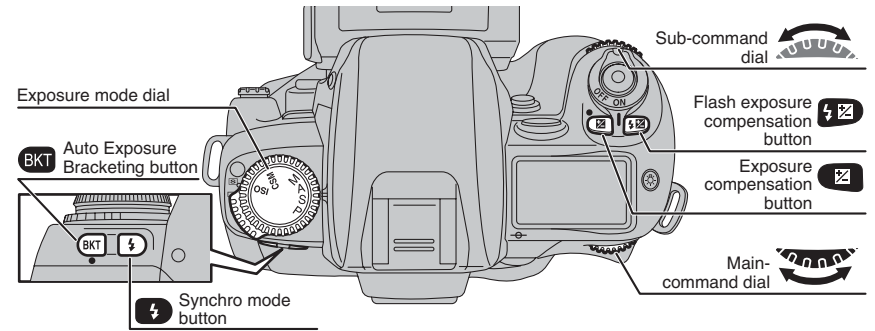

Setting	Exposure mode setting	Procedure
Program shift	"P"	Main 
Shutter speed setting	"S, M"	Main Slower  Faster
Aperture setting	"A, M"	Sub Open  Close
Exposure compensation amount	"P, S, A, M"	Main +
Auto Exposure Bracketing ON/OFF	"P, S, A, M"	Main +
Number of shots and exposure offset for Auto Exposure Bracketing		Sub +
Synchro mode setting	"P, S, A, M"	Main +
Flash exposure compensation amount		Main +
Sensitivity setting	"ISO"	Main 
Custom setting option selection	"CSM"	Main 
Custom setting option modification		Sub 

## TAKING PICTURES (P Auto-Multi Program)

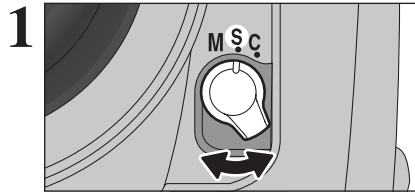

1 Set the focus mode selector switch to “S” (Single AF Servo).

Make sure to turn the focus mode selector switch until it clicks into position.

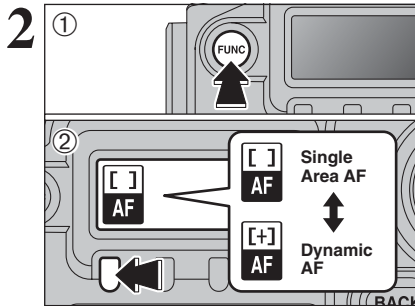

1 Press the “FUNC” button to display the AF setting on the rear display panel.  
2 Press the “F1” button to select “Single area AF”.

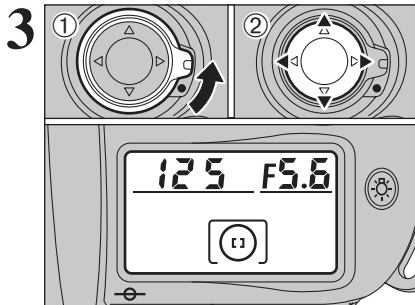

1 Unlock the 4-direction button.  
2 Press “◀”, “▶”, “▲” or “▼” to position the focusing area in the center.

The selected focus area indicator appears on the top display panel, in the viewfinder display and on the viewfinder screen (⇒P.47).

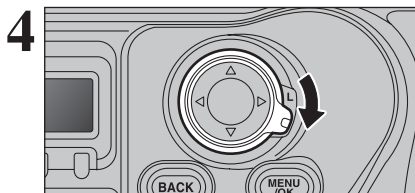

4 Lock the 4-direction button to prevent accidental improper use.

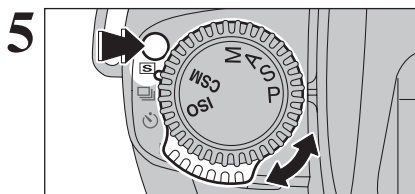

5 Hold down the release mode switch unlock button and set the release mode switch to “S” (Single-frame).

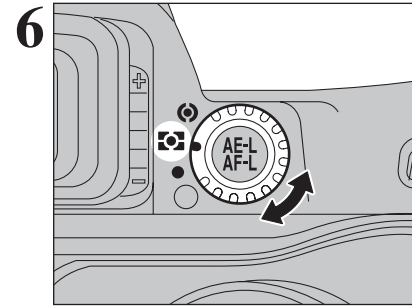

6 Set the metering system selector dial to “☒” (Matrix metering).

Matrix metering indication “☒” appears in the viewfinder.

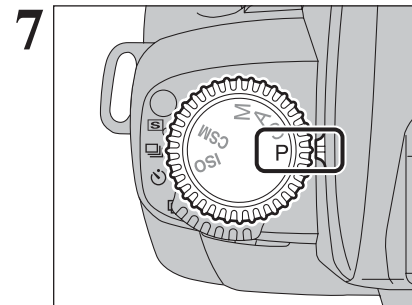

7 Set the Exposure mode dial to “P” (Auto-Multi Program).

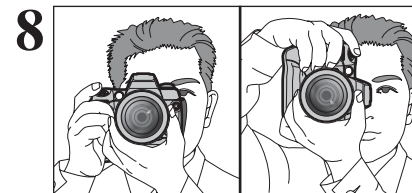

8 Brace your elbows against your body and hold the camera with both hands.

When shooting with the camera held vertically, see the section on vertical shooting (⇒P.36).  
Take care not to obscure the lens with your fingers or the shoulder strap.



9 Position the central focus area over the subject.

If the subject is outside the focus area, either move the focus area or take the picture using the AF Lock function (⇒P.40).

## TAKING PICTURES (P Auto-Multi Program)

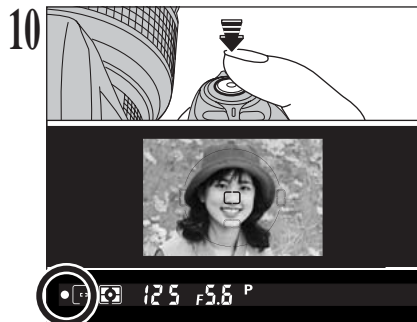

Press the shutter button down halfway to focus the shot. The focus indicator “●” appears in the viewfinder display.

⚠ If the focus indicator is flashing, the camera cannot focus and the shutter will not release.

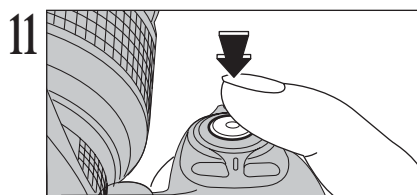

Without releasing the shutter button, press it down all the way (fully pressed) to take the shot.

### Shooting with the camera held on end (vertically)

The shutter button for vertical shooting makes taking pictures in this mode as convenient as normal shooting.

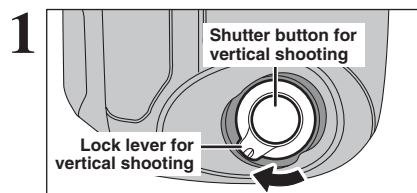

Unlock the shutter button for vertical shooting.

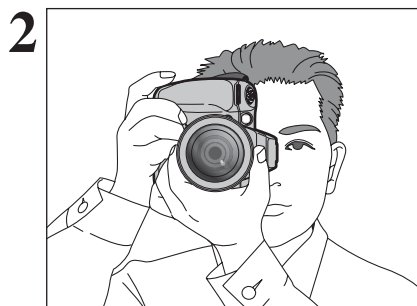

Hold the camera vertically to take the picture.

⚠ When you are not using the shutter button for vertical shooting, engage the lock lever for vertical shooting to prevent the shutter button from being pressed by mistake.  
⚠ Auto Power Off cannot be cancelled using the shutter button for vertical shooting. Press the shutter button on the top of the camera to restore power to the camera.

## NUMBER OF AVAILABLE SHOTS

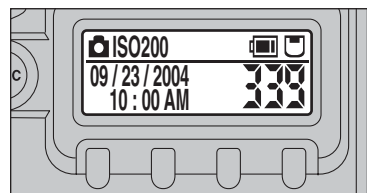

The number of available shots is displayed on the rear display panel.

⚠ See P.78-79 for information on changing the number of recorded pixels/Quality (compression ratio) setting.  
⚠ The factory default settings set at shipment are 6M and N (Quality: NORMAL).

### Standard number of shots for the media

Because the amount of data needed to record an image varies slightly depending on the type of subject, the number of available shots may not decrease after an image is recorded, or may decrease by 2 in some cases. Also, the difference between the standard number of shots and the actual number of available shots increases for media with a higher capacity.

Number of recorded pixels	RAW CCD-RAW		12M 4256 × 2848		6M 3024 × 2016		3M 2304 × 1536		1M 1440 × 960	
	D-RANGE WIDE	D-RANGE STANDARD	FINE	NORMAL	FINE	NORMAL	FINE	NORMAL	FINE	NORMAL
Quality Mode	Approx. 25 MB	Approx. 13 MB	Approx. 4.7 MB	Approx. 2.4 MB	Approx. 3.0 MB	Approx. 1.5 MB	Approx. 1.7 MB	Approx. 880 KB	Approx. 1 MB	Approx. 520 KB
Image File Size	0	1	3	6	5	10	8	17	14	29
DPC-16 (16 MB)	1	2	6	13	10	20	17	35	30	59
DPC-32 (32 MB)	2	4	13	26	21	42	36	72	61	120
DPC-64 (64 MB)	5	9	26	53	42	84	72	144	122	241
DPC-128 (128 MB)	10	19	53	107	85	169	146	290	245	484
DPC-256 (256 MB)	20	39	107	214	170	339	292	580	491	967
DPC-512 (512 MB)	13	27	73	146	116	232	200	396	338	671
Microdrive (340 MB)	41	81	220	437	349	698	597	1173	995	1932
Microdrive (1 GB)										

\* Number of available shots for formatted media.

## AF-ASSIST ILLUMINATOR

When the subject is dark and the shutter button is pressed down halfway, the camera's AF-assist illuminator automatically turns on and enables autofocus operation in a dark environment.

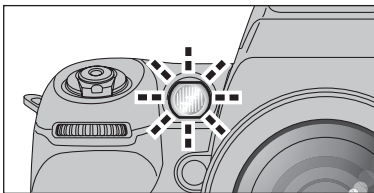

AF-assist illuminator automatically turns on in the following situations:

Focus mode is Single AF servo, AF Nikkor lens is used, subject is dark and center focus area is selected or Dynamic AF Mode with Closest Subject Priority is activated.

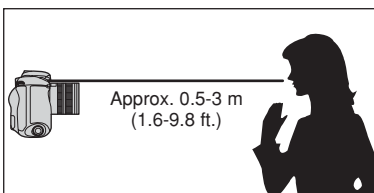

Focal length of the usable AF Nikkor lens is 24-200 mm and the distance range of the AF-assist illuminator is approx. 0.5-3 m (1.6-9.8 ft.).

**CSM 15:** AF-assist illuminator can be cancelled (➔P.112).

When the AF-assist illuminator is used continuously, illumination is limited temporarily to protect the firing tube. The illumination restarts after a few moments. Also, when the AF-assist illuminator is used repeatedly in a short period of time, be careful not to touch the AF-assist illuminator lamp because it may have become hot.

### ◆ Nikon flash units and active assist illuminator ◆

If you use an SB-28/28DX, SB-27, SB-26, SB-25, SB-24, SB-800 or SB-600 Nikon flash to take pictures when the conditions for active assist illuminator are met, the active assist illuminator on the Nikon flash automatically fires. With other Nikon flash models, the AF-assist illuminator on the camera automatically lights.

### ◆ Lenses for which vignetting occurs ◆

- Autofocus using the camera's AF-assist illuminator cannot be performed due to vignetting with following lenses at shooting distance within 1m (3.3 ft):
  - AF Micro 200 mm f/4 IF-ED
  - AF-S 17-35 mm f/2.8 IF-ED
  - AF 18-35 mm f/3.5-4.5 ED
  - AF 20-35 mm f/2.8 IF
  - AF 24-85mm f/2.8-4D
  - AF-S DX 18-70mm f/3.5-4.5G
  - AF-S VR ED 24-120mm f/3.5-5.6G
  - AF 24-120 mm f/3.5-5.6 IF
  - AF-S 28-70 mm f/2.8 IF-ED
  - AF Micro 70-180 mm f/4.5-5.6 ED
  - AF 24-85 mm f/2.8-4
  - AF-S DX ED 12-24mm f/4G
  - AF-S ED 24-85mm f/3.5-4.5G
  - AF ED 28-200mm f/3.5-5.6G
- At shooting distances of 2 meters or less, the AF-S DX ED 17-55mm f/2.8G (IF) cannot be used for autofocus photography where the AF-assist illuminator is used.
- Autofocus using the camera's AF-assist illuminator cannot be performed due to vignetting with AF-S 80-200 mm f/2.8 IF-ED, AF 80-200 mm f/2.8 ED, AF VR 80-400 mm f/4.5-5.6 ED, AF-S VR ED 70-200mm f/2.8D and AF-S VR ED 200-400mm f/4G.

## SITUATIONS WHERE AUTOFOCUS MAY NOT WORK AS EXPECTED

Autofocus may not work as expected in the following situations. In such situations, focus manually using the clear matte field or focus on a different subject located at the same distance, use AF lock (➔P.40) then recompose.



**Low-contrast scenes**

For example, where the subject is wearing clothing the same color as a wall or other background.

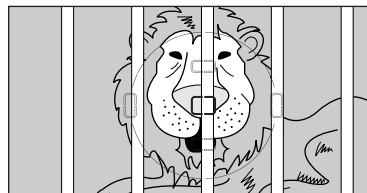

**Scenes with subjects within the focus brackets located at different distances from the camera**

For example, when shooting an animal in a cage or a person in a forest.

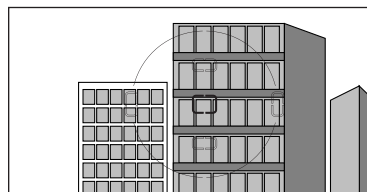

**Patterned subject or scene**

For example, building windows.

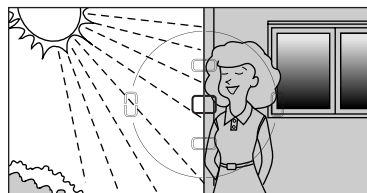

**Scenes with pronounced differences in brightness within the focus brackets**

For example, when the sun is in the background and the main subject is in shadow.

## USING AF LOCK



If you take a shot with this type of composition using Single-area AF with the focus area in the center, the subjects (the two people in this case) are outside the focus area and will not be in focus.



Move the camera slightly so that one of the subjects is in the AF frame.



Keep the shutter button pressed down halfway (AF lock) and check that the focus indicator "●" is lit in the viewfinder display.

● If you are using the "AF-C" focus mode, hold the shutter button down halfway and press the "AE-L/AF-L" button (⇒P.41).

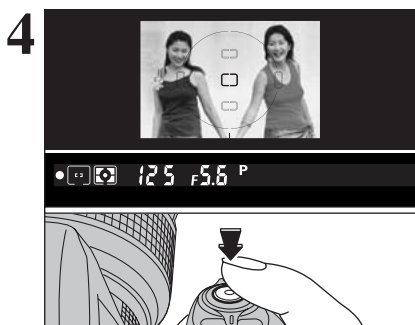

Continue to hold the shutter button down halfway (AF lock). Move the camera back to the original image and then fully press down on the shutter button.

● You can reapply the AF lock as many times as you like before releasing the shutter.  
● The AF lock operates in all photography modes and can be used to ensure excellent results.

### ◆ When AF (Auto Focus) does not focus the shot ◆

- Position the focus area over another subject at roughly the same distance and press the shutter button down halfway. Then recompose the shot and take the picture.
- You can also set the focus and take the shot by selecting "M" (manual) as the focus mode.

## TAKING PICTURES WITH AE LOCK

AE lock allows you to set the exposure for a specific subject in your shot. This technique is useful when brightness of your subject differs greatly from its surroundings.

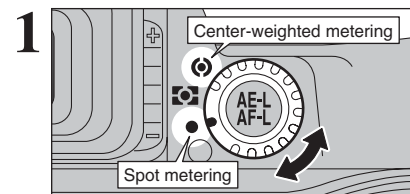

Set the metering system selector dial to "●" Center-weighted or "●" Spot metering.

● Matrix metering is not recommended since the effect of the Auto Exposure Lock cannot be effectively attained.

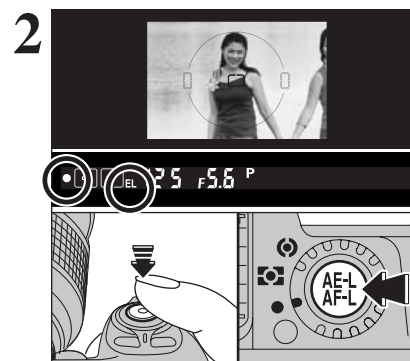

Position the focus area over the subject you want correctly exposed, press and hold the shutter button down halfway and then press the "AE-L/AF-L" button. The "EL" (exposure lock) indicator appears in the viewfinder.

● The exposure and focus are locked as long as the "AE-L/AF-L" button is held down (default setting).

● If you press the "AE-L/AF-L" button in the "AF-S" or "AF-C" focus mode when the shot is not in focus, the exposure is locked with the shot out of focus. Always check that the focus indicator "●" is lit.

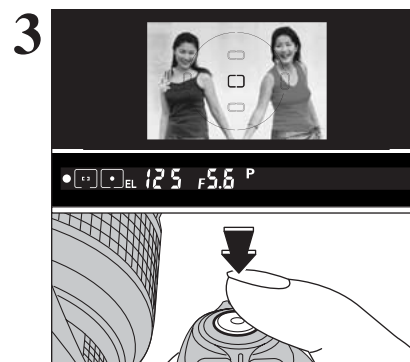

While keeping the "AE-L/AF-L" button pressed, recompose, focus and shoot.

● Because the settings are maintained after you take the shot for as long as the "AE-L/AF-L" button is held down, you can keep the same settings as you recompose the shot.

● The following functions can be operated while the "AE-L/AF-L" button is kept pressed:

1. In "P" exposure mode: Sets program shift.
2. In "S" exposure mode: Changes the shutter speed.
3. In "A" exposure mode: Changes the aperture.

● Rotating the metering system selector to another setting does not change the metering system during Auto Exposure Lock operation. Release the AE lock.

**CSM 5:** Auto Exposure Lock can be set to be activated by pressing the shutter button down halfway (⇒P.111).

**CSM 9:** The operation performed when the "AE-L/AF-L" button is pressed can be modified (⇒P.111).

Operation: AF/AE lock (default setting), AE lock only, AF lock only, AE lock maintained, AF operation

## DEPTH OF FIELD CHECK BUTTON / CCD PLANE INDICATOR

### DEPTH OF FIELD CHECK BUTTON

Depress the depth of field check button to confirm the depth of field through the viewfinder.

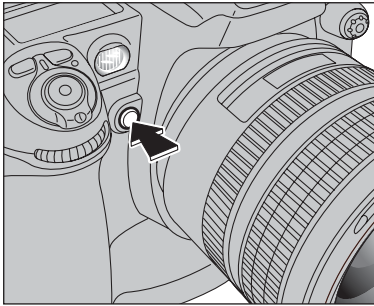

Pressing the depth of field check button stops the lens down to the aperture controlled in "P" Auto-Multi Program or "S" Shutter-Priority Auto exposure mode, and down to the aperture selected in "A" Aperture-Priority Auto or "M" Manual exposure mode. By looking through the viewfinder, the approximate depth of field with the given aperture can be confirmed.

When you press the depth of field check button, the shutter speed display and LCD illumination both turn off.

### CCD PLANE INDICATOR

The CCD plane indicator shows the position of the CCD plane inside the camera body.

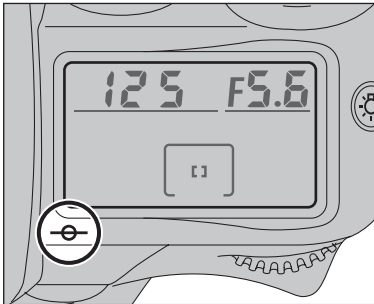

The CCD plane indicator shows the standard line of the shooting distance and indicates the position of the CCD plane inside the camera body. Use this indicator when actually measuring camera-to-subject distance, e.g. in close-up photography. The exact distance from the lens mounting flange to the CCD plane is 46.5 mm.

## PLAYBACK MODE VIEWING THE IMAGES (▶ PLAYBACK)

### Single-frame playback

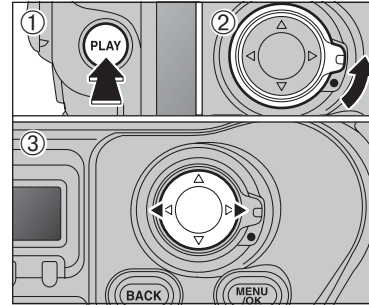

- Press the "PLAY" button to view your images.
- Unlock the 4-direction button.
- Press "▶" to scan forward through your images. Press "◀" to scan backwards.

Pressing the "PLAY" button displays the last image photographed.

### Selecting images

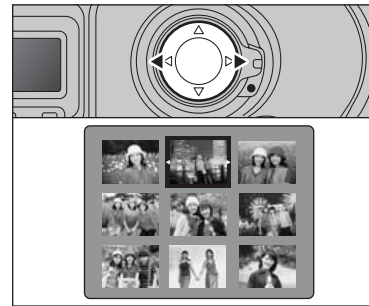

To select images on the thumbnail lists screen, hold down "◀" or "▶" for approx. 1 second during playback.

### Displaying the photography data

Press the "FUNC" button during image playback to check the photography data for the currently displayed frame.

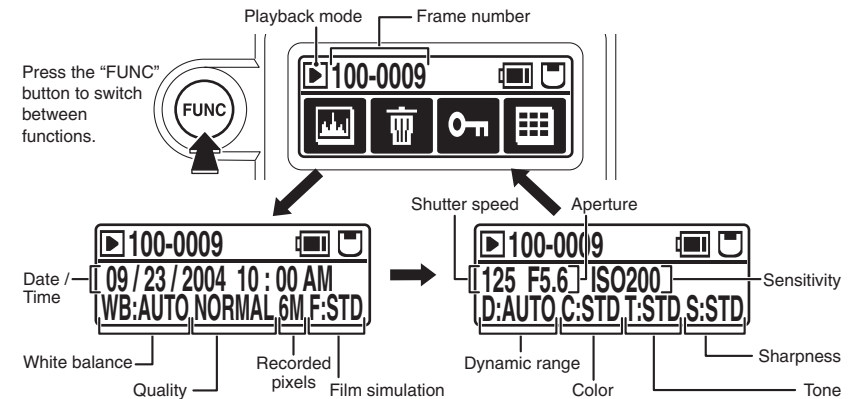

### Still images viewable on the FinePix S3 Pro

This camera will display still images recorded on the FinePix S3 Pro or still images (excluding some uncompressed images) recorded on any FUJIFILM digital camera that supports xD-Picture Cards or CF/Microdrives.

Clear playback or playback zooming may not be possible for still images shot on cameras other than the FinePix S3 Pro.

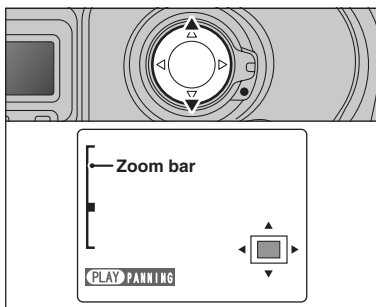

### Playback zoom

Press the “▲” or “▼” during single-frame playback to zoom (enlarge) the still image. A zoom bar appears.

Press the “BACK” button to return to single-frame playback.

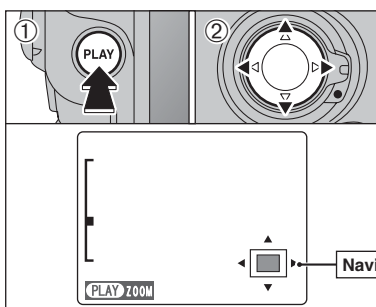

- ① Press “PLAY” button to select to “PANNING”.
- ② Press “▲”, “▼”, “◀”, or “▶” to display another area.

The current displayed image appears on the navigation screen.

Press the “PLAY” button to return to playback zoom.

### Zoom scales

Quality mode	Max. zoom scale
(4256 × 2848 pixels)	Approx. 26.6×
(3024 × 2016 pixels)	Approx. 18.9×
(2304 × 1536 pixels)	Approx. 14.4×
(1440 × 960 pixels)	Approx. 9.0×

Pages 45 to 49 provide explanations of how to use and set the camera's focusing functions, along with various related topics. The diagram below is a page map to this section. Refer to the pages indicated for details.

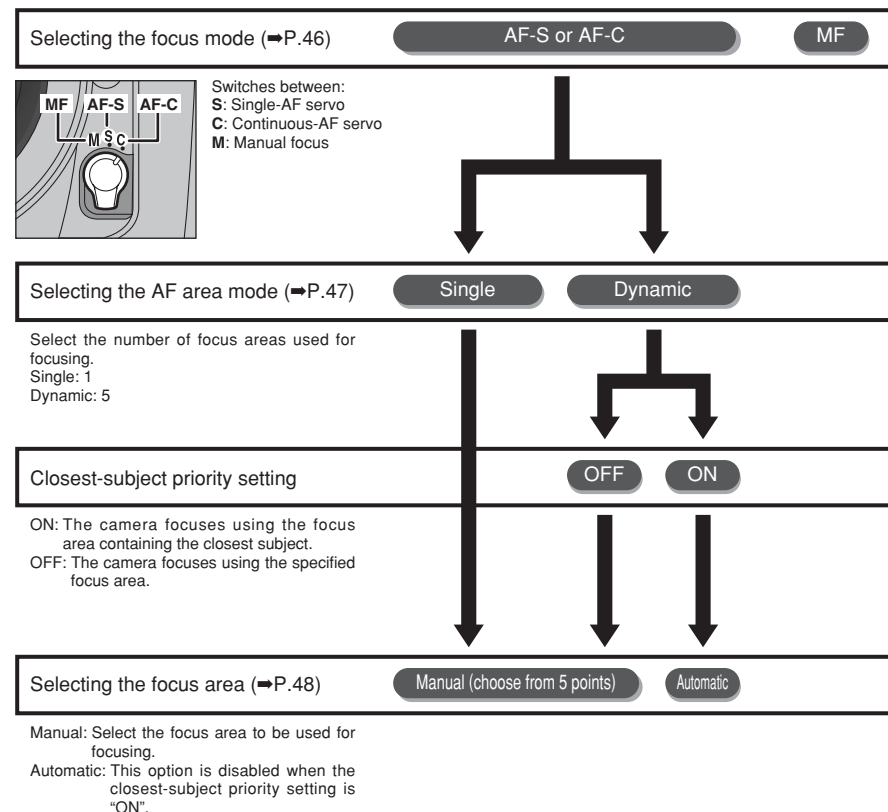

### Focus-related custom settings

<b>CSM 3:</b> Illumination for focus area	Sets the automatic illumination setting for the focus area in the viewfinder	⇒ P.111
<b>CSM 4:</b> Focus area selection	Sets the focus area selection method	⇒ P.111
<b>CSM 7:</b> Closest-subject priority dynamic AF at S-AF mode	Closest-subject priority dynamic AF settings	⇒ P.111
<b>CSM 8:</b> Closest-subject priority dynamic AF at C-AF mode	Sets the closest-subject priority dynamic AF settings	⇒ P.111
<b>CSM 9:</b> AE-L/AF-L button	Selects AE/AF concurrent locking, independent locking, or maintained locking	⇒ P.111

## FOCUS SETTINGS SELECTING THE FOCUS MODE

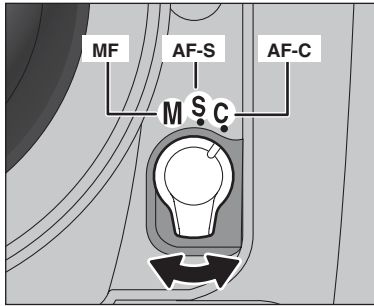

Use the focus mode selector switch to select the focus mode.

### Focus modes

	AF-S (S: Single-AF servo)	AF-C (C: Continuous-AF servo)	MF (M: Manual focus)
Features	Focus priority mode. The shutter will only release if the focus indicator "●" is displayed. (Excludes predictive motion focusing)	Release priority mode. The shutter will release even if the focus indicator "●" is not displayed.	Allows you to release the shutter at any time.
AF starts	When the shutter button is pressed down halfway (default).	When the shutter button is pressed down halfway (default).	AF is not used.
Focus lock	When the shutter button is held down halfway and the focus indicator "●" is displayed, the focus is locked.	Even when the shutter button is held down halfway and the focus indicator "●" is displayed, the focus is not locked and focusing continues. Press the AE-L/AF-L button to lock the focus.	The focus is not locked.
Predictive motion focusing (focus tracking function for moving subjects)	Only works for moving subjects from the time AF operation starts. While this function is operating, the camera decides when the subject is in focus and releases the shutter.	Also works for subjects that start moving during shooting.	Does not operate.

CSM 9: AF operation can be modified so that it does not begin when the shutter button is pressed down halfway, but when the "AE-L/AF-L" button is pressed (⇒P.111).

## FOCUS SETTINGS SELECTING THE AF AREA MODE

You can change the focusing method used for automatic focusing (when the focus mode selector switch is set to "S" or "C").

Single-area AF	<ul style="list-style-type: none"> <li>Focuses using the selected focus area.</li> <li>Useful for situations where you want to focus accurately on a more or less stationary subject.</li> </ul>
Dynamic AF	<ul style="list-style-type: none"> <li>If the subject is outside the specified focus area, another focus area is used for focusing.</li> <li>Useful for shots where it is difficult to accurately keep the subject in a given focus area, such as when you are tracking a moving subject (particularly one that moves in unpredictable ways).</li> </ul>
Closest-subject Priority AF	<ul style="list-style-type: none"> <li>Focuses using the focus area containing the subject closest to the camera.</li> </ul>

\* If spot metering is used in Closest-subject Priority AF mode, metering is always performed for the focus area in the center of the shot.

\* When you are using a telephoto lens or the subject is dark, the closest focus area may not be selected.

CSM 7/8: The focus mode determines whether Closest-subject Priority AF is ON or OFF. The default settings are "ON" in "S" (Single-AF servo) mode and "OFF" in "C" (Continuous-AF servo) mode. You can change these settings using the custom settings (⇒P.111).

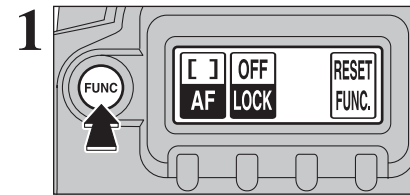

Press the "FUNC" button to display this screen.

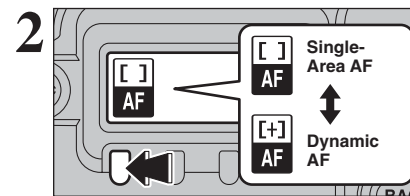

Select Single-area AF or Dynamic AF.

■ The displays shown in the viewfinder and on the top display panel are shown below.

	Single-area AF	Dynamic AF (Closest-subject Priority AF OFF)	Dynamic AF (Closest-subject Priority AF ON)
Focus area			
Top display panel/viewfinder display			

Then specify the focus area.

End of settings.



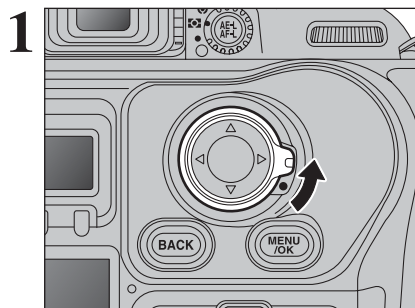

1 Unlock the 4-direction button.

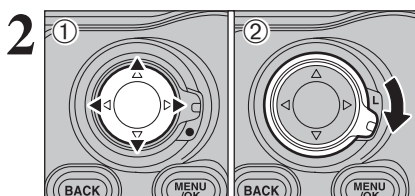

- ① Press “◀”, “▶”, “▲” or “▼” to select the focus area.
  - ② Once you have specified the focus area, lock the 4-direction button to prevent accidental improper use.
- The specified focus area is automatically illuminated in red according to the brightness of the subject.

**CSM 3:** The specified focus area is automatically illuminated, but you can change the settings so that the illumination is disabled or is no longer dependent on the subject brightness (➡P.111).

**CSM 4:** Normally, you can only select a focus area by pressing the arrow on the 4-direction button that points towards that focus area. However, you can set camera operation so that when the right-hand focus area is selected, pressing “▶” on the 4-direction button selects the left-hand focus area. This means you can switch between focus areas on opposite sides without having to press different sides of the 4-direction button (➡P.111).

Use Manual focus in situations where autofocus may not work as expected (➡P.39) or a lens other than an AF Nikkor lens (➡P.20) is attached.

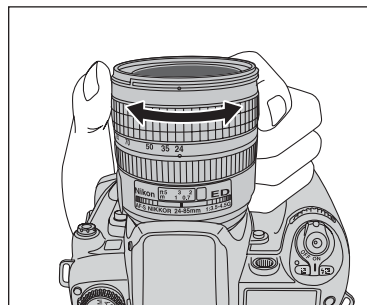

Focus the camera by turning the focusing ring on the lens until the image can be seen clearly in the matt surface of the viewfinder screen.

- When using a lens with the A-M select function, set the switch/ring to “M” to focus manually. If “M/A” (autofocus with manual priority) is available with your lens, Manual focus is possible either with the switch/ring set to “M” or “M/A”. See the instruction manual of your lens for details.

**Focus aid**

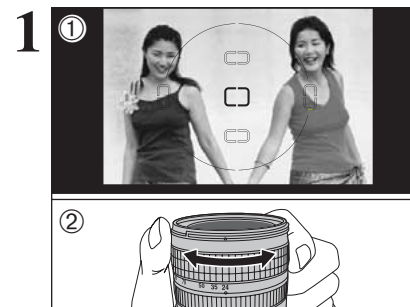

This allows you to check the focus of your shot using the focus indicator “●” in the viewfinder. You can use Focus Aid when the lens mounted has an f-stop setting brighter than f/5.6.

- ① Position the selected focus area over the object on which you want to focus.
- ② Turn the focusing ring on the lens.



Press the shutter button down halfway. When the shot is in focus, the focus indicator “●” lights.

◆ **Focus indicator** ◆

To make focusing easier on this camera, the range in which the focus indicator “●” lights is set to a fixed size. As a result, the camera does not react to slight movements of the focusing ring, thereby avoiding flickering in the focus indicator “●”. However, this means that the focusing position at the wide-angle setting is very slightly different from the focusing position at the telephoto setting, so that the shot may not be optimally focused even when the focus indicator “●” is lit. In this situation, you can focus precisely by positioning the focusing ring in the middle of the range in which the focus indicator “●” lights.



The release mode is normally set to Single-frame. Set the release mode to Continuous Shooting to take sequential shots of moving subjects or to take a series of shots using Auto Exposure Bracketting.

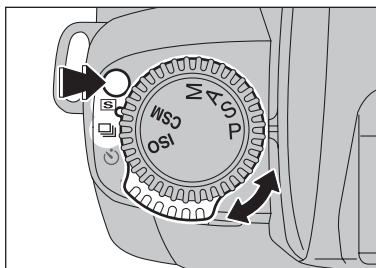

Hold down the release mode switch unlock button and set the release mode switch to “” (Single-frame) or “” (Continuous Shooting).

**S SINGLE-FRAME**

In this mode, one shot is taken each time you press the shutter button. Use this mode to take a single clearly defined shot in each frame.

- If you take a number of single-frame shots in rapid succession, the number of available shots is highlighted in the same way as in continuous shooting. Once this happens, no further shots can be taken. Wait until the number of available shots is no longer highlighted.

**C CONTINUOUS SHOOTING**

This mode allows you to take up to 12 consecutive shots by holding down the shutter button (Max. 2.5 frames/sec.).

- Once you have shot the maximum number of continuous frames, the number of available shots shown on the rear display panel is highlighted. No further continuous shots can be taken at that point. Wait until the number of available shots is no longer highlighted.



- You cannot use continuous shooting with the built-in flash.
- If “ON” or “PREVIEW” is selected for “IMAGE DISP.” (→P.103) when continuous shooting is used, only the photographed image for the final frame is displayed and automatically recorded.
- If you use continuous shooting when the number of available shots is low, the number of available shots may temporarily change to 0.

The number of available frame and the maximum number of continuous frames varies depending on the dynamic range (D-RANGE) and quality settings in SET-UP.

D-RANGE setting in SET-UP	WIDE		STANDARD	
	HIGH RAW	FINE, NORMAL JPEG	HIGH RAW	FINE, NORMAL JPEG
Max. number of available frames	Max. 1.4 frames/sec.	Max. 1 frame/sec.	Max. 2.5 frames/sec.	
Max. continuous frames	3	6	7	12
Minimum shooting interval in multiple exposure shooting	Max. 1.4 frames/sec.		Max. 2.5 frames/sec.	
Max. no. of consecutive shots in multiple exposure shooting	3		7	



You can use the self-timer when you want to be in the photograph. Use a tripod or place the camera on a stable surface before using the self-timer.

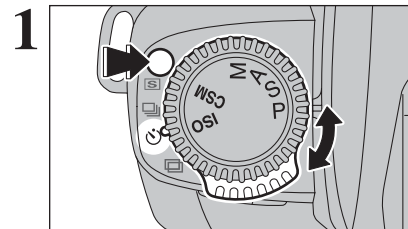

Hold down the release mode switch unlock button and set the release mode switch to “” self-timer.

**Before shooting**

- The self timer does not operate in situations where the camera shutter is disabled, such as when the focus is not set in AF-S (Single-AF Servo) mode.
- In exposure modes other than “M” (Manual), you must prevent any back-entry light from the eyepiece to obtain the correct exposure. Before pressing the shutter button, cover the eyepiece with your hand or the eyepiece cap provided. To attach the eyepiece cap, remove the rubber eyecup and slide the cap down over the eyepiece from above.
- Do not stand in front of the lens when setting the self-timer in autofocus mode.

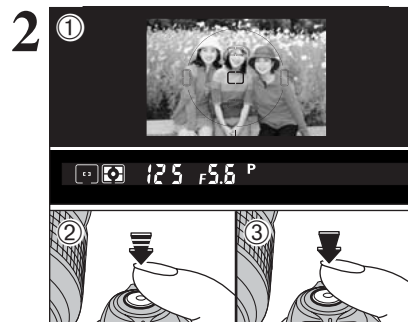

- Position the focus area over the subject.
- Press the shutter button down halfway to focus the shot.
- Without releasing the shutter button, press the shutter button down fully to start the self-timer.

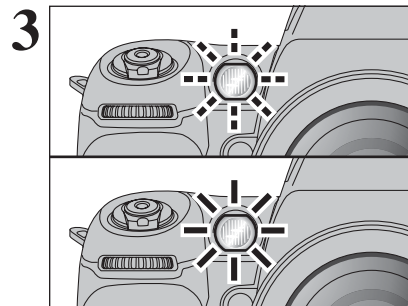

- The self-timer lamp flashes for 8 seconds and then stays lit for 2 seconds, after which the shot is taken.
- Press the “MENU/OK”, “FUNC” or “PLAY” button to cancel self-timer shooting.
  - You can change the self-timer running time from 10 seconds to 2, 5 or 20 seconds (→P.112).

This is a photography technique that allows you overlay photographed images on top of each other. You can use this technique to compose shots that cannot be obtained normally.

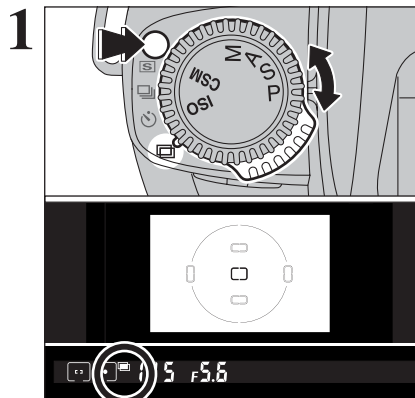

Hold down the release mode switch unlock button and set the release mode switch to "ME" (multiple exposure). When you select multiple exposure mode, the "ME" icon appears in the viewfinder display.

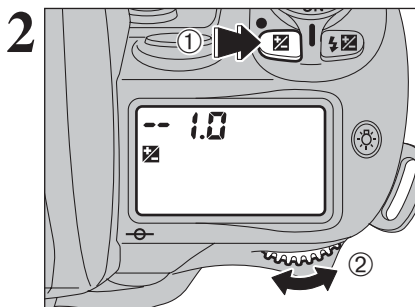

According to the photography conditions, hold down the "MC" (exposure compensation) button ① as you turn the Main-command dial ② to set the exposure offset.

#### ◆ Standard compensation value in Multiple exposure ◆

In multiple exposure, a number of images are shot in the same frame. When you are overlaying backgrounds and subjects, you must set the appropriate exposure offset before taking any shots.

#### ■ General guide to exposure offsets

Number of exposures	Compensation value
2	-- 1.0
3	-- 1.5
4	-- 2.0

- Test shooting is recommended since the compensation actually required varies depending on the shooting situation.
- When the background is completely dark and subjects do not overlap, no compensation is necessary for each shot.

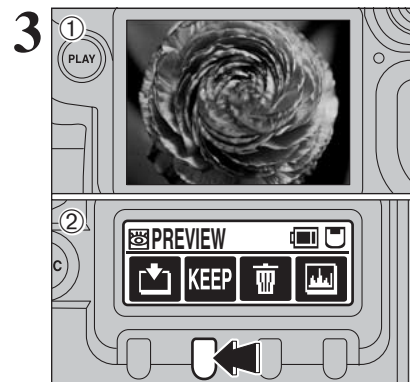

① When you compose, focus and take the shot, a preview image appears on the LCD monitor.

② Press the "F2" button to move on to the next shot.

- A preview image is always displayed, regardless of the "PREVIEW" setting selected in SET-UP.
- If you change the release mode before multiple exposure shooting is completed, no images are recorded.

The settings for multiple exposure shooting can only be changed from the function menu. At this point, the last settings specified apply.

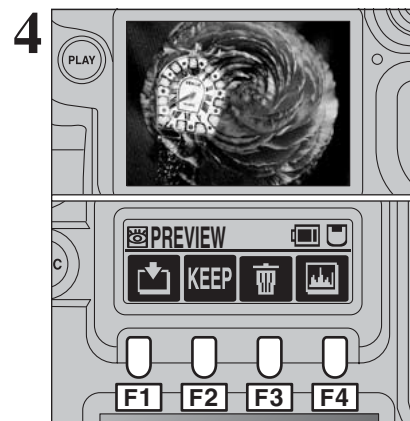

When you take the next (multiple exposure) shot, a preview appears showing the overlaid images.

- To record the image: Press the "F1" or "MENU/OK" button.
- To take another multiple exposure shot: Press the "F2" button.
- To take the shot again without using multiple exposure mode: Press the shutter button again.
- To cancel multiple exposure mode without recording the shots: Press the "F3" or "BACK" button.
- To check the brightness distribution: Press the "F4" button.

**CSM 11:** In multiple exposure mode, one shot is taken in the frame each time the shutter button is pressed, but continuous shooting can also be used (⇒P.111). Images in continuous shooting are overlapped in the preview display. Use the "F1", "F3" and "F4" buttons. "KEEP" cannot be selected in continuous shooting.

- ⚠ Multiple exposures cannot be used when only 1 frame is shot in continuous shooting.
- ⚠ You cannot use the built-in flash for continuous shutter release.
- ⚠ See P.50 for the max. no. of consecutive shots in multiple exposure shooting.

## METERING SYSTEMS

Normally, the Matrix metering system will provide the optimum exposure for your shot. However, you can choose from 3 metering modes for shots where you want to select a different exposure level (AE lock or exposure compensation) or for particular scenes (such as backlit shots or shots with very strong contrast).

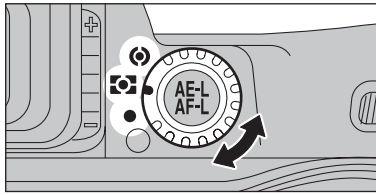

Turn the Metering system selector dial to desired metering system. The icon for the selected metering system appears in the viewfinder.

### Matrix (10-segment) metering

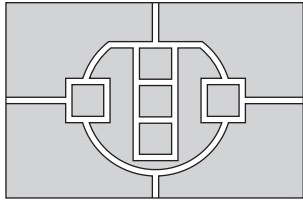

The camera sets the optimum exposure based on data (the maximum brightness and brightness contrast) measured independently for 10 segments in the photography screen.

With D- or G-type Nikkor lenses, 10-segment 3-D matrix metering is used, factoring in the distance to the subject as well as the maximum brightness and brightness contrast to ensure even more accurate metering.



### Center-weighted metering

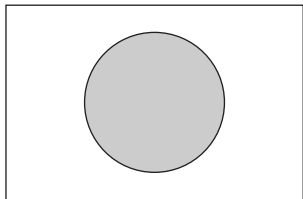

Center-weighted metering determines the exposure value based primarily on a 12-mm circle in the center of the viewfinder.



### Spot metering

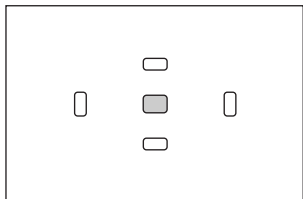

Spot metering determines the exposure value by concentrating metering on the equivalent of a 4-mm diameter area in the viewfinder (approx. 2% of the entire frame).

The metering area moves to follow shifts in the selected focus area. However, spot metering always remains in the center of the shot when Closest-subject Priority Dynamic AF mode is used.



## ISO SENSITIVITY

1

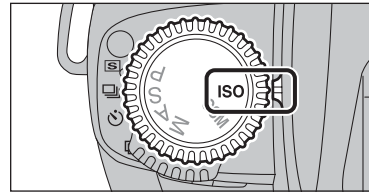

Set the Exposure mode dial to "ISO".

2

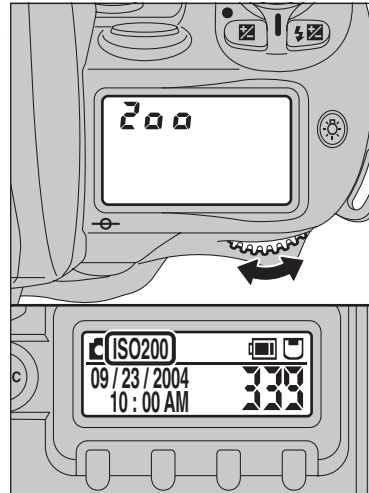

Turn the Main-command dial to set the ISO sensitivity.

- Available ISO sensitivity settings  
100, 160, 200 (factory default setting), 400, 800 and 1600

⚠ If you shoot dimly lit scenes with a low sensitivity setting and without using the flash, the color tones for the entire image may be incorrect.

Images shot in high-sensitivity photography (ISO 400 or higher) may appear coarse and may also be affected by noise such as white dots.

3

Advanced Photography

## EXPOSURE MODES **P** AUTO-MULTI PROGRAM

This mode automatically controls the shutter speed and aperture setting to give the optimum exposure for the photography conditions. This mode is useful when you want to be able to take pictures quickly and easily to take advantage of snapshot opportunities.

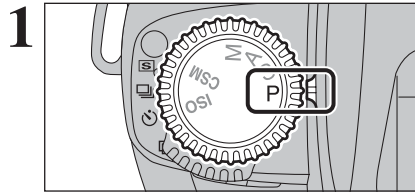

1 Set the Exposure mode dial to "P".

2 Compose picture, focus and shoot.

- When the subject is too dark or bright, one of the following warning indications will appear in the viewfinder or top display panel.
  - $\mathcal{H}$   $f$ : Use an ND filter.
  - $\mathcal{L}$   $\alpha$ : Use the flash.

### ◆ Flexible Program ◆

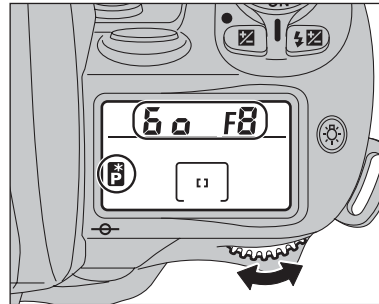
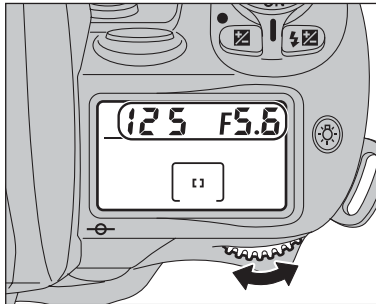

In Auto-Multi Program, by rotating the Main-command dial you can change the combination of shutter speed and aperture while maintaining correct exposure. With this function, you can shoot in Auto-Multi Program as though you were shooting in Shutter-Priority Auto or Aperture-Priority Auto. "B" appears in the top display panel when the Flexible Program is used. To cancel the Flexible Program, turn the Main-command dial until the Flexible Program icon "B" disappears, change the exposure mode, turn the Power switch to "OFF", use the built-in flash (⇒P.70), or perform a Two-Button Reset (⇒P.109).

## Program chart

The program chart shows exposure control in Auto-Multi Program mode (ISO 100).

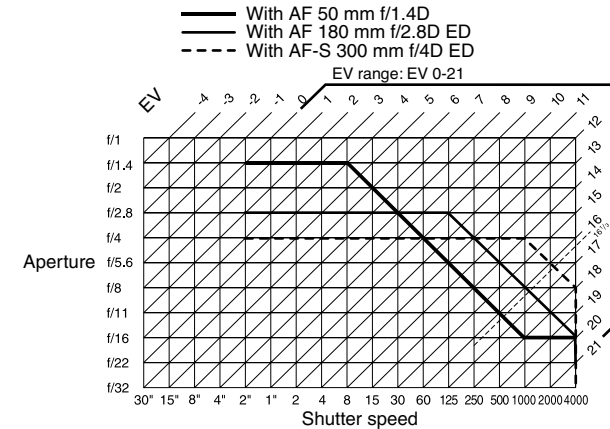

- Limits apply to the upper and lower EV values depending on the metering range for the ISO sensitivity setting.
- In Matrix metering, any EV above 16 1/3 is controlled to EV 16 1/3 when using ISO 100. Consequently, shots of very bright subjects may be overexposed.

If you select the "P", "S" or "A" exposure mode when you are not using a Nikkor lens with a built-in CPU, "F- -" appears on the top display panel and in the viewfinder and you cannot take pictures. When this occurs, you can take pictures by setting the exposure mode to "M" and using the aperture ring on the lens to set the aperture. Note that you cannot use the camera's exposure meter.

## EXPOSURE MODES **S** SHUTTER-PRIORITY AUTO

In this mode, the photographer sets the shutter speed (1/4000 sec. to 30 sec.) and the camera automatically controls the aperture setting. This mode is best when the shutter speed takes priority, such as shots where a fast shutter speed is used to freeze the action or a slow shutter speed is used to convey the sense of movement.

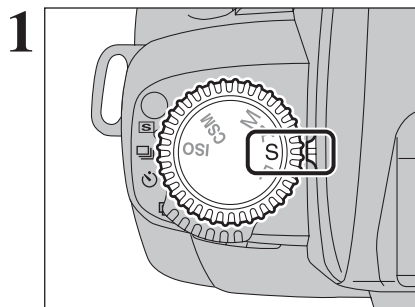

1 Set the Exposure mode dial to "S".

- If "bulb" is selected in "M" Manual exposure mode and the exposure mode is changed to "S" Shutter-Priority Auto without cancelling "bulb", "bulb" blinks and the shutter locks. When this occurs, select a shutter speed other than "bulb".

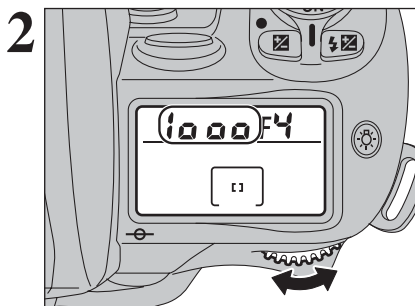

2 Set the shutter speed (1/4000 sec. to 30 sec.) on the Main-command dial.

Images shot with long exposures (4 second or longer) may appear coarse and may also be affected by noise such as white dots.

3 Compose picture, focus and shoot.

- When the subject is too dark or bright, one of the following warning indications will appear in the top display panel or viewfinder (Electronic analog exposure display will also indicate the amount of under- or overexposure).
  - **H** **f**: Select higher shutter speed. If the warning indication still remains on, use an ND filter.
  - **L** **a**: Select a slower shutter speed. If the warning indication still remains on, use the flash.
- At slow shutter speeds (1/8 sec. or slower), the camera performs noise removal processing after the shutter closes. As a result, the access lamp may not light for several seconds, increasing the interval between shots.

If you select the "P", "S" or "A" exposure mode when you are not using a Nikkor lens with a built-in CPU, "F- -" appears on the top display panel and in the viewfinder and you cannot take pictures. When this occurs, you can take pictures by setting the exposure mode to "M" and using the aperture ring on the lens to set the aperture. Note that you cannot use the camera's exposure meter.

## EXPOSURE MODES **A** APERTURE-PRIORITY AUTO

In this mode, the photographer sets the aperture (minimum aperture to maximum aperture) and the camera automatically controls the shutter speed. This mode is best for photographs where the priority is on the depth of field (the area where objects are in focus), such as shots where both near and distant objects are in clear focus (minimum apertures) or where the background is out of focus (maximum apertures).

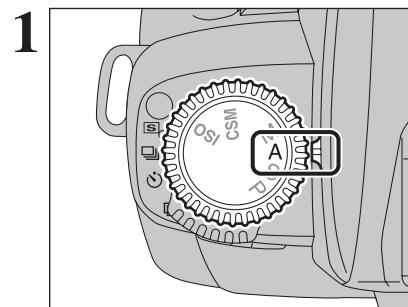

1 Set the Exposure mode dial to "A".

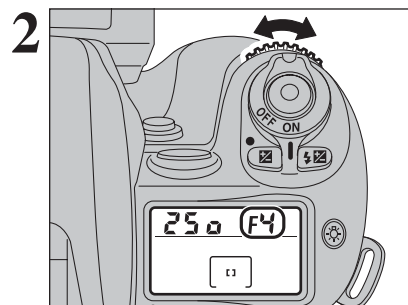

2 Use the Sub-command dial to set the aperture (minimum aperture to maximum aperture).

3 Compose picture, focus and shoot.

- When the subject is too dark or too bright, one of the following warning indications will appear in the top display panel or viewfinder (Electronic analog exposure display will also indicate the amount of under- or overexposure).
  - **H** **f**: Select smaller aperture (larger f-number). If the warning indication still remains on, use an ND filter.
  - **L** **a**: Select larger aperture (smaller f-number). If the warning indication still remains on, use the flash.

If you select the "P", "S" or "A" exposure mode when you are not using a Nikkor lens with a built-in CPU, "F- -" appears on the top display panel and in the viewfinder and you cannot take pictures. When this occurs, you can take pictures by setting the exposure mode to "M" and using the aperture ring on the lens to set the aperture. Note that you cannot use the camera's exposure meter.

In this mode, the photographer is free to set any shutter speed (1/4000 sec. to 30 sec. or “bulb”) or aperture setting (narrowest aperture to widest aperture). This allows the photographer to determine the exposure to suit the conditions and the desired effect while watching the electronic analog exposure display in the viewfinder.

**CSM 6:** To use the “bulb” shutter speed (for long exposures), the custom settings must be modified (⇒P.111).

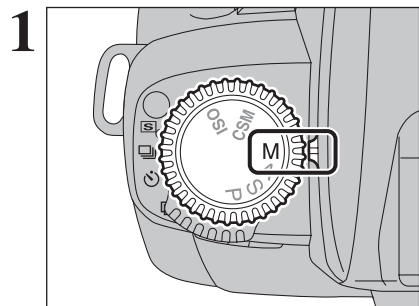

1 Set the Exposure mode dial to “M”.

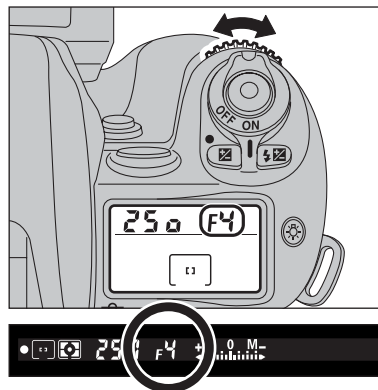
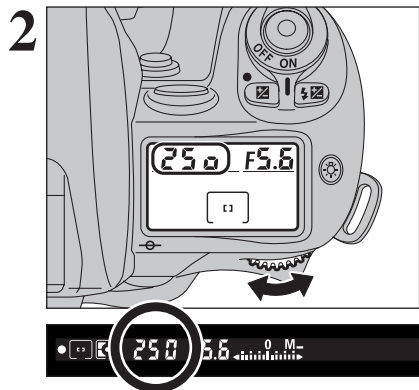

While watching the electronic analog exposure display in the viewfinder, use the Main-command dial to set the shutter speed (1/4000 sec. to 30 sec. or “bulb”) and the Sub-command dial to set the aperture setting (minimum aperture to maximum aperture).

- When the exposure compensation (⇒P.63) is set, only the electronic analog exposure display changes—selected shutter speed and aperture do not change.

Images shot with long exposures (4 second or longer) may appear coarse and may also be affected by noise such as white dots.

### ◆ Electronic analog exposure display ◆

The electronic analog exposure display in the viewfinder indicates the difference between the selected exposure (shutter speed and aperture) and the correct exposure. Not available with long time exposure. The electronic analog exposure display blinks when the subject brightness is beyond the camera's exposure range.

The following examples show electronic analog exposure display indications:

Correct exposure	-1/2 EV	Over +3 EV
+...0...-	+...0...-	+...0...-

### 3 Compose picture, focus and shoot.

If you are not using a Nikkor lens with a built-in CPU, you can take pictures by using the aperture ring on the lens to set the aperture. However, you cannot use the camera's exposure meter. “F-” also appears on the top display panel and in the viewfinder.

### Bulb photography (bulb)

Bulb photography is useful when you want to take pictures with any shutter speed. You should use a tripod to keep the camera steady because the shutter stays open for as long as the shutter button is held down.

Images shot with long exposures (4 second or longer) may appear coarse and may also be affected by noise such as white dots.

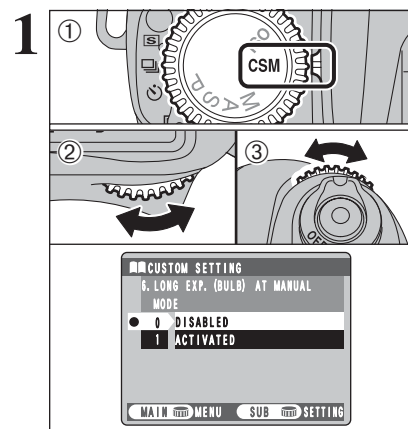

**CSM 6:** To use the “bulb” shutter speed (for long exposures), the custom settings must be modified (⇒P.111).

- ① Set the Exposure mode dial to “CSM”.
- ② Use the Main-command dial to select “6. LONG EXP. (BULB) AT MANUAL MODE”.
- ③ Use the Sub-command dial to select “1: ACTIVATED”.

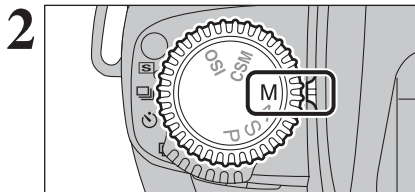

- Set the Exposure mode dial to "M".
- Bulb photography can only be used in Manual exposure mode.
  - A tripod should be used for bulb photography.

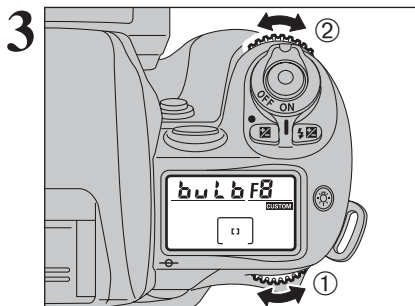

- ① Use the Main-command dial to set the shutter speed to "bulb" and then ② use the Sub-command dial to set the aperture setting (minimum aperture to maximum aperture).

- 4 Compose picture, focus and shoot.
- The shutter will be open as long as the shutter release button is kept fully depressed.
  - Using the cable release (sold separately) or remote release (sold separately) instead of holding the shutter release button down with your finger reduces camera shake.

◆ Remote Release Compatibility ◆

This camera can be used with 10-pin remote releases. Use the remote release (sold separately) with a tripod (sold separately) to prevent camera shake. Connect the remote release to the 10-pin terminal by matching the indicators on the terminal and accessory cord.

- Nikon accessories that can be used with the 10-pin terminal.
- Remote Cord MC-20
  - Remote Cord MC-30
  - Extension Cord MC-21
  - Luminosity Controller Set ML-3
  - Remote Cord MC-22
  - Conversion Cord MC-25

- ⚠ When not using the 10-pin terminal, always fit the terminal cap. Dust or soiling in the terminal can cause malfunctions.
- ⚠ If Auto Power Off has shut down the camera, the camera cannot be started up again from an accessory. (Use the custom settings to specify the delay until Auto Power Off shuts down the camera.)
- ⚠ The Connection Cord MC-23 is not supported.
- ⚠ If the camera loses power while you are using a cable release or directly holding down the shutter button, it cannot save the photographed image. If you are using a 10-pin remote-control cable, the image is saved at the point the batteries run out of charge.
- ⚠ Attach the bundled clamp filter when using the remote release (Secure the clamp filter by looping the cord through the filter at the connector end of the cord, as shown in the figure on the right).

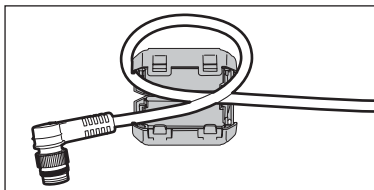

Exposure compensation allows you to intentionally vary the optimum exposure value controlled by the camera. This can be useful when intentionally achieving under- or overexposure. Use Center-weighted or Spot metering. Exposure compensation can be performed in any exposure mode (However in "M" exposure mode, only the electronic analog exposure display changes—selected shutter speed and aperture do not change).

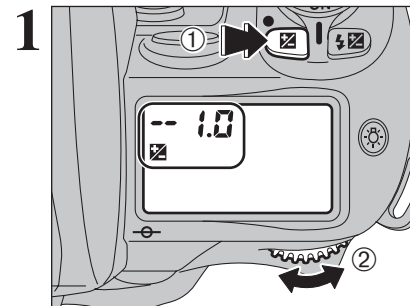

Set exposure compensation by rotating the Main-command dial while pressing the "☒" button until the desired compensation value appears (-3 EV to +3 EV in 1/2 EV steps).

- When the exposure compensation is set, "☒" appears on the top display panel and viewfinder. The Electronic analog exposure display also appears in the viewfinder. The compensation value can be checked by pressing the "☒" button.
- Electronic analog exposure display indicates the exposure compensation value and "0" blinks.
- Normally, you should compensate exposure to the + side when the background is brighter than your main subject, or to the - side when the background is darker.
- See P.73 for information on using flash exposure compensation to adjust the amount of light emitted by the flash.

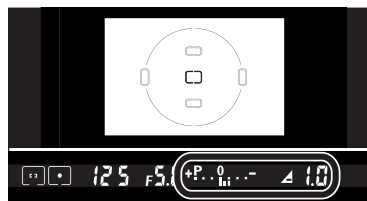

<Electronic analog exposure display>



-0.5 EV compensation



+2 EV compensation

- 2 Compose picture, focus and shoot.
- To cancel exposure compensation, set the compensation amount to "0.0" or perform a Two-Button Reset (⇒P.109) (Turning the camera off does not cancel exposure compensation).



## BKT AUTO EXPOSURE BRACKETING

Use auto exposure bracketing when you want to take the same shot with different exposure settings. Using the correct exposure setting displayed by the camera (the value set in “M” exposure mode) as a reference, the camera can automatically offset the exposure by a set value (up to  $\pm 2$  EV steps without exposure compensation) in either direction.

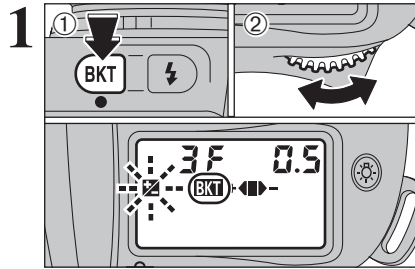

Hold down the “BKT” button ① as you turn Main-command dial ② to display the “BKT” icon on the top display panel.

- The “” icon continues to flash while auto exposure bracketing is being used to indicate that auto exposure bracketing photography is in progress.

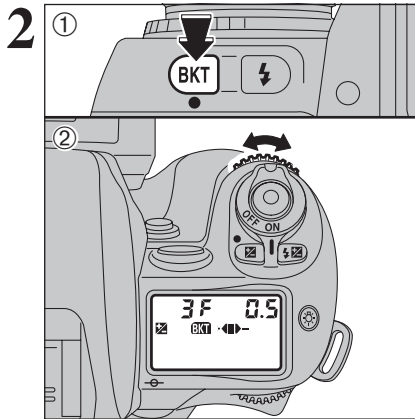

Hold down the “BKT” button ① as you turn Sub-command dial ② to set the number of shots (up to 3) and the exposure offset (up to  $\pm 2$  EV steps in 1/2 EV step increments).

- Check the number of available shots before setting the number of shot.

### ■ List of exposure offsets and numbers of shots

Number of shots and compensated EV value	Bracketing bar graph	Bracketing order
3F 0.5	+◀ ▶-	0, -0.5, +0.5
3F 1.0	+◀ ▶-	0, -1.0, +1.0
3F 1.5	+◀ ▶-	0, -1.5, +1.5
3F 2.0	+◀ ▶-	0, -2.0, +2.0
+2F 0.5	+◀	0, +0.5
+2F 1.0	+◀	0, +1.0
+2F 1.5	+◀	0, +1.5
+2F 2.0	+◀	0, +2.0
--2F 0.5	▶-	0, -0.5
--2F 1.0	▶-	0, -1.0
--2F 1.5	▶-	0, -1.5
--2F 2.0	▶-	0, -2.0

3 Compose picture, focus and shoot. A bracketing bar graph in the top display panel shows the photography status each time a shot is taken.

- When three shots are to be taken, “+◀|▶-” is shown before shooting begins, “+◀|▶-” appears after the first shot, “+◀|” appears after the second shot, and the bar graph disappears when shooting is completed.
- If you hold the shutter button down when the “” (Continuous shooting) release mode is selected, shooting automatically stops when the specified number of shots has been taken. Note that shots are taken one frame at a time when the built-in flash is used.
- If the exposure compensation function (⇒P.63) or flash exposure compensation (⇒P.73) is also set, Auto Exposure Bracketing will be combined with the exposure compensation values. It is useful to perform Auto Exposure Bracketing with a compensated value of over +2 EV or under -2 EV.
- To cancel the Auto Exposure Bracketing, rotate the Main-command dial while pressing the “BKT” button so “BKT” disappears from the top display panel or perform Two-Button Reset (⇒P.109). The number of shots and compensated EV values previously selected will remain when they are cancelled with the Main-command dial, and they automatically reset to “3F 0.5” when the Two-Button Reset is performed.

CSM 1: Bracketing order can be set to change from negative EV value to positive EV value (⇒P.111).

- The Auto Exposure Bracketing settings are canceled when the live image is displayed. Wait until live image display is finished before specifying the Auto Exposure Bracketing settings.

**SETTINGS FOR FLASH PHOTOGRAPHY**

Some flash settings can be set directly:

- Synchro mode (the flash timing and shutter speed)
- Flash exposure compensation (flash brightness adjustment)

Other settings are:

- Flash control mode (the system for measuring and adjusting the flash brightness)
- Flash control range (the effective range of the flash)

The basic settings for flash photography are explained on P.67 to P.73. If necessary, refer also to "NIKON FLASH UNITS THAT CAN BE USED" (→P.74).

◆ **How the flash control mode is set** ◆

The three flash modes are D-3D-Multi BL, D-Multi BL and Standard D-TTL. One of these is selected based on the exposure mode, the metering system and the lens-flash combination.

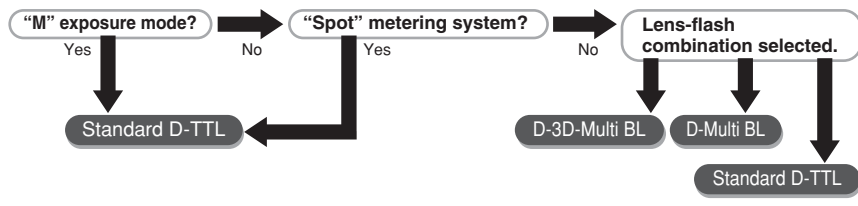

◆ **To increase the effective range of the flash** ◆

Item	Measure
Lens brightness	Use a brighter lens.
Guide No.	Use a higher number.
Aperture	Widen the aperture.
ISO setting	Increase the ISO setting.

The built-in flash for FinePix S3 Pro camera covers the field of view of a 20 mm lens. It has a guide number of 12 (ISO 100-m) and is controlled using the dedicated TTL mode (D-TTL mode) that controls the monitor brightness. D-3D Multi BL flash control and D-Multi BL flash control can be used to take natural-looking photographs with the flash. In addition to shooting in dim light, the flash can be used in daylight to reduce shadows on the main subject or to put catchlights in your subject's eyes. Five flash Synchro modes—Front Synchro (Normal Synchro), Slow Synchro, Rear Synchro, Red-Eye Reduction and Red-Eye Reduction with Slow Synchro—are available with FinePix S3 Pro camera.

■ **Flash control modes that can be used with the built-in flash**

Lens	TTL Auto Flash mode
D- or G-type Nikkor lens	D-3D Multi-Sensor Balanced Fill-Flash*1
CPU Nikkor lens other than D/G- type (except AF Nikkor for F3AF)	D-Multi-Sensor Balanced Fill-Flash*1
All Nikkor lenses	Standard D-TTL

\*1 When built-in flash is used and the exposure mode is set to Manual or Spot metering is selected, Standard D-TTL Auto Flash mode automatically changes to Standard D-TTL Flash.

**D-3D Multi-Sensor Balanced Fill-Flash**

D-3D Multi-Sensor Balanced Fill-Flash can be performed with a combination of the FinePix S3 Pro camera and D- or G-type Nikkor lens. Performs balanced (BL) metering that uses multi-pattern photometry information to provide a balance between the main subject of the shot and the background light.

When you press the shutter button, the camera flash fires a monitoring flash just before the shutter opens. The camera then instantaneously monitors the reflections from each part of the image using the sensors in its 5-zone TTL auto flash control. This information is then further enhanced using the information on the subject distance provided by the lens and the camera then determines the flash brightness that will perfectly balance the subject and the background light.

- If you set the metering mode to Spot or the exposure mode to "M", the built-in flash uses the Standard D-TTL flash control.

**D-Multi-Sensor Balanced Fill-Flash**

Multi-Sensor Balanced Fill-Flash, without the Distance Information added to the D-3D Multi-Sensor Balanced Fill-Flash, can be performed with a combination of the FinePix S3 Pro camera and CPU Nikkor lens other than D/G-type.

D-3D Multi-Sensor Balanced Fill-Flash together with D-Multi-Sensor Balanced Fill-Flash is called Automatic Balanced Fill-Flash with TTL Multi Sensor.

**Standard D-TTL Flash**

Can be used with any type of Nikkor lens. In Standard D-TTL Flash, automatic flash output level compensation is not available. This means that, even though the main subject is correctly exposed, the background may not be. Standard D-TTL Flash is useful when you want to highlight the main subject or perform flash exposure compensation.

## FLASH PHOTOGRAPHY SYNCHRO MODES AND THEIR FEATURES

You can select any of 5 modes to suit the type of shot and the desired effect.

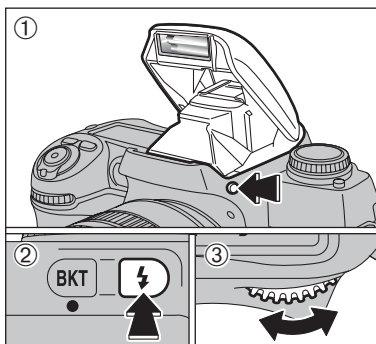

- Press the flash pop-up button to pop up the flash.
  - Hold down the "BKT" button.
  - Turn the Main-command dial to select the syncro mode.
- The icon shown on the top display panel changes as shown below.

When you are not using the flash, always keep it stowed away to prevent battery depletion.

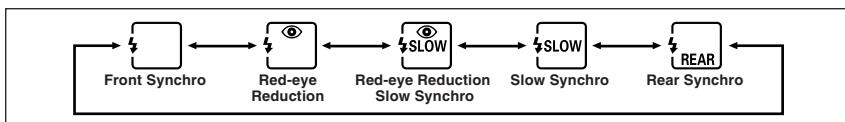

When some exposure mode and syncro mode combinations are selected, the syncro mode may be automatically changed subsequently.

Exposure mode	Synchro mode	Display during selection	Display after selection	Operation
P or A	Rear Synchro			Automatically set to Slow Synchro.
S or M	Red-eye Reduction Slow Synchro			Slow Synchro is cancelled (shutter speed not changed).
	Slow Synchro			



### FRONT SYNCHRO MODE

Can be used in all exposure modes. Select this mode for normal flash photography.



### SLOW SLOW SYNCHRO MODE

Can be used in the "P" and "A" exposure modes. Because this mode uses a slow shutter speed, it captures the background while at the same time firing the flash to produce a shot that captures the atmosphere of a twilight or nighttime scene.



### REAR REAR SYNCHRO MODE

Can be used in all exposure modes. In the "P" and "A" exposure modes, a slow shutter speed is used. The flash fires just before the shutter closes. This mode is effective in capturing the subject's movement as a flow of light in a way that looks natural.

Rear Synchro cannot be used with a studio flash system since the correct synchronization cannot be obtained.



### RED-EYE REDUCTION MODE

Can be used in all exposure modes. The red-eye reduction lamp lights for approx. 1 sec. before the flash fires in order to reduce the red-eye effect in photos of people or animals.

### SLOW RED-EYE REDUCTION SLOW SYNCHRO MODE

Can be used in the "P" and "A" exposure modes. This mode combines red-eye reduction with a slow shutter speed.

When a Nikon SB-80DX SB-28/28DX, SB-27 or SB-26 flash unit is used, the red-eye reduction lamp on the external flash fires.

Take care to ensure that the camera and the subjects (people) in the shot do not move until the shutter is released.

Depending on the type of lens mounted, the light from the red-eye reduction lamp may not reach the person, in which case the effect of the red-eye reduction lamp is lost.

## Shutter Speeds

The synchronized shutter speed is 1/180 sec.

The shutter speeds that can be set vary depending on the combination of syncro mode and exposure mode, as shown below.

Exposure mode Synchro mode	P or A	S	M
Front Synchro	1/180 to 1/60 sec. (automatically set by the camera*1)	1/180 to 30 sec.	1/180 to 30 sec. and <b>b u l b</b>
Slow Synchro	1/180 to 30 sec. (automatically set by the camera*2)	—	—
Rear Synchro	Automatically set to Slow Synchro. 1/180 to 30 sec. (automatically set by the camera*1 *2)	1/180 to 30 sec.	1/180 to 30 sec. and <b>b u l b</b>
Red-eye Reduction	1/180 to 1/60 sec. (automatically set by the camera)	1/180 to 30 sec.	1/180 to 30 sec. and <b>b u l b</b>
Red-eye Reduction Slow Synchro	1/180 to 30 sec. (automatically set by the camera*2)	—	—

\*1 When a Nikon SB-26, SB-25 or SB-24 flash unit is used, the syncro selector on the external flash unit sets the shutter speed.

\*2 Because a slow shutter speed is used, a tripod should be used to prevent camera shake.

## TAKING PICTURES USING THE BUILT-IN FLASH

Operation described in this section applies when the built-in flash and D- or G-type AF Nikkor are attached.

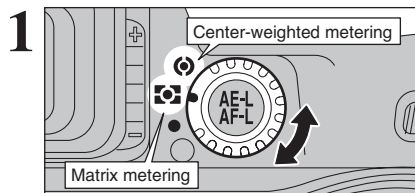

Set the metering system selector dial to "Matrix metering" or "Center-weighted metering".

⚡ If you select "•" (Spot Metering), the flash control mode is switched to "Standard D-TTL".

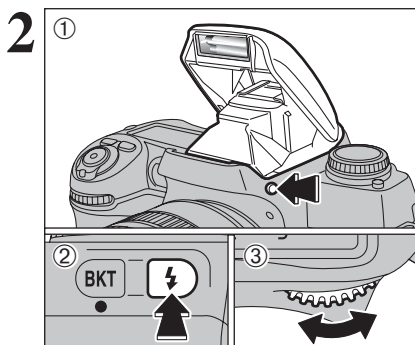

① Press the flash pop-up button to pop up the flash.  
② Hold down the "BKT" button.  
③ Turn the Main-command dial to select the synchro mode.

⚡ When you are not using the flash, always keep it stowed away to prevent battery depletion.

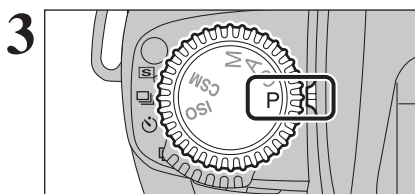

Set exposure mode and confirm shutter speed and aperture.

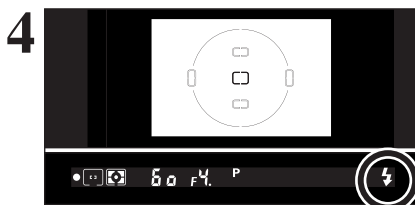

Check that the "4" (ready light) is displayed in the viewfinder.

⚡ If you take a number of continuous shots with the built-in flash, the "4" (ready light) may take a few moments to light.  
⚡ The shutter cannot be released unless "4" (ready light) appears without blinking in the viewfinder.

5 Bear in mind the composition, focus and effective flash range when taking pictures.

- ⚡ If the "4" (ready light) flashes for about 3 seconds after the shutter is released, this is a warning that the flash fired at full power and the shot may be underexposed. Play the image back to check it. If you decide to retake the shot, check the shooting distance, aperture, flash control range, etc. again before shooting.
- ⚡ If the subject is dark, the AF-assist illuminator fires to set the focus. See P.38 for details.
- ⚡ When you use the flash, shots are not taken continuously when the release mode is set to Continuous Shooting.
- ⚡ If the built-in flash is charging, camera-shake correction is not performed on a VR lens while the shutter button is pressed down halfway.

Exposure mode	Shutter speed	Aperture	Flash control mode
P	Synchronized shutter speed: 1/180 sec. See P.69 for details.	Automatically set by the camera	D-3D Multi BL
S		Any aperture	
A			
M			Standard D-TTL

\* Shutter speeds faster than the synchronized speed (1/180 sec.) cannot be set. When "180" appears in the viewfinder display and the specified shutter speed flashes on the display panel, the actual shutter speed is 1/180 sec.

\* The shooting distance is determined by the ISO setting and the aperture. For the "A" and "M" exposure modes, see the table below.

\* For the "P" exposure mode, the maximum aperture that can be set by the camera varies depending on the ISO setting. See P.75.

ISO setting	100	160	200	400	800	1600
Maximum aperture (built-in flash)	2.8	3.3	3.3	4	4.8	5.6

### Effective range of the built-in flash

The effective range of the built-in flash varies depending on the ISO sensitivity and aperture settings used. Refer to the table below.

Photography sensitivity (ISO) and aperture setting						Metering range
100	160	200	400	800	1600	
1.4	1.8	2	2.8	4	5.6	2-8.5 m (6.6-27.9 ft.)
2	2.5	2.8	4	5.6	8	1.4-6 m (4.6-19.7 ft.)
2.8	3.5	4	5.6	8	11	1-4.2 m (3.3-13.8 ft.)
4	5	5.6	8	11	16	0.7-3 m (2.3-9.8 ft.)
5.6	7.1	8	11	16	22	0.6-2.1 m (2.0-6.9 ft.)
8	10	11	16	22	32	0.6-1.5 m (2.0-4.9 ft.)
11	14	16	22	32	—	0.6-1.1 m (2.0-3.6 ft.)
16	20	22	32	—	—	0.6-0.8 m (2.0-2.6 ft.)

\* The minimum effective range for flash control using the built-in flash is 0.6 meters.

## LENSES THAT CAN BE USED WITH THE BUILT-IN FLASH

### ■ Usable lenses with built-in flash

- 20 mm to 300 mm CPU lenses can be used with the built-in flash.
- To prevent vignetting, remove the lens hood when using the flash.
- The built-in flash cannot be used at shooting distance less than 0.6 m (2.0 ft.).
- Zoom lenses with a macro feature cannot be used in the macro range.
- Vignetting occurs at the edges of the frame resulting in underexposure with the following zoom lenses, which have limitations in usable focal length or shooting distance:

Lens	Limitations
AF-S 17-35 mm f/2.8 ED	24 mm focal length at 0.8 m (2.6 ft.) or longer shooting distance
AF 20-35 mm f/2.8	20 mm focal length at 1 m (3.3 ft.) or longer shooting distance
AF 28-70 mm f/2.8 ED	28 mm focal length at 2 m (6.6 ft.) or longer shooting distance or 35 mm focal length at 0.7 m (2.3 ft.) or longer shooting distance

\* 20 mm to 200 mm non-CPU Nikkor lenses (AI-S, AI, AI-modified Nikkor) and Series-E lenses can be used with the built-in Flash. However following lenses have limitations in usable focal length or shooting distance:

Ai'd. 50-300mm f/4.5 (can be used at 200mm), Ai 50-300mm f/4.5 (can be used at 200mm), Ai'd. 85-250mm f/4 (can be used at 135mm and above), Ai ED 50-300mm f/4.5 (can be used at 135mm and above), Ai-S ED 50-300mm f/4.5 (can be used at 135mm and above)

### ■ Notes on using the built-in flash

- When the built-in flash is used, continuous shooting is not available even when the release mode is set to "C" (continuous shooting).
- If the built-in flash is charging, camera-shake correction is not performed on a VR lens while the shutter button is pressed down halfway.

## FLASH EXPOSURE COMPENSATION

Flash exposure compensation lets you intentionally change the correct exposure computed by the flash and the camera. For example, you can highlight the main subject by increasing the flash output or prevent the main subject from becoming too bright by decreasing the flash output.

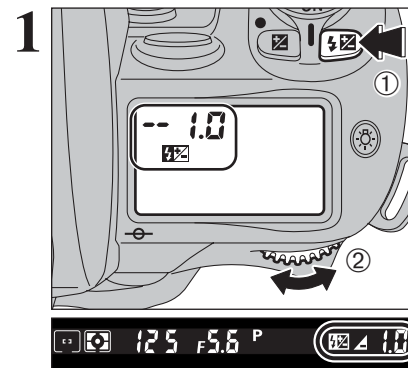

- ① Hold down the "Fn" button.
- ② Turn the Main-command dial to set the amount of compensation. The "Fn" icon appears on the top display panel and on the viewfinder.

Compensation range: -3 EV to +1 EV in 1/2 EV increments

Compensation guide: Select + settings when the background is brighter than the subject and - settings when background is darker.

- 2 The remainder of the procedure is the same as for normal flash photography (→P.70).

### To check the amount of compensation

Press the "Fn" button.

### ■ Sample flash exposure compensation displays

Compensation amount	Top display panel	Viewfinder display
"0.0"	0.0 Fn	Fn Fn 0.0
"+0.5"	+0.5 Fn	Fn ▽ 0.5
"-0.5"	--0.5 Fn	Fn ▲ 0.5

### To cancel exposure compensation

- Set the compensation amount back to "0.0".
- ⚡ Turning the camera off does not cancel flash exposure compensation.

## FLASH PHOTOGRAPHY NIKON FLASH UNITS THAT CAN BE USED

The Nikon flash models listed in the table below can be used with this camera. In the table, ① indicates D- or G-type Nikkor lenses (except IX-Nikkor), ② indicates CPU Nikkor lens other than D- or G-type (except AF Nikkor for F3AF) and ③ indicates non-CPU Nikkor lenses.

Flash	Lens	D-TTL			AA	A	M	☐	REAR	👁
		3D Multi-Sensor Balanced Fill-Flash	Multi-Sensor Balanced Fill-Flash	Standard TTL Flash	Aperture-linked automatic flash brightness control	Non-TTL Auto	Manual	Repeating Flash	Rear Synchro	Red-Eye Reduction
SB-28DX SB-80DX SB-800	①	✓*1		✓*2	✓		✓	✓	✓	✓
	②		✓*1	✓*2	✓		✓	✓	✓	✓
	③			✓		✓	✓	✓	✓	✓
SB-50DX	①	✓*1		✓*2			✓		✓	
	②		✓*1	✓*2			✓		✓	
	③			✓			✓		✓	
SB-600	①	✓*1		✓*2			✓		✓	✓
	②		✓*1	✓*2			✓		✓	✓
	③			✓			✓		✓	✓

With the Nikon flash units listed below, use external automatic flash control (A) or manual flash photography. Setting the mode to TTL locks the camera's shutter button so that no shots can be taken. In the table, ① indicates D- or G-type Nikkor lenses (except IX-Nikkor), ② indicates CPU Nikkor lens other than D- or G-type (except AF Nikkor for F3AF) and ③ indicates non-CPU Nikkor lenses.

Flash	Lens	A	M	☐	REAR	👁
		Non-TTL Auto	Manual	Repeating Flash	Rear Synchro	Red-Eye Reduction
SB-28 SB-26 *3	①	✓	✓	✓	✓	✓
	②	✓	✓	✓	✓	✓
	③	✓	✓	✓	✓	✓
SB-27 *4	①	✓	✓		✓	✓
	②	✓	✓		✓	✓
	③	✓	✓		✓	✓
SB-25 SB-24	①	✓	✓	✓	✓	
	②	✓	✓	✓	✓	
	③	✓	✓	✓	✓	
SB-23 *5 SB-29 *6, *5 SB-21B *6, *5 SB-29s *6, *5	①		✓		✓	
	②		✓		✓	
	③		✓		✓	
SB-30 SB-22s SB-22 SB-20 SB-16B SB-15	①	✓	✓		✓	
	②	✓	✓		✓	
	③	✓	✓		✓	
SB-11 *7 SB-14 *7	①	✓	✓		✓	
	②	✓	✓		✓	
	③	✓	✓		✓	

- ✓: Compatible
- \*1 Select metering system other than Spot.
- \*2 Set the photometering mode to spot metering.
- \*3 The SB-26 operates in slave mode. If the wireless slave selector is set to D, the camera's shutter is automatically switched to a slower speed than 1/180 sec.
- \*4 When used with the SB-27, the camera is automatically set to TTL mode. However, because the SB-27 cannot be used in TTL mode, reset the SB-27 to forced A mode.
- \*5 Not recommended as these are only for manual flash photography.
- \*6 When the SB-29s, SB-29 or SB-21B is used, autofocus shooting is only possible when an AF micro lens (60mm, 105mm, 200mm or 70-180mm) is mounted.
- \*7 To use AF mode or M mode with the SB-11 or SB-14, use the SU-2 on the SC-13 at the same time with the respective connections. The SB-11 and SB-14 can also be used connected to the SC-11 or SC-15, but in this configuration the ready light inside the camera's viewfinder cannot be used and the shutter speed is not automatically switched.

### Notes on using Nikon flash units

- Refer to the instructions supplied with the flash unit for details.
- If the instructions provided with a D-TTL-capable Nikon flash unit (sold separately) include a camera model chart, read the section on digital SLR cameras.
- The synchronized shutter speed when a flash is used is a slow speed of 1/180 sec. or slower.
- The operating range of shooting sensitivities in D-TTL mode is ISO 100-1600.
- With the SB-26, SB-25 and SB-24, the setting on the flash unit takes priority in Rear Synchro mode. (Note that this does not apply when "Red-eye reduction" or "Red-eye Reduction Slow Synchro" mode is selected on the camera.)
- If you set the camera's synchro mode to "Red-eye Reduction" or "Red-eye Reduction Slow Synchro" and then use a Nikon external flash unit that has its own red-eye reduction function, the red-eye reduction lamp on the external flash unit fires.
- Even when the optional flash with the AF-assist illuminator is attached, AF-assist illuminator does not emit light unless the conditions for AF-assist illumination are met.
- With SK-6 and SB-24 are attached, AF-assist illuminators of the camera body and the flash do not emit light.
- When the exposure mode is "P" Multi-Programmed Auto, the widest aperture that can be automatically set by the camera is governed by the ISO setting used, as shown in the table below.

ISO setting	100	160	200	400	800	1600
Maximum aperture (optional flash)	4	4.8	4.8	5.6	6.7	8

\* If an aperture that is wider than the controlled aperture is still too dark, the aperture is determined by widest aperture on the mounted lens.

- In D-TTL mode, if you use the TTL Sync Extension Cord SC-17 to operate the flash remotely from the camera, you may not obtain the correct exposure in D-TTL modes other than standard D-TTL flash control. If this happens, switch to standard D-TTL flash control. You should also take a test shot beforehand.
- Do not fit attachments (such as a diffuser panel) other than the built-in panel to the front of the flash in D-TTL mode. This causes errors in the camera's internal calculations and may result in the image being incorrectly exposed.
- TTL multi-flash photography is not possible in D-TTL mode.

### Flash attachments made by manufacturers other than Nikon

Use only Nikon flash models. Other units may damage the FinePix S3 Pro camera's electrical circuit due to incompatible voltage requirements (not compatible with 40V or higher), electric contact alignment or switch phase.

### Accessory shoe (with cover)

An optional flash, i.e. SB-80DX, 800, 600, 50DX, 27, 23, 22s or 29s can be attached directly to the accessory shoe of the FinePix S3 Pro camera without a cord. This accessory shoe is equipped with a safetylock which prevents accidental drop when a flash with a safety-lock pin (i.e. SB-80DX or 27) is attached.

Always install the accessory shoe cover when you are not using an external flash unit.

### Synchronizing terminal (with cap)

To use an external flash unit that requires a synchro cord, connect the synchro cord to the synchro cord terminal (with JIS-B locking screw).

Always fit the terminal cap when the sync terminal is not being used.

## USING THE FUNCTION MENU WHEN TAKING PICTURES

You can use the Function menu to change the quality settings (White Balance, Quality, Resolution, Film simulation, Dynamic range, Color, Tone, Sharpness) of saved images and the AF area settings.

**1** Turn the camera on and set the camera to Photography mode. If the Auto Power Off function has turned the camera off, press the shutter button down halfway to turn it back on.

**2** The functions change each time the "FUNC" button is pressed.

**3**

**Method 1**  
The setting changes each time you press the button.

**Method 2**  
The settings can be changed by holding down the button and pressing "▲" or "▼".

## WHITE BALANCE

### WHITE BALANCE

Change the settings when you want to set the white balance to suit the natural or artificial lighting conditions when you shoot.

When AUTO is selected, the correct white balance sometimes cannot be obtained under special light sources or for subjects where people's faces are highlighted, etc. In such cases, select the correct white balance setting for the light source.

● Factory default setting: AUTO

Display	Name	Description
	AUTO	The camera automatically determines the amount of light and the color information for the shot and takes the picture with a natural white balance.
	Custom 1	This setting uses the white balance setting specified by the photographer in the "SET-UP" menu (⇒P.104).
	Custom 2	
	Fine	Select this setting for outdoor shots in fine weather when the light source for the shot is the sun.
	Shade	Select this setting for shots taken in shade or on cloudy days.
	Fluorescent 1	Select this setting for shots taken under "Daylight" fluorescent lamps.
	Fluorescent 2	Select this setting for shots taken under "Warm White" fluorescent lamps.
	Fluorescent 3	Select this setting for shots taken under "Cool White" fluorescent lamps.
	Incandescent	Select this setting for shots when the light source is incandescent bulbs or lights.

● When the flash fires, the white balance setting (excluding custom white balance) for the flash is used. Consequently, to achieve a particular effect, the flash mode should be set to Suppressed flash.

## QUALITY / RECORDED PIXELS / FILM SIMULATION

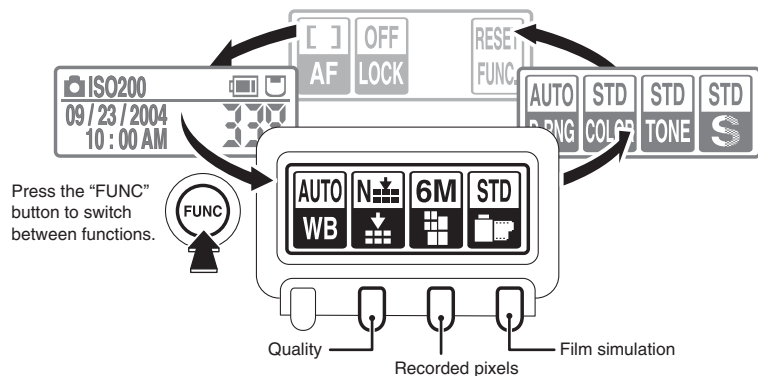

### QUALITY

Sets the quality of the photographed image. Select settings suited to the purposes for which the photograph will be used.

Select "FINE" for better quality or "HIGH" to shoot CCD-RAW images.

The "NORMAL" setting provides ample image quality for most purposes.

- Factory default setting: NORMAL

Display	Name	Description
	NORMAL	Allows you to record the largest number of images.
	FINE	Records images in high quality bettered only by the "High" setting. This mode allows you to record more images than the "High" setting.
	HIGH	CCD-RAW (⇒P.140): No image processing is performed on the camera. Select this setting when you want to process the image on a PC.

#### ◆ Shooting CCD-RAW images ◆

Because CCD-RAW images are not processed in the camera, the bundled software or the optional Hyper-Utility Software HS-V2 (⇒P.123) must be used to process the images on a PC.

- To shoot CCD-RAW images, set the quality to "HIGH". The image size setting automatically changes to "RAW" and cannot be changed.



When you display a CCD-RAW image, the frame number is highlighted.

### RECORDED PIXELS

Sets the size of the photographed image.

- Factory default setting: 3024 × 2016

Display	Name	Description
	1M	Sets the image size to 1440 × 960 pixels (approx. 1.38 megapixels). You can record the largest number of images in this mode.
	3M	Sets the image size to 2304 × 1536 pixels (approx. 3.54 megapixels).
	6M	Sets the image size to 3024 × 2016 pixels (approx. 6.10 megapixels).
	12M	Sets the image size to 4256 × 2848 pixels (approx. 12.10 megapixels). You can record the fewest images in this mode.

- You cannot set the image size when the quality is set to "HIGH".

Guide to printed image sizes

Name	Description
1M	Printing at up to 3R (8.9 × 12.7 cm/3.5 × 5 in.) size
3M	Printing at up to 6R (15.2 × 20.3 cm/6 × 8 in.) / A5 size
6M	Printing at up to 10R (25.4 × 30.5 cm/10 × 12 in.) / A4 size
12M	Printing at up to 35.6 × 43.2 cm (14 × 17 in.) / A3 size

### FILM SIMULATION

Sets the image formation parameters for photographed images.

- Factory default setting: STANDARD

Display	Name	Description
	STANDARD	This is the standard image composition mode and is ideal for a wide range of subjects, including portraits and scenery.
	FILM SIMULATION F1	This mode suppresses flaring in flash highlights when the flash is used and also stresses smooth tonal transitions in the reproduction of skin tones. It is ideal for studio portrait work where the aim is professional-standard negatives.
	FILM SIMULATION F2	This mode provides vibrant reproduction of natural colors such as blue skies and is ideal for landscape and nature photography.

- If you want to change this setting, select "sRGB" as the color space and "WIDE" as the "D-RANGE" (Dynamic range) setting in SET-UP.



# DYNAMIC RANGE / COLOR / TONE / SHARPNESS

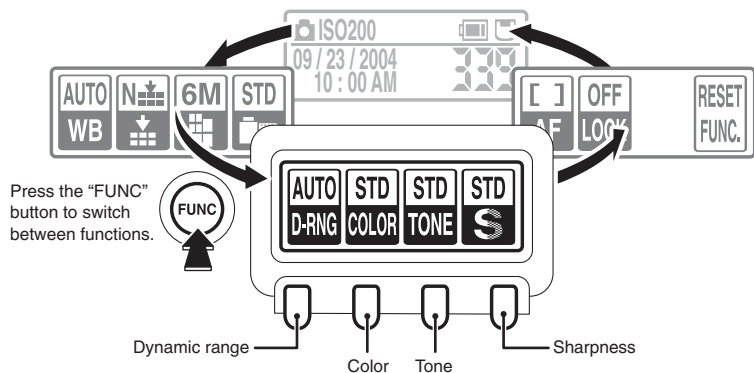

## DYNAMIC RANGE

Sets the dynamic range used for photographed images.

- Factory default setting: AUTO

Display	Name	Description
	AUTO	The camera automatically varies the dynamic range between 100% and 400% according to the scene being shot before taking the picture. This mode suppresses white flaring and black patches in scenes with high contrast while also enabling you to achieve good levels of contrast in pictures taken indoors or in cloudy weather where a wide dynamic range is not needed.
	WIDE 1	Takes the picture with the dynamic range set to 230% regardless of the scene being shot.
	WIDE 2	Takes the picture with the dynamic range set to 400% regardless of the scene being shot.

- If you want to change this setting, select "WIDE" as the "D-RANGE" (Dynamic range) setting in SET-UP.

## COLOR

Use the procedure below to set the density of the color used when images are shot.

- Factory default setting: STD

Display	Name	Description
	STD (STANDARD)	This setting sets the standard color density.
	HIGH	This setting provides a higher color density than the "STD" setting.
	ORG (ORIGINAL)	This setting specifies a lower color density than the "STD" setting. Use this setting for images that will undergo image processing for use in commercial printing.
	B/W	This setting converts the colors in the photographed image to black and white.

- If you want to view or print the image data directly, do not select "ORG".

## TONE

Use the procedure below to set the contrast when images are shot.

- Factory default setting: STD

Display	Name	Description
	STD (STANDARD)	This setting sets the contrast for photographed images to the standard level.
	HARD	This setting provides a higher level of contrast than the "STD" setting.
	ORG (ORIGINAL)	This setting specifies a lower contrast than the "STD" setting. Use this setting for images that will undergo image processing for use in commercial printing.

- If you want to view or print the image data directly, do not select "ORG".

## SHARPNESS

Use this setting to soften or sharpen the outlines in an image and to adjust the quality of the photographed image.

- Factory default setting: STD

Display	Name	Description
	STD (STANDARD)	This setting applies the optimum level of sharpness for normal shots.
	HARD	This setting sharpens the outlines in an image and is best for images of subjects such as buildings or text where clarity is important.
	OFF	Sharpness processing is not applied in this setting. Use this setting for images that will undergo image processing for use in commercial printing.

- If you want to view or print the image data directly, do not select "OFF".

### ◆ The dynamic range, color, tone and sharpness cannot be changed ◆



Selecting "F1" or "F2" as the film simulation setting (➔P.79) prevents these settings from being changed. Select "STD" as the film simulation setting.

# AF AREA / FUNCTION LOCK / FUNCTION RESET

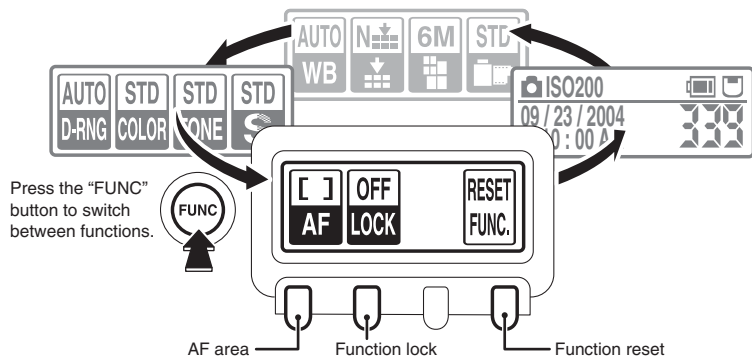

## AF AREA

Auto Focus provides two AF modes. In Single-area AF mode, the shot is focused using the selected focus area, while in Dynamic AF mode, multiple focus areas are used to set the focus. See P.47 for more detailed information on the AF area modes.

- Factory default setting: Single-area AF

Display	Name	Focus area	Viewfinder, Top panel display	Description
	Single-area AF			Useful for situations where you want to focus accurately on a more or less stationary subject.
	Dynamic AF	 or 	 or 	Useful for shots where it is difficult to accurately keep the subject in a given focus area, such as when you are tracking a moving subject (⇒P.47).

## FUNCTION LOCK

This feature allows you to lock the function menu settings so that they cannot be changed (to prevent accidental improper use).

- Factory default setting: OFF

Display	Name	Description
	OFF	Releases the function lock.
	ON	Sets the function lock. The settings cannot be changed once the function lock is applied. To change the settings, first press the "F2" button to cancel function lock.

## FUNCTION RESET

This resets the photography function menu options to their factory default settings.

- Press the "F4" button to display the reset confirmation screen.
- The following operations can be used in the reset confirmation screen:  
 To reset the menu: "**OK**" ("F1" button)  
 To return to the previous screen: "**NO**" ("F4" button)

# USING THE FUNCTION MENU

You can use this menu to work with a displayed image (histogram display, erase, protect) and switch between multi-frame and single-frame playback.

**1** Turn the camera on and press the "PLAY" button to select Playback mode. If the Auto Power Off function has turned the camera off, press the shutter button down halfway to turn it back on.

**2** The functions change each time the "FUNC" button is pressed.

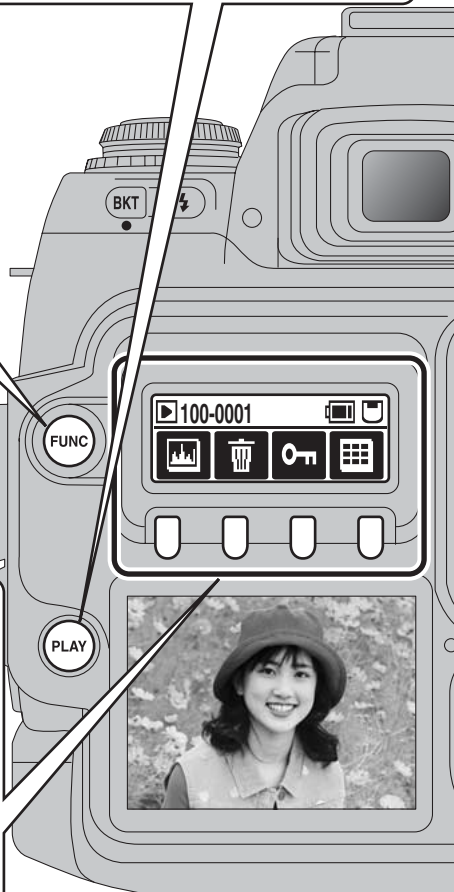
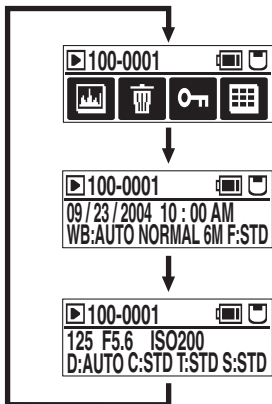

**3** **Histogram**  
The histogram display changes each time you press the button.

**Single-frame erase**

Erases an image.

**Protect frame**

Protects or unprotects an image.

**Multi-frame playback**

The mode switches between single-frame and multi-frame playback each time you press the button.

# HISTOGRAM

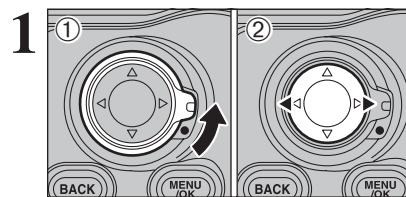

Unlock the 4-direction button ① and press "◀" or "▶" ② to select the frame for which the histogram is to be displayed.

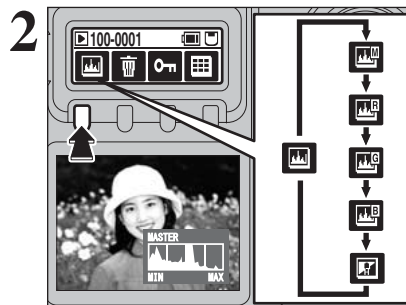

The histogram display changes each time you press the "F1" button. Histograms can be displayed for both playback images and preview images.

: Image histogram for brightness shown.

: Image histogram for red shown.

: Image histogram for green shown.

: Image histogram for blue shown.

: Uses blinking black to display areas of white flaring (Brightness warning).

**Brightness warning:** When the image is overexposed, areas where white blooming has occurred flash black.

⚠ The brightness warnings displayed during playback and during photographed image checking may differ.

⚠ If does not appear on the rear display panel, press the "FUNC" button to change the screen.

⚠ A histogram is a graph that shows the distribution of brightness in an image.

## About the histogram display

Icon	Mode	Even distribution	Sloping up to the right	Sloping up to the left
			MASTER brightness	<p>Shadows — Brightness — Highlights</p>
		Correct exposure	Overexposed	Underexposed

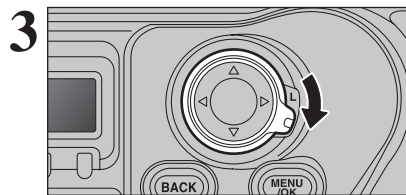

When you have finished the procedure, lock the 4-direction button to prevent accidental improper use.

PLAYBACK FUNCTION MENU **ERASING SINGLE-FRAME**

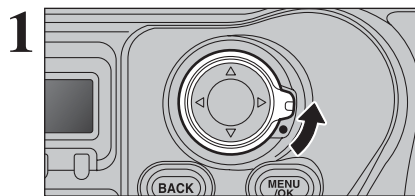

Unlock the 4-direction button.

Erased frames (files) cannot be recovered. Back up important frames (files) onto your computer or another media.

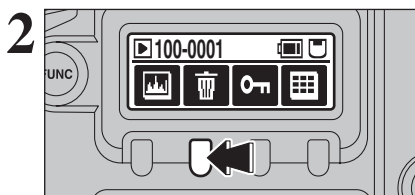

Press the "F2" button to display the erase confirmation screen.

- If "☒" does not appear on the rear display panel, press the "FUNC" button to change the screen.
- If the currently displayed frame is protected, "☒" appears instead of "☒" and the "☒" icon is displayed in the top-right corner of the LCD monitor.

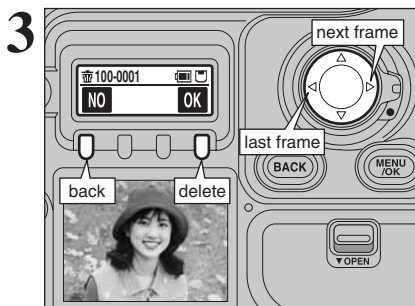

The following operations can be used in the erase confirmation screen:

- To select the frame: "◀" or "▶"
- To erase the displayed frame: "OK" ("F4" button)
- To return to the previous frame: "NO" ("F1" button) or "BACK" button

- "☒ PROTECTED FRAME" displayed for a frame indicates that the frame is protected. Unprotect the frame before erasing it.

If "DPOF SPECIFIED. ERASE OK?" appears, press the "OK" ("F4" button) to erase the frames (files).

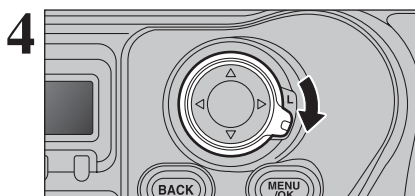

When you have finished the procedure, lock the 4-direction button to prevent accidental improper use.

PLAYBACK FUNCTION MENU **SINGLE-FRAME PROTECT**

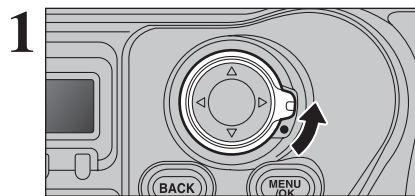

Unlock the 4-direction button.

Protection is a setting that prevents frames (files) from being accidentally erased. However, the "FORMAT" function erases all the frames (files), including protected frames (files) (→P.106).

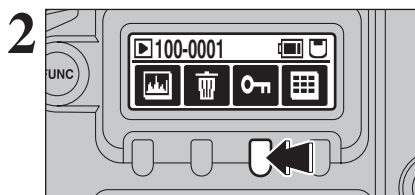

Press the "F3" button to display the protection screen.

- If "☒" does not appear on the rear display panel, press the "FUNC" button to change the screen.
- If the currently displayed frame is protected, "☒" is displayed instead of "☒".

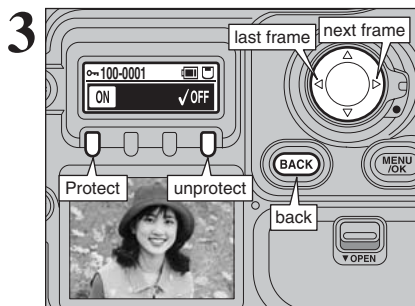

The following operations can be used in the protection screen:

- To select the frame: "◀" or "▶"
- To protect the frame: "ON" ("F1" button)
- To unprotect the frame: "OFF" ("F4" button)
- To return to the previous frame: "BACK" button

■ To check protected frames

	LCD monitor	Rear display panel (protection screen)	Rear display panel (during single-frame playback)
Protected	☒	100-0001 ☒ ON OFF	100-0001 ☒ ☒ ☒ ☒
Not protected	No icon	100-0001 ON ✓/OFF	100-0001 ☒ ☒ ☒ ☒

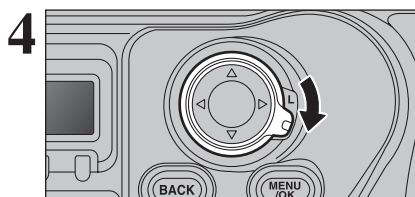

When you have finished the procedure, lock the 4-direction button to prevent accidental improper use.

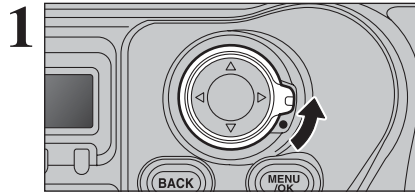

1 Unlock the 4-direction button.

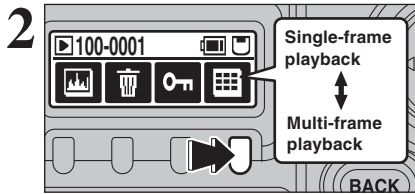

2 Press the "F4" button.

If "F4" does not appear on the rear display panel, press the "FUNC" button to change the screen.



3 Press "◀", "▶", "▲" or "▼" to move the cursor (the orange frame) and select a frame. Press "▲" or "▼" several times to move to the next or previous page.

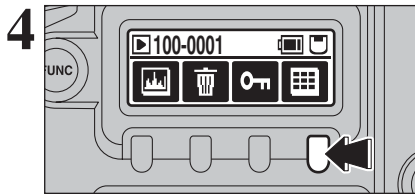

4 You can view the selected image enlarged by pressing the "F4" button again.

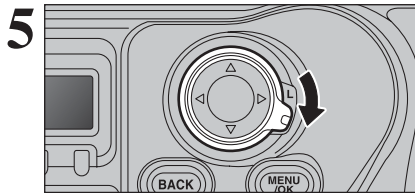

5 When you have finished the procedure, lock the 4-direction button to prevent accidental improper use.

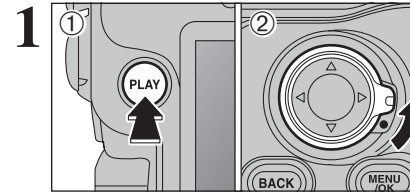

1 Press the "PLAY" button to select Playback mode.  
2 Unlock the 4-direction button.

Erased frames (files) cannot be recovered. Back up important frames (files) onto your computer or another media.

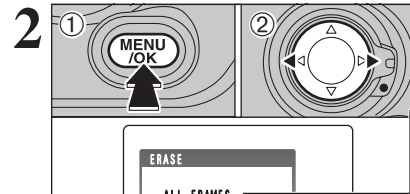

1 Press the "MENU/OK" button to display the menu screen.  
2 Press "◀" or "▶" to select "ERASE".

### ALL FRAMES

Erases all unprotected frames (files). Back up important frames (files) onto your computer or another media.

### BACK

Returns to playback without erasing any frames (files).

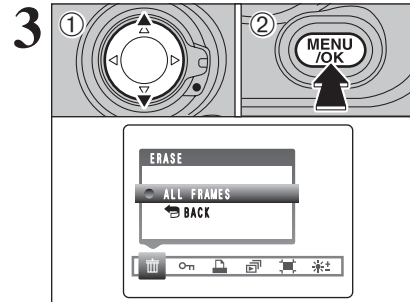

1 Press "▲" or "▼" to select "ALL FRAMES".  
2 Press the "MENU/OK" button.

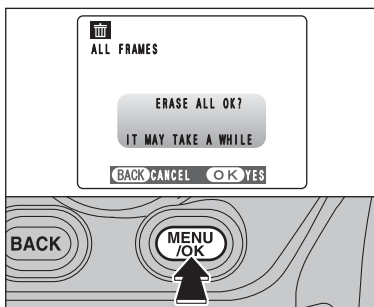

**ALL FRAMES**

Pressing the "MENU/OK" button erases all the frames (files).

Protected frames (files) cannot be erased. Unprotect the frames (files) before erasing them (⇒P.87).

If "DPOF SPECIFIED. ERASE OK?" or "DPOF SPECIFIED. ERASE ALL OK?" appears, press the "MENU/OK" button again to erase the frames (files).

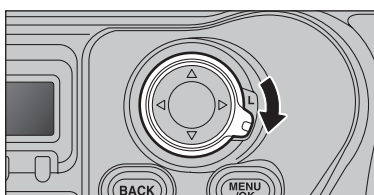

When you have finished the procedure, lock the 4-direction button to prevent accidental improper use.

◆ To stop the procedure midway ◆

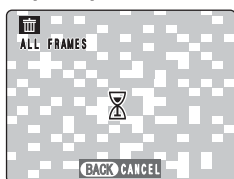

Press the "BACK" button to cancel erasing of all the frames (files). Some unprotected frames (files) will be left unerased.

Even if you stop the procedure immediately, some frames (files) will be erased.

PROTECTING IMAGES: SET ALL / RESET ALL

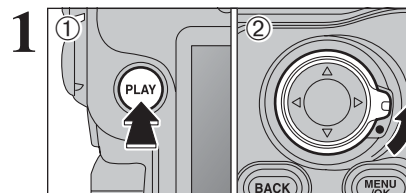

- 1 Press the "PLAY" button to select Playback mode.
- 2 Unlock the 4-direction button.

Protection is a setting that prevents frames (files) from being accidentally erased. However, the "FORMAT" function erases all the frames (files), including protected frames (files) (⇒P.106).

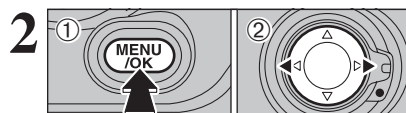

- 1 Press the "MENU/OK" button to display the menu on the screen.
- 2 Press "◀" or "▶" to select "On" PROTECT.

**RESET ALL**

Removes the protection from all the frames (files).

**SET ALL**

Protects all the frames (files).

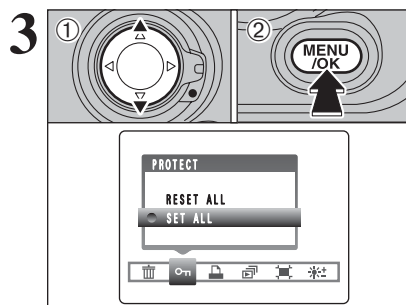

- 1 Press "▲" or "▼" to select "SET ALL" or "RESET ALL".
- 2 Press "MENU/OK" button to confirm your selection.

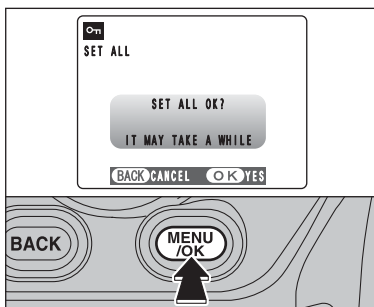

### SET ALL

Press the "MENU/OK" button to protect all the frames (files).

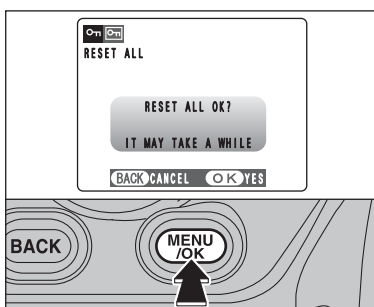

### RESET ALL

Press the "MENU/OK" button to unprotect all the frames (files).

4

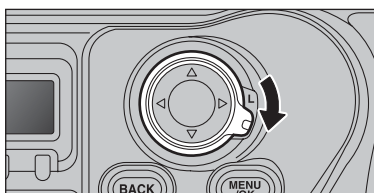

When you have finished the procedure, lock the 4-direction button to prevent accidental improper use.

### ◆ To stop the procedure midway ◆

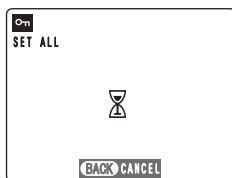

If the images are very large, protecting or unprotecting all the frames (files) may take some time.

If you want to take a picture during the procedure, press the "BACK" button. To then return to protecting or unprotecting all the frames (files), start the procedure on P.91 from step 1.



DPOF stands for Digital Print Order Format and refers to a format that is used for recording printing specifications for images shot using a digital camera on media such as an **xD-Picture Card** and CF/Microdrive. The recorded specifications include information on which frames are to be printed.

This section gives a detailed description of how to order your prints with the FinePix S3 Pro.

- \* Note that some printers do not support date and time imprinting or specification of the number of prints.
- \* Note that the warnings shown below may be displayed while you are specifying the prints.

**DPOF SPECIFIED. ERASE OK ?**

**DPOF SPECIFIED. ERASE ALL OK ?** (⇒P.86, 90)

When erasing the image, the DPOF setting for that image is deleted at the same time.

**RESET DPOF OK ?** (⇒P.94)

When inserting a media that contains images specified for printing on by another camera, those print specifications are all reset and replaced by the new print specifications.

**DPOF FILE ERROR** (⇒P.134)

Up to 999 images can be specified on the same media.

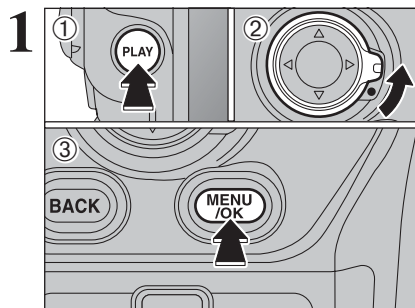

- ① Press the “PLAY” button to select Playback mode.
- ② Unlock the 4-direction button.
- ③ Press the “MENU/OK” button to display the menu screen.

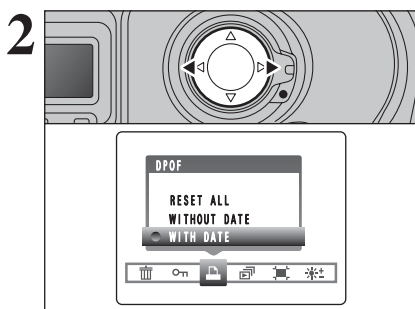

Press “◀” or “▶” to select “” DPOF.

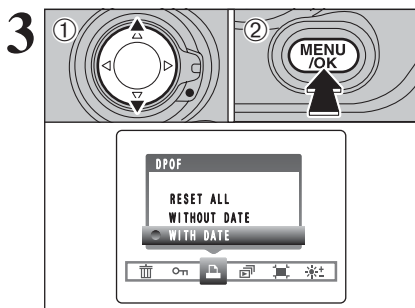
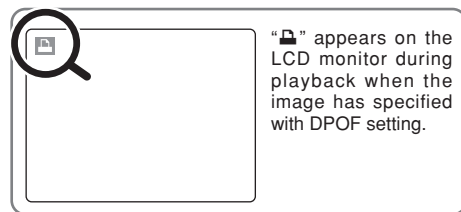

- ① Press “▲” or “▼” to select “WITH DATE” or “WITHOUT DATE”. Selecting “WITH DATE” will cause the date to be imprinted on your prints.
- ② Press the “MENU/OK” button.

 When selecting the “WITH DATE” setting, the date is imprinted on your shots using the Print Service or a DPOF-compatible printer (depending on the printer specifications, the date may not be printed in some cases).

◆ **When DPOF settings were specified on another camera** ◆



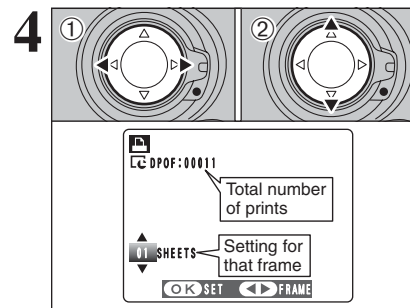

When the data includes a frame (file) with DPOF settings that were specified on another camera, “RESET DPOF OK?” appears. Pressing the “MENU/OK” button erases all of the DPOF settings already specified for each frame (file). Specify the DPOF setting for each frame (file) again.

 Press the “BACK” button to leave the previous settings unchanged.



- ① Press “◀” or “▶” to display the frame (file) for which you want to specify DPOF settings.
- ② Press “▲” or “▼” to set a value up to 99 as the number of copies of the frame (file) to be printed. For frames (files) that you do not want printed, set the number of prints to 0 (zero).

To specify more DPOF settings, repeat steps ① and ②.

-  Prints of up to 999 image frames (files) can be ordered on the same media .
-  DPOF settings cannot be specified for CCD-RAW.

Pressing the “BACK” button while choosing settings will cancel all current settings. If there were previous DPOF settings, only the modifications are cancelled.

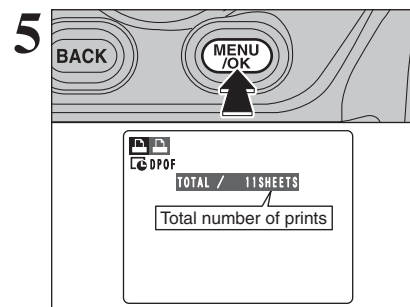

**Always press the “MENU/OK” button after the settings are completed.**

Pressing the “BACK” button cancels those settings.

◆ **Canceling a frame** ◆

To cancel the DPOF setting for a frame (file) you have specified (cancel frame), perform steps 1 to 3 and then:

- ① Press “◀” or “▶” to select the frame (file) with the DPOF setting you want to cancel.
- ② Set the number of prints to 0 (zero). To cancel the DPOF setting for another frame (file), repeat steps ① and ②. Press the “MENU/OK” button to complete the settings.

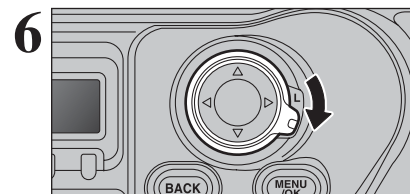

When you have finished the procedure, lock the 4-direction button to prevent accidental improper use.



PLAYBACK MENU  **DPOF (RESET ALL)**

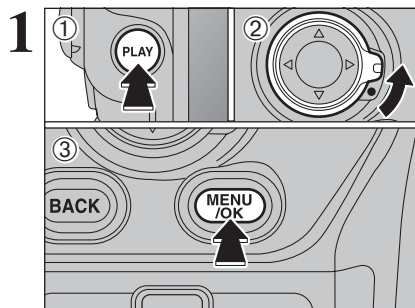

- ① Press the "PLAY" button to select Playback mode.
- ② Unlock the 4-direction button.
- ③ Press the "MENU/OK" button to display the menu screen.

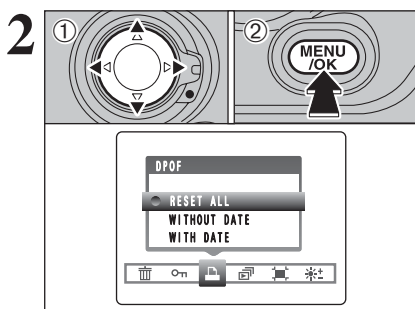

- ① Press "◀" or "▶" to select "DPOF". Press "▲" or "▼" to select "RESET ALL".
- ② Press the "MENU/OK" button.

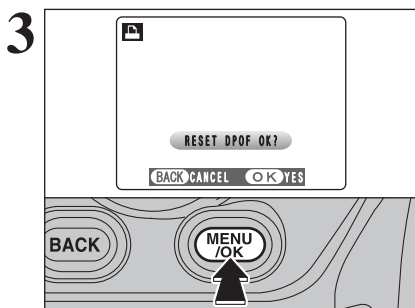

- A message appears. To reset all the DPOF settings, press the "MENU/OK" button.

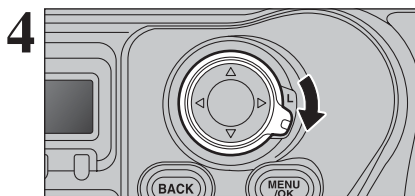

- When you have finished the procedure, lock the 4-direction button to prevent accidental improper use.

PLAYBACK MENU  **AUTOMATIC PLAYBACK**

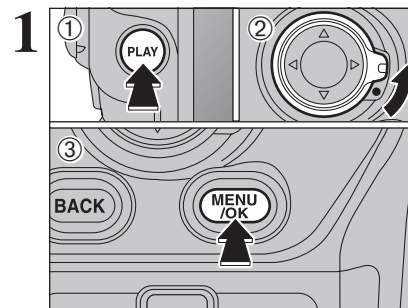

- ① Press the "PLAY" button to select Playback mode.
- ② Unlock the 4-direction button.
- ③ Press the "MENU/OK" button to display the menu screen.

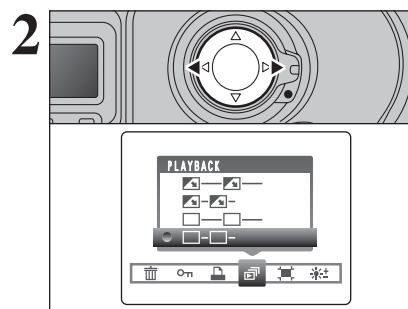

- Press "◀" or "▶" to select "PLAYBACK".

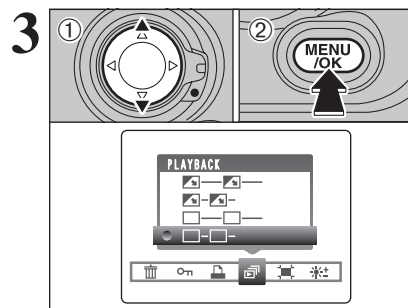

- ① Press "▲" or "▼" to select the playback interval and the type of image transition.
- ② Press the "MENU/OK" button. The image frames are advanced and played back. To interrupt PLAYBACK, press the "F1" button.

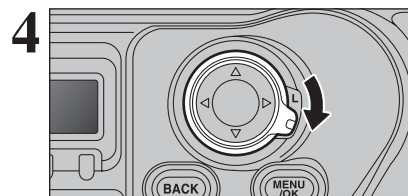

- When you have finished the procedure, lock the 4-direction button to prevent accidental improper use.

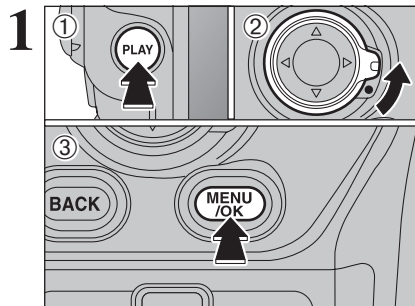

- ① Press the “PLAY” button to select Playback mode.
- ② Unlock the 4-direction button.
- ③ Press the “MENU/OK” button to display the menu screen.

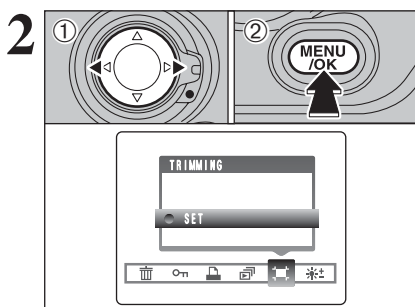

- ① Press “◀” or “▶” to select “” TRIMMING.
- ② Press the “MENU/OK” button.

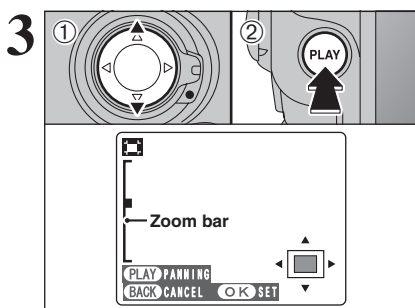

- ① Press “▲” to zoom in. Press “▼” to zoom out on a still image. A zoom bar appears on the LCD monitor.
- ② Press the “PLAY” button to move to another part of the image.

 Press the “BACK” button to return to single-frame playback.

Saved image size varies depending on the zoom scale. Up to 1M can be saved.

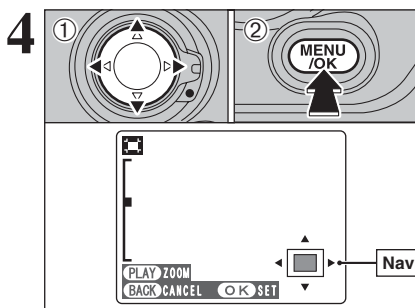

- ① Press “▲”, “▼”, “◀” or “▶” to display another area. The current displayed image appears on the navigation screen.
- ② Press the “MENU/OK” button to save the image.

 Press the “PLAY” button to return to zooming.

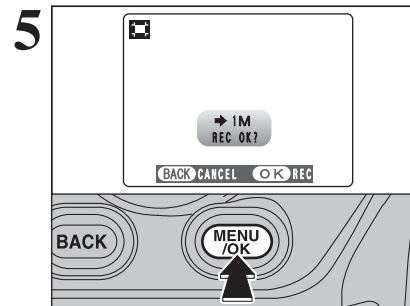

Check the saved image size and press the “MENU/OK” button. The trimmed image is added as a separate file in the final frame.

■ Image Sizes

6M	Printing at up to 10R (25.4 × 30.5 cm/10 × 12 in.) / A4 size
3M	Printing at up to 6R (15.2 × 20.3 cm/6 × 8 in.) / A5 size
1M	Printing at up to 3R (8.9 × 12.7 cm/3.5 × 5 in.) size

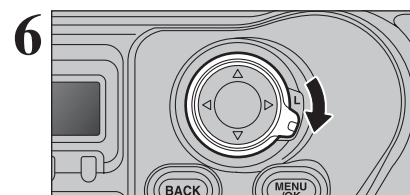

When you have finished the procedure, lock the 4-direction button to prevent accidental improper use.

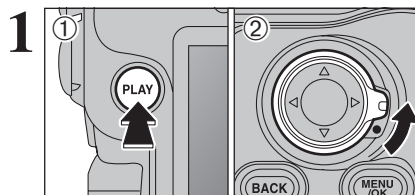

- 1 Press the "PLAY" button to select Playback mode.
- 2 Unlock the 4-direction button.

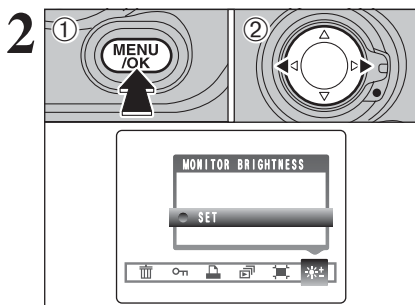

- 1 Press the "MENU/OK" button to display the menu screen.
- 2 Press "◀" or "▶" to select "⚡" MONITOR BRIGHTNESS.

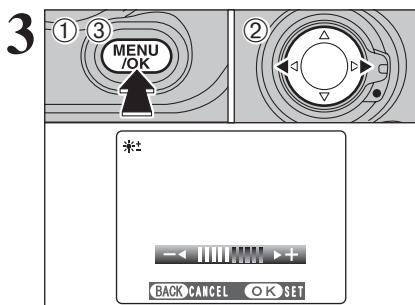

- 1 Pressing the "MENU/OK" button displays the monitor brightness setting screen.
- 2 Press "◀" or "▶" to adjust the monitor brightness.
- 3 Always press the "MENU/OK" button after the settings are completed.

When you have finished using the menu, lock the 4-direction button to prevent accidental use.

#### ◆ Brightness adjustment checking bar ◆

You can specify whether or not the brightness adjustment checking bar is displayed in the brightness setting screen.

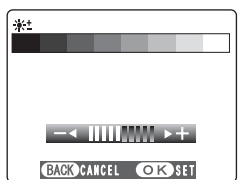
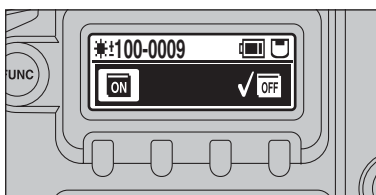

### USING THE SET-UP SCREEN

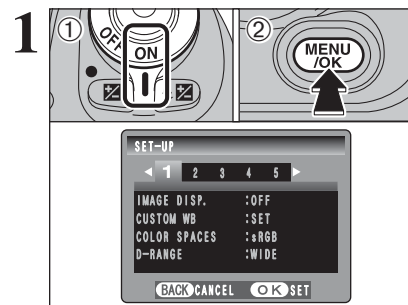

- 1 Turn the camera on and select Photography mode.
- 2 Press the "MENU/OK" button to display the SET-UP screen.

Always turn the camera off when replacing the batteries. Pulling out the battery holder or disconnecting the AC power adapter while the camera is still turned on may return the camera settings to the factory default values.

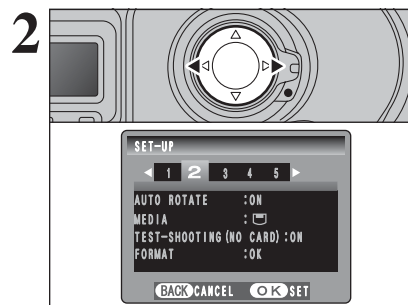

Press "◀" or "▶" to move to options 1 to 5.

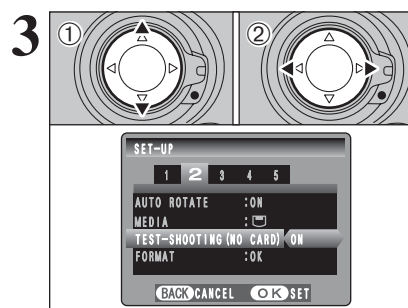

- 1 Press "▲" or "▼" to select a menu option.
- 2 Press "◀" or "▶" to change the setting. Press "▶" for "CUSTOM WB", "FORMAT", "DATE/TIME", "DISCHARGE", "RESET" or "LIVE IMAGE".

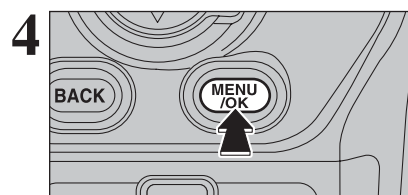

After you have changed the settings, press the "MENU/OK" button to confirm the changes.

When you have finished using the menu, lock the 4-direction button to prevent accidental use.

■ SET-UP menu options

Settings	Display	Factory default	Explanation	page	
IMAGE DISP.	OFF/ON/PREVIEW	OFF	Specifies whether the preview images (the photographed image) is displayed after taking a picture.	103	
1	CUSTOM WB	SET	Use this setting to specify an the correct white balance setting for a light source.	104	
	COLOR SPACES	sRGB/AdobeRGB	sRGB	Sets the color space to sRGB or Adobe RGB (1998).	105
	D-RANGE	WIDE/STANDARD	WIDE	Specifies whether the standard dynamic range (100%) or an extended dynamic range (400%) is used.	105
	AUTO ROTATE	ON/OFF	ON	Specifies whether the camera automatically detects shots taken in the vertical position.	106
2	MEDIA	(xD-Picture Card)  (CF/Microdrive)		Sets the media to be used when an xD-Picture Card and CF/Microdrive are loaded in the camera.	—
	TEST-SHOOTING (NO CARD)	ON/OFF	ON	Select "ON" in this setting to release the shutter even when no media is loaded in the camera. Note that no image is recorded (unless a media is loaded).	—
	FORMAT	OK	—	Erases all files.	106
	BEEP	LOW/HIGH/OFF	LOW	Sets the volume of the tone emitted when the camera controls are used.	—
DATE/TIME	SET	—	Corrects the date or time.	27	
3	USB MODE			: DSC (Mass storage device) mode This mode provides a simple way to read images from an a media and store images onto a media. The USB interface connection can be used for high-speed file transfer.	114
				: PictBridge If a printer that supports PictBridge is available, images can be printed by connecting the camera directly to the PictBridge-compatible printer without using a computer.	117
	1394 MODE			: DSC (Mass storage device) mode This mode provides a simple way to read images from an a media and store images onto a media. The IEEE 1394 interface connection can be used for high-speed file transfer.	114
				: 1394 Shooting Allows you to control the camera and take pictures from a PC. Also allows the photographed images to be automatically saved on the PC.	114
FRAME NO.	CONT./RENEW	CONT.	Specifies whether frame numbers are assigned consecutively from previous numbers or begin again.	106	
4	言語/LANG.	日本語/ENGLISH/ FRANCAIS/DEUTSCH/ ESPAÑOL/ITALIANO/中文	ENGLISH	Specifies the language used for LCD monitor display.	28
	VIDEO SYSTEM	NTSC/PAL	—	Specifies whether video output is set to NTSC or PAL.	—
	DISCHARGE	OK	—	Discharges Ni-MH batteries.	107
5	RESET	OK	—	Resets all the camera settings (other than the CUSTOM WB, FORMAT, DATE/TIME, LANG. and VIDEO SYSTEM, LIVE IMAGE) to the factory default values set at shipment. A confirmation message appears when you press "▶". To reset the camera settings, press the "MENU/OK" button again.	—
	LIVE IMAGE	ON	—	Displays the live image on the LCD monitor.	108

IMAGE DISPLAY

This setting allows you to specify whether the resulting image is displayed after you take a shot.

- OFF:** The photographed image is automatically recorded without being displayed.
- ON:** The photographed image is displayed for about 2 seconds and is then automatically recorded.
- PREVIEW:** The photographed image is displayed and then automatically recorded. Pressing the "F2" button (Erase) while the image is displayed deletes the recorded image. Pressing "F1" (End checking), "MENU/OK", "BACK" or the shutter button clears the display ready for the next shot.

Procedure when "PREVIEW" is set

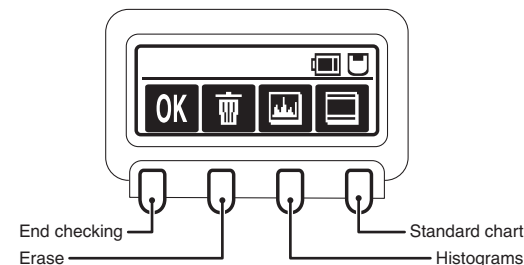

Preview zoom

Unlock the 4-direction button and press "▲" or "▼" to zoom in or out. To view another part of the image, press the "PLAY" button and then press "▲", "▼", "◀" or "▶" to move around. To return to zoom mode, press the "PLAY" button again.

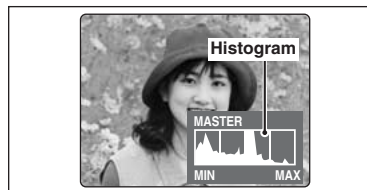

Histogram

Pressing this button displays the histogram. The display changes in a cycle from MASTER ⇒ R ⇒ G ⇒ B each time the button is pressed.

See P.85 for more information on histograms.

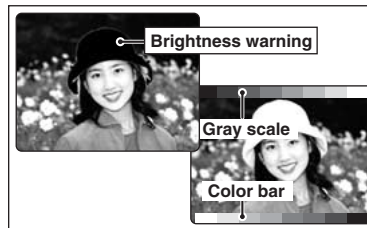

Brightness warning and standard chart

The display switches between the brightness warning indicator and the standard chart each time you press the button. Use these features to check the brightness and color tones in the image.

### SETTING THE CUSTOM WB

**1** Use this function to set the correct white balance for a light source. You can also use this function to achieve a desired special effect. Press the "F1" (custom WB 1) button or the "F4" (custom WB 2) button to select the custom white balance you want to set.

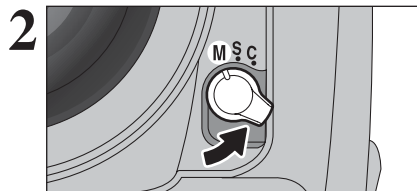
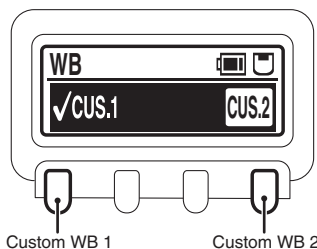

**2** Turn the focus mode selector switch to "M" (Manual focus) and set the focus manually.

⚠ The camera's auto focus function may be unable to focus on a subject such as a white sheet of paper, which will prevent the shutter from operating.

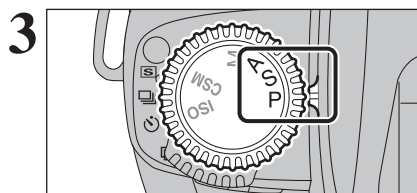

**3** Set the exposure mode to "P", "S" or "A".

⚠ While a custom white balance can also be measured in "M" mode, the image may be extremely overexposed or underexposed so that the optimum measurement is not taken.

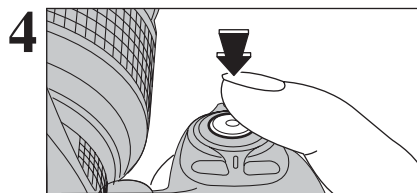

**4** Hold up a page of white paper or a similar object under the target light source so that the paper fills the viewfinder screen. Then press the shutter button to set the custom white balance.

● Range of custom WB settings  
Color temperatures from approx. 2800 K to 9500 K

#### ◆ Matching customized white balance using an external flash ◆

If you use an external flash with the exposure mode set to "M", you can make it easier to match the white balance to the photography settings (aperture, flash brightness, etc.) by using a commercially available 18% grey standard chart instead of white paper.

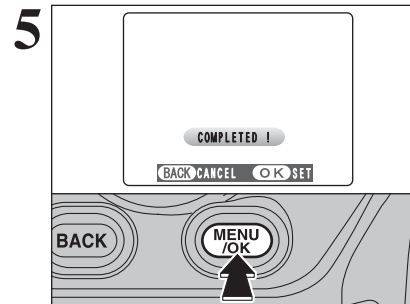

**5** If the exposure is measured correctly, "COMPLETED!" appears on the LCD monitor. Press the "MENU/OK" button to confirm the setting.

⚠ After taking the picture, check the color tones (white balance) in the image.  
● Select "PREVIEW" as the photographed image display option (⇒P.103) in the SET-UP screen.  
● Press the "PLAY" button (⇒P.43).  
When you have finished setting the white balance, select the focus mode you want to use.

### ■ When the exposure is not measured correctly

	Remedy
OVER	The subject is too bright. Use a negative (-) exposure compensation value and set the white balance again.
UNDER	The subject is too dark. Use a positive (+) exposure compensation value and set the white balance again.
OUT OF RANGE	Because the exposure is outside the range of valid custom white balance settings, the maximum (or minimum) value has been set. ● Available custom WB settings: Color temperatures of approx. 2800 K to 9500 K

### COLOR SPACES

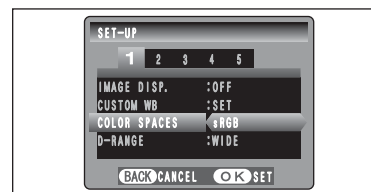

Selects the color space used when pictures are taken. For normal photography, select sRGB. Adobe RGB (1998) is best for images to be used for commercial printing.

### D-RANGE

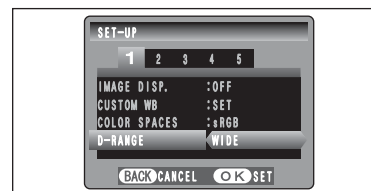

**WIDE:** Allows photography using a wide dynamic range that takes advantage of the particular characteristics of the Super CCD SR II. The continuous shooting speed and interval are slower than for standard mode (roughly double), so the number of continuous shots available roughly half.

**STANDARD:** The dynamic range is 100%, as on the previous digital camera (FinePix S2 Pro), but the continuous shooting speed and the number of continuous shots available are increased for easier shooting.

**AUTO ROTATE**



Detects whether the camera is used horizontally or vertically so that images are automatically rotated when opened in the optional dedicated software, Hyper-Utility Software HS-V2 Ver. 3.0.

- The camera may record the horizontal/vertical position information incorrectly during panning or when pictures are taken facing upwards or downwards. In such situations, select "OFF".
- Rotated display does not apply to playback images.

**FORMAT**

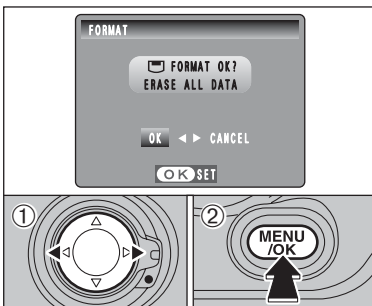

Initialize (format) the media for use with the camera.

Because initializing the media erases all the frames (files), including protected frames (files). Back up important frames (files) onto your computer or another media.

- 1 Press "◀" or "▶" to select "OK".
- 2 Pressing the "MENU/OK" button erases all the frames (files) and initializes the media.

- Always check the media to be formatted on the screen before proceeding.
  - Formatted media
    - ◻ FORMAT OK?: xD-Picture Cards
    - ◻ FORMAT OK?: CF/Microdrives
  - If "[CARD ERROR]", "[WRITE ERROR]", "[READ ERROR]" or "[CARD NOT INITIALIZED]" appears, see P.134 for information before formatting the media.

**FRAME NO.**

	< CONT. >	< RENEW >
	0001 ⋮ 0005	0001 ⋮ 0005
↓		
	0006 ⋮ 0010	0001 ⋮ 0005

\* Formatted media used for both A and B.

Specifies whether frame numbers are assigned consecutively from previous numbers or begin again.

**CONT.** : Pictures are stored beginning from the highest file number stored on the last media used.

**RENEW:** Pictures are stored on each media beginning with a file number "0001".

Setting this function to "CONT." makes file management easier as it ensures that file names are not duplicated when images are downloaded to a PC.

- When the camera settings are "RESET", the frame number setting ("CONT." or "RENEW") is changed to "CONT." and the frame number itself does not return to "0001".
- When the media already contains image files with file numbers higher than the highest file number on the last media, images are stored beginning from the highest file number on the current media.

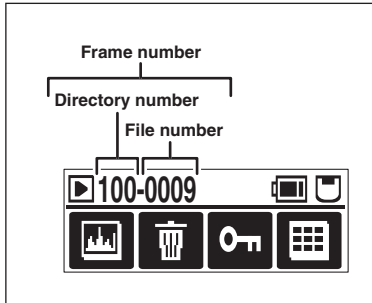

Check the file number by viewing the image. The last 4 digits of the 7-digit number are the file numbers, while the first 3 digits show the directory number.

- When changing the media, always turn the camera off before opening the slot cover. Opening the slot cover without turning the camera off may cause the frame number memory to not function.
- File number runs from 0001 to 9999. Once 9999 is exceeded, the directory number changes from 100 to 101. The maximum number is 999-9999.
- The displayed frame number may differ for images photographed on other cameras.
- When "[FRAME NO. FULL]" appears, see P.134.

**DISCHARGING RECHARGEABLE BATTERIES**

The "Discharging rechargeable batteries" function can only be used with Ni-MH batteries.

Use the "Discharging rechargeable batteries" function in the following situations:

- When the batteries only last for a short time after being charged normally
- When the batteries have not been used for a long period
- When you purchase new Ni-MH batteries

Do not use the "Discharging rechargeable batteries" function while using the AC power adapter. In these situations, the Ni-MH batteries will not be discharged due to the external power supply.

**1**

**2**

- 1 Press "◀" or "▶" to move to option 4 and then press "▲" or "▼" to select "DISCHARGE".
- 2 Press "▶".

- 1 Press "◀" or "▶" to select "OK".
- 2 Press the "MENU/OK" button. The screen changes and discharging begins. When the battery level indicator blinks red and discharging ends, the camera turns off.

To cancel discharging, press the "BACK" button.

LIVE IMAGE

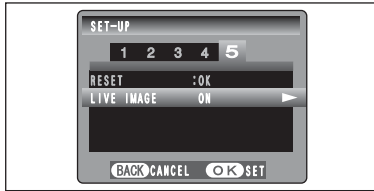

To manually focus the image more sharply or to check the image, you can view the image in black and white on the LCD monitor while adjusting the focus. The live image is only displayed for 30 seconds. Adjust the focus manually during this period. Live images are displayed using the actual aperture setting.

Use this feature in "M" (Manual focus) mode.

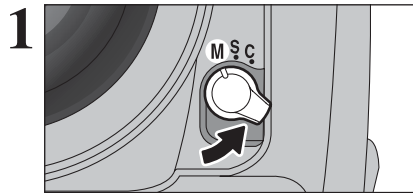

Set the focus mode selector switch to "M".

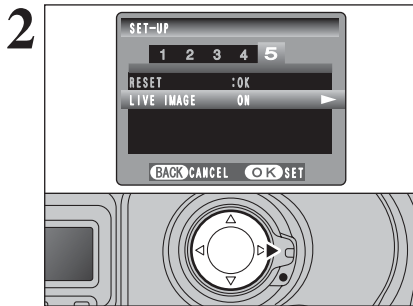

In the SET-UP screen, select "LIVE IMAGE" and then press "MENU/OK". In the confirmation screen, press the "MENU/OK" button.

The flash fires when the internal flash pops up or when an external flash is connected and the live image is displayed.

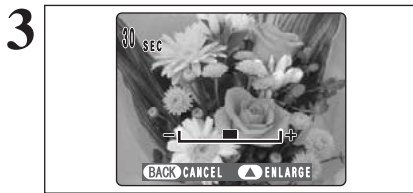

The live image is displayed for 30 seconds. Use "◀" or "▶" to adjust the brightness. In the live image display, press "▲" to enlarge the central part of the image and "▼" to return to the original image. To cancel live image display in progress, press the "BACK" button.

To view the live image, use the optional AC adapter AC-5VX. Continued use of live image display can cause the CCD to overheat, resulting in coarseness or noise such as white spotting in images photographed subsequently. If this occurs, turn the camera off and wait for it to cool down.

If you display consecutive live images, the initial brightness setting is retained for the second and subsequent images. The setting is reset when you turn the camera off (or the Auto Power Off function is triggered) and has to be set again.

The Auto Exposure Bracketing settings are canceled when the live image is displayed. Wait until live image display is finished before specifying the Auto Exposure Bracketing settings.

TWO-BUTTON RESET

Two-Button Reset lets you instantly reset specified settings to their original initial settings.

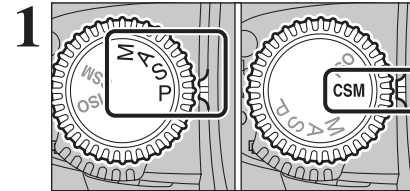

Set the exposure mode dial to "P", "S", "A", "M" or "CSM" and select the settings to be reset.

Exposure mode dial	Reset Settings																
"P", "S", "A", "M"	The photography functions are reset as shown below. <table border="1"> <thead> <tr> <th>Function</th> <th>Condition</th> </tr> </thead> <tbody> <tr> <td>Focus area</td> <td>Center</td> </tr> <tr> <td>Flexible Program</td> <td>Cancelled</td> </tr> <tr> <td>Exposure compensation</td> <td>Cancelled</td> </tr> <tr> <td>Auto Exposure Bracketing</td> <td>Cancelled</td> </tr> <tr> <td>Auto Exposure Lock</td> <td>Cancelled</td> </tr> <tr> <td>Flash Synchro mode</td> <td>Front Synchro mode</td> </tr> <tr> <td>Flash exposure compensation</td> <td>Cancelled</td> </tr> </tbody> </table>	Function	Condition	Focus area	Center	Flexible Program	Cancelled	Exposure compensation	Cancelled	Auto Exposure Bracketing	Cancelled	Auto Exposure Lock	Cancelled	Flash Synchro mode	Front Synchro mode	Flash exposure compensation	Cancelled
Function	Condition																
Focus area	Center																
Flexible Program	Cancelled																
Exposure compensation	Cancelled																
Auto Exposure Bracketing	Cancelled																
Auto Exposure Lock	Cancelled																
Flash Synchro mode	Front Synchro mode																
Flash exposure compensation	Cancelled																
"CSM"	<ul style="list-style-type: none"> <li>All the custom settings are reset.</li> <li>The ISO sensitivity is reset to 200.</li> </ul>																

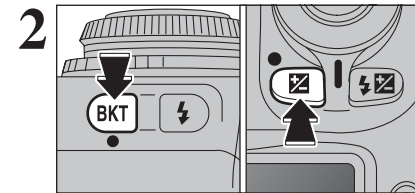

Hold down the "BKT" and "Fn" buttons together for at least 2 seconds (green markings are positioned alongside). The top display panel flashes briefly and the settings are reset.

3 When the reset is finished, set the exposure mode dial to a setting other than "CSM".

## CUSTOM SETTING (CSM)

The custom settings allow to modify camera functions such as how information is displayed in the viewfinder and which functions are assigned to which buttons.

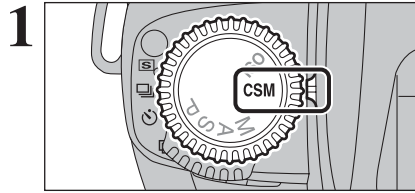

Set the Exposure mode dial to "CSM".

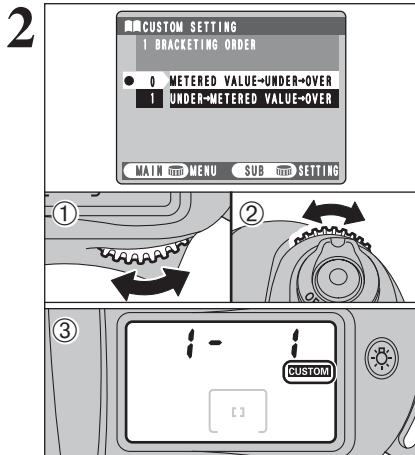

- ① Turn the Main-command dial to select an option.
- ② Turn the Sub-command dial to change the setting.
- ③ "CUSTOM" appears on the top display panel.

- 3 When you have finished the settings, set the exposure mode dial to a setting other than "CSM".  
 The custom settings are retained when the camera is turned off.

### Cancelling custom settings

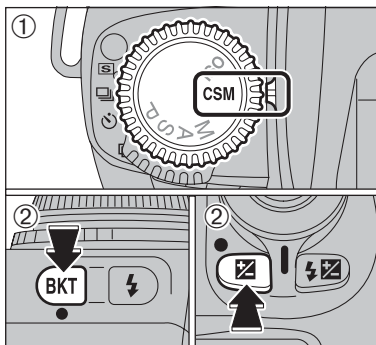

- ① Set the Exposure mode dial to "CSM".
  - ② Hold down the "BKT" and "CSM" buttons together for at least 2 seconds (green markings are positioned alongside).
- The top display panel flashes briefly and the settings are reset.
- All the custom settings are reset to their default values.
  - The ISO sensitivity is reset to 200.

### Custom settings list

No.	Setting	Display	Details
1	BRACKETING ORDER	0: METERED VALUE ➡ UNDER ➡ OVER (default) 1: UNDER ➡ METERED VALUE ➡ OVER	Allows you to change the compensation sequence when auto exposure bracketing is used.
2	ON-DEMAND GRID LINES DISPLAY	0: OFF (default) 1: ON	If you display the On-Demand Grid Lines, you can use the intersections of the horizontal and vertical lines to position your main subject in the shot or align one of the horizontal lines with the horizon. This allows you to compose the desired shot while monitoring the subject's size and the balance.
3	ILLUMINATION FOR FOCUS AREA	0: AUTO (default) 1: OFF 2: ON	Specifies the illumination used for the focus area in the viewfinder.
4	FOCUS AREA SELECTION	0: NORMAL (default) 1: ENABLES ROTATION	Selecting cyclic focus area selection allows you to select the opposite focus area without changing which part of the 4-direction button you have to press.
5	AE-LOCK	0: DISABLED (default) 1: ACTIVATED	Set this parameter to "1" to apply the AE lock when the shutter button is pressed half way.
6	LONG EXP. (BULB) AT MANUAL MODE	0: DISABLED (default) 1: ACTIVATED	Select "1" to take bulb shots in the "M" exposure mode.
7	CLOSEST-SUBJECT-PRIORITY DYNAMIC AF AT AF-S MODE	0: ENABLED (default) 1: DISABLED	If you select "1", Closest-subject Priority Dynamic AF is not used in AF-S mode.
8	CLOSEST-SUBJECT-PRIORITY DYNAMIC AF AT AF-C MODE	0: DISABLED (default) 1: ENABLED	If you select "1", Closest-subject Priority Dynamic AF is used in AF-C mode.
9	AE/AF LOCK BUTTON	0: AE/AF LOCK (default) 1: AE LOCK ONLY 2: AF LOCK ONLY 3: AE REMAINS LOCKED 4: AF OPERATION	Normally, AE lock (exposure recording) and AF lock (focus lock) are both applied concurrently when you press the "AE-L/AF-L" button. However, this can be changed so that only AE lock or only AF lock is applied, or so that that the AE lock status is maintained. If the AE/AF lock is used with the "Maintain AE lock" setting, pressing the "AE-L/AF-L" button again or releasing the shutter cancels the lock. In addition, though the auto focus (AF) normally operates when the shutter button is pressed down halfway, you can change this so that AF operates when the "AE-L/AF-L" button is pressed. (In this case, AF does not operate when the shutter button is pressed down halfway.)
10	COMMAND DIAL FUNCTIONS	0: DISABLED (default) 1: ENABLED	Use this setting to change the Main-command dial and Sub-command dial operation during photography. 0: Main: Changes the shutter speed. Sub: Changes the aperture. 1: Main: Changes the aperture. Sub: Changes the shutter speed.
11	MULTIPLE EXPOSURE	0: SINGLE SHUTTER RELEASE (default) 1: CONTINUOUS SHUTTER RELEASE	Changing this setting allows you to use continuous shooting for multiple exposure shots.



## CUSTOM SETTING (CSM)

No.	Setting	Display	Details
12	AUTO POWER OFF	0: OFF 15: 15 SEC. (default) 2: 2 MIN. 5: 5 MIN.	Sets the delay time until the Auto Power Off function operates.
13	SELF-TIMER DURATION	2: 2 SEC. 5: 5 SEC. 10: 10 SEC. (default) 20: 20 SEC.	Sets the running time for the self-timer.
14	LCD ILLUMINATION	0: OFF (default) 5: 5 SEC. 15: 15 SEC.	Allows you to change the settings so that the LCD illumination lights when buttons are used.
15	AF-ASSIST ILLUMINATOR	0: ON (default) 1: OFF	Allows you to prevent the built-in AF-assist illuminator from operating. Note that this may prevent the auto focus from successfully setting the focus in some cases.

## 6 Connection

## CONNECTING TO A TV / USING THE AC POWER ADAPTER

### Connecting to a TV

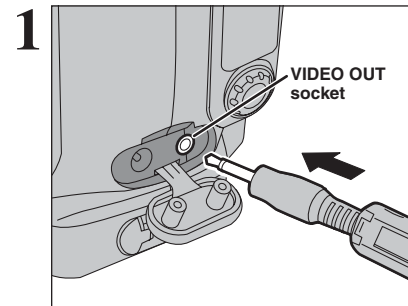

Turn off the camera and TV. Open the terminal cover and plug the bundled video cable into the camera's "VIDEO OUT" (video output) socket.

⚠ If there is a power outlet available, connect the AC Power Adapter AC-5VX.

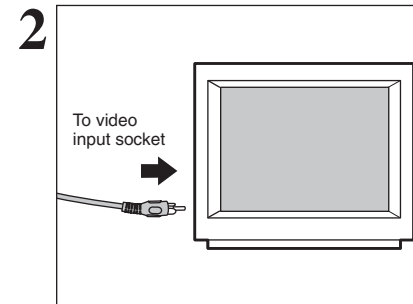

Plug the other end of the cable into the video input socket on the TV. Then turn the camera and TV on and take pictures or play back images as you would normally.

⚠ Refer to the instructions provided with your TV for more information on video input for your TV.

### Using the AC Power adapter (sold separately)

The AC Power Adapter is useful since it allows you to take pictures, play back images (connected to a TV, etc.) and connect to a computer without worrying about using up the battery charge.

- **Compatible AC power adapter**  
Model: AC-5VX

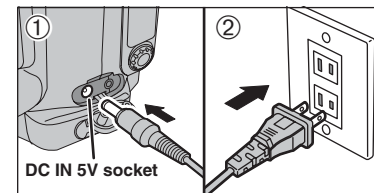

Check that the camera is turned off. Open the terminal cover and plug the AC power adapter connector into the "DC IN 5V" socket. Then plug the AC power adapter into a power outlet.

- ⚠ Use only the FUJIFILM products listed above.
- ⚠ See P.130 for notes on using the AC power adapter.
- ⚠ The socket-outlet shall be installed near the equipment and shall be easily accessible.
- ⚠ The shape of the plug and socket-outlet depends on the country of use.

## CONNECTING TO A COMPUTER

The "Connecting to a computer" section explains how to connect the camera to your computer using the USB cable (IEEE 1394 cable) and describes the functions you can use once the camera and computer are connected.

If the power cuts out during data transmission, the data will not be transmitted correctly. Always use the AC power adapter when connecting the camera to a computer.

Refer to Software Quick Start Guide the first time you connect the camera to your computer.

Install the software first. Do not connect the camera with the computer before installing all the software.



CD-ROM  
(Software for FinePix)

● If your PC supports USB 2.0 (High-speed USB), data can be transferred faster than with previous USB versions.

⚡ This camera does not support IEEE 1394b (FireWire 800). Use IEEE 1394 (FireWire 400).

### DSC (Mass storage device) mode

This mode provides a simple way to read images from a media and store images onto a media. The USB or IEEE 1394 (FireWire) interface connection can be used for high-speed file transfer (⇒P.115). To connect via an IEEE 1394 port, check that the interface is OHCI compliant and then refer to the table below to check whether it is supported by your operating system.

■ Operating system compatibility chart (Windows) ✓: Can be connected —: Cannot be connected

OS Connection type	Windows 98	Windows 98 SE (Second Edition)	Windows Me (Millennium Edition)	Windows 2000 (Professional)	Windows XP
IEEE 1394	—	✓*2	✓	✓	✓
USB	✓*1	✓	✓	✓	✓

\*1 Can be used by installing the driver from the bundled CD-ROM.

\*2 Select Windows Update from the Start button menu and update the 1394 device driver (Your system must be capable of connecting to the Internet).

■ Operating system compatibility chart (Macintosh) ✓: Can be connected

OS Connection type	Mac OS 9.2.2*1	Mac OS X*2
IEEE 1394	✓	✓
USB	✓	✓

\*1 Contact Apple Computers (<http://www.apple.com>) for information on software updates.

\*2 Versions 10.2.6 to 10.3.5 as at November 2004. Refer to the FUJIFILM website for information on supported operating systems.  
<http://home.fujifilm.com/products/digital/>

### IEEE 1394 photography function

For information on taking pictures using IEEE 1394, refer to the Hyper Utility Software HS-V2 Ver.3.0 (or later) Quick Start Guide.

## USE AT DSC MODE

### 1 Set a camera

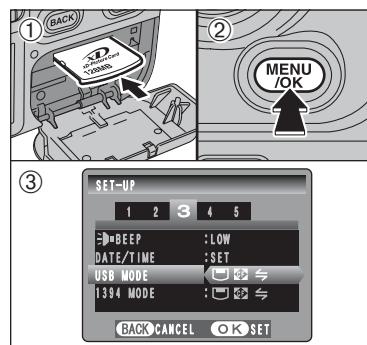

- ① Insert a media with images into the camera.
- ② Turn the camera on and press the "MENU/OK" button.
- ③ Select "USB MODE" or "1394 MODE" in the SET-UP menu (⇒P.101) and then turn the camera off.

- ⚡ Use the AC Power Adapter AC-5VX (sold separately) for the connection (⇒P.113). If shutting off power supply during communication, the files on the media may be damaged.
- ⚡ If inserting an xD-Picture Card and a CF/Microdrive into the camera at the same time, images will be recorded onto the media selected as the "MEDIA" (⇒P.102).

### 2 Connect a camera to a computer

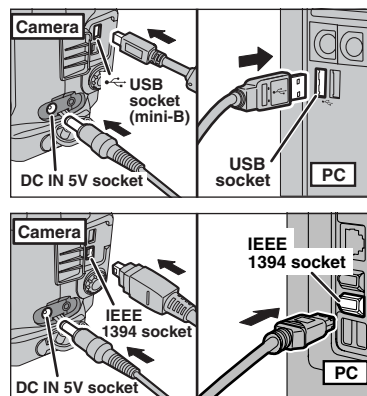

- ① Turn your PC on.
- ② Connect the camera to the PC using the USB cable (mini-B) or IEEE 1394 cable.
- ③ Turn the camera on.

- ⚡ Always use the cable provided with your camera. If you use other cable, your camera may not work correctly.
- ⚡ Make sure that the USB cable (mini-B) or IEEE 1394 cable is connected correctly and is pushed in.
- ⚡ Do not connect the USB cable (mini-B) and the IEEE 1394 cable at the same time.

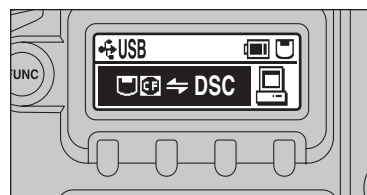

- The access lamp blinks when the camera and computer are exchanging data.
- "DSC" is displayed on rear display panel.
- Power save and Auto power off are disabled during DSC connection.

- ⚡ Before replacing the media, always disconnect the camera from the PC using the procedure on P.116.
- ⚡ Do not disconnect the USB cable (mini-B) or IEEE 1394 cable while communication is in progress. If shutting off power supply during communication, the files on the media may be damaged.

## CONNECTING TO A COMPUTER

### Disconnecting the camera

- Quit all applications (FinePixViewer etc.) that are using the camera.
- Perform the steps shown below before you turn the camera off. This procedure differs depending on the operating system software (or PC) you are using.

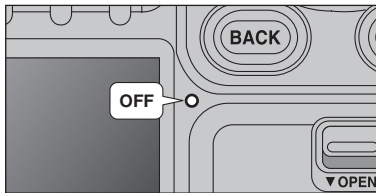

Check that the access lamp is off (no data is being exchanged with the computer).

In some cases, the camera and computer may still be communicating even after the "Copying" message disappears from the computer screen. Always check that the access lamp is off.

### Windows 98/98 SE (USB)

No PC operation is needed.

### Windows 98 SE (IEEE 1394) /Me/2000 Professional/XP

- Right-click the removable disk icon in the "My Computer" window and select Eject. This step is only required in Windows Me.

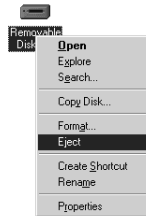

- Left-click the Eject icon in the taskbar and select "USB Disk".

\* Screen for Windows XP



- The menu option shown below appears. Click on this option.

\* Screen for Windows XP

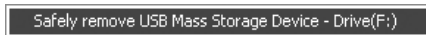

- The "Safe To Remove Hardware" message box appears. Click the [OK] button or the close button.

### Macintosh

Drag the "Removable drive" icon on the desktop to the Trash.

- When you drag the icon to the Trash, "REMOVE OK" appears on the camera's screen.

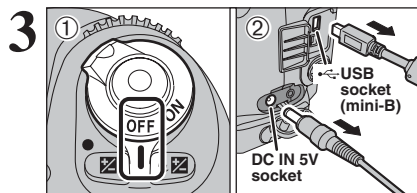

- Turn the camera off.
- Unplug the USB cable (mini-B) or IEEE 1394 cable from the camera.

## CONNECTING THE CAMERA DIRECTLY TO THE PRINTER — PictBridge FUNCTION

When a printer that supports PictBridge is available, images can be printed by connecting the camera directly to the PictBridge-compatible printer without using a PC.

- In PictBridge function, images photographed on other than a camera may not be printed.
- Always turn the camera off when disconnecting or connecting the USB cable. Connecting the camera to the printer while the camera is turned on could damage the media.

### Specifying images for printing on the camera

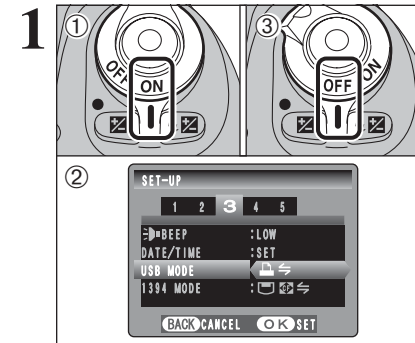

- Set the Power switch to "ON".
- Select "PictBridge" in "USB MODE" in the "SET-UP" menu (P.101).
- Set the Power switch to "OFF" to turn the camera off.

Do not connect to a PC when the USB mode setting is set to "PictBridge". See P.137 if you connect to a PC by mistake.

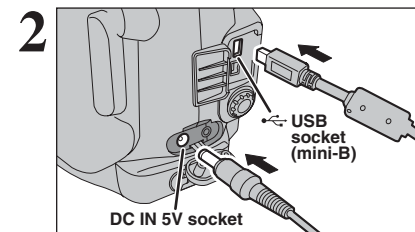

- Connect the camera to the printer using the USB cable (mini-B).
- Turn the printer on.

- The camera cannot be used to specify printer settings such as the paper size and print quality.
- Please connect the AC Power Adapter AC-5VX (sold separately) to your camera.
- Use a media that was formatted on the camera.

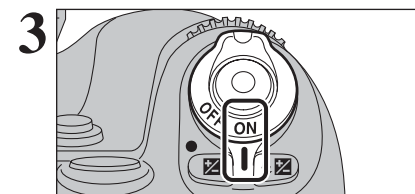

Set the Power switch to "ON".

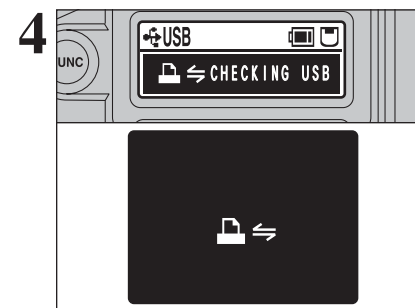

"CHECKING USB" appears on the rear display panel for a few moments and then the menu screen appears on the LCD monitor.

- If the menu does not appear, check whether the USB mode setting is "PictBridge".
- Depending on the printer, some functions are disabled.

Continued

## CONNECTING THE CAMERA DIRECTLY TO THE PRINTER — PictBridge FUNCTION

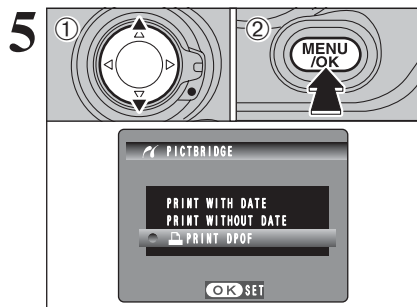

- 1 Press "▲" or "▼" to select "PRINT DPOF".
- 2 Press the "MENU/OK" button.

- ⚠ When "NOT SET DPOF" appears, the DPOF settings are not specified.
- ⚠ To use DPOF printing, the DPOF settings must be specified on FinePix S3 Pro beforehand (⇒P.94).
- ⚠ Even when "WITH DATE" is specified in the DPOF settings, the date is not inserted on printers that do not support date printing.

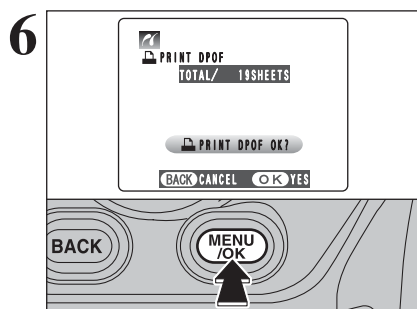

Press the "MENU/OK" button to download the data to the printer and print the frames specified in the DPOF settings.  
Press the "BACK" button to return to step 5.

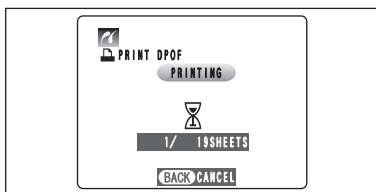

- ⚠ Press the "BACK" button to cancel the printing. Depending on the printer, the printing may not be canceled immediately or printing may stop midway through. When printing stops midway, briefly turn the camera off and then on again.

### Specifying images for printing without using DPOF (single-frame printing)

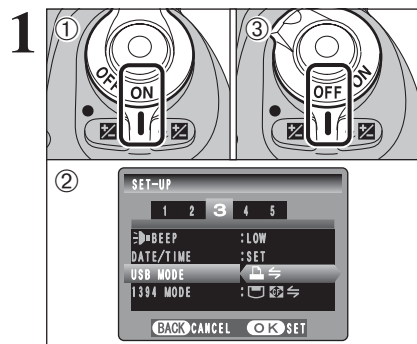

- 1 Set the Power switch to "ON".
- 2 Select "USB" in "USB MODE" in the "SET-UP" menu (⇒P.101).
- 3 Set the Power switch to "OFF" to turn the camera off.

- ⚠ Do not connect to a PC when the USB mode setting is set to "USB". See P.137 if you connect to PC by mistake.

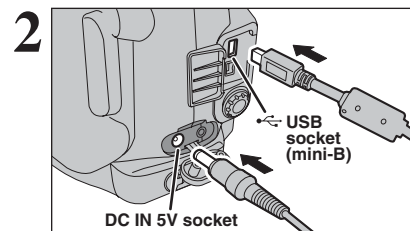

- 1 Connect the camera to the printer using the USB cable (mini-B).
- 2 Turn the printer on.

- ⚠ The camera cannot be used to specify printer settings such as the paper size and print quality.
- ⚠ Please connect the AC Power Adapter AC-5VX (sold separately) to your camera.
- ⚠ Use a media that was formatted on the camera.

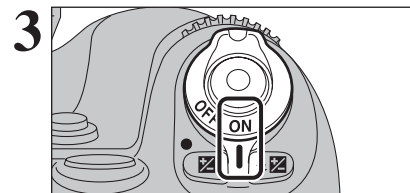

Set the Power switch to "ON".

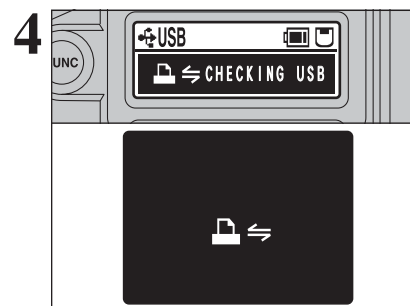

"CHECKING USB" appears on the rear display panel for a few moments and then the menu screen appears on the LCD monitor.

- ⚠ If the menu does not appear, check whether the USB mode setting is "USB".
- ⚠ Depending on the printer, some functions are disabled.

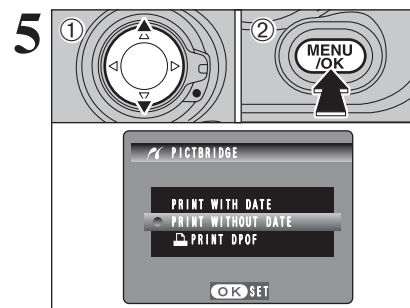

- 1 Press "▲" or "▼" to select "PRINT WITH DATE" or "PRINT WITHOUT DATE". If "PRINT WITH DATE" is selected, the date is imprinted on your prints.
- 2 Press the "MENU/OK" button.

- ⚠ "PRINT WITH DATE" is not available when the camera is connected to a printer that does not support date printing.

## CONNECTING THE CAMERA DIRECTLY TO THE PRINTER — PictBridge FUNCTION

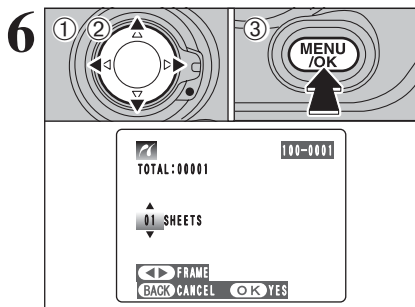

- ① Press “◀” or “▶” to display the frame (file) for which you want to specify PRINT settings.
- ② Press “▲” or “▼” to set a value up to 99 as the number of copies of the frame (file) to be printed. For frames (files) that you do not want printed, set the number of prints to 0 (zero). To specify more PRINT settings, repeat steps ① and ②.
- ③ Press the “MENU/OK” button.

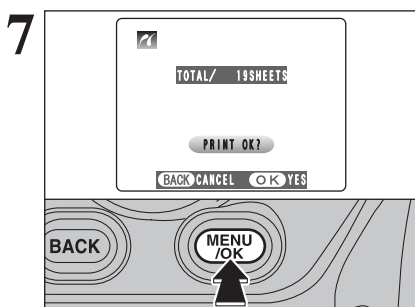

Always press the “MENU/OK” button after the settings are completed.

Press the “BACK” button to return to step 5.

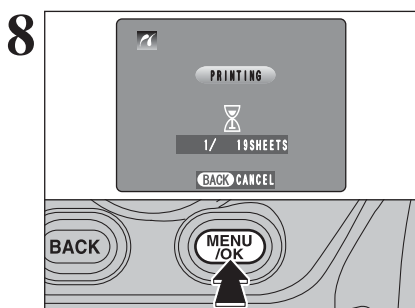

Press the “MENU/OK” button to download the data to the printer and start printing the specified number of prints.

Press the “BACK” button to cancel the printing. Depending on the printer, the printing may not be canceled immediately or printing may stop midway through. When printing stops midway, briefly turn the camera off and then on again.

### Disconnecting the printer

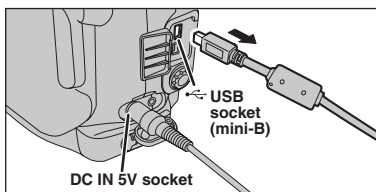

- ① Check that “PRINTING” is not displayed on the camera’s screen.
- ② Turn the camera off. Unplug the USB cable (mini-B).

## System Expansion Options

By using the FinePix S3 Pro together with other optional FUJIFILM products, your system can be expanded to fill a wide range of uses.

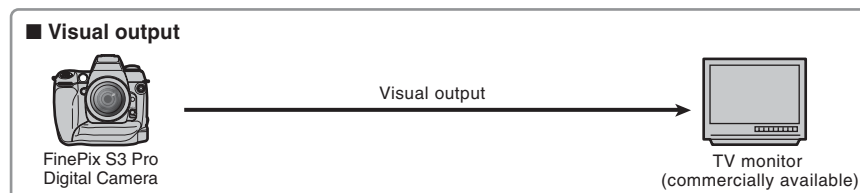
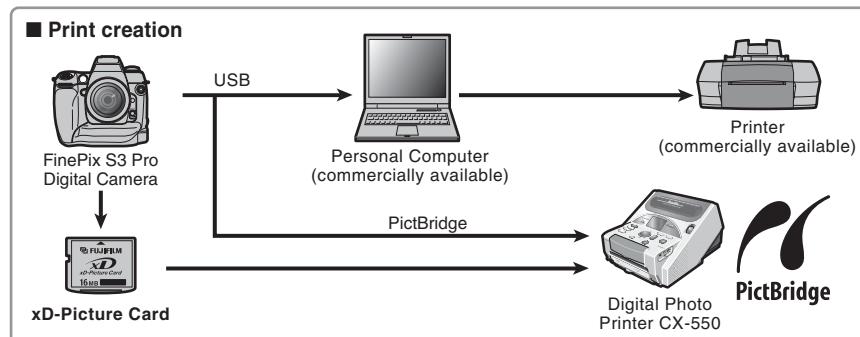
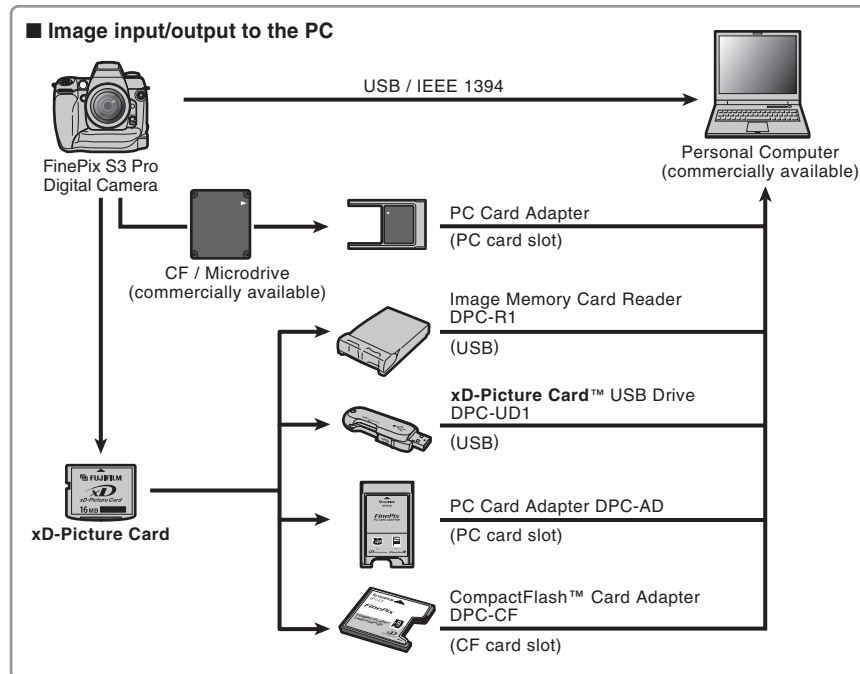

## Accessories Guide

► Accessories (sold separately) can make taking pictures with the FinePix S3 Pro even easier. For information on how to attach and use accessories, refer to the instructions provided with the accessory used.

Visit the FUJIFILM web site for the latest information on camera accessories.

<http://home.fujifilm.com/products/digital/index.html>

### ● xD-Picture Card

These are separately available **xD-Picture Cards**.

Use the following **xD-Picture Card**:

DPC-16 (16 MB)/DPC-32 (32 MB)/DPC-64 (64 MB)/DPC-128 (128 MB)/  
DPC-256 (256 MB)/DPC-512 (512 MB)



### ● AC Power Adapter AC-5VX

Use the AC-5VX when taking pictures or play back images for long periods or when the FinePix S3 Pro is connected to a personal computer.

\* The shape of the AC power adapter, the plug and socket outlet depend on the country.



### ● Fujifilm Rechargeable Battery 2HR-3UF

The 2HR-3UF includes 2 pieces of high-capacity AA-size Nickel-Metal Hydride (Ni-MH) batteries.



### ● Fujifilm Battery Charger with Battery BK-NH2 (With Euro type or UK type plug)

The BK-NH2 includes the quick battery charger BCH-NH2 and 2 Ni-MH batteries.

The BCH-NH2 can charge 2 Ni-MH batteries in approximately 120 minutes.

Up to 4 Ni-MH batteries can be charged simultaneously.

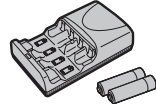

### ● Image Memory Card Reader DPC-R1

The DPC-R1 provides a quick and easy way to transfer images back and forth between your PC and an image memory card (**xD-Picture Card** and SmartMedia). The DPC-R1 uses the USB interface for high-speed file transfer.

- Compatible with Windows 98/98 SE, Windows Me, Windows 2000 Professional, Windows XP or iMac, Mac OS 8.6 to 9.2.2, Mac OS X (10.1.2 to 10.2.2) and models that support USB as standard.

- Compatible with **xD-Picture Card** of 16 MB to 512 MB, and SmartMedia of 3.3 V, 4 MB to 128 MB.



### ● PC Card Adapter DPC-AD

The PC Card Adapter allows the **xD-Picture Card** and SmartMedia to be used as a PC Card Standard ATA-compliant (PCMCIA 2.1) PC card (Type II).

- Compatible with **xD-Picture Card** of 16 MB to 512 MB, and SmartMedia of 3.3 V, 2 MB to 128 MB.



### ● CompactFlash™ Card Adapter DPC-CF

Loading an **xD-Picture Card** into this adapter allows you to use the card as a CompactFlash card (Type I).

- Windows 95/98/98 SE/Me/2000 Professional/XP

- Mac OS 8.6 to 9.2/X (10.1.2 to 10.1.5)



### ● xD-Picture Card™ USB Drive DPC-UD1

This is a compact card reader for **xD-Picture Cards**. Simply plug the drive into the USB port to read and write data to an **xD-Picture Card**. (No driver installation is required except on Windows 98/98 SE.)

- Compatible with **xD-Picture Card** of 16 MB to 512 MB

- Windows 98/98 SE/Me/2000 Professional/XP

- Mac OS 9.0 to 9.2/X (10.0.4 to 10.2.6)



### ● Hyper-Utility Software HS-V2 Ver.3.0

- Offers PC-based functions such as browsing, two-image comparison, image sorting and organizing using a marker function, and image analysis using histogram and highlight warning displays for images shot on a digital camera.
- Allows you to specify the output image size and the processing parameters (tone curve, white balance, sharpness, color and dynamic range) for CCD-RAW files and also allows you to convert them to ordinary image files (16-bit/8-bit TIFF or Exif JPEG).
- Allows images shot on a FinePix S3 Pro to be downloaded directly to a PC without using a recording media by connecting the camera to the PC's IEEE 1394 interface (Photography function).
- Provides a range of other functions for using photographed images in various ways, including printing, contact-sheet file creation and slide shows.
- Refer to the product package for detailed information on specifications and system requirements.

## Notes on Using Your Camera Correctly

► Be sure to read this information in conjunction with “Safety Notes” (⇒P.141), to ensure that you use your camera correctly.

### ■ Places to Avoid

Do not store or use the camera in the following types of locations:

- In the rain or in very humid, dirty or dusty places.
- In direct sunlight or in places subject to extreme temperature rises, such as in a closed car in summer.
- Extremely cold places.
- Places subject to strong vibration.
- Places affected by smoke or steam.
- Places subject to strong magnetic fields (such as near motors, transformers or magnets).
- In contact with chemicals such as pesticides or next to rubber or vinyl products for long periods of time.

### ■ Notes on Immersion in Water or Sand

The FinePix S3 Pro is particularly adversely affected by water and sand. When you are at the beach or close to water, ensure that the camera is not exposed to water or sand. Take care also not to place the camera on a wet surface. Water or sand inside the camera can cause faults that may be irreparable.

### ■ Notes on Condensation

If the camera is carried suddenly from a cold location into a warm place, water droplets (condensation) may form on the inside of the camera or on the lens. When this occurs, switch the camera off and wait an hour before using the camera. Condensation may also form on the media. In this event, remove the media and wait a short time before using it again.

### ■ When the Camera is Unused for Long Periods

If you do not intend to use the camera for a long period of time, remove the battery and the media card before storing the camera.

### ■ Cleaning Your Camera

- Use a blower brush to brush away any dust on the lens, LCD monitor surface, viewfinder or external AF sensor and then gently wipe the camera with a soft, dry cloth. If any soiling remains, apply a small amount of lens cleaning liquid to a piece of FUJIFILM lens cleaning paper and wipe gently.
- Do not scratch hard objects against the lens, LCD monitor screen or viewfinder as these surfaces are easily damaged.
- Clean the body of the camera with a soft, dry cloth. Do not use volatile substances such as thinners, benzene or insecticide, as these may react with camera body and cause deformation or remove the coating.
- This camera is equipped with a CCD photosensitive element. This CCD is located behind the shutter screen. If dust or other soiling attaches to the surface of the CCD and pictures are then taken, this soiling may appear as spots in the image, depending on the camera settings and the type of subject. If this occurs, the CCD must be cleaned. Because the surface of the CCD is extremely fragile, wherever possible the camera should be returned to an authorized FUJIFILM dealer for cleaning (for a charge). Any repairs carried out by an authorized FUJIFILM service facility to CCDs that were scratched or damaged during cleaning by the customer will be charged to the customer. Note that such repairs will probably involve replacing the CCD and will be expensive.

⚠ Take the following precautions to ensure that no dirt or dust gets onto the CCD:

- Before a FUJIFILM digital camera is shipped from the factory, it is carefully checked for dust inside the camera and on the surface of the CCD to ensure that it conforms to FUJIFILM standards.
- Bear in mind also that some types of soiling on the CCD surface cannot be removed even by an authorized FUJIFILM dealer.  
Should this occur, you can use features such as the despeckling function provided in the image processing software to remedy the problem.

### ■ Using the Camera Overseas

When traveling overseas, do not place your camera in the check-in baggage. Baggage handling at airports may subject baggage to violent shocks, and the camera may be damaged internally even when no external damage is visible.

## Cleaning the CCD

This camera is equipped with a CCD photosensitive element. This CCD is located behind the shutter screen.

If dust or other soiling attaches to the surface of the CCD and pictures are then taken, this soiling may appear as spots in the image, depending on the camera settings and the type of subject. If this occurs, the CCD must be cleaned. Because the surface of the CCD is extremely fragile, wherever possible the camera should be returned to an authorized FUJIFILM dealer for cleaning (for a charge).

Any repairs carried out by an authorized FUJIFILM dealer to CCDs that were scratched or damaged during cleaning by the customer will be charged to the customer. Note that such repairs will probably involve replacing the CCD and will be expensive.

### ◆ Dust inside the camera and on the surface of the CCD ◆

- Before a FUJIFILM digital camera is shipped from the factory, it is carefully checked for dust inside the camera and on the surface of the CCD to ensure that it conforms to FUJIFILM standards.
- Bear in mind also that some types of soiling on the CCD surface cannot be removed even by an authorized FUJIFILM dealer.  
Should this occur, you can use features such as the despeckling function provided in the image processing software to remedy the problem.

### Checking the condition of the CCD surface

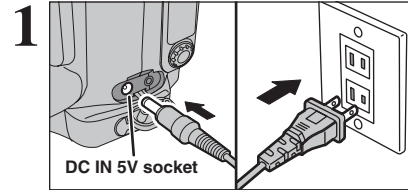

1 Check that the camera is turned off.

Open the terminal cover and fully insert the connector plug from the AC power adapter AC-5VX (sold separately) into the “DC IN 5V” socket. Then plug the AC power adapter into the power outlet.

- ⚠ When cleaning the camera, always use the AC power adapter AC-5VX (sold separately) to prevent camera damage due to the mirror dropping down or the shutter closing.
- ⚠ See P.130 for more information on using the AC power adapter.

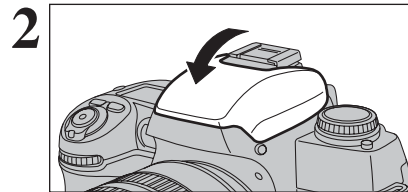

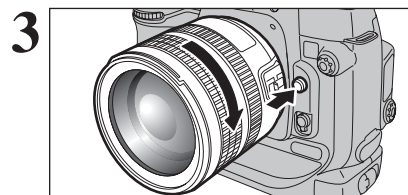

2 Press the built-in flash down to stow it away.

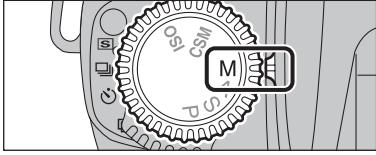
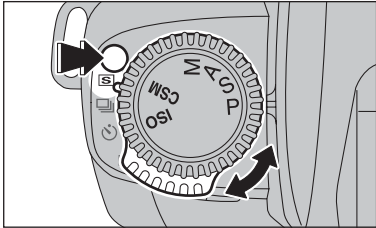

3 Hold down the Lens release button and turn the lens in the direction of the arrow.

## Cleaning the CCD

- 4**  Set the Exposure mode dial to "M".
- 5**  Hold down the Release mode switch unlock button and set the Release mode switch to "S" (single-frame).
- 6**  Hold down both the Synchro mode button and the LCD illumination button and turn the camera on.

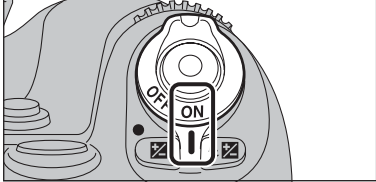
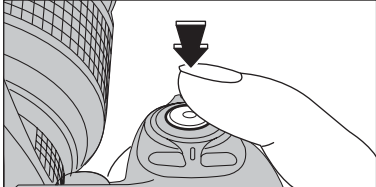
- 7**  When you press the shutter button, the mirror flips up and the shutter opens and stays open.

 **!** When you release the shutter button, the mirror stays up.

- 8** Hold the camera so that the sun shines on the CCD and check the surface for dust.

Surface clean

Surface soiled

Contact a FUJIFILM dealer and request CCD cleaning.

Clean the CCD yourself.

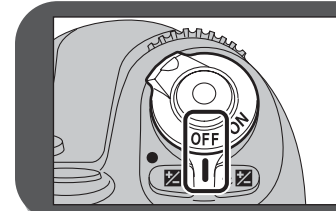

Turn the camera off and attach a lens or body cap to the camera.

**!** When you turn the camera off, the mirror drops down and the shutter closes at the same time. Ensure that your fingers are not caught inside the camera.

### Starting CCD cleaning

Take great care to avoid scratching or damaging the CCD during cleaning, as you will be responsible for the possibly high cost of repairs (or replacement) by an authorized FUJIFILM dealer.

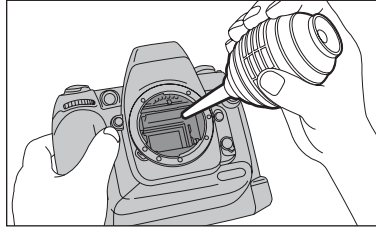
- 1**  Use a blower (without a brush attached) to remove any soiling on the CCD surface.

**!** Use a blower that does not have a brush attached. Using a blower brush to clean soiling from the CCD can scratch the CCD surface.
- 2** Check whether the dust has been removed from the CCD surface.

The blower has removed the dust (There are no oily marks or fingerprints).

There are oily marks or fingerprints left on the CCD that cannot be removed with the blower.

Proceed to step 3.

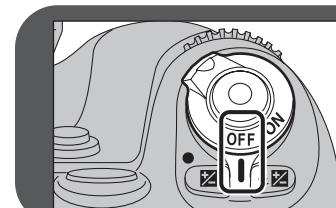

Turn the camera off and mount the lens or body cap on the camera.

**!** When you turn the camera off, the mirror drops down and the shutter closes at the same time. Ensure that your fingers are not caught inside the camera.



## Cleaning the CCD

### ◆ Ensure that you have the cleaning equipment ready ◆

- Cleaning swabs  
Sensor Swab (Photographic Solutions, Inc.)  
\* For information on suppliers outside Japan, visit the web site listed below  
(<http://www.photosol.com/swabproduct.htm>).
- Cleaning fluid  
Anhydrous ethanol, EE Cleaner (Olympus)

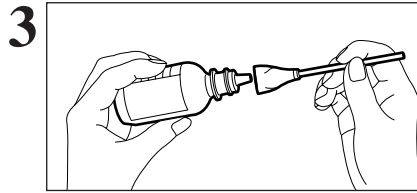

3 Moisten the bottom 5 mm (0.2 in) of the Sensor swab evenly with cleaning fluid.

- ⚠ Do not use the swab when it is dry or not moistened with cleaning fluid.

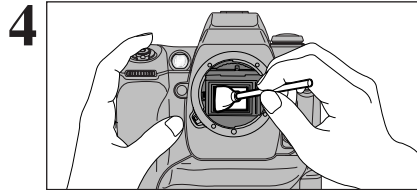

4 Slowly and gently wipe one side of the swab just once across the full width of the CCD from left to right.

5 Then wipe the other side of the Sensor swab across the full width of the CCD from left to right once more. Do not reuse Sensor swabs.

If this does not remove the soiling, repeat steps 3 to 5 with a new Sensor swab or contact an authorized FUJIFILM dealer.

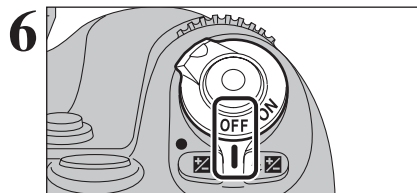

6 Turn the camera off and mount the lens or body cap on the camera.

- ⚠ When you turn the camera off, the mirror drops down and the shutter closes at the same time. Take care to ensure that your fingers are not caught inside the camera.

Always use this procedure to clean the CCD. Never clean the CCD in bulb photography mode. A current runs through the CCD in bulb photography mode and cleaning could cause damage.

## Notes on the Power Supply

### Applicable Batteries

- Use only nickel-metal hydride (Ni-MH) batteries with this camera. AA size alkaline, AA-size manganese or lithium batteries cannot be used.

### Notes on the Batteries

Incorrect use of the batteries could cause them to leak, become hot, ignite or burst. Always observe the precautions given below.

- Do not heat the batteries or throw them into a fire.
- Do not carry or store the batteries with metal objects such as necklaces or hairpins that could come into contact with the metal positive (+) and negative (-) poles of the battery.
- Do not expose the batteries to fresh or sea water, and take particular care to keep the terminals dry.
- Do not attempt to deform, disassemble or modify the batteries.
- Do not attempt to peel off or cut the battery casing.
- Do not drop, strike or otherwise subject the batteries to strong impacts.
- Do not use the batteries that are leaking, deformed, discolored or exhibit any other obvious abnormality.
- Do not store the batteries in very warm or moist locations.
- Keep the batteries out of reach of infant and young children.
- When loading the batteries into the camera, ensure that the battery polarity (+ and -) is as indicated on the camera.
- Do not use new batteries together with used batteries. In the case of rechargeable batteries, do not use charged and discharged batteries together. Do not use batteries of different types or brands together.
- If you do not intend to use the camera for a long period of time, remove the batteries from the camera (Note that if the camera is left with the batteries removed, the time and date settings are cleared).
- The batteries may feel warm immediately after being used. Before removing the batteries, switch the camera off and wait until the batteries cool down.
- When replacing the batteries, always fit 4 new batteries. Here, 'new batteries' refers to Ni-MH (nickel metal hydride) batteries that have recently been fully recharged together.
- In cold locations (at temperatures of +10°C/+50°F or below), battery performance deteriorates and the time for which they can be used shortens markedly. In cold conditions, put the batteries in your pocket or a similar place to warm them before loading them into the camera. If you use a body warmer to warm the batteries, ensure that they are not in direct contact with the warmer.
- Soil (such as fingerprints) on the battery terminals can markedly reduce the number of available shots. Carefully wipe the battery terminals clean with a soft dry cloth before loading the batteries.

⚠ If any liquid at all leaks from the batteries, wipe the battery compartment thoroughly and then load new batteries.

⚠ If any battery fluid comes into contact with your hands or clothing, flush the area thoroughly with water. Note that battery fluid can cause loss of eyesight if it gets into your eyes. If this occurs, do not rub your eyes. Flush the fluid out with clean water and contact your physician for treatment.

### Disposing of Batteries

When disposing of batteries, do so in accordance with your local waste disposal regulations.

### Using the AA-size Ni-MH Batteries

- As a power source in digital cameras, AA-size Ni-MH batteries are superior to alkaline batteries in several ways, such as allowing more shots to be taken with the camera. However, care must be taken with the way Ni-MH batteries are used if their original performance is to be maintained.
- Ni-MH batteries left unused in storage for long periods can become "deactivated". Also, repeatedly charging Ni-MH batteries that are only partially discharged can cause them to suffer from the "memory effect".
- Ni-MH batteries that are "deactivated" or affected by "memory" suffer from the problem of only providing power for a short time after being charged. To prevent this problem, discharge and recharge them several times using the camera's "Discharging rechargeable batteries" function. By repeating this cycle several times, the temporary reduction in performance caused by "memory" or "deactivation" can be remedied and the batteries can be restored to their original performance levels. Deactivation and memory are specific to Ni-MH batteries and are not in fact battery faults. See P.107 for the procedure for "Discharging rechargeable batteries".
- To charge Ni-MH batteries, use the battery charger (included). Refer to P.21 to make sure that the charger is used correctly.
- Do not use the battery charger to charge other batteries.
- Note that the batteries feel warm after being charged.
- Due to the way the camera is constructed, a small amount of current is used even when the camera is turned off. Note in particular that leaving AA-size Ni-MH batteries in the camera for a long period will overdischarge the batteries and may render them unusable even after recharging.
- Ni-MH batteries will self-discharge even when not used, and the time for which they can be used may be shortened as a result.
- Ni-MH batteries will deteriorate rapidly if overdischarged (e.g. by discharging the batteries in a flashlight). Use the "Discharging rechargeable batteries" function provided in the camera to discharge the batteries.
- Ni-MH batteries have a limited service life. If a battery can only be used for a short time even after repeated discharge-charge cycles, it may have reached the end of its service life.

## Notes on the Power Supply

### Notes on Using the Battery Charger

- Ni-MH batteries or the battery charger itself will become warm due to the power stored inside the batteries. This is normal and does not indicate a fault. Wherever possible, use the battery charger in a well-ventilated location.
- There may be vibration noises from inside the battery charger during use. This is normal and does not indicate a fault.
- Do not use the battery charger to charge batteries other than Ni-MH batteries.
- The battery charger could cause interference if placed close to a radio during charging. In this event, move the radio and charger further apart.
- Do not touch the connections or contact points on rechargeable batteries with other metal objects as this can cause a short circuit.
- Do not leave the battery charger in the following types of locations:
  - Extremely humidity or high temperatures, such as close to a heating appliance or in direct sunlight
  - Places with strong vibration
  - In very dusty places
- The battery charger accepts input voltages of 100-240 V AC at 50 or 60 Hz and can be used all over the world. However, the shape of the plug and socket-outlet depends on the country of use. Consult your travel agent for details.

### Battery Charger BCH-NH2 Specifications

Rated input	100-240 V AC, 50/60 Hz
Input capacity	16.21 VA (U.S.A and Canada) 10 W (other countries)
Rated output	DC1.2 V 565 mA (× 4)
Applicable batteries	AA-size Ni-MH Battery × 4
Charging time	Approx. 255 minutes
Dimensions	105 mm × 65 mm × 27.5 mm (4.1 in. × 2.6 in. × 1.1 in.) (L × W × D)
Mass (Weight)	Approx. 95 g (3.4 oz.) (excluding batteries)
Operating temperatures	0°C to +40°C (+32°F to +104°F)

### AC Power Adapter

Always use the AC Power Adapter AC-5VX (sold separately). The use of an AC Power adapter other than AC-5VX can cause damage to your digital camera.

- Use the AC power adapter for indoor use only.
- Plug the connection cord plug securely into the DC input terminal of the FUJIFILM Digital camera.
- Turn off the FUJIFILM Digital camera before disconnecting the cord from the FUJIFILM Digital camera's DC input terminal. To disconnect, pull out the plug gently. Do not pull on the cord.
- Do not use the AC power adapter with any device other than your camera.
- During use, the AC power adapter will become hot to the touch. This is normal.
- Do not take apart the AC power adapter. Doing so could be dangerous.
- Do not use the AC power adapter in a hot humid place.
- Do not subject the AC power adapter to strong shocks.
- The AC power adapter may emit a humming. But this is normal.
- If used near a radio, the AC power adapter may cause static. If this happens, move the camera away from the radio.

## Notes on the Media

### Image Memory Card

- This Image Memory Card is a new image recording media (**xD-Picture Card**) developed for digital cameras. The Image Memory Card consists of a semiconductor memory (NAND-type flash memory) to record digital image data.  
The recording process is electrically performed and enables erasure of existing image data as well as re-recording of new image data.
- When using a new Memory Card, or a Memory Card that has been formatted by a PC, be sure to format the card with your digital camera before using it.

### Microdrives

Microdrives are compact, lightweight hard disk drives that conform to the CF+ Type II standard. Due to their ample capacity for large image data files and their low per-megabyte recording cost, Microdrives provide a more economical way to save high-resolution image files.

### Protecting Your Data

- Images and movies may be lost or destroyed in the following situations. Please note that FUJIFILM assumes no responsibility for data that is lost or destroyed.
  1. Removal of the memory card or turning the power off while the memory card is being accessed (i.e., during record, erase, initialization, and playback operations).
  2. Improper handling and use of the memory card by the user or third party.
- Save your important data to another media (i.e., MO disk, CD-R, hard disk, etc.).

### Handling Media (all types)

- When inserting the media into the camera, hold the media straight as you push it in.
- Never remove the media or turn the camera off during data recording or erasing (media formatting) as this could be damaged to the media.
- Do not bend, drop or otherwise subject the media to strong force or shocks.
- Do not use or store these media in places with affected by strong static electricity or electrical noise.
- Do not use or store media in hot humid places or in places where they are exposed to corrosive substances.

### Handling xD-Picture Card

- When storing **xD-Picture Cards**, make sure that they are kept out of the reach of children. An **xD-Picture Card** could be swallowed cause suffocation. If a child swallows an **xD-Picture Card**, seek medical attention or call emergency number right away.
- Do not expose an **xD-Picture Card** to shock. Do not apply pressure, and avoid bending.
- Do not use the **xD-Picture Card** in a hot or humid place.
- Clean the **xD-Picture Card** with a soft dry piece of cloth when dirty.
- When carrying or storing an **xD-Picture Card**, keep it in the special protective case.
- The **xD-Picture Card** will work well for long time, but will sooner or later lose its ability to store and play back images or movies. If this happens replace it with a new **xD-Picture Card**.
- The use of **xD-Picture Cards** is recommended with the FinePix S3 Pro.  
The recording quality cannot be guaranteed when **xD-Picture Cards** other than those manufactured by FUJIFILM are used.

- The **xD-Picture Card** may feel warm when it is removed from the camera after taking pictures. This is normal.
- Do not put labels on the **xD-Picture Card**. Peeling labels can cause the camera not to work properly.

### Using Microdrive

- Do not use hard-pointed pens to write on the Microdrive label.
- Do not peel off the Microdrive label.
- Do not stick additional labels onto a Microdrive.
- When carrying or storing a Microdrive, keep it in the protective case provided.
- When a Microdrive is used, vibration or impacts during image data recording may prevent the image data from being recorded correctly. Put the camera down carefully when placing it on a desk or table, etc.
- Do not use Microdrive in CF+ Type II slots that do not have an eject function.
- Take care when handling Microdrive that have been used for long periods as they may become hot.
- Do not place Microdrives close to strong magnetic fields.
- Keep Microdrive dry.
- Do not apply strong pressure to the Microdrive cover.

### Using Compact Flash

Contact the CompactFlash card manufacturer for information on the CompactFlash functions, operation details and system requirements.

Card types approved for use with the FinePix S3 Pro are listed on the FUJIFILM website.

<http://home.fujifilm.com/products/digital/>

- The CompactFlash card may be hot immediately after being used in the camera and should be handled with care.
- Do not touch the card contact area with your fingers or metal objects.
- Unused CompactFlash cards should be formatted before being used.

### Using media with a PC



- When taking pictures using a media that has been used on a PC, reformat the media using your camera for best quality.
- When formatting a media, a directory (folder) is created. Image data is then recorded in this directory.
- Do not change or delete the directory (folder) or file names on the media because this will make it impossible to use the media in your camera.
- Always use the camera to erase image data on a media.
- To edit image data, copy the image data to the PC and edit the copy.
- Do not copy files other than those that will be used by the camera.

### Specifications

Type	Image memory card for digital cameras ( <b>xD-Picture Card</b> )
Memory type	NAND-type flash memory
Conditions for use	Temperature: 0°C to +40°C (+32°F to +104°F) Humidity: 80% max. (no condensation)
Dimensions	25 mm × 20 mm × 2.2 mm (0.98 in. × 0.79 in. × 0.09 in.) (W × H × D)

# Warning Displays

▶The table below lists the warning messages displayed on the top display panel or in the viewfinder.











Warning Displayed		Explanation	Remedy
Top display panel	Viewfinder		
<b>FE E</b> (blinking)	<b>FE E</b> (blinking)	<ul style="list-style-type: none"> <li>• CPU Nikkor lens other than G-type is not set to its minimum aperture.</li> <li>• Attached flash is not set at TTL Auto Flash in "P" mode.</li> </ul>	<ul style="list-style-type: none"> <li>• Set lens to minimum aperture.</li> <li>• Set the external flash mode to TTL, or set the camera's exposure mode to "S", "A" or "M".</li> </ul>
 (blinking/lit)	—	Batteries have no remaining charge.	Turn the power off and replace batteries with new ones.
<b>F - -</b> (blinking)	<b>F - -</b> (blinking)	Non-CPU lens is attached or lens is not attached.	Attach CPU lens (except IX-Nikkor). With a non-CPU lens, set the exposure mode to "M" and set the aperture with lens' aperture ring.
—	● (blinking)	Autofocus is not possible.	Focus manually.
<b>HI</b> (lit)	<b>HI</b> (lit)	Overexposure warning (subject is too bright).	<ul style="list-style-type: none"> <li>• In "P" mode, use ND filter (If the warning indication remains after performing above remedies in "S" or "A" mode, use ND filter as well).</li> <li>• In "S" mode, select faster shutter speed.</li> <li>• In "A" mode, select smaller aperture (larger f-number).</li> </ul>
<b>Lo</b> (lit)	<b>Lo</b> (lit)	Underexposure warning (subject is too dark.).	<ul style="list-style-type: none"> <li>• In "P" mode, use flash (If the warning indication remains after performing above remedies in "S" or "A" mode, use flash as well).</li> <li>• In "S" mode, select slower shutter speed.</li> <li>• In "A" mode, select larger aperture (smaller f-number).</li> </ul>
—	Electronic analog exposure display (blinking)	Subject brightness is beyond camera's exposure range.	When the subject is too bright, use ND filter and when the subject is too dark, use flash. The electronic analog exposure display remains blinking when the flash is used.
<b>bULb</b> (blinking)	<b>bULb</b> (blinking)	Shutter speed is set to "bULb" in "S" mode.	Cancel the "bULb" or select "M" mode.
Shutter speed indication (blinking)	<b>180</b> (lit)	Shutter speed faster than sync speed is selected in "S" or "M" mode.	Release the shutter as it is to take a flash picture (Shutter speed automatically shifts to 1/180 sec.).
—	 (blinking)	Flash has fired at full output and underexposure may have occurred.	Shoot again after confirming focus distance, aperture or flash shooting distance range.
<b>Err</b> (blinking)	<b>Err</b> (blinking)	Malfunction detected.	Set the Exposure mode dial to "M" and press the shutter button again. If the warning indication remains, or this warning appears frequently, contact you FUJIFILM dealer.
<b>Err</b> (lit)	—	The batteries are low on charge or flat.	Turn the camera off and replace the batteries. Then turn the camera back on and try again.









Warning Displayed		Explanation	Remedy
Top display panel	Viewfinder		
<b>Err</b> (blinking)	—	The batteries are low on charge or the camera mechanism has stopped due to cold and cannot take pictures.	Turn the camera off and replace the batteries. Then turn the camera back on and try again. If this does not resolve the problem, set the Exposure mode dial to "M", set the focusing mode to "M" (Manual focus), press the shutter button and then briefly turn the camera off.

In certain cases, due to static electricity or poorly loaded batteries, the FinePix S3 Pro microcomputer may turn the camera off, even with fresh, properly installed batteries. For the same reason, the operation of camera may not advance properly during either "USB mode" or "IEEE 1394 mode". In each of these cases, to resume operation, simply turn the power off, then turn it on again. Or, remove and reinstall the batteries. When this happens, the camera settings may be initialized. Check the required camera settings before using the camera.



## Warning Displays

► The table below lists the warning that are displayed on the LCD monitor.

Warning Displayed LCD monitor	Explanation	Remedy
	No media is inserted.	Insert a media.
	<ul style="list-style-type: none"> <li>The media is not formatted.</li> <li>The media contact area is soiled.</li> </ul>	<ul style="list-style-type: none"> <li>Format the media on the camera.</li> <li>Wipe the contact area on the media with a soft dry cloth. It may be necessary to format the media. If the message still appears, replace the media.</li> <li>Contact your FUJIFILM dealer.</li> </ul>
	<ul style="list-style-type: none"> <li>The media contact area is soiled.</li> <li>The media is damaged.</li> <li>The media format is incorrect.</li> </ul>	<ul style="list-style-type: none"> <li>Wipe the contact area on the media with a soft dry cloth. It may be necessary to format the media. If the message still appears, replace the media.</li> <li>Contact your FUJIFILM dealer.</li> </ul>
	The media is full.	Erase some images or use a media that has ample free space.
	<ul style="list-style-type: none"> <li>The played back file was not recorded correctly.</li> <li>The media contact area is soiled.</li> </ul>	<ul style="list-style-type: none"> <li>Images cannot be played back.</li> <li>Wipe the contact area on the media with a soft dry cloth. It may be necessary to format the media. If the message still appears, replace the media.</li> <li>Contact your FUJIFILM dealer.</li> </ul>
	The frame number has reached 999-9999.	<ol style="list-style-type: none"> <li>Insert a formatted media into the camera.</li> <li>Set "RENEW" as the FRAME NO. setting in the "SET-UP" menu.</li> <li>Start taking pictures (The frame numbers start from "100-0001").</li> <li>Set "CONT." as the FRAME NO. setting in the "SET-UP" menu.</li> </ol>
	<ul style="list-style-type: none"> <li>The data could not be recorded due to a media error or a connection error between the media and camera.</li> <li>The image cannot be recorded as it is too large to fit in the available space on the media.</li> </ul>	<ul style="list-style-type: none"> <li>Re-insert the media or turn the camera off and then on again. If the message still appears, contact your FUJIFILM dealer.</li> <li>Use a new media.</li> </ul>
	A protected file was encountered.	Protected files cannot be erased. Remove the protection.
	Prints were specified for 1000 or more frames in the DPOF frame settings.	<p>The maximum number of frames for which prints can be specified on the same media is 999.</p> <p>Copy the images for which you want to order prints onto another media and then specify the DPOF settings.</p>
	The camera is not connected to PC or printer.	<ul style="list-style-type: none"> <li>Check that the USB cable is connected correctly.</li> <li>Check that your printer is turned on.</li> </ul>

Warning Displayed LCD monitor	Explanation	Remedy
	Displayed for PictBridge.	<ul style="list-style-type: none"> <li>Check that the printer is not out of paper or out of ink.</li> <li>Turn the printer off briefly and then turn it back on.</li> <li>Refer to the user manual supplied with your printer.</li> </ul>
	Displayed for PictBridge.	Check that the printer is not out of paper or out of ink. Printing automatically restarts when the error is cleared. If the message still appears after checking, press the "MENU/OK" button to restart printing.
	Displayed for PictBridge.	<ul style="list-style-type: none"> <li>Refer to the user manual for the printer being used and check whether the printer supports the JFIF-JPEG or Exif-JPEG image format. If not, the printer cannot print the images.</li> <li>Was the image data photographed using FinePix S3 Pro? You may not be able to print some images photographed on other cameras.</li> </ul>
	Displayed for PictBridge.	This message appears when printing is performed from a FUJIFILM printer that supports PictBridge. Refer to the Owner's Manual for the printer for details.
	An attempt was made to use DPOF printing for a RAW image file.	DPOF printing cannot be used with RAW image files.
 	An attempt was made to trim a 1M image or an image shot using the RAW setting.	The image cannot be trimmed.
	<ul style="list-style-type: none"> <li>An attempt was made to trim an image shot using a camera other than FinePix S3 Pro.</li> <li>The image is damaged.</li> </ul>	The image cannot be trimmed.



► The table below lists the warnings that are displayed on the rear display panel.

Warning Displayed Rear display panel	Explanation	Remedy
 (lit)	The batteries are low on charge.	Have replacement batteries ready.
 (blinking)	The batteries are flat.	Replace the batteries.

# Troubleshooting

► If you think the camera is faulty, check the following once more.

Troubleshooting	Possible causes	Solutions
The camera won't turn on.	<ul style="list-style-type: none"> <li>The batteries are exhausted.</li> <li>The batteries are loaded the wrong way round.</li> <li>The AC power adapter is not connected correctly.</li> </ul>	<ul style="list-style-type: none"> <li>Load fully charged batteries.</li> <li>Reload the batteries correctly.</li> <li>Reconnect the adapter correctly and plug the adapter plug into the mains power outlet.</li> </ul>
Power cuts out during operation.	The batteries are exhausted.	Load fully charged batteries.
Batteries run out quickly.	<ul style="list-style-type: none"> <li>You are using the camera in extremely cold conditions.</li> <li>The battery terminals are soiled.</li> <li>The battery terminals were soiled when the batteries were charged.</li> <li>The batteries were charged after having not been used for a long period.</li> <li>The rechargeable batteries have reached the end of their operating lives.</li> <li>The rechargeable batteries (if used) have become deactivated, or the battery capacity has diminished due to the memory effect.</li> </ul>	<ul style="list-style-type: none"> <li>Put the batteries in your pocket or another warm place to heat them and then load them into the camera just before you take a picture. Note that alkaline batteries cannot be used at very low temperatures.</li> <li>Remove the batteries from the camera and wipe the battery terminals with a clean, dry cloth before reloading the batteries.</li> <li>Wipe the battery terminals with a clean, dry cloth before charging.</li> <li>Due to their nature, the batteries may not be fully charged. Charge and use the batteries several times to restore them to normal operation.</li> <li>Load new fully charged batteries.</li> <li>Use the rechargeable battery discharging function to restore the rechargeable batteries to full capacity.</li> </ul>
No photograph is taken when the shutter button is pressed.	<ul style="list-style-type: none"> <li>The focus is not set in AF-S mode (focus indicator "●" not lit).</li> <li>No media is loaded.</li> <li>The media is full and no further data can be recorded.</li> <li>The media is not formatted.</li> <li>The <b>xD-Picture card</b> contact surface (the gold-colored area) is soiled.</li> <li>The media is damaged.</li> <li>The Auto Power Off function has turned the camera off.</li> <li>The batteries are flat.</li> <li>The camera will not focus.</li> <li>An error occurred.</li> </ul>	<ul style="list-style-type: none"> <li>Use AF lock to set the focus and check that the focus indicator "●" is lit before taking the shot.</li> <li>Load a media.</li> <li>Load a new media or erase some frames.</li> <li>Format the media.</li> <li>Clean the <b>xD-Picture card</b> contact surface (the gold-colored area) with a clean dry cloth.</li> <li>Load a new media.</li> <li>Turn the camera on.</li> <li>Load fully charged batteries.</li> <li>Set the focusing mode to manual (M), focus on the subject manually and take the picture.</li> <li>Refer to the warning displays on P.132-135 and take the appropriate action.</li> </ul>
I can't use the flash to take pictures.	<ul style="list-style-type: none"> <li>The flash is set to Suppressed Flash mode. (The flash is closed.)</li> <li>You pressed the shutter button while the flash was charging.</li> </ul>	<ul style="list-style-type: none"> <li>The flash pops up.</li> <li>Wait until charging is completed before pressing the shutter button.</li> </ul>
The playback image is too dark even though I used the flash.	<ul style="list-style-type: none"> <li>The subject is too far away.</li> <li>Your finger was covering the flash.</li> <li>Something is obstructing the flash.</li> </ul>	<ul style="list-style-type: none"> <li>Move closer to the subject.</li> <li>Hold the camera correctly.</li> <li>Remove the lens hood.</li> </ul>
The playback image is blurred.	<ul style="list-style-type: none"> <li>The lens is dirty.</li> <li>The camera is not focused.</li> <li>The aperture is too small.</li> </ul>	<ul style="list-style-type: none"> <li>Clean the lens.</li> <li>Focus the camera correctly (► P.34).</li> <li>Take the picture with a slightly larger aperture.</li> </ul>

Troubleshooting	Possible causes	Solutions
I cannot format the <b>xD-Picture Card</b> or CF/Microdrive.	The media is damaged.	Use a new media.
I cannot erase all the frames.	The frame is protected.	Remove the frame protection.
Nothing happens when I use the camera switches and dials.	<ul style="list-style-type: none"> <li>Camera malfunction.</li> <li>The batteries are flat.</li> </ul>	<ul style="list-style-type: none"> <li>Remove the power supply (the batteries) and then reload them and try again.</li> <li>Fit new batteries.</li> </ul>
No image appears on the color LCD monitor when I press the "PLAY" button.	<ul style="list-style-type: none"> <li>There is no media loaded.</li> <li>There is no photography data recorded on the media.</li> </ul>	Insert a media that contains some photography data.
There is no image on the TV screen.	<ul style="list-style-type: none"> <li>The camera and TV are not connected correctly.</li> <li>"TV" is selected as the TV input.</li> </ul>	<ul style="list-style-type: none"> <li>Connect the camera and TV correctly.</li> <li>Set the TV input to "VIDEO".</li> </ul>
Film simulation mode cannot be selected.	"D-RANGE" is set to "STANDARD" and AdobeRGB is selected as the color space.	Set "D-RANGE" to "WIDE" and select the sRGB color space.
Can't print with PictBridge.	"  ⇌" is not selected in USB mode in the SET-UP menu.	Select "  ⇌" in USB mode in the SET-UP menu.
The camera was connected to PC when the USB mode was set to "  ⇌".		Perform steps ① to ③ to remove the camera from PC. <ul style="list-style-type: none"> <li>Windows               <ol style="list-style-type: none"> <li>The "New Hardware Found" wizard (or "Scanner and Camera" wizard) appears. If the wizard does not appear, proceed to step ③.</li> <li>Click the [Cancel] button.</li> <li>Disconnect the camera from the PC.</li> </ol> </li> <li>Macintosh               <ol style="list-style-type: none"> <li>The window for locating the driver appears. If the window does not appear, proceed to step ③.</li> <li>Click the [Cancel] button.</li> <li>Disconnect the camera from the Macintosh.</li> </ol> </li> </ul>

# Specifications

System	
<b>Model</b>	Digital camera FinePix S3 Pro
<b>Effective pixels</b>	12.34 million (S-pixel: 6.17 million, R-pixel: 6.17 million) pixels
<b>CCD</b>	Large-format (23.0 × 15.5 mm) Super CCD SR II with primary color filter Total 12.9 megapixels (S-pixels: 6.45 million; R-pixels: 6.45 million)
<b>Storage media</b>	<b>xD-Picture Card</b> (16/32/64/128/256/512 MB) CF card and Microdrive TM (FAT32-compatible) (Compatibility is listed on Fujifilm website: <a href="http://home.fujifilm.com/products/digital/">http://home.fujifilm.com/products/digital/</a> )
<b>File format</b>	DCF-compliant Compressed: Exif Ver.2.21 JPEG, DPOF-compatible Uncompressed: CCD-RAW (RAF) *1
<b>Max. recording resolution</b>	4256 × 2848 (12.1 million)
<b>Number of recorded pixels</b>	4256 × 2848 pixels/3024 × 2016 pixels/2304 × 1536 pixels/1440 × 960 pixels
<b>Lens mount</b>	Nikon F mount (with AF coupling and AF contacts)
<b>Focal length</b>	Approx. 1.5× the nominal focal length of the lens (35mm camera equivalent)
<b>Sensitivity</b>	ISO 100/160/200/400/800/1600 *2
<b>Metering modes</b>	TTL open metering/3D 10-zone Matrix, Center-weighted, Spot
<b>Exposure control</b>	Program AE, Shutter-priority AE, Aperture-priority AE, Manual exposure
<b>Exposure compensation</b>	-3.0 EV to +3.0 EV 1/2 EV step
<b>Shutter</b>	Electronically controlled vertical-travel focal-plane shutter
<b>Shutter speeds</b>	30 to 1/4000 sec, Bulb X contact: Max. 1/180 sec. *3
<b>Continuous shooting *4</b>	Max. 2.5 frames/sec.: Up to max. 12 frames. (D-range: Standard; JPEG mode) Up to max. 7 frames. (D-range: Standard; RAW mode) Max. 1 frame/sec.: Up to max. 6 frames. (D-range: Wide; JPEG mode) Max. 1.4 frames/sec.: Up to max. 3 frames. (D-range: Wide; RAW mode)
<b>Auto bracketing</b>	±0.5 EV, ±1.0 EV, ±1.5 EV, ±2.0 EV,
<b>Focus</b>	Mode: Single-AF servo, Continuous AF servo, Manual AF system: TTL phase difference detection with auxiliary AF flash AF frame selection: Single-area AF, Dynamic AF (Dynamic AF Mode with Closest Subject Priority is available)
<b>White balance</b>	Automatic scene recognition/Presets (Fine, Shade, Fluorescent (Daylight), Fluorescent (Warm White), Fluorescent (Cool White), Incandescent, Custom (2 settings))
<b>Self-timer</b>	20 sec./10 sec./5 sec./2 sec.
<b>Flash</b>	Manual pop-up, D-3D Multi-BL flash control, D Multi-BL flash control, Standard D-TTL flash control Guide No.: 12 (ISO 100-m); Sync. shutter speed: 1/180 sec. or slower
<b>Flash modes</b>	Front Synchro, Slow Synchro, Rear synchro, Red-eye Reduction and Red-eye Reduction Slow Synchro, suppressed flash
<b>Accessory shoe</b>	Standard ISO-type with hot-shoe contact (Safty lock provided)
<b>Synchro contacts</b>	X contacts only, synchronizing speed: 1/180 sec. or slower
<b>Synchro terminal</b>	Equipped with ISO 519 synchro terminal as standard, lock screw provided
<b>Viewfinder</b>	Eye-level pentaprism (coverage: Approx. 93% vertical, approx. 95% horizontal), dioptic adjustment mechanism, viewfinder magnification approx. 0.8x)
<b>LCD monitor</b>	2.0-inch 235,000-pixels low-temperature polysilicon TFT color LCD panel (approx. 100% coverage for playback)
<b>Remote release</b>	Release socket built into the shutter release button 10-pin remote release terminal provided on camera body front
<b>Photography functions</b>	Color space selection, dynamic range selection, film simulation mode selection, framing guideline, frame no. memory, multiple exposure shooting *4, shutter button for vertical shooting, live image
<b>Playback functions</b>	Trimming, Auto Play, multi-frame playback, histogram display, brightness warning display
<b>Other functions</b>	PictBridge compatibility, Exif Print compatibility, PRINT Image Matching II compatibility, language selection (Japanese, English, French, German, Spanish, Italian, Chinese), discharging function

## Standard Number of Available Shots per Media

The number of available shots varies slightly depending on the type of subject. Also, the discrepancy between the actual number of available shots and the standard number grows as the capacity of the media increases.

Number of recorded pixels	RAW CCD-RAW		4256 × 2848		3024 × 2016		2304 × 1536		1440 × 960	
	HIGH		FINE	NORMAL	FINE	NORMAL	FINE	NORMAL	FINE	NORMAL
Quality Mode	D-RANGE WIDE	D-RANGE STANDARD								
	Image File Size	Approx. 25 MB	Approx. 13 MB							
DPC-16 (16 MB)	0	1	3	6	5	10	8	17	14	29
DPC-32 (32 MB)	1	2	6	13	10	20	17	35	30	59
DPC-64 (64 MB)	2	4	13	26	21	42	36	72	61	120
DPC-128 (128 MB)	5	9	26	53	42	84	72	144	122	241
DPC-256 (256 MB)	10	19	53	107	85	169	146	290	245	484
DPC-512 (512 MB)	20	39	107	214	170	339	292	580	491	967
Microdrive (340 MB)	13	27	73	146	116	232	200	396	338	671
Microdrive (1 GB)	41	81	220	437	349	698	597	1173	995	1932

For CCD-RAW files, "H" is displayed as the resolution.

## Input/Output Terminals

<b>Video output</b>	NTSC/PAL selectable
<b>Digital Interface</b>	USB 2.0 (High-speed), IEEE 1394
<b>DC input</b>	Socket for specified AC Power adapter AC-5VX (sold separately)

## Power Supply and Others

<b>Power supply</b>	Use one of the following: <ul style="list-style-type: none"> <li>4× AA-size Ni-MH (Nickel-Metal Hydride) batteries</li> <li>AC Power Adapter AC-5VX (sold separately)</li> </ul>
<b>Dimensions and weight (W × H × D)</b>	Camera body dimensions: 147.8 mm × 135.3 mm × 78.5 mm/5.8 in. × 5.3 in. × 3.1 in. (excluding lens and attachments) Camera body weight: 815 g/28.7 oz (excluding lens, batteries and recording media) Weight when shooting: Dependent on the lens used
<b>Operating conditions</b>	Temperature: 0°C to +40°C. (+32°F to +104°F) *Note that the range for Microdrive is +5°C to +40°C (+41°F to +104°F). Humidity: 80% or less (no condensation)

## Guide to the number of available frames for battery operation

Battery Type	With LCD monitor ON
Ni-MH batteries 2300 mAh	Approx. 400 frames

According to the CIPA (Camera & Imaging Products Association) standard procedure for measuring digital still camera battery consumption (extract):  
When using Ni-MH batteries, use the batteries supplied with the camera. The storage media should be xD-Picture Card.  
Shots taken at 23°C, one shot every 30 seconds using a 50mm AF1.4D lens with 1-time AF operation, full flash for every other shot, the camera turned off/on every 10 shots and auxiliary AF lighting turned off.  
\* Note: Because the number of available shots varies depending on the level of charge in Ni-MH batteries, the figures shown here for the number of available shots using batteries are not guaranteed. The number of available shots will also decline at low temperatures.

<b>Accessories</b>	See P.8
<b>Optional accessories</b>	See P.122-123

- \*1: CCD-RAW is a format specific to the FinePix S3 Pro. The enclosed "FinePixViewer" software or the optional Hyper-Utility software "HS-V2 Ver. 3.0" is required to interpret the images.
- \*2: Images shot in high-sensitivity photography (ISO 400 or higher) may appear coarse and may also be affected by noise such as white dots.
- \*3: Images shot with long exposures (about 4 second or longer) may appear coarse and may also be affected by noise such as white dots.
- \*4: See P.50 for the max. no. of consecutive shots and the shooting intervals for multiple exposure shooting.

\* These specifications and performance data are subject to change without notice. FUJIFILM accepts no liability whatsoever for errors or omissions in this manual.  
\* The color LCD monitor on your digital camera is manufactured using advanced high-precision technology. Even so, up to 0.01% of the pixels may fail to light or may remain permanently lit. This phenomenon will not appear on the recorded image.  
\* The operation error may be caused in a digital camera by the strong radio interference (i. e. electric fields, static electricity, line noise, etc.).

## Explanation of Terms

### Adobe RGB (1998)

A color space introduced as the working color space for Adobe Photoshop 5.0. AdobeRGB encompasses almost all the colors reproduced by CMYK printers and is intended primarily for printing applications. It was introduced as "SMPTE-240E" in the RGB settings in Adobe Photoshop 5.0 and as "Adobe RGB (1998)" in the profile settings from version 6.0 onwards.

### CCD-RAW

This is the image data prior to signal processing (the reconstruction of the data read in from the CCD as an image). Because the signal processing is performed on the computer, high levels of control are possible.

\* To reconstruct images, FinePixViewer (on the enclosed CD-ROM) or the Hyper Utility (optional) must be installed on your computer.

### Color space

Refers to the range of colors, expressed as two-dimensional or three-dimensional numerical values, that can be reproduced by devices such as cameras, monitors and printers. The sRGB and AdobeRGB color spaces are each shown as an xy color chart (a coordinate color space in which colors are represented in two dimensions with no brightness value). The range of colors that can be expressed by a particular color space is indicated by a triangle imposed on the xy color chart. Colors become brighter as they approach the outer edge of the xy color chart. This color representation method is capable of showing all the actual colors.

### Color Temperature

Low-temperature light sources, such as a candle flame, are strongly red, while high-temperature light sources, such as a gas burner flame, are strongly blue. The color of the light for these temperatures is expressed as a color temperature (K = Kelvin). The light of the sun at midday in a completely clear sky is taken to be 5500K.

### EV

A number that denotes Exposure Value. The EV is determined by the brightness of the subject and sensitivity (speed) of the film or CCD. The number is larger for bright subjects and smaller for dark subjects. As the brightness of the subject changes, a digital camera maintains the amount of light hitting the CCD at a constant level by adjusting the aperture and shutter speed.

When the amount of light striking the CCD doubles, the EV increases by 1. Likewise, when the light is halved, the EV decreases by 1.

### JPEG

Joint Photographic Experts Group

A file format used for compressing and saving color images. The higher the compression rate, the greater the loss of quality in the decompressed (restored) image.

### White Balance

Whatever the kind of the light, the human eye adapts to it so that a white object still looks white. On the other hand, devices such as digital cameras see a white subject as white by first adjusting the color balance to suit the color of the ambient light around the subject. This adjustment is called matching the white balance.



Exif Print Format is a newly revised digital camera file format that contains a variety of shooting information for optimal printing.

## Safety Notes

- Make sure that you use your FinePix S3 Pro camera correctly, read these Safety Notes and your Owner's Manual carefully beforehand.
- After reading these Safety Notes, store them in a safe place.

### About the Icons

The icons shown below are used in this document to indicate the severity of the injury or damage that can result if the information indicated by the icon is ignored and the product is used incorrectly as a result.





















	<b>WARNING</b>	This icon indicates that death or serious injury can result if the information is ignored.
	<b>CAUTION</b>	This icon indicates that personal injury or material damage can result if the information is ignored.

The icons shown below are used to indicate the nature of the information which is to be observed.

- Triangular icons tell you that this information requires attention ("important").
- Circular icons with a diagonal bar tell you that the action indicated is prohibited ("Prohibited").
- Filled circles with an exclamation mark tell you an action that must be performed ("Required").

<b>WARNING</b>	
<p><b>If a problem arises, turn the camera off, remove the batteries, disconnect and unplug the AC power adapter.</b></p> <p>Continued use of the camera when it is emitting smoke, is emitting any unusual odor, or is in any other abnormal state can cause a fire or electric shock.</p> <ul style="list-style-type: none"> <li>• Contact your FUJIFILM dealer.</li> </ul>	 Unplug from power socket.
<p><b>Do not allow water or foreign objects to enter the camera.</b></p> <p>If water or foreign objects get inside the camera, turn the camera off, remove the batteries and disconnect and unplug the AC power adapter. Continued use of the camera can cause a fire or electric shock.</p> <ul style="list-style-type: none"> <li>• Contact your FUJIFILM dealer.</li> </ul>	 Do not use in the bathroom or shower.
<p><b>Do not use the camera in the bathroom or shower.</b></p> <p>This can cause a fire or electric shock.</p>	 Do not use in the bathroom or shower.
<p><b>Never attempt to change or take apart the camera. (Never open the casing.)</b></p> <p><b>Do not use the camera when it has been dropped or the casing is damaged.</b></p> <p>This can cause a fire or electric shock.</p> <ul style="list-style-type: none"> <li>• Contact your FUJIFILM dealer.</li> </ul>	 Do not disassemble.
<p><b>Do not change, heat or unduly twist or pull the connection cord and do not place heavy objects on the connection cord.</b></p> <p>These actions could damage the cord and cause a fire or electric shock.</p> <ul style="list-style-type: none"> <li>• If the cord is damaged, contact your FUJIFILM dealer.</li> </ul>	
<p><b>Do not place the camera on an unstable surface.</b></p> <p>This can cause the camera to fall or tip over and cause injury.</p>	
<p><b>Never attempt to take pictures while in motion.</b></p> <p>Do not use the camera while you are walking or driving a vehicle. This can result in you falling down or being involved in a traffic accident.</p>	
<p><b>Do not touch any metal parts of the camera during a thunderstorm.</b></p> <p>This can cause an electric shock due to induced current from the lightning discharge.</p>	
<p><b>Do not use the batteries except as specified.</b></p> <p>Load the batteries with the ⊕ and ⊖ marks.</p>	

## Safety Notes

 <b>WARNING</b>	
<p>Do not heat, charge or take apart the batteries. Do not drop or subject the batteries to impacts. Do not attempt to recharge lithium or alkaline batteries. Do not store the batteries with metallic products. Do not use chargers other than the specified model to charge the batteries.</p> <p>Any of these actions can cause the batteries to burst or leak and cause fire or injury as a result.</p>	
<p>Use only the batteries or AC power adapters specified for use with this camera. Do not use voltages other than the power supply voltage shown.</p> <p>The use of other power sources can cause a fire.</p>	
<p>If the battery leaks and fluid gets in contact with your eyes, skin or clothing. Flush the affected area with clean water and seek medical attention or call emergency number right away.</p>	
<p>Do not use the charger to charge batteries other than those specified here.</p> <p>The charger is designed for Fujifilm HR-AA Ni-MH batteries. Using the charger to charge conventional batteries or other types of rechargeable batteries can cause the battery to leak fluid, overheat or burst.</p>	
<p>When discarding or storing batteries, cover the battery terminals with insulation tape.</p> <ul style="list-style-type: none"> <li>Contact with other metallic objects or batteries could cause the batteries to ignite or burst.</li> </ul>	
<p>Keep xD-Picture Cards out of the reach of small children.</p> <p>Because xD-Picture Cards are small, they can be swallowed by children. Be sure to store xD-Picture Cards out of the reach of small children. If a child swallows an xD-Picture Card, seek medical attention or call emergency number.</p>	
 <b>CAUTION</b>	
<p>Do not use this camera in locations affected by oil fumes, steam, humidity or dust. This can cause a fire or electric shock.</p>	
<p>Do not leave this camera in places subject to extremely high temperatures. Do not leave the camera in locations such as a sealed vehicle or in direct sunlight. This can cause a fire.</p>	
<p>Keep out of the reach of small children. This product could cause injury in the hands of a child.</p>	
<p>Do not place heavy objects on the camera. This can cause the heavy object to tip over or fall and cause injury.</p>	
<p>Do not move the camera while the AC power adapter is still connected. Do not pull on the connection cord to disconnect the AC power adapter. This can damage the power cord or cables and cause a fire or electric shock.</p>	
<p>Do not use the AC power adapter when the plug is damaged or the plug socket connection is loose. This could cause a fire or electric shock.</p>	
<p>Do not cover or wrap the camera or the AC power adapter in a cloth or blanket. This can cause heat to build up and distort the casing or cause a fire.</p>	
<p>When you are cleaning the camera or you do not plan to use the camera for an extended period, remove the batteries and disconnect and unplug the AC power adapter. Failure to do so can cause a fire or electric shock.</p>	
<p>When charging ends, unplug the charger from the power socket. Leaving the charger plugged into the power socket can cause a fire.</p>	
<p>Using a flash too close to a person's may temporarily affect the eyesight. Take particular care when taking pictures of children.</p>	
<p>When an xD-Picture Card is removed, the card could come out of the slot too quickly. Use your finger to hold it and gently release the card.</p>	
<p>Request regular internal testing and cleaning for your camera. Build-up of dust in your camera can cause a fire or electric shock.</p> <ul style="list-style-type: none"> <li>Contact your FUJIFILM dealer to request internal cleaning every 2 years. Please note this is not a free of charge service.</li> </ul>	





---

**FUJI PHOTO FILM CO., LTD.**

26-30, Nishiazabu 2-chome, Minato-ku, Tokyo 106-8620, Japan

<http://home.fujifilm.com/products/digital/>

Printed in Japan

Printed on recycled paper.

FGS-406110-FG