

ДОМ МЕЧТЫ

ИНСТРУКЦИЯ

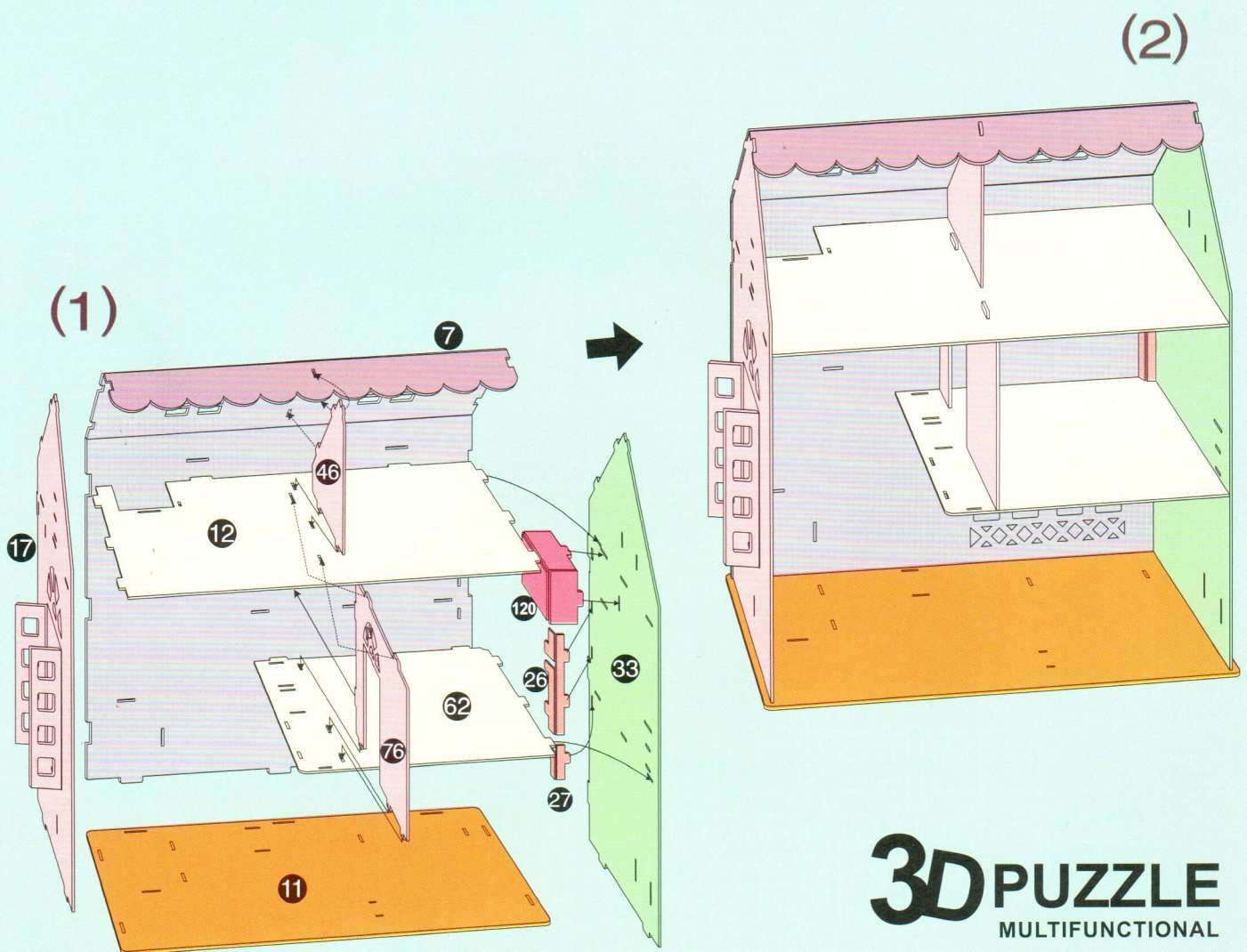

3D PUZZLE
MULTIFUNCTIONAL

160
ДЕТАЛЕЙ

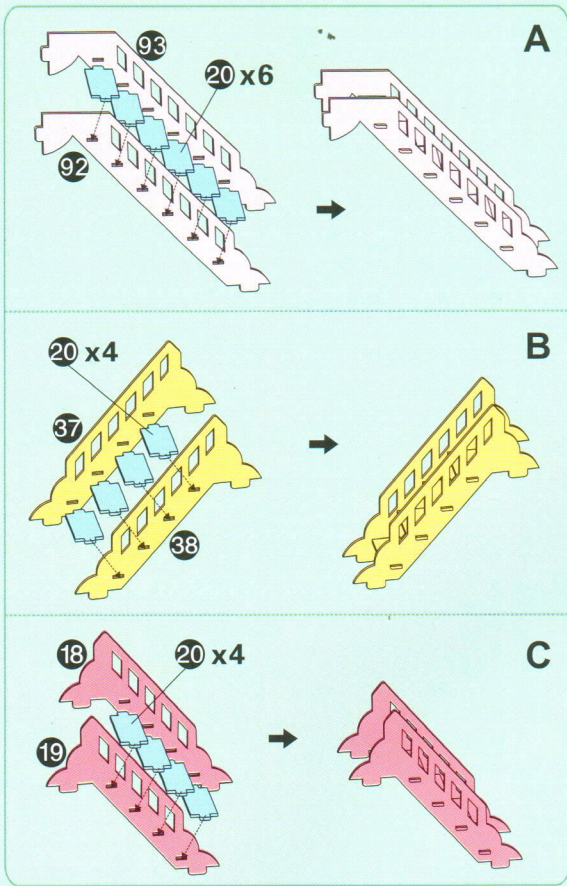

(3)

(4)

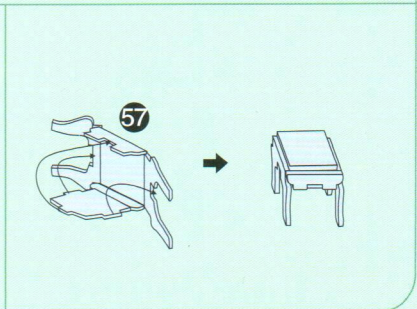
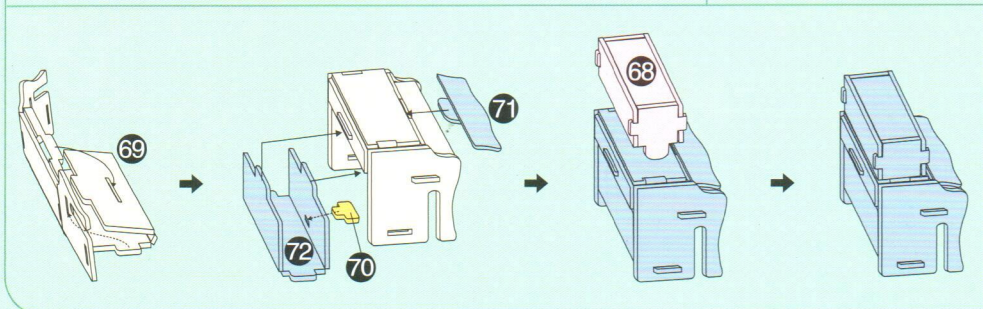
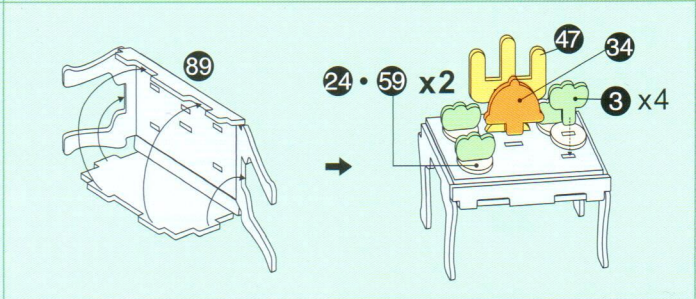
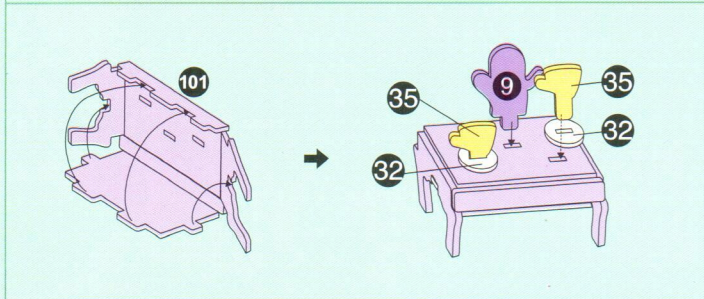
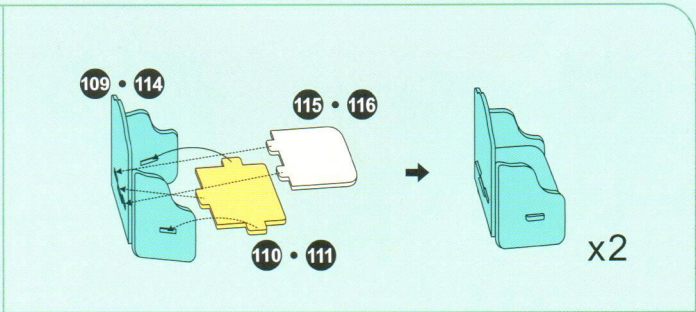
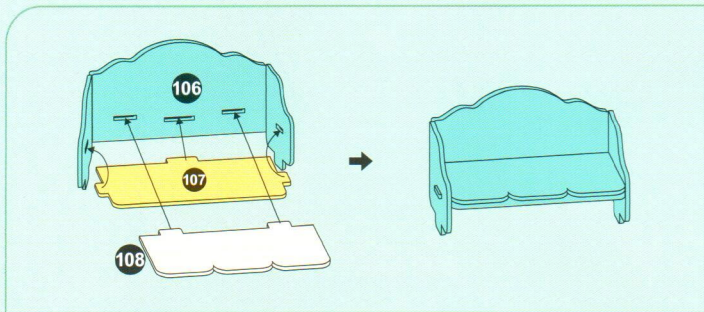
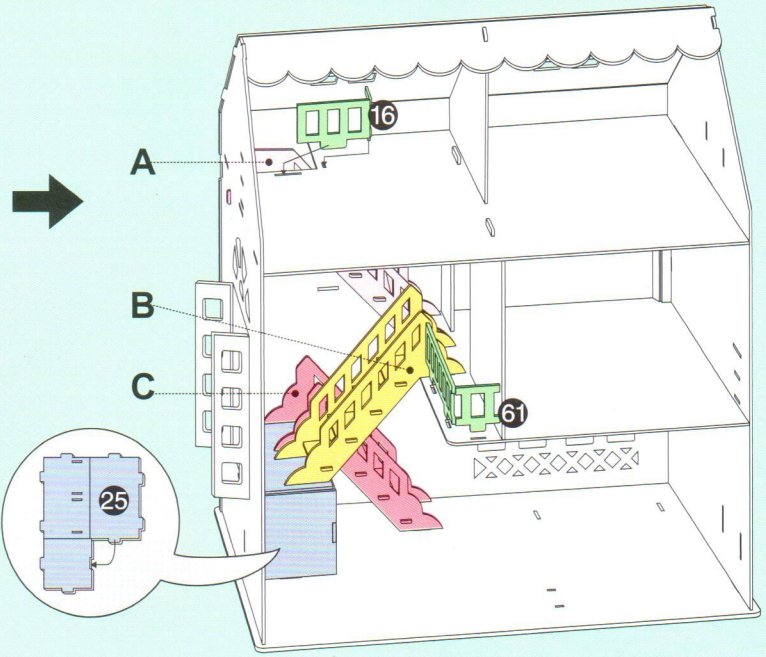

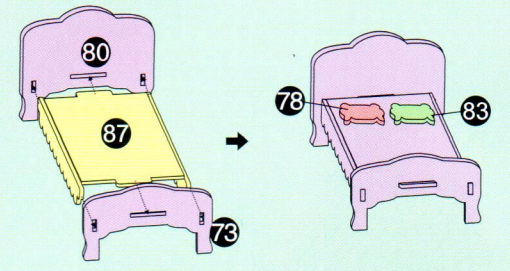
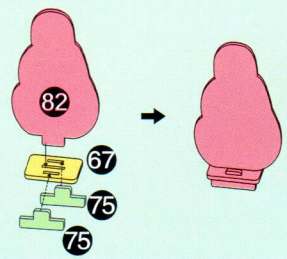
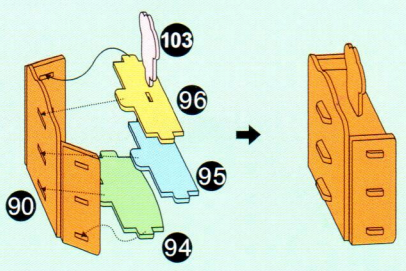
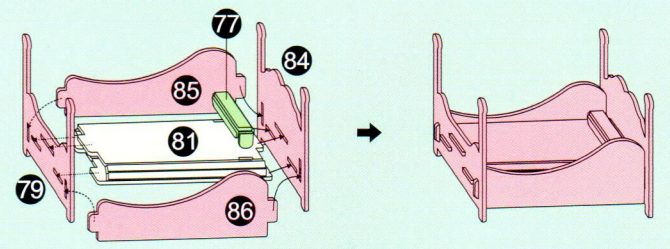
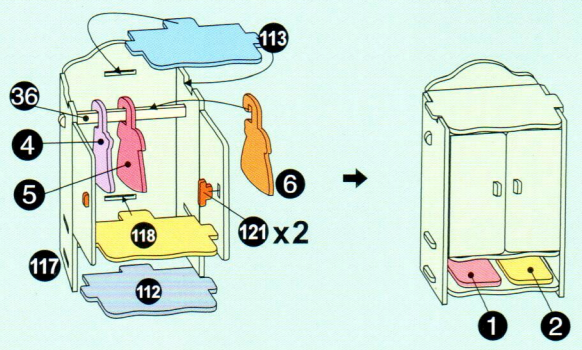
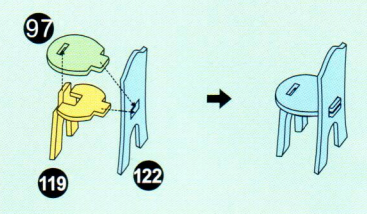
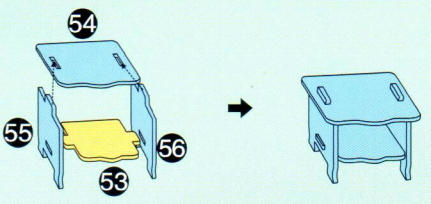
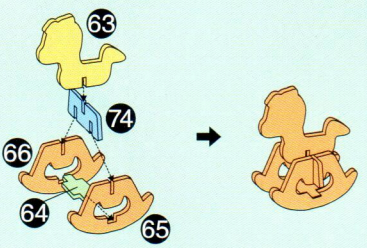
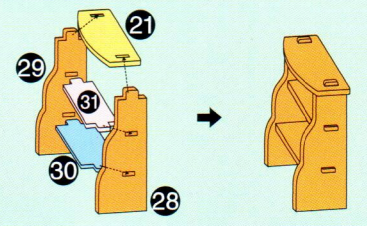
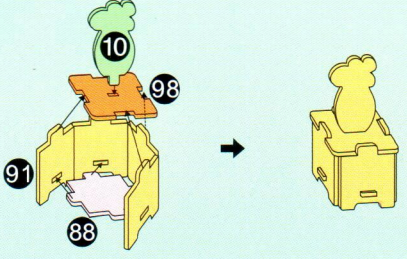
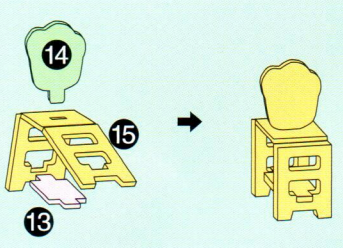
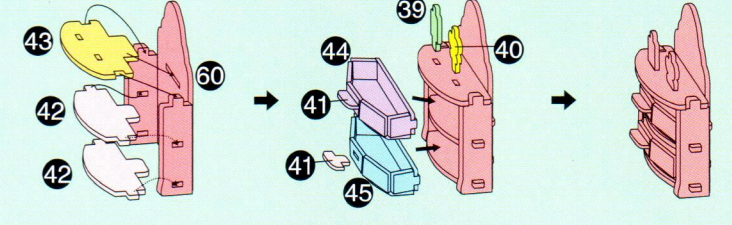
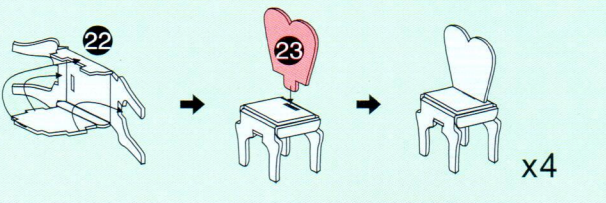
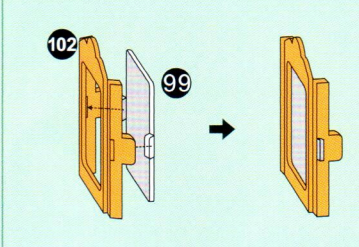
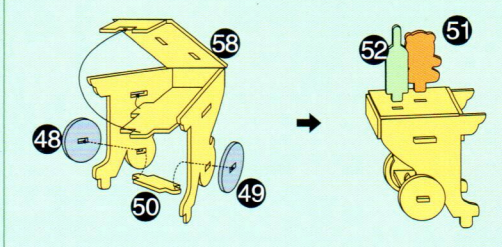
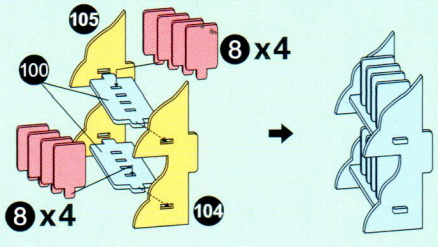

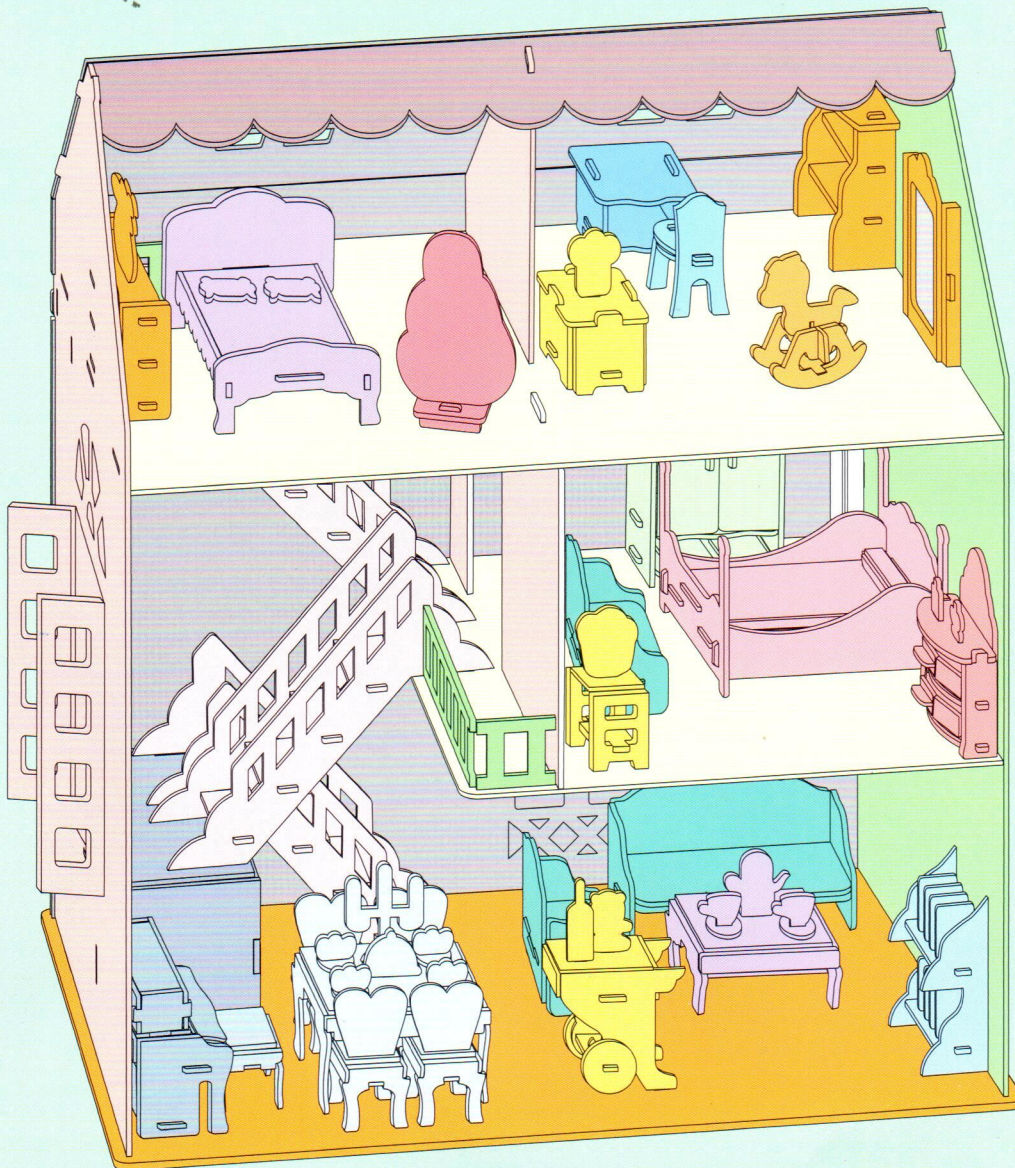

Caution

Please put the small leftover pieces into the garbage after finishing assembly. And be careful not to let your children eat or put our products or the packaging into their nose or ear.

Instructions

Refer to the photograph on the package and join the pieces by matching the drawings on the above. After popping out the pieces, you can punch out the interlocking holes with the corners of the foam boards.

ВНИМАНИЕ

ПОСЛЕ ЗАВЕРШЕНИЯ ПРОЦЕССА СБОРКИ ВЫБРОСЬТЕ ВСЕ ОСТАВШИЕСЯ НЕИСПОЛЬЗОВАННЫЕ КУСОЧКИ МАТЕРИАЛА. СЛЕДИТЕ ЗА ТЕМ, ЧТОБЫ ДЕТИ НЕ ПРОГЛОТИЛИ ИХ И НЕ ЗАСУНУЛИ В НОС ИЛИ УШИ.

ИНСТРУКЦИЯ ПО СБОРКЕ

ПОСМОТРИТЕ НА ФОТОГРАФИЮ НА УПАКОВКЕ И СОБЕРИТЕ ДЕТАЛИ, КАК ПОКАЗАНО НА РИСУНКЕ ВЫШЕ. ПОСЛЕ СБОРКИ МОДЕЛИ ОКОНЧАТЕЛЬНО СКОРРЕКТИРУЙТЕ ПОЛОЖЕНИЕ ДЕТАЛЕЙ В ПАЗАХ.

Anleitung

Drücken Sie die Einzelteile gemäß der Nummern auf der Anleitung aus den Stanzbögen heraus und stecken Sie sie wie beschrieben zusammen. Orientieren Sie sich hierbei auch an dem Foto auf der Verpackung. Benutzen Sie einen Stift oder einen anderen dünnen Gegenstand, um kleine Stanzungen herauszudrücken.

注意

※組み立てを終えた後は、残った断片をゴミ箱に必ず捨ててください。

※小さなお子様の口・鼻・耳に取り除いた小さな部品が入らないよう十分注意してください。

組み立て方法

①ケース上の写真を良く見てください。

②1枚ずつ順番にタワー本体(抜き線部分)を抜いてください。

③上記①の写真を参考にA・B・Cを作成してください。

④ケース内の図面を参考にして、A・B・Cと断片を接合してください。

说明:

参照上面的拼装说明图,从纸板上取出部件,然后将各个部件进行连接拼装。

注意:

产品组装完成后,请把剩下的材料装回包装袋里;慎防被您的小孩拿去食用或放进鼻子、耳朵里。

Designed & Manufactured By:

CubicFun Toys Industrial Co.,Ltd

Add:No1 Shaoshan Rd,LonghuZhuJin Ind.District,Shantou,China

www.cubicfun.com