

User's Manual

DJM-4

3-CHANNEL VCA -CONTROLLED
DJ MIXER WITH BEAT COUNTER

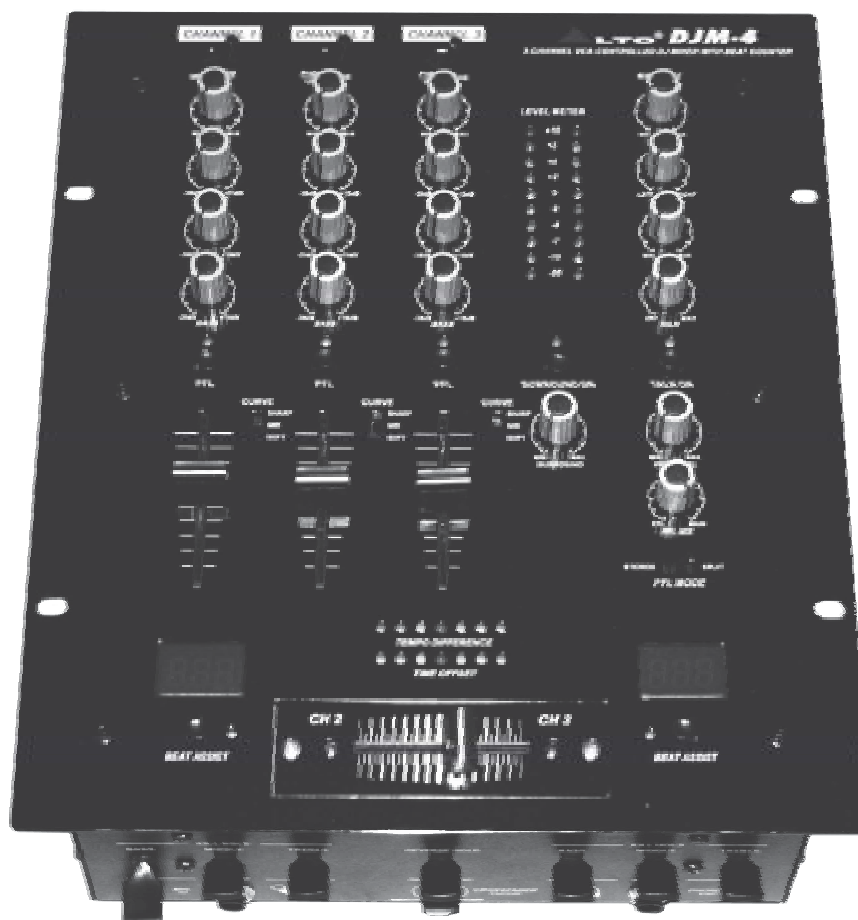

www.altoproaudio.com
Version 2.3 September 2005

— English —

SAFETY RELATED SYMBOLS



This symbol, wherever used, alerts you to the presence of un-insulated and dangerous voltages within the product enclosure. These are voltages that may be sufficient to constitute the risk of electric shock or death.



This symbol, wherever used, alerts you to important operating and maintenance instructions. Please read.



Protective Ground Terminal



AC mains (Alternating Current)



Hazardous Live Terminal

ON: Denotes the product is turned on.

OFF: Denotes the product is turned off.

WARNING

Describes precautions that should be observed to prevent the possibility of death or injury to the user.

CAUTION

Describes precautions that should be observed to prevent damage to the product.



Disposing of this product should not be placed in municipal waste and should be Separate collection.

WARNING

• Power Supply

Ensure that the mains source voltage (AC outlet) matches the voltage rating of the product. Failure to do so could result in damage to the product and possibly the user.

Unplug the product before electrical storms occur and when unused for long periods of time to reduce the risk of electric shock or fire.

• External Connection

Always use proper ready-made insulated mains cabling (power cord). Failure to do so could result in shock/death or fire. If in doubt, seek advice from a registered electrician.

• Do Not Remove Any Covers

Within the product are areas where high voltages may present. To reduce the risk of electric shock do not remove any covers unless the AC mains power cord is removed.

Covers should be removed by qualified service personnel only.

No user serviceable parts inside.

• Fuse

To prevent fire and damage to the product, use only the recommended fuse type as indicated in this manual. Do not short-circuit the fuse holder. Before replacing the fuse, make sure that the product is OFF and disconnected from the AC outlet.

• Protective Ground

Before turning the product ON, make sure that it is connected to Ground. This is to prevent the risk of electric shock.

Never cut internal or external Ground wires. Likewise, never remove Ground wiring from the Protective Ground Terminal.

• Operating Conditions

Always install in accordance with the manufacturer's instructions.

To avoid the risk of electric shock and damage, do not subject this product to any liquid/rain or moisture. Do not use this product when in close proximity to water.

Do not install this product near any direct heat source. Do not block areas of ventilation. Failure to do so could result in fire.

Keep product away from naked flames.

IMPORTANT SAFETY INSTRUCTIONS

Read these instructions

Follow all instructions

Keep these instructions. Do not discard.

Heed all warnings.

Only use attachments/accessories specified by the manufacturer.

• Power Cord and Plug

Do not tamper with the power cord or plug. These are designed for your safety.

Do not remove Ground connections!

If the plug does not fit your AC outlet seek advice from a qualified electrician.

Protect the power cord and plug from any physical stress to avoid risk of electric shock.

Do not place heavy objects on the power cord. This could cause electric shock or fire.

• Cleaning

When required, either blow off dust from the product or use a dry cloth.

Do not use any solvents such as Benzol or Alcohol. For safety, keep product clean and free from dust.

• Servicing

Refer all servicing to qualified service personnel only.

Do not perform any servicing other than those instructions contained within the User's Manual.

PREFACE

Dear Customer:

Thank you for choosing the ▲LTO DJM-4 3-Channel VCA-CONTROLLED DJ Mixer with Beat Counter, which is the result of our ▲LTO AUDIO TEAM's endeavours.

For the ▲LTO AUDIO TEAM, music and audio is more than a profession, it is a passion and an obsession!

We have, in fact, been designing professional audio products for a number of years in cooperation with many of the world's major brands.

The ▲LTO line represents unparalleled analogue and digital products made by musicians, for musicians. With our design centres in Italy, the Netherlands, and the United Kingdom we provide you with world-class designs, while our software development teams continue to develop an impressive range of audio specific algorithms.

By purchasing our ▲LTO products you become the most important member of our ▲LTO AUDIO TEAM. We would like to share with you our passion for what we design and invite you to make suggestions, which will aid us in developing future products for you. We guarantee you our commitment for quality, continual research and development, and of course the best prices.

The ▲LTO DJM-4 is an extremely flexible 3-Channel VCA-CONTROLLED DJ Mixer with Beat Counter, configured with three input channels. Each channel is equipped with a variety of key features including 3 phone/line inputs, 1 microphone input, intelligent dual auto beats per minute counter with time and beat sync. display, treble, middle and bass EQ on each channel, crossfader curve etc..

We would like to thank all the people who made the ▲LTO DJM-4 3-Channel VCA-CONTROLLED DJ Mixer with Beat Counter possible, especially to our designers and ▲LTO staff. It is their passion for music and professional audio that has made it possible for us to offer you, our most important team member, our continued support.

Thank you very much

▲LTO AUDIO TEAM

TABLE OF CONTENTS

1. INTRODUCTION.....	4
2. FEATURE LIST.....	4
3. CONTROL ELEMENTS.....	5
3.1 The Top Cover	
3.1.1 The CHANNEL Section	
3.1.2 The MAIN OUT Section	
3.1.3 The PFL Section	
3.1.4 The LEVER METER Section	
3.1.5 The BPM Section	
3.2 The Front Panel	
3.2.1 The KILL Function	
3.2.2 The REVERSE Function	
3.2.3 MIC IN Jack	
3.2.4 CROSSFADER CURVE Control	
3.2.5 The PHONE OUT Jack	
3.3 The Rear Panel	
3.3.1 AC Inlet and Fuse Holder	
3.3.2 POWER Switch	
3.3.3 GND Screw	
3.3.4 The MAIN OUT	
3.3.5 EFFECTS Send and Return	
3.3.6 INPUT	
4. TECHNICAL SPECIFICATIONS.....	11
5. SYSTEM BLOCK DIAGRAM.....	12
6. WARRANTY.....	13

1. INTRODUCTION

What a great DJ mixer you have just bought. Your DJM 4 is packed with features such as digital beat counter, 3 turntable input, 3 line input, microphone input, 3 bands equaliser and replaceable cross-fader just to mention a few. Your DJM 4 is VCA Controlled and it is very easy to operate. Please go through this Manual carefully and you will get the best out of your DJM 4.

2. FEATURE LIST

- 8 Inputs: 3 phono and 3 line inputs, 1 microphone input, 1 return
- Main outputs through RCA connectors, headphone output via 1/4" TRS jack
- Gain Control and bass, middle, treble equaliser on each channel
- Digital BPM (beats per minute) Counter
- TALK control
- SURROUND control
- PFL switch
- Crossfader curve Control
- Accurate Led Meter (10-segment)
- VCA assisted Faders

3. CONTROL ELEMENTS

3.1 The Top Cover

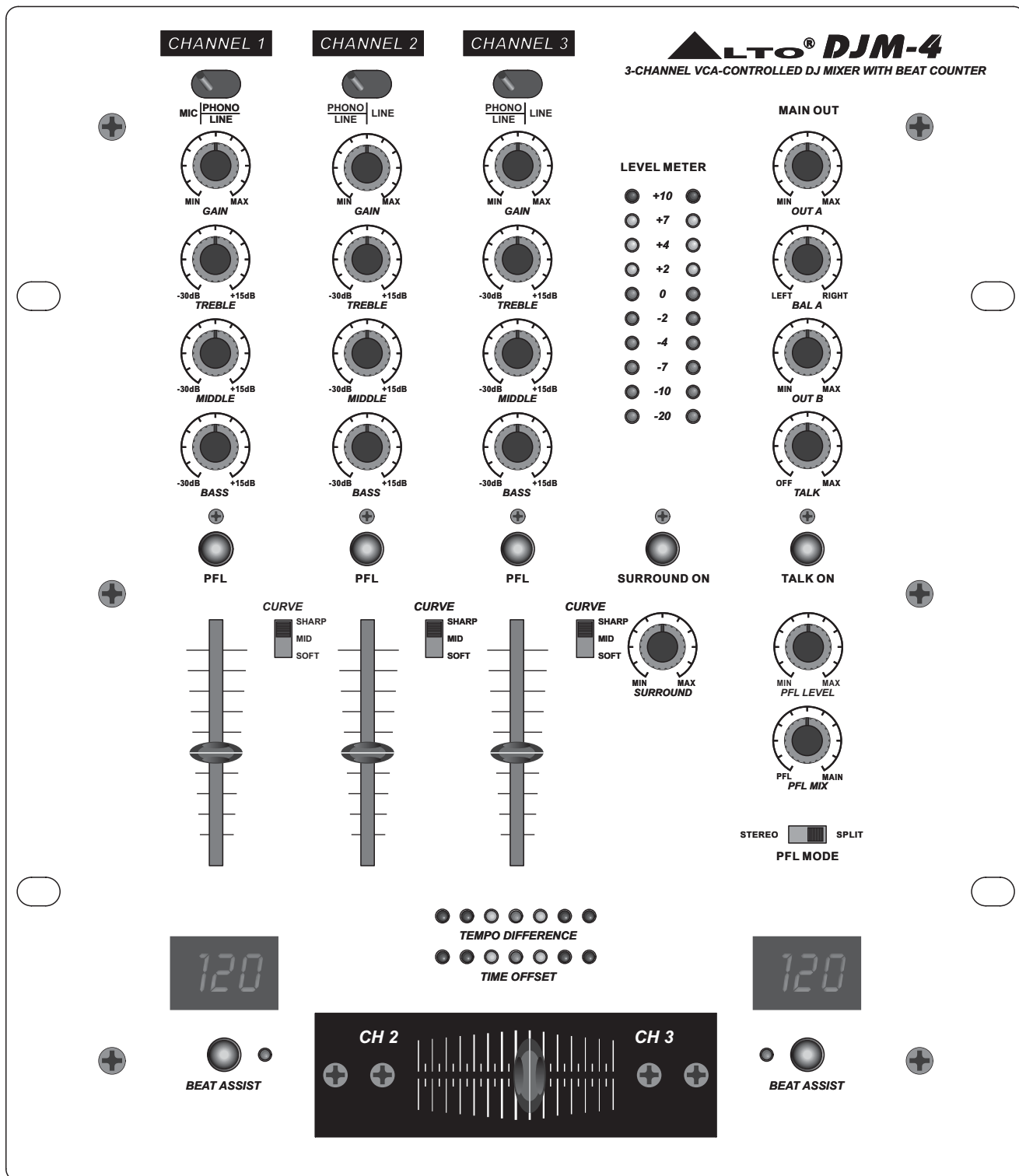

3.1.1 The CHANNEL Section

- The MIC to PHONO-LINE switch 1

The channel 1 is equipped with the MIC to PHONO-LINE switch. This switch is used to select microphone input and phono/line Input. When it is in the right position, you can use the PHONO/LINE switch on the rear panel to input the line signal to the phono input connector.

- PHONO-LINE to LINE switch 2

This switch is available on input channel 2 and channel 3. You should use the LINE position for all high level audio signals such as CD Players, DAT, MD, etc.. You should use the PHONO-LINE position to connect the turntables making sure that the PHONO-LINE switch on the rear panel is on PHONO position. With this switch (the one on the rear panel) on LINE position, the Input Channel will accept a high level audio signal.

- The GAIN control 3

Via this knob you will adjust the input level. Do not turn this control too much clockwise or you will overload the channel and do not turn it too much counterclockwise or you will generate background hiss.

- The EQUALISER control

Each Input Channel is provided with 3 bands equaliser: Treble (4), Middle (5) and Bass (6) and you can adjust the gain range of each from -30dB to +15dB.

- The PROGRAM Fader 7

There is a Program Fader available on each input channel. For optimum performance and operation the 3 Faders are VCA (Voltage Control Amplifier) controlled. These Faders adjust the overall level of the input channels.

- The CURVE control 8

Each input channel includes a 3-position switch denominated CURVE.

If you set the CURVE switch on SHARP position the level will be changed quite quickly by the PROGRAM Fader even if you move the Fader slowly.

If you set the CURVE switch in SOFT position, the level will be changed much more slowly by the PROGRAM Fader even if you move the Fader quickly.

If you set the CURVE switch in MID position you will combine the SHARP and SOFT configuration.

- The PFL button 9

This button is used to route the input signal of corresponding channel to PFL section via pressing it.

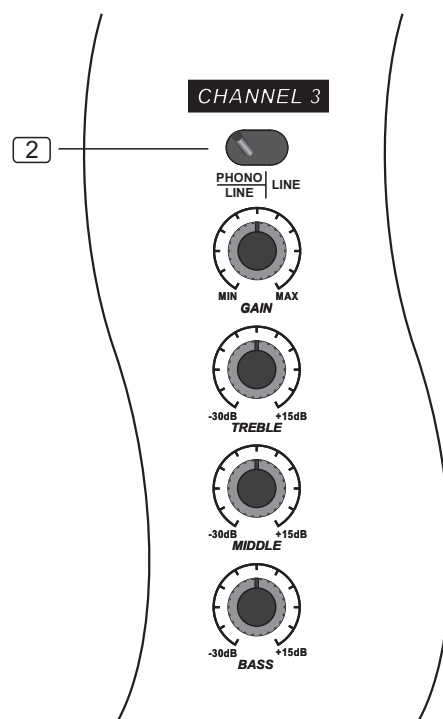
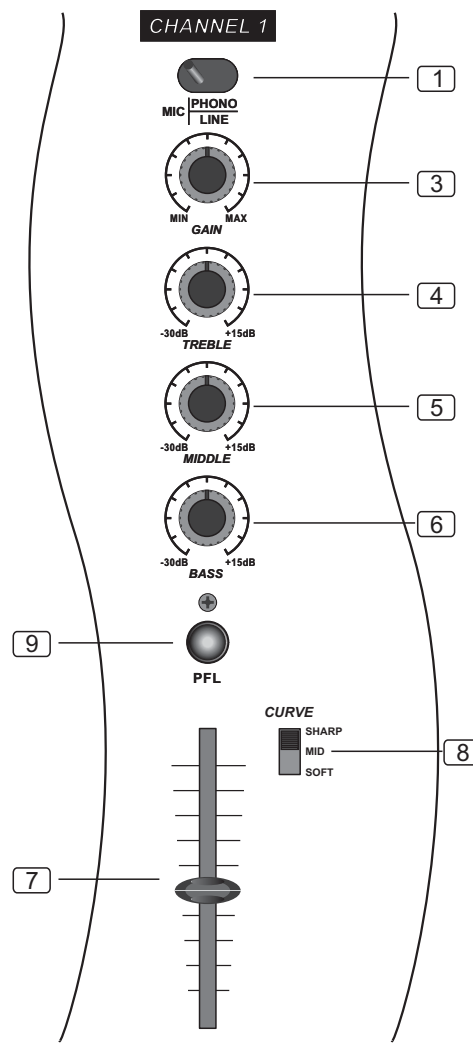

3.1.2 The MAIN OUT Section

- The OUT A control 10

The OUT A control is used to adjust the main level of the AMP output on rear panel.

- The BAL A control 11

The BAL A control is used to adjust the stereo balance of the AMP output on rear panel.

- The OUT B control 12

The OUT B control is used to adjust the main level of the BOOTH output on rear panel.

- The TALK control 13

When you speak through a connected microphone, the volume of the reproduced music will be automatically reduced by the mixer for better intelligibility of your voice. You can determine yourself how much the volume of the music will be reduced via this control. You can turn off the TALK function via this button (14).

- The SURROUND control 15

DJ Mixers are often used in quite inappropriate venues and the positioning of the loudspeakers is not always optimal.

The Surround Control allow you to get a better transparency and stereo image and will contribute to "clean" you mix.

-The SURROUND ON switch 16

You can turn off the Surround function via this switch. You can also run fast A/B comparison (with surround/without surround) via this switch.

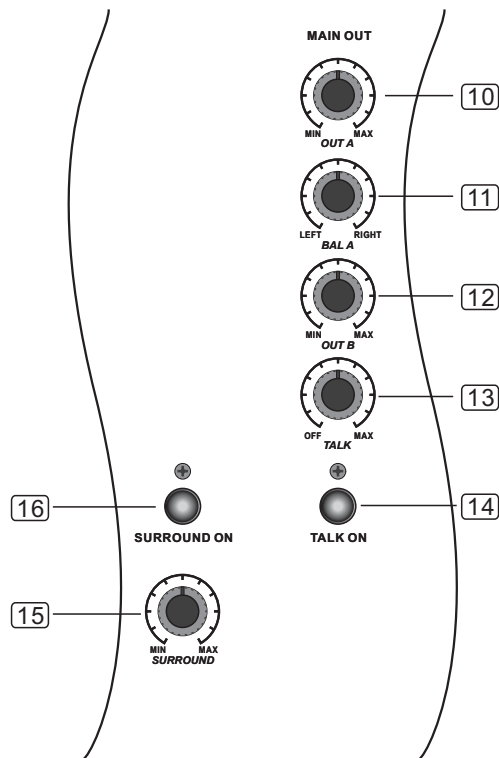

3.1.3 The PFL Section

When you connect a headphone to your DJM 4 you have the chance of pre-listen the audio signal before the signal reach the Main output.

-LEVEL control 17

This knob will adjust the level of the headphone signal.

-The PFL MIX control 18

When set the switch mode (19) in STEREO position, you can fade between PFL and MAIN output.

-MODE switch 19

This is a 2-position switch. When the switch is in STEREO position, the PFL MIX control will fade between PFL signal and MAIN output. When the switch is in SPLIT position, the PFL MIX control has no influence on the PFL signal.

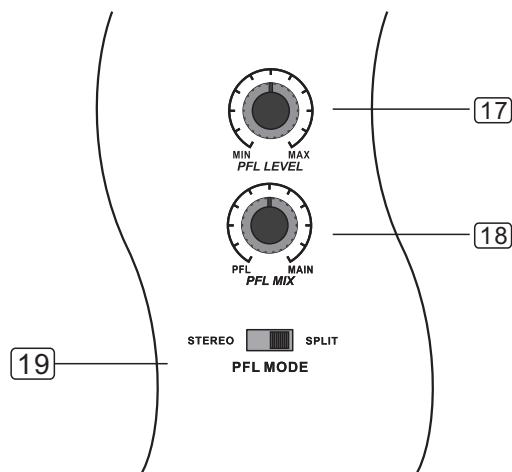

3.1.4 The LEVEL METER Section

-LEVEL METER 20

This 10 segments LED's Meter will monitor the output level.

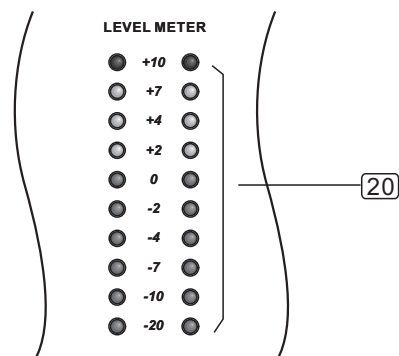

3.1.5 The BPM Section

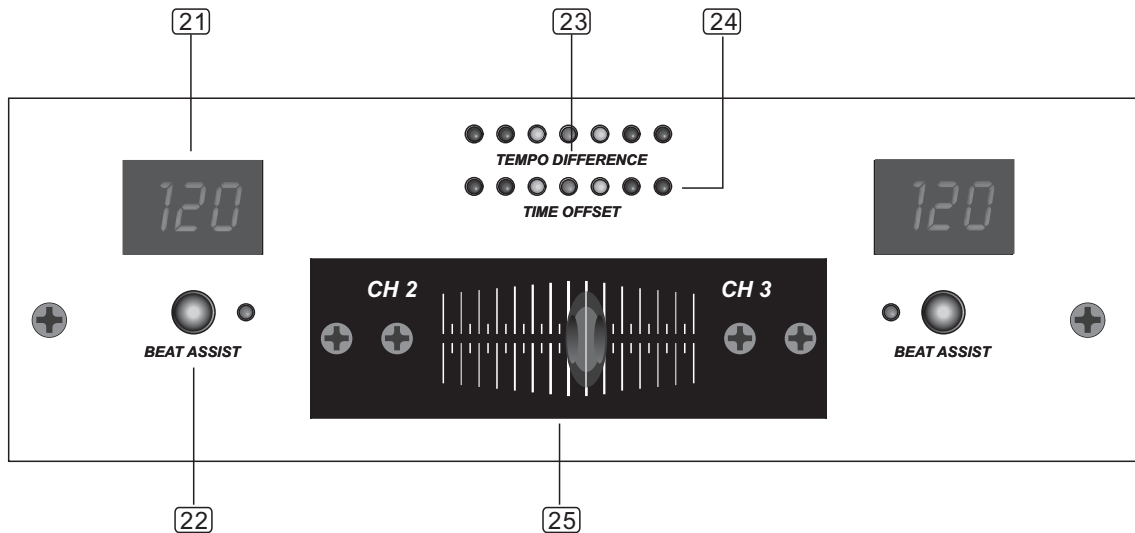

This is a key and exclusive function in your DJM 4 mixer. What is the Beat Per Minute function/ It simply indicate the "speed" of the music through a 3-digit display. The beats (per minute) of the music are automatically measured by the BPM and then displayed on the 3-digit display. Of course the two BPM counters are available for CH 2 and CH 3. Thanks to the BPM function you can mix more quickly songs with different tempo.

- The TEMPO Display 21

This 3-digit display will show the tempo of CH 2 and CH 3. If the tempo changes the display will change accordingly.

- The BEAT ASSIST switch 22

The Beat Assist button is available for CH 2 and CH 3 and it is below the Tempo display. Press the Beat Assist button and you can manually regulate the beat. The Led nearby the Beat Assist button will show you whether the function is active or not.

- TEMPO DIFFERENCE Led segment 23

This 7 segments Led Meter will indicate the difference in tempo between the CH 2 and CH 3 or programs. If the tempos on both channels are the same, the center LED will light. If the tempo of the music on channel 2 is faster, the LED's on the left will start to light and vice-versa.

- TIME OFFSET Led segment 24

This 7-segment Led Meter is positioned immediately below the Tempo Difference display. This display will indicate the synchronicity of the CH 2 and CH 3. When the two channels are synchronized, the center LED will light. If LED's on the left will start to light, Channel 2 is getting out of sync and vice-versa.

- The CROSSFADER 25

Through this crossfader you can fade in between CH 2 and CH 3. The Crossfader on your DJM 4 is VCA (Voltage Control Amplifier) controlled and it is User replaceable.

3.2 The Front Panel

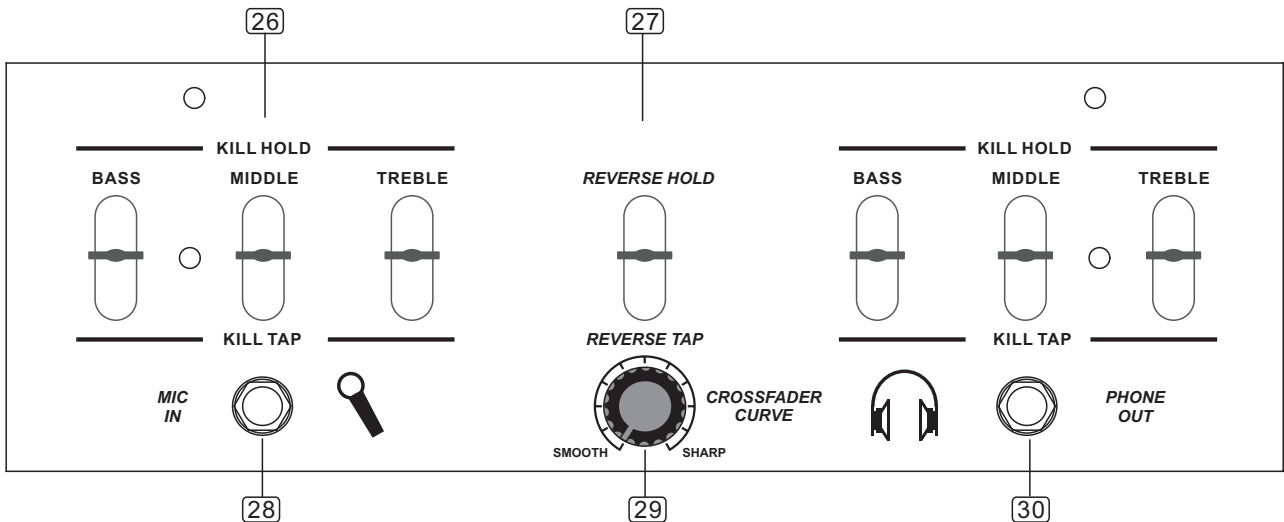

3.2.1 The KILL Function 26

The KILL function is used to attenuate the three frequency bands: BASS, MIDDLE and TREBLE. There are three modes: TAP, CENTER and HOLD.

There isn't KILL function in the CENTER position;

In TAP position, the function is triggered instantly and the switch will return to the center position as soon as you release it.

In HOLD position, the function will be locked in the HOLD position. To cancel the effect you will need to push back the switch in the center position.

The left and right KILL function are assigned to the CH 2 and CH 3 respectively. There is no KILL function for CH 1.

3.2.2 The REVERSE Function 27

Like the KILL function, there are three modes for the REVERSE function (TAP, CENTER and HOLD). It is used to invert the direction of the crossfader so that an immediate inversion of CH 2 and CH 3 will be achieved.

3.2.3 MIC IN Jack 28

This input will accept any unbalanced low impedance microphone. The functions of the microphone will be controlled by the CHANNEL section on the Top Panel.

3.2.4 CROSSFADER CURVE Control 29

Via this knob you will adjust the crossfader curve. Please see (8) earlier in this Manual for further reference.

3.2.5 The PHONE OUT Jack 30

This input will accept a standard headphone with a 1/4" stereo jack.

3.3 The Rear Panel

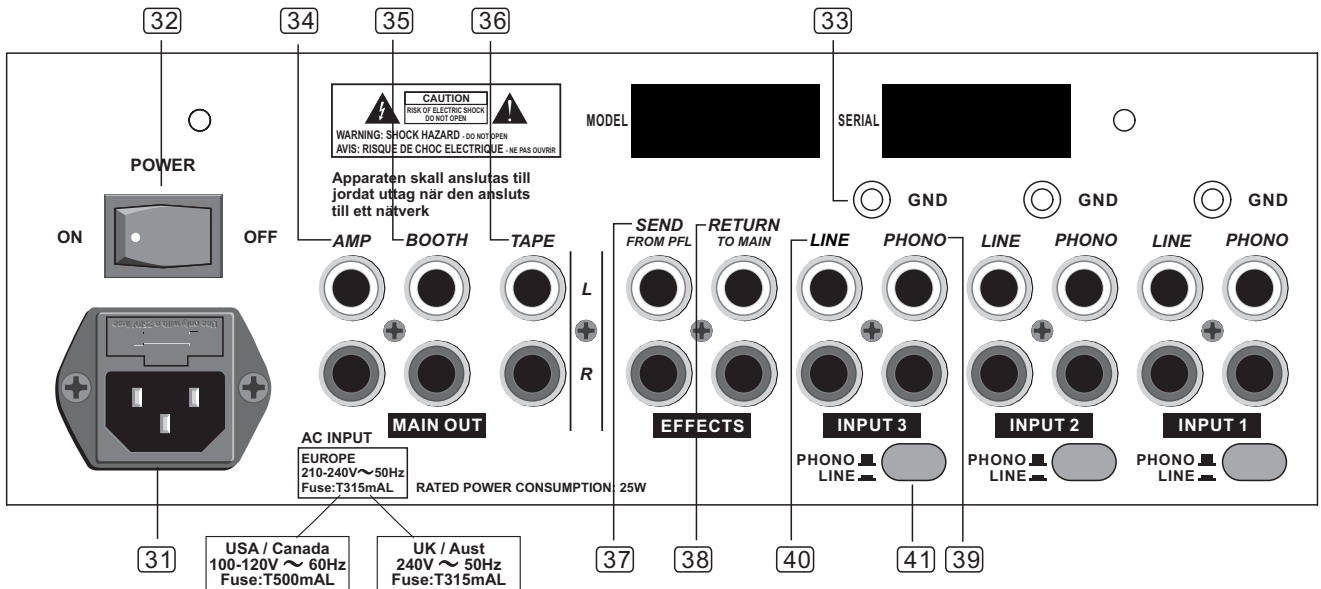

3.3.1 AC Inlet and Fuse Holder (31)

Use it to connect your DJM 4 to the Main AC with the supplied AC cord. Please check the Voltage available in your Country and make sure the voltage is identical to the values marking on the product. Replace the fuse with the same type by the qualified personnel only.

3.3.2 POWER Switch (32)

This switch turns the Mixer ON and OFF.

3.3.3 GND Screw (33)

GND is the supplementary grounding selection for other connected instruments.

3.3.4 The MAIN OUT

The AMP, BOOTH and TAPE outputs are RCA type connectors. Yes the same largely used in hi-fi and are low impedance.

Through the AMP output (34), you can connect your DJM 4 to an amplifier, and the level will be controlled by OUT A on the Top panel;

Through the BOOTH output (35), you can connect your DJM 4 to an additional amplifier and/or loudspeaker system and the level will be controlled by OUT B on the Top panel;

Through the TAPE output (36), you can connect your DJM 4 to a tape recorder. The TAPE level is fixed, so you should adjust the input level of the recorder.

3.3.5 EFFECTS Send and Return

You can send the PFL signal through the SEND (37) sockets to a signal processor such as reverb, equaliser, etc.. Then from the same effect unit you bring the signal back into the DJM 4 via the RETURN (38) sockets and the audio signal is routed into the MAIN output.

3.3.6 INPUT

- PHONO input (39): The three Channels feature PHONO inputs including RIIA preamplifier for turntable. PIN (RCA) jacks shall be used to connect the turntable.

- LINE input (40): Through these RCA type sockets you can connect a CD player, an MD player or any other high level device such as Tape Recorder, DAT, etc..

Important Notice: If you wish to connect LINE level devices into the LINE/PHONO input, make sure that the LINE/PHONO switch (41) is on LINE position otherwise the sensitive RIIA preamplifier built-in in the Phono input will be overloaded and will produce distortion.

4. TECHNICAL SPECIFICATIONS

INPUTS		
	Phono Inputs 1,2 and 3	40dB gain@1kHz,unbalanced
	Line Inputs 1,2 and 3	0dB gain, unbalanced
	Mic Input	40dB gain, servo-balanced
	Return	0dB gain, unbalanced
OUTPUTS		
	Headphones	typically 125mW@ 1% THD
	Main Out	max +21dBu
	Booth Out	max +21dBu
	Tape Out	typically 0dBu
	Send	typically 0dBu
GENERAL		
	Stereo Bass	+15dB/ - 30dB@ 50Hz
	Stereo Middle	+15dB/ - 30dB@2.5KHz
	Stereo Treble	+15dB/ - 30dB@10KHz
	Kill Bass	- 54dB@50Hz
	Kill Middle	- 40dB@1KHz
	Kill Treble	- 26dB@10KHz
	Signal - to - Noise ratio(S/N)	>90dB(LINE)
	Crosstalk	70dB ± 3dB(LINE)
	Distortion(THD)	< 0.05%
	Frequency Response	20Hz - 20KHz (±2dB)
	Input Gain Adjustment	- 20dB - +9dB (+3dB)
POWER SUPPLY		
	Connector type	3 - pole IEC, grounded
	Main Voltage	USA/Canada100 - 120V~, 60Hz
		Europe210 - 230V~, 50Hz
		U.K./Australia240V~, 50Hz
	Power Consumption	25watts
	Fuse	95 - 120V~ : T500mAL
		210 - 240V~ : T315mAL
DIMENSIONS and WEIGHT		
	Dimension	248(L)×245(W)×76.6(H)mm (9.8"×9.6"×3.0")
	Weight	2.9Kg (6.39lb)

5. SYSTEM BLOCK DIAGRAM

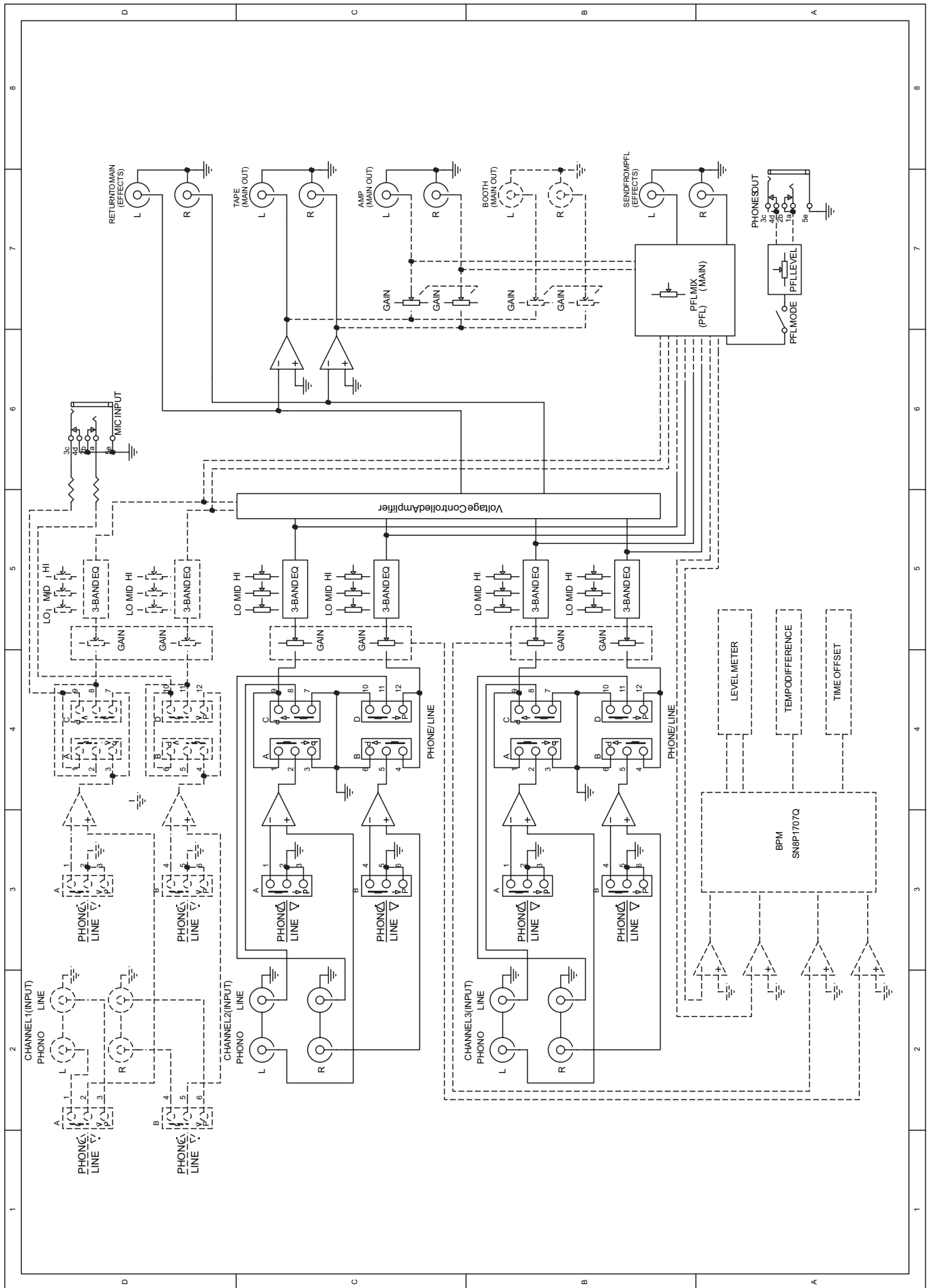

6. WARRANTY

1. WARRANTY REGISTRATION CARD

To obtain Warranty Service, the buyer should first fill out and return the enclosed Warranty Registration Card within 10 days of the Purchase Date.

All the information presented in this Warranty Registration Card gives the manufacturer a better understanding of the sales status, so as to purport a more effective and efficient after-sales warranty service.

Please fill out all the information carefully and genuinely, miswriting or absence of this card will void your warranty service.

2. RETURN NOTICE

2.1 In case of return for any warranty service, please make sure that the product is well packed in its original shipping carton, and it can protect your unit from any other extra damage.

2.2 Please provide a copy of your sales receipt or other proof of purchase with the returned machine, and give detail information about your return address and contact telephone number.

2.3 A brief description of the defect will be appreciated.

2.4 Please prepay all the costs involved in the return shipping, handling and insurance.

3. TERMS AND CONDITIONS

3.1 ▲LTO warrants that this product will be free from any defects in materials and/or workmanship for a period of 1 year from the purchase date if you have completed the Warranty Registration Card in time.

3.2 The warranty service is only available to the original consumer, who purchased this product directly from the retail dealer, and it can not be transferred.

3.3 During the warranty service, ▲LTO may repair or replace this product at its own option at no charge to you for parts or for labor in accordance with the right side of this limited warranty.

3.4 This warranty does not apply to the damages to this product that occurred as the following conditions:

- Instead of operating in accordance with the user's manual thoroughly, any abuse or misuse of this product.
- Normal tear and wear.
- The product has been altered or modified in any way.
- Damage which may have been caused either directly or indirectly by another product / force / etc.
- Abnormal service or repairing by anyone other than the qualified personnel or technician.

And in such cases, all the expenses will be charged to the buyer.

3.5 In no event shall ▲LTO be liable for any incidental or consequential damages. Some states do not allow the exclusion or limitation of incidental or consequential damages, so the above exclusion or limitation may not apply to you.

3.6 This warranty gives you the specific rights, and these rights are compatible with the state laws, you may also have other statutory rights that may vary from state to state.

SEIKAKU TECHNICAL GROUP LIMITED
No. 1, Lane 17, Sec. 2, Han Shi West Road, Taichung 40151 Taiwan
<http://www.altoproaudio.com> Tel: 886-4-22313737
email: alto@altoproaudio.com Fax: 886-4-22346757

All rights reserved to ALTO. All features and content might be changed without prior notice. Any photocopy, translation, or reproduction of part of this manual without written permission is forbidden. Copyright © 2005 SEIKAKU GROUP